

1101506

RESISTENZA CON SICUREZZA 400V 6,0 KW

Data: 03-05-2025



ORIGINAL
OSP
SPARE PARTS

Dati tecnici

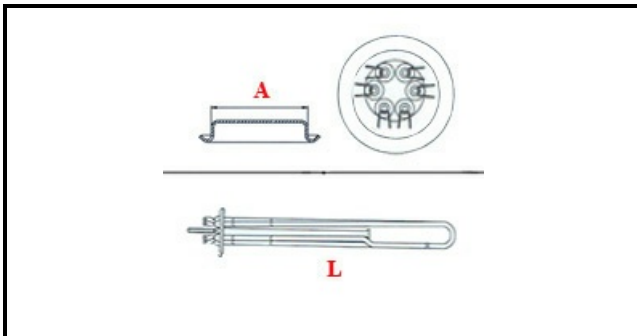

LUNGHEZZA MM	L=290mm
NR ELEMENTI	ELEMENTI/ELEMENTS=3
FLANGIA TONDA	TONDA/ROUND FLANGE=47mm
DIAMETRO mm	A=47mm
KILOWATT KW	KW=6
WATT	WATT=6000
TRIFASE	TRIFASE/THREEPHASE
NUMERO POLI	POLI/POLES=6
GUARNIZIONE	2101032
RESISTENZE PER IMMERSIONE	IMMERSIONE/IMMERSION

Codici produttore

WINTERHALTER ITALIA SRL
WINTERHALTER ITALIA SRL
WINTERHALTER ITALIA SRL
WINTERHALTER ITALIA SRL