

1101089

TANK HEATING ELEMENT 3500W 230V MARENO

Date: 16-06-2025



ORIGINAL
OSP
SPARE PARTS

Technical data

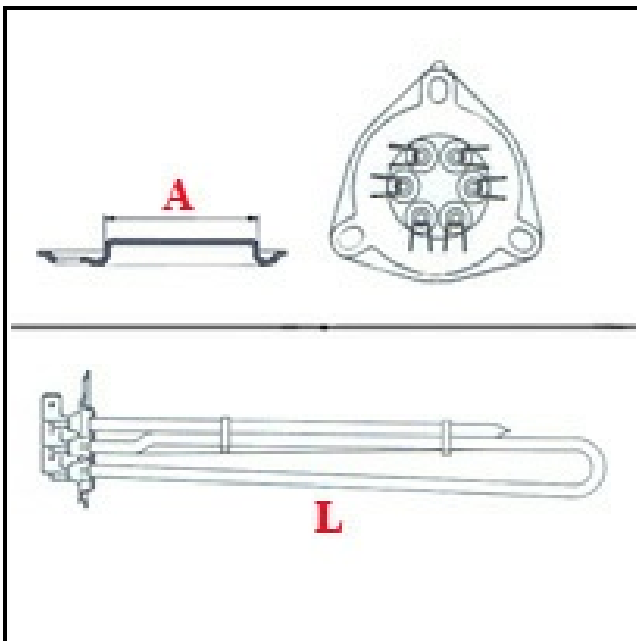

DEPTH MM	L=350mm
ELEMENTS	ELEMENTI/ELEMENTS=3
TRIANGULAR FLANGE	TRIANGOLARE/TRIANGULAR FLANGE=57mm
DIAMETER mm	A=57mm
WATT	KW=3,5
AMPERE - A	WATT=3500
THREE PHASE	TRIFASE/THREEPHASE
NUMBER OF POLES	POLI/POLES=6
NUMBER OF HOLES	FORI/HOLES=3
GASKET	2101033
IMMERSION HEATING ELEMENTS	IMMERSIONE/IMMERSION ELEMENTS

Manufacturer code

LASA SRL

MARENO ALI GROUP SRL A SOCIO UNICO