

S&P



Coffee

Coffee Catalogue 2017



S&P

**Corso Sempione 238/8
21052 Busto Arsizio (VA)
ITALY**

phone: +39.0331.324053



fax: +39.0331.671063



Come ordinare, how to order, comment commander, Wie konnes Sie bestellen, Como ordinar :

Phone: +39.0331.324053

Fax : +39.0331.671063

E-mail: info.sep-spareparts.com

Ricambi fuori catalogo

preghiamo, nel limite del possibile, di fornire i seguenti dati:

- Nome del costruttore
- Modello dell'apparecchiatura
- Numero matricola ed anno costruzione

Spare parts out of catalogue

Please give us the following data:

- Manufacturer's name
- Machine's model
- Serial number and manufacture year

Pièces hors catalogue

Veuillez nous fournir les données suivantes :

- Nome du constructeur
- Model de la machine
- Numéro de série et année de fabrication

Ersatzteile, die im Katalog nicht enthalten sind

Im Rahmen des Möglichen, bitten wir Sie, um folgenden daten uns mitzuteilen und zwar:

- Name des Herstellers
- Maschinenmodell
- Fabriknummer und Herstellungsjahr

Repuestos fuera del catalogo

Les pedimos que en el limite de lo posible proporcionar los siguientes datos:

- Nombre del constructor
- Modelo del aparato
- Numero de matricula y año de construcción

In questo catalogo sono raffigurati i materiali più rappresentativi e di maggior importanza; a richiesta sono disponibili gli articoli specifici per i marchi più diffusi.

This catalogue shows the most representative and important materials; at request, the specific items of the well-known stamps are available.

Ce catalogue montre les matériels plus représentatifs et de majeure importance; à requête, les articles spécifiques des maisons plus connues sont disponibles.

In diesem Katalog sind die wichtigsten Artikel dargestellt; auf Wunsch sind bestimmte Artikel der meistverbreitesten Firmen verfügbar.

En este catalogo se presentan los materiales más representativos y de mayor importancia; sobre pedido están disponibles los artículos específicos de las marcas más conocidas.

Le informazioni contenute in questo catalogo sono soggette a modifiche senza preavviso.

Nessuna parte di questo catalogo può essere riprodotta in qualsiasi forma o mezzo elettronico o meccanico, per alcun uso, senza il permesso scritto della S&P.

The information you find in this catalogue can be modified without advise.

This catalogue cannot be reproduced in any form and electronic or mechanical means without the express written authorisation of S&P.

Les reinsegnements de ce catalogue peuvent être modifiés sans avis.

Ce catalogue ne peut pas être reproduit avec n'importe quelle forme ou moyen électronique ou mécanique sans autorisation écrite exprimée de la S&P.

Die in diesem Katalog enthaltenen Angaben können ohne Vorbehalten geändert werden.

Ohne schriftliche Genehmigung von der Firma S&P, kann keine Seite von diesem Handbuch entweder elektronisch oder mechanisch für kein Ziel vervielfältigt werden.

Las informaciones contenidas en este catalogo estan sujetas a modificaciones sin pre aviso.

Ninguna parte de este catalogo puede ser reproducida en cualquier forma o medio electrónico o mecánico para algún uso sin el permiso escrito de la S&P.

Condizioni generali

Prezzi: Le quotazioni espresse nei listini si intendono indicative e possono essere soggette a variazioni senza preavviso.

I prezzi non comprendono spese di trasporto, imballaggio, IVA ed eventuali altri oneri accessori; le spese per emissione di ricevute bancarie e tratte sono a carico del Cliente.

Resa della merce: Il materiale si intende venduto franco ns. magazzino, e pertanto l'obbligo di fornitura si intende assolto con la presa in consegna della merce da parte del trasportatore. La merce viaggia sempre, anche in caso di porto franco destino, a rischio e pericolo del Committente e, salvo precise disposizioni da parte del medesimo, l'inoltro della merce a destino verrà effettuato nel modo da noi ritenuto più idoneo, senza che ciò comporti alcuna responsabilità da parte della S&P, che non potrà essere ritenuta responsabile di eventuali ritardi o disguidi causati dal vettore.

Reclami: La S&P agisce quale rivenditore di materiali prodotti da terzi, non può pertanto assumersi responsabilità riferita ad eventuali difetti degli stessi. Qualsiasi reclamo dovrà essere indirizzato ad S&P con lettera o fax entro e non oltre otto (8) giorni dal ricevimento della merce.

Responsabilità: La S&P non si assume nessuna responsabilità per quanto riguarda i dati tecnici e le caratteristiche riportate nei propri cataloghi, né per le variazioni che le singole case costruttrici dovessero apportare.

Sale terms

Prices: The prices are indicative and can be changed without advice.

The costs of transport, packaging and eventual charges are not included in the prices.

Delivery terms: Ex-works

Complaints: S&P is a reseller so is not responsible for material defects. Every complaint has to be sent to S&P by fax or letter within 8 days on receipt of the goods.

Responsability: The S&P is not responsible for technic data or manufacture changes indicate in the catalogue.

Conditions générales de vente

Prix: Les prix sont indicatifs et peuvent être sujets à modifications sans avis. Ils ne comprennent costs de transport, emballage et charges eventuelles.

Délais de livraison: Ex-works.

Réclamations: La S&P est revendeur de matériel de tiers donc ne peut pas être responsable de eventuels défauts de fabrication. Les réclamations doivent être envoyées par fax ou lettre dans 8 jours de reception de la marchandise.

Responsabilité : La S&P n'est pas responsable pour les données techniques indiquées dans le catalogue ainsi que les variations faites des constructeurs.

Allgemeine Bedingungen

Preise: Die in unserer Liste angegebenen Preise können ohne Vorankündigung geändert werden. Transportkosten, Verpackung und eventuelle zusätzlichen Kosten sind in den Preisen nicht inbegriffen.

Lieferung: Ex-works.

Reklamationen: Eventuelle Reklamationen müssen schriftlich direkt an die Firma S&P innerhalb von 8 Tagen nach Warenerhalt vorgebracht werden.

Verantwortlichkeit: Die Richtigkeit der im katalog von verschiedenen Herstellern angegebenen technischen Angaben und Maße sind ohne Gewähr.

Condiciones generales

Precios: La cotizaciones espuestas en la lista se entienden indicativas y pueden ser sujetas a variaciones sin preaviso.

Los precios no comprenden gastos de transporte, embalaje y eventuales gastos accesorios.

Devolucion de la mercaderia: Ex-works.

Reclamos: La S&P actua como revendedor de materiales producidos por terceros, portanto no puede asumirse responsabilidad referida a eventuales defectos de los mismos productos. Cualquier reclamo tendrá que ser indirisado a la S&P con carta o fax entre y no depues de 8 dias del recevimiento de la mercanti

Responsabilidad: La S&P no se asume ninguna responsabilidad por quanto reguarda los datos tecnicos y las características reportadas en los propios catalogos ni por las variaciones que la singulas casas constructoras trendrian che aportar.

Coffee 2017 INDEX

Description	Cod.	Example					Page
Articoli complementari / Compl. Items	----						191
Addolcitori / Water softners	6101						174
Bruciatori / Burners	4111						153
Candele accensione / Candles	4102						153
Cappuccinatori / Cappuccinatori	1119						94
Cavi elettrici / Cables	1128						153
Centraline elettroniche / P.C. Boards	1114						113
Commutatori / Commutators	1115						142
Complementi tecnici / Technical complements	1143						37
Condensatori / Capacitors	1135						36
Doccette / Coffee-machine showers	1111						40
Elementi sensibili / Sensitive elements	1129						127
Elettropompe / Pumps	1103					32	
Elettrovalvole / Solenoid valves	1124						97
Filtri / Filters	3126						46



Coffee 2017 INDEX

Description	Cod.	Example					Page
Giranti / Fans/Rods	3109						128
Guarnizioni O-Ring / O-ring gaskets	2101						f 63
Guarnizioni piatte / Flat gaskets	2102						55
Guarnizioni teflon / Teflon gaskets	2107						58
Interruttori / Switches	1105						133
Macine / Grinders	1120						167
Manometri / Manometers	1110						85
Manopole / Handles	3108						82
Micro-interruttori / Micro-switches	1107						123
Molle / Springs	1117						87
Motoriduttori / Moto-reducers	1134						34
Piedini / Feet	3105						162
Piezolettrici / Piezoelectric starters	1132						153
Pompanti / Pumping elements	1133						34
Portafiltri / Filter-holders	1116						74

Coffee 2017 INDEX

Description	Cod.	Example					Page
Presso stati / Pressure switches	1113						104
Pulsanti / Push buttons	1108						136
Raccorderia / Junctions/ nipples	1125						164
Raccordi / Junctions	3118						164
Relè-contattori / Relays - Contactors	1109						108
Resistenze / Heating elements	1101						20
Rubinetti / Cocks	4127						90
Rubinetti gas / Gas Cocks	4130						154
Segnalatori luminosi / Lamps	1104						129
Termocoppie / Thermocouples	4101						149
Termostati / Thermostats	1106						105
Timer / Timers	1112						112
Tramogge / Hoppers	1121						178
Tubi di carico / Load pipes	2110						144
Tubi scarico / Drain pipes	2109						145
Tubi vapore / Steam pipes	1118						95

Coffee 2017 INDEX

Description	Cod.	Example	Page
Vari macchina per caffè / Parts for coffee machines	4116		154
Vari Macinacaffè / Parts for grinders	4118		180
Vetri / Glasses	1139		166

CONTROLLO DELLE DIMENSIONI O-RINGS

MEASUREMENT OF THE O-RINGS SIZES

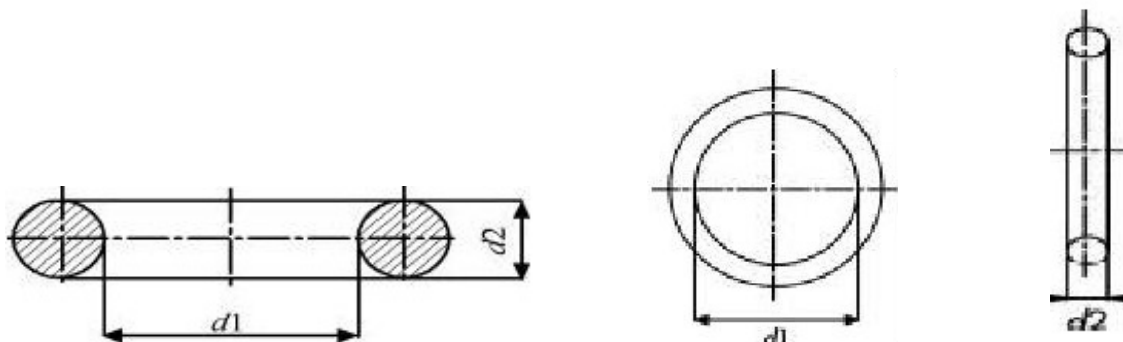

d1: diametro interno
d1: internal diameter
d1: diamètre intérieur
d1: diámetro interior

d2: spessore OR (diametro della corda)
d2: OR thickness (torus)
d2: épaisseur OR
d2: OR espesor

-Il controllo di D1 e D2 viene fatto in base alle tolleranze della tabella ISO 3601 (ex DIN 3771) parte 1.

-The measurement of D1 and D2 is carried out on the basis of the tolerances of the table ISO 3601 (ex DIN 3771) part 1.

Esempio di misurazione delle OR: codice **2101303**: (d1) 3,69 x (d2) 1,78

How to measure O-Rings: example code **2101303**: (d1) 3,69 x (d2) 1,78

d1: 3,69 diametro interno OR/ OR internal diameter

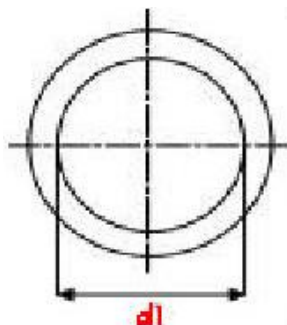

d2: 1,78 diametro della corda OR/OR thickness (torus)

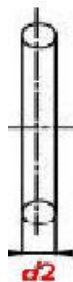

S&P O-RINGS NBR

Codice/Code	Descrizione/Description d1xd2	Codice/Code	Descrizione/Description d1xd2
2101300	1,78X1,78 O-RING	2101346	88,64X1,78 O-RING
2101301	2,57X1,78 O-RING	2101347	91,70X1,78 O-RING
2101302	2,90X1,78 O-RING	2101348	95,00X1,78 O-RING
2101303	3,69X1,78 O-RING	2101349	98,05X1,78 O-RING
2101304	4,47X1,78 O-RING	2101350	101,34X1,78 O-RING
2101305	5,28X1,78 O-RING	2101351	104,40X1,78 O-RING
2101306	6,07X1,78 O-RING	2101352	107,70X1,78 O-RING
2101307	6,35X1,78 O-RING	2101353	114,00X1,78 O-RING
2101308	6,75X1,78 O-RING	2101354	117,10X1,78 O-RING
2101309	7,66X1,78 O-RING	2101355	120,40X1,78 O-RING
2101310	8,73X1,78 O-RING	2101356	133,10X1,78 O-RING
2101311	9,25X1,78 O-RING	2101357	142,11X1,78 O-RING
2101312	10,82X1,78 O-RING	2101358	161,16X1,78 O-RING
2101313	11,11X1,78 O-RING	2101359	164,34X1,78 O-RING
2101314	12,42X1,78 O-RING	2101360	2,20X1,90 O-RING
2101315	14,00X1,78 O-RING	2101361	2,40X1,90 O-RING
2101316	15,60X1,78 O-RING	2101362	2,60X1,90 O-RING
2101317	17,16X1,78 O-RING	2101363	3,40X1,90 O-RING
2101318	18,77X1,78 O-RING	2101364	4,20X1,90 O-RING
2101319	20,35X1,78 O-RING	2101365	4,90X1,90 O-RING
2101320	21,95X1,78 O-RING	2101366	5,70X1,90 O-RING
2101321	23,52X1,78 O-RING	2101367	6,40X1,90 O-RING
2101322	25,12X1,78 O-RING	2101368	7,20X1,90 O-RING
2101323	26,70X1,78 O-RING	2101369	8,00X1,90 O-RING
2101324	28,30X1,78 O-RING	2101370	8,90X1,90 O-RING
2101325	29,87X1,78 O-RING	2101371	2,84X2,62 O-RING
2101326	31,47X1,78 O-RING	2101372	3,63X2,62 O-RING
2101327	33,05X1,78 O-RING	2101373	4,42X2,62 O-RING
2101328	34,65X1,78 O-RING	2101374	5,23X2,62 O-RING
2101329	36,27X1,78 O-RING	2101375	6,02X2,62 O-RING
2101330	37,82X1,78 O-RING	2101376	7,60X2,62 O-RING
2101331	39,45X1,78 O-RING	2101377	9,13X2,62 O-RING
2101332	41,00X1,78 O-RING	2101378	9,19X2,62 O-RING
2101333	44,17X1,78 O-RING	2101379	9,92X2,62 O-RING
2101334	47,37X1,78 O-RING	2101380	10,78X2,62 O-RING
2101335	50,52X1,78 O-RING	2101381	11,91X2,62 O-RING
2101336	53,67X1,78 O-RING	2101382	12,37X2,62 O-RING
2101337	56,87X1,78 O-RING	2101383	13,10X2,62 O-RING
2101338	60,04X1,78 O-RING	2101384	13,95X2,62 O-RING
2101339	63,22X1,78 O-RING	2101385	15,08X2,62 O-RING
2101340	66,40X1,78 O-RING	2101386	15,54X2,62 O-RING
2101341	69,57X1,78 O-RING	2101387	15,88X2,62 O-RING
2101342	72,76X1,78 O-RING	2101388	17,13X2,62 O-RING
2101343	75,94X1,78 O-RING	2101389	17,86X2,62 O-RING
2101344	79,00X1,78 O-RING	2101390	18,72X2,62 O-RING
2101345	82,28X1,78 O-RING	2101391	20,29X2,62 O-RING



S&P O-RINGS NBR

Codice/Code	Descrizione/Description d1xd2	Codice/Code	Descrizione/Description d1xd2
2101392	20,64X2,62 O-RING	2101438	139,38X2,62 O-RING
2101393	21,90X2,62 O-RING	2101439	145,73X2,62 O-RING
2101394	22,23X2,62 O-RING	2101440	152,07X2,62 O-RING
2101395	23,47X2,62 O-RING	2101441	158,43X2,62 O-RING
2101396	23,81X2,62 O-RING	2101442	164,78X2,62 O-RING
2101397	25,07X2,62 O-RING	2101443	171,13X2,62 O-RING
2101398	26,65X2,62 O-RING	2101444	177,48X2,62 O-RING
2101399	28,25X2,62 O-RING	2101445	183,83X2,62 O-RING
2101400	29,83X2,62 O-RING	2101446	196,53X2,62 O-RING
2101401	31,42X2,62 O-RING	2101447	202,88X2,62 O-RING
2101402	33,00X2,62 O-RING	2101448	209,23X2,62 O-RING
2101403	34,60X2,62 O-RING	2101449	221,93X2,62 O-RING
2101404	36,17X2,62 O-RING	2101450	228,28X2,62 O-RING
2101405	37,77X2,62 O-RING	2101451	234,63X2,62 O-RING
2101406	39,35X2,62 O-RING	2101452	240,98X2,62 O-RING
2101407	40,95X2,62 O-RING	2101453	8,90X2,70 O-RING
2101408	42,52X2,62 O-RING	2101454	10,50X2,70 O-RING
2101409	44,12X2,62 O-RING	2101455	12,10X2,70 O-RING
2101410	45,70X2,62 O-RING	2101456	13,60X2,70 O-RING
2101411	47,30X2,62 O-RING	2101457	15,10X2,70 O-RING
2101412	48,90X2,62 O-RING	2101458	16,90X2,70 O-RING
2101413	50,47X2,62 O-RING	2101459	18,40X2,70 O-RING
2101414	52,07X2,62 O-RING	2101460	4,34X3,53 O-RING
2101415	53,65X2,62 O-RING	2101461	7,52X3,53 O-RING
2101416	55,25X2,62 O-RING	2101462	9,12X3,53 O-RING
2101417	56,82X2,62 O-RING	2101463	15,47X3,53 O-RING
2101418	58,42X2,62 O-RING	2101464	18,64X3,53 O-RING
2101419	60,00X2,62 O-RING	2101465	20,22X3,53 O-RING
2101420	61,60X2,62 O-RING	2101466	21,82X3,53 O-RING
2101421	63,17X2,62 O-RING	2101467	23,40X3,53 O-RING
2101422	64,77X2,62 O-RING	2101468	25,00X3,53 O-RING
2101423	66,35X2,62 O-RING	2101469	25,80X3,53 O-RING
2101424	67,95X2,62 O-RING	2101470	26,57X3,53 O-RING
2101425	69,52X2,62 O-RING	2101471	28,17X3,53 O-RING
2101426	71,12X2,62 O-RING	2101472	29,75X3,53 O-RING
2101427	72,70X2,62 O-RING	2101473	31,34X3,53 O-RING
2101428	75,88X2,62 O-RING	2101474	32,93X3,53 O-RING
2101429	80,60X2,62 O-RING	2101475	34,52X3,53 O-RING
2101430	82,22X2,62 O-RING	2101476	36,10X3,53 O-RING
2101431	88,58X2,62 O-RING	2101477	37,70X3,53 O-RING
2101432	94,93X2,62 O-RING	2101478	39,70X3,53 O-RING
2101433	101,28X2,62 O-RING	2101479	40,87X3,53 O-RING
2101434	113,98X2,62 O-RING	2101480	41,28X3,53 O-RING
2101435	120,33X2,62 O-RING	2101481	42,86X3,53 O-RING
2101436	126,67X2,62 O-RING	2101482	44,05X3,53 O-RING
2101437	133,00X2,62 O-RING	2101483	44,45X3,53 O-RING

S&P O-RINGS NBR

Codice/Code	Descrizione/Description d1xd2	Codice/Code	Descrizione/Description d1xd2
2101484	46,04X3,53 O-RING	2101530	139,30X3,53 O-RING
2101485	47,23X3,53 O-RING	2101531	142,47X3,53 O-RING
2101486	47,62X3,53 O-RING	2101532	145,65X3,53 O-RING
2101487	49,20X3,53 O-RING	2101533	148,82X3,53 O-RING
2101488	50,40X3,53 O-RING	2101534	152,00X3,53 O-RING
2101489	50,80X3,53 O-RING	2101535	158,35X3,53 O-RING
2101490	52,40X3,53 O-RING	2101536	164,70X3,53 O-RING
2101491	53,57X3,53 O-RING	2101537	171,05X3,53 O-RING
2101492	53,97X3,53 O-RING	2101538	177,40X3,53 O-RING
2101493	55,56X3,53 O-RING	2101539	183,75X3,53 O-RING
2101494	56,75X3,53 O-RING	2101540	190,10X3,53 O-RING
2101495	57,15X3,53 O-RING	2101541	196,45X3,53 O-RING
2101496	58,74X3,53 O-RING	2101542	202,80X3,53 O-RING
2101497	59,92X3,53 O-RING	2101543	209,15X3,53 O-RING
2101498	60,32X3,53 O-RING	2101544	215,50X3,53 O-RING
2101499	61,90X3,53 O-RING	2101545	221,85X3,53 O-RING
2101500	63,10X3,53 O-RING	2101546	228,20X3,53 O-RING
2101501	65,10X3,53 O-RING	2101547	234,55X3,53 O-RING
2101502	66,27X3,53 O-RING	2101548	240,90X3,53 O-RING
2101503	66,67X3,53 O-RING	2101549	247,25X3,35 O-RING
2101504	68,26X3,53 O-RING	2101550	253,60X3,53 O-RING
2101505	69,85X3,53 O-RING	2101551	266,30X3,53 O-RING
2101506	71,44X3,53 O-RING	2101552	279,00X3,53 O-RING
2101507	69,44X3,53 O-RING	2101553	291,70X3,53 O-RING
2101508	72,62X3,53 O-RING	2101554	304,40X3,53 O-RING
2101509	73,02X3,53 O-RING	2101555	329,80X3,53 O-RING
2101510	74,60X3,53 O-RING	2101556	355,20X3,53 O-RING
2101511	75,80X3,53 O-RING	2101557	380,60 X3,53 O-RING
2101512	78,97X3,53 O-RING	2101558	405,26X 3,53 O-RING
2101513	82,14X3,53 O-RING	2101559	430,66X3,53 O-RING
2101514	85,32X3,53 O-RING	2101560	18,30X3,60 O-RING
2101515	88,50X3,53 O-RING	2101561	19,80X3,60 O-RING
2101516	91,67X3,53 O-RING	2101562	21,30X3,60 O-RING
2101517	94,84X3,53 O-RING	2101563	23,00X3,60 O-RING
2101518	101,2X3,53 O-RING	2101564	24,60X3,60 O-RING
2101519	104,37X3,53 O-RING	2101565	26,20X3,60 O-RING
2101520	107,54X3,53 O-RING	2101566	27,80X3,60 O-RING
2101521	110,72X3,53 O-RING	2101567	29,30X3,60 O-RING
2101522	113,90X3,53 O-RING	2101568	30,80X3,60 O-RING
2101523	117,07X3,53 O-RING	2101569	32,50X3,60 O-RING
2101524	120,24X3,53 O-RING	2101570	34,10X3,60 O-RING
2101525	123,42X3,53 O-RING	2101571	35,60X3,60 O-RING
2101526	126,60X3,53 O-RING	2101572	37,30X3,60 O-RING
2101527	129,77X3,53 O-RING	2101573	16,81X5,34 O-RING
2101528	132,94X3,53 O-RING	2101574	18,42X5,34 O-RING
2101529	136,12X3,53 O-RING	2101575	24,77X5,34 O-RING

S&P O-RINGS NBR

Codice/Code	Descrizione/Description d1xd2	Codice/Code	Descrizione/Description d1xd2
2101576	27,94X5,34 O-RING	2101625	142,24X5,34 O-RING
2101577	29,51X 5,34 O-RING	2101626	142,88X5,34 O-RING
2101578	31,12X5,34 O-RING	2101627	145,42X5,34 O-RING
2101579	34,29X5,34 O-RING	2101628	146,05X5,34 O-RING
2101581	40,65X5,34 O-RING	2101629	148,60X5,34 O-RING
2101582	43,82X5,34 O-RING	2101630	149,23X5,64 O-RING
2101584	50,16X5,34 O-RING	2101631	151,77X5,34 O-RING
2101585	53,34X5,34 O-RING	2101632	158,12X5,34 O-RING
2101587	59,70X5,34 O-RING	2101633	164,47X5,34 O-RING
2101588	62,87X5,34 O-RING	2101634	170,82X5,34 O-RING
2101589	66,04X5,34 O-RING	2101635	177,17X5,34 O-RING
2101590	69,22X5,34 O-RING	2101636	183,52X5,34 O-RING
2101591	72,40X5,34 O-RING	2101637	189,87X5,34 O-RING
2101592	74,63X5,34 O-RING	2101638	196,22X5,34 O-RING
2101593	75,57X5,34 O-RING	2101639	202,57X5,34 O-RING
2101594	78,74X5,34 O-RING	2101640	208,92X5,34 O-RING
2101595	79,77X5,34 O-RING	2101641	215,27X5,34 O-RING
2101596	81,92X5,34 O-RING	2101642	221,62X5,34 O-RING
2101597	85,10X5,34 O-RING	2101643	227,97X 5,34 O-RING
2101598	88,27X5,34 O-RING	2101644	278,77X5,34 O-RING
2101599	89,69X5,34 O-RING	2101645	291,47X5,34 O-RING
2101600	91,44X5,34 O-RING	2101646	304,17X5,34 O-RING
2101601	94,62X5,34 O-RING	2101647	380,37X5,34 O-RING
2101602	97,80X5,34 O-RING	2101648	405,26X5,34 O-RING
2101603	100,00X5,34 O-RING	2101649	430,66X5,34 O-RING
2101604	100,97X5,34 O-RING	2101650	481,46X5,34 O-RING
2101605	104,14X5,34 O-RING	2101651	113,67X6,99 O-RING
2101606	107,32X5,34 O-RING	2101652	114,70X6,99 O-RING
2101607	109,54X5,43 O-RING	2101653	116,84X6,99 O-RING
2101608	110,50X5,3 4 O-RING	2101654	120,02X6,99 O-RING
2101609	113,67,5,34 O-RING	2101655	123,20X6,99 O-RING
2101610	116,84X5,34 O-RING	2101656	124,60X6,99 O-RING
2101611	117,48X5,34 O-RING	2101657	126,37X6,99 O-RING
2101612	120,02X5,34 O-RING	2101658	129,54X6,99 O-RING
2101613	120,65X5,34 O-RING	2101659	132,72X6,99 O-RING
2101614	123,20X5,34 O-RING	2101660	134,50X6,99 O-RING
2101615	123,83X5,34 O-RING	2101661	135,90X6,99 O-RING
2101616	126,37X5,34 O-RING	2101662	139,07X6,99 O-RING
2101617	127,00X5,34 O-RING	2101663	142,24X6,99 O-RING
2101618	129,54X5,34 O-RING	2101664	145,42X6,99 O-RING
2101619	130,18X5,34 O-RING	2101665	148,60,X6,99 O-RING
2101620	132,72X5,34 O-RING	2101666	151,77X6,99 O-RING
2101621	133,35X5,34 O-RING	2101667	155,60X6,99 O-RING
2101622	135,90X5,34 O-RING	2101668	158,12X6,99 O-RING
2101623	136,53X5,34 O-RING	2101669	159,50X6,99 O-RING
2101624	139,70X5,34 O-RING	2101670	161,90X6,99 O-RING

S&P O-RINGS NBR

Codice/Code	Descrizione/Description d1xd2	Codice/Code	Descrizione/Description d1xd2
2101671	164,47X6,99 O-RING	2101717	98,02X3,53 O-RING
2101672	166,70X6,99 O-RING	2101118	37X1,5 O-RING
2101673	168,30X6,99 O-RING	2101119	58X1,5 O-RING
2101674	170,82X6,99 O-RING	2101132	2X9,5X13,5 O-RING
2101675	174,60X6,99 O-RING	2101137	1X7X9 O-RING
2101676	177,17X6,99 O-RING	2101151	6X3X12 O-RING
2101677	181,00X6,99 O-RING	2101152	81X87X3 O-RING
2101678	183,52X6,99 O-RING	2101153	43X49X3 O-RING
2101679	187,30X6,99 O-RING	2101156	70X94X2 O-RING
2101680	189,87X6,99 O-RING	2101187	13X2X17 O-RING
2101681	193,70X6,99 O-RING	2101231	28X2,5 O-RING
2101682	196,22X6,99 O-RING	2101031	37X5,33 O-RING
2101683	200,00X6,99 O-RING	2101032	46,99X5,33 O-RING
2101684	202,57X6,99 O-RING	2101033	56,52X5,33 O-RING
2101685	208,92X6,99 O-RING		
2101686	215,27X6,99 O-RING		
2101687	221,62X6,99 O-RING		
2101688	227,97X6,99 O-RING		
2101689	234,32X6,99 O-RING		
2101690	240,67X6,99 O-RING		
2101691	247,00X6,99 O-RING		
2101692	253,57X6,99 O-RING		
2101693	259,70X6,99 O-RING		
2101694	266,07X6,99 O-RING		
2101695	272,40X6,99 O-RING		
2101696	278,77X6,99 O-RING		
2101697	285,10X6,99 O-RING		
2101698	291,47X6,99 O-RING		
2101699	304,17X6,99 O-RING		
2101700	316,87X6,99 O-RING		
2101701	329,57X6,99 O-RING		
2101702	342,27X6,99 O-RING		
2101703	354,97X6,99 O-RING		
2101704	367,67X6,99 O-RING		
2101705	380,37X6,99 O-RING		
2101706	393,07X6,99 O-RING		
2101707	405,26X6,99 O-RING		
2101708	417,96X6,99 O-RING		
2101709	430,66X6,99 O-RING		
2101710	443,36X6,99 O-RING		
2101711	456,06X6,99 O-RING		
2101712	468,76X6,99 O-RING		
2101713	481,46X6,99 O-RING		
2101714	494,16X6,99 O-RING		
2101715	506,86X6,99 O-RING		
2101716	63,50X3,53 O-RING		



**NIPPLES DOPPIO MM
MALE-MALE NIPPLES**

CODICE-CODE	MISURA-SIZE
1125008	3/8
1125019	1/8
1125091	1/4
1125092	1/2
1125093	3/4



**NIPPLES RIDOTTO MM
MALE-MALE REDUCED NIPPLE**

CODICE-CODE	MISURA-SIZE
1125014	1/4 - 3/8
1125015	1/8 - 1/4
1125017	3/8 - 1/2
1125044	1/2 - 1/4
1125045	3/8 - 3/4
1125046	1/2 - 3/4
1125047	1" - 1/2
1125048	1/2 - 1"1/4
1125049	3/4 - 1"
1125050	3/4 - 1"1/4
1125051	1" - 1"1/4
1125052	1" - 1"1/2
1125053	1" - 2"
1125054	1"1/4 - 1"1/2



**RIDUZIONE ESAGONALE
HEXAGONAL REDUCTION**

CODICE-CODE	MISURA-SIZE
1125020	3/4 - 3/8
1125043	1" - 1"1/4
1125055	1/8 - 1/4
1125056	1/8 - 3/8
1125057	1/4 - 3/8
1125058	1/4 - 1/2
1125059	3/8 - 1/2
1125060	1/2 - 3/4
1125061	1/2 - 1"
1125062	1/2 - 1"1/4
1125063	1/2 - 1"1/2
1125064	1/2 - 2"
1125065	3/4 - 1"
1125066	3/4 - 1"1/4
1125067	3/4 - 1"1/2
1125068	3/4 - 2"
1125069	1" - 1"1/2
1125070	1" - 2"



**RIDUZIONE ESAGONALE F-M
F-M HEXAGONAL REDUCTION**

CODICE-CODE	MISURA-SIZE
1125108	1/4 - 1/8
1125109	3/8 - 1/4
1125110	3/8 - 1/2
1125112	1/2 - 3/8
1125113	1/2 - 1/2
1125114	3/4 - 1/2
1125126	3/4 - 3/8



**RIDUZIONE ESAGONALE F-F
F-F HEXAGONAL REDUCTION**

CODICE-CODE	MISURA-SIZE
1125097	3/8 - 1/2
1125111	3/8 - 3/8



**GOMITO F-F
ELBOW JUNCTION F-F**

CODICE-CODE	MISURA-SIZE
1125117	1/2 - 1/2
1125118	3/4 - 3/4



**RACCORDO TRE VIE OTTONE TEE F-F-F
T HOLDER JUNCTION F-F-F**

CODICE-CODE	MISURA-SIZE
1125025	3/8 - 3/8 - 3/8
1125119	1/2 - 1/2 - 1/2
1125120	3/4 - 3/4 - 3/4

SERRAFIETTI PER RACCORDERIA



1143021 Serrafieletti omologato come sigillante per gas e acqua potabile, smontabile e resistente ad urti e vibrazioni.

Caratteristiche tecniche:

Diametro: M24

Gioco max : mm 0,20

Temperatura di impiego: -55° + 150°

1143021 Medium strength anaerobic adhesive for thread locking of nuts and bolts of all types that require to be dismantled. Suitable to be used on oily surfaces. Highly resistant to heat, corrosion, vibrations, water, gas, oils, hydrocarbons and many chemicals.

Technical specifications:

Diameter: M24

Temperature range: -55° + 150°

1143014 Loctite 55 è un sottile nastro bianco multifilo, senza trama, di circa 1mm di larghezza per 0.25mm di spessore in grado di sigillare istantaneamente raccordi filettati (fino a 6" di diametro), in plastica e metallo. Sostituisce canapa e nastri in PTFE.

Caratteristiche tecniche:

Sigillatura di componenti filettati, come giunzioni e raccordi per tubi; sigilla fluidi e non fino alla temperatura di 150°C. E' particolarmente adatto in caso di utilizzo immediato dell'impianto e dove vi sia la necessità di un riposizionamento prima dell'uso.

1143014 Loctite 55 is a general purpose threaded pipe and fitting sealant. A non-curing coated multifilament cord that seals out air and other common gases and fluids.

Recommended for sealing metal and plastic tapered pipe fittings up to 4" NPT for use in industrial

applications in aqueous and non-aqueous fluids. Particularly suitable in threaded assembly applications that require immediate use and may undergo small readjustments before use. This product is typically used in applications up to 149 °C.



THREADSEALING-THREADLOCKING



**GHIERA DI RIDUZIONE
REDUCTION METAL RING**

CODICE-CODE	MISURA-SIZE
1125074	3/8 - 1/2
1125075	1/2 - 3/4



**MANICOTTO FF
FEMALE-FEMALE JOINT**

CODICE-CODE	MISURA-SIZE
1125094	1/4
1125095	3/8
1125096	1/2



**TAPPO M
MALE CAP**

CODICE-CODE	MISURA-SIZE
1125098	1/8
1125099	1/4
1125100	3/8
1125101	1/2







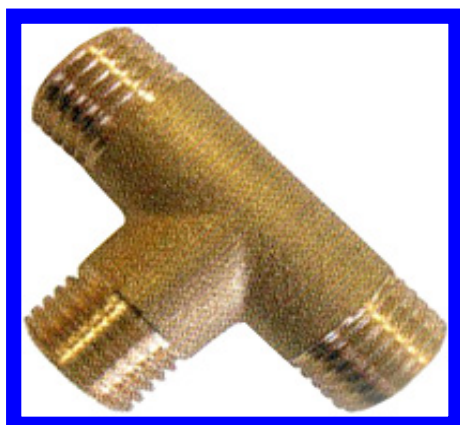





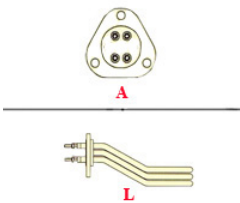

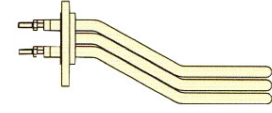
**TAPPO F
FEMALE CAP**

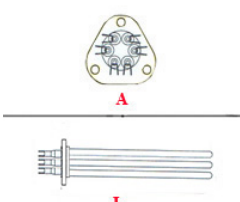

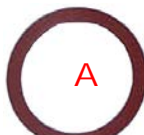
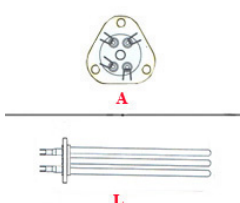

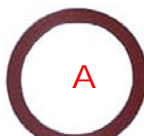
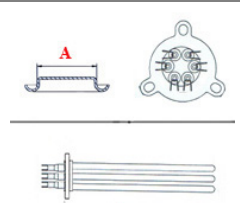



CODICE-CODE	MISURA-SIZE
1125102	1/4
1125103	3/8
1125104	1/2

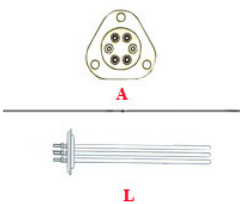

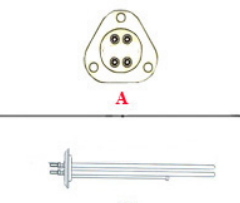

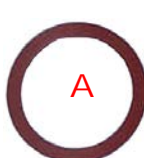
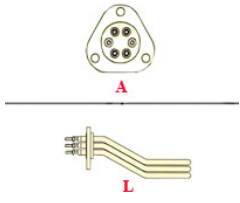

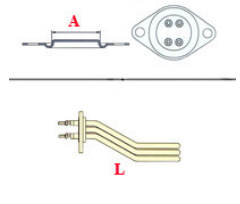



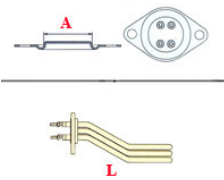

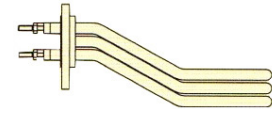

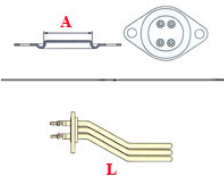
**RACCORDO TRE VIE OTTONE TEE M-M-M
T HOLDER JUNCTION M-M-M**

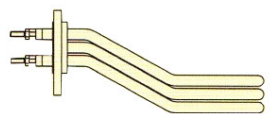

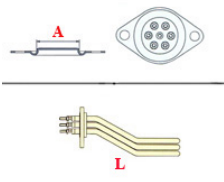

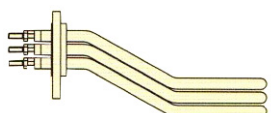





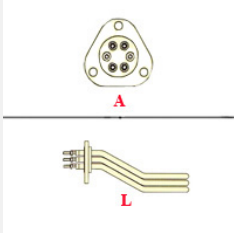

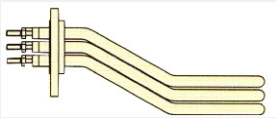
CODICE-CODE	MISURA-SIZE
1125140	1/4 - 1/4 - 1/4
1125141	3/8 - 3/8 - 3/8
1125142	1/2 - 1/2 - 1/2
1125143	3/4 - 3/4 - 3/4

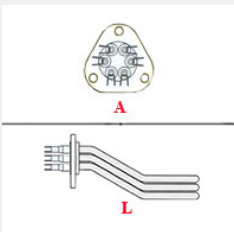

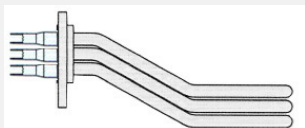

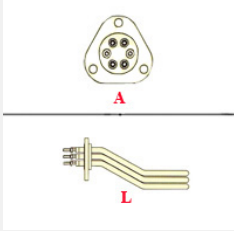

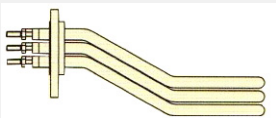





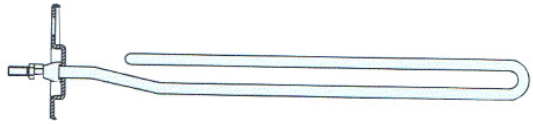

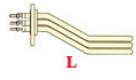

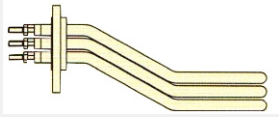
Flangia / Flange Potenza / Watts	Codice / Code	Lunghezza / Length	Guarnizione Gasket
 <p>A=38 mm</p>	<p>VIBIEMME</p> 	 <p>L</p>	
3000 W	1101185	L=340 mm	2107079
4000 W	1101183	L=450 mm	2107079
 <p>A=38 mm</p>		 <p>L</p>	
3990 W	1101322	L=290 mm	2102318
6000 W	1101323	L=365 mm	2102318
 <p>A=38 mm</p>		 <p>L</p>	
2700 W	1101344	L=290 mm	2102318
 <p>A=39mm</p>	<p>LA PAVONI</p> 	 <p>L</p>	
4000 W	1101170	L=300 mm	





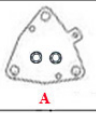





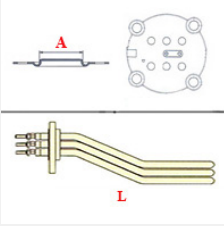

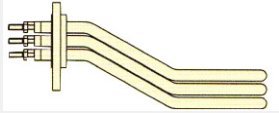
Flangia / Flange Potenza / Watts	Codice / Code	Lunghezza / Length	Guarnizione Gasket
 <p>A=39 mm</p>	<p style="text-align: center;">SACOM</p> 	 <p style="text-align: center;">L</p>	
5000 W	1101859	L=595 mm	
 <p>A=40 mm</p>	<p style="text-align: center;">LA PAVONI</p> 	 <p style="text-align: center;">L</p>	
4000 W	1101904	L= 365 mm	
5500 W	1101905	L= 565 mm	
 <p>A=40 mm</p>	<p style="text-align: center;">LA PAVONI</p> 	 <p style="text-align: center;">L</p>	
3000 W	1101702	L=240 mm	
4000 W	1101703	L=300 mm	
 <p>A=42 mm</p>	<p style="text-align: center;">ASTORIA / FAEMA/ WEGA</p> 	 <p style="text-align: center;">L</p>	
2000 W	1101178	L=170 mm	2102130

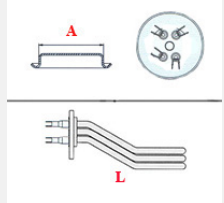
Flangia / Flange Potenza / Watts	Codice / Code	Lunghezza / Length	Guarnizione Gasket
2600 W	1101621	L=280 mm	2102130
2600 W	1101889	L=295mm	2102130
3700 W	1101890	L=495 mm	2102130
 A=42 mm	ASTORIA/ FAEMA/ WEGA 	 L	
2600 W	1101035	L=340 mm	2102130
3700 W	1101186	L=460 mm	2102130
4000 W	1101450		2102130
 A=42 mm	ASTORIA / FAEMA / WEGA 	 L	
1500 W	1101653	L=160 mm	2102130
1800 W	1101037	L=170 mm	2102130
 A=42 mm	ASTORIA / FAEMA / WEGA 	 L	
1800 W	1101448	L=180 mm	2102130
2600 W	1101036	L=340 mm	2102130
3400 W	1101451	L=320 mm	2102130
3600 W	1101070	L=455 mm	2102130
4000 W	1101279	L=300 mm	2102130
4500 W	1101452		2102130

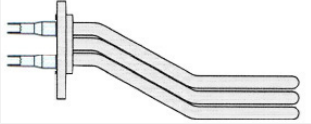
Flangia / Flange Potenza / Watts	Codice / Code	Lunghezza / Length	Guarnizione Gasket
 <p>A=42 mm</p>	<p>MAGISTER</p> 	 <p>L</p>	
<p>1600 W</p>	<p>1101349</p>	<p>L= 190 mm</p>	<p>2102130</p>
 <p>A=42 mm</p>	<p>MAGISTER</p> 	 <p>L</p>	
<p>2700 W</p>	<p>1101297</p>	<p>L= 210 mm</p>	<p>2102130</p>
<p>4500 W</p>	<p>1101378</p>	<p>L= 350 mm</p>	<p>2102130</p>
 <p>A=39 mm</p>	<p>MAGISTER</p> 	 <p>L</p>	
<p>4500 W</p>	<p>1101575</p>	<p>L= 4500 mm</p>	<p>2107079</p>

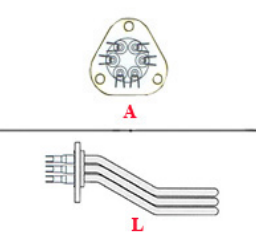
Flangia / Flange Potenza / Watts	Codice / Code	Lunghezza / Length	Guarnizione Gasket
 <p>A=44 mm</p>	<p style="text-align: center;">RANCILIO</p> 	 <p style="text-align: center;">L</p>	
2700 W	1101005	L=390 mm	2102014
3000 W	1101526	L=225 mm	2102014
3900 W	1101004	L=390 mm	2102014
6000 W	1101198	L=440 mm	2102014
 <p>A=44 mm</p>	<p style="text-align: center;">RANCILIO</p> 	 <p style="text-align: center;">L</p>	
3000 W	1101008	L=230 mm	2102014
4300 W	1101181	L=390 mm	2102014
6000 W	1101198	L=440 mm	2102014
 <p>A=46 mm</p>	<p style="text-align: center;">SAN MARCO</p> 	 <p style="text-align: center;">L</p>	

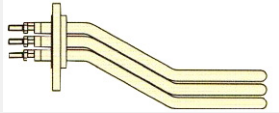
Flangia / Flange Potenza / Watts	Codice / Code	Lunghezza / Length	Guarnizione Gasket
3500 W	1101021	L=380 mm	2102034
4500 W	1101011	L=570 mm	2102034
 	CONTI 		
3500 W	1101841	L=340 mm	
4700 W	1101842	L=555 mm	
  A=54 mm	NUOVA SIMONELLI 	 L	
2700 W	1101652	L=185 mm	2107119
3000 W	1101441	L=300 mm	2107119
  A=59 mm	CIMBALI 	 L	
1800 W	1101168	L=170 mm	2102134
3750 W	1101068	L=430 mm	2102134
5790 W	1101069	L=570 mm	2102134
  A=59 mm	CIMBALI 	 L	

Flangia / Flange Potenza / Watts	Codice / Code	Lunghezza / Length	Guarnizione Gasket
1500 W	1101467	L= 160 mm	2102134
 A=66 mm	CONTI 	 L	
4000 W	1101692	L=400 mm	
5000 W	1101693	L=600 mm	
6000 W	1101694	L=600 mm	
 A=75 mm	BEZZERA 	 L	
4600-5450 W	1101704	L=530 mm	
 A=53 mm	LA SPAZIALE 	 L	
2800 W	1101706	L=356 mm	2107045

1101005 RESISTENZ
A 2700W/220V
RANCILIO /
HEATING ELEMENT
2700W/220V RANCILIO
Z92GR,Z112GR,S102G
R:
RANCILIO SPA
LS38/39:
RANCILIO SPA
3: PROMAC

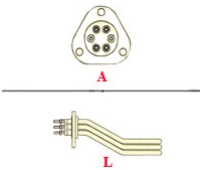

A=44mm, L=390mm,
GASKET= 2102014

1101526 RESISTENZ
A TECNA 3000W L240
VITE /
HEATING ELEMENT
RANCILIO TECNA
3000W/220V SCREWS

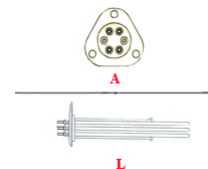

A=44mm, L=225mm,
GASKET= 2102014

1101008 RESISTENZ

A TECNA 3000W L240
FASTON /
HEATING ELEMENT
TECNA 3000W L240
FASTON

33323300:

RANCILIO SPA

S20TECNA,S20

SYSTEM 2GR,Z112GR:

RANCILIO SPA

5: PROMAC

36322027:

RANCILIO SPA

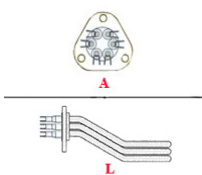

A=44mm, L=230mm,
GASKET= 2102014

1101004 RESISTENZ

A 3900W/230V
RANCILIO /
HEATING ELEMENT
3900W/230V RANCILIO

2: PROMAC

LS60,LS66,LS120:

RANCILIO SPA

Z112GR,S20

SYSTEM2GR,Z93GR,S

103GR,MILLENIUM

2GR: RANCILIO SPA

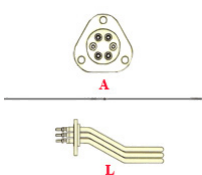

A=44mm, L=390mm,
GASKET= 2102014

1101181 RESISTENZ

A RANCILIO
4300W/230V L400 /
HEATING ELEMENT
RANCILIO 4300W 230V
L400

33323430:

RANCILIO SPA

Z93GR,Z113GR,SYSTE

M3GR,MILLENIUM2G

R,EPOCA,C63GR:

RANCILIO SPA

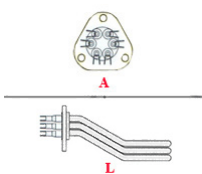

A=44mm, L=390mm,
GASKET= 2102014

1101198 RESISTENZ

A 6000W RANCILIO
L400 /
HEATING ELEMENT
6000W RANCILIO L400

Z94GR,Z114GR:

RANCILIO SPA

C6 3GR,C83GR:

RANCILIO SPA

S103GR,MILLENIUM3

GR,C103/4GR:

RANCILIO SPA

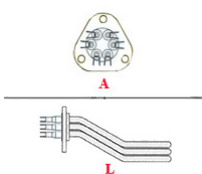

A=44mm, L=400mm,
GASKET= 2102014

1101683 RESIST.BOIL

ER 230V 2400W /
BOILER HEATING
ELEMENT 230V 2400W

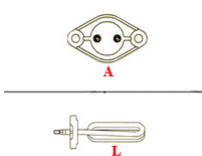

1101653 RESIST. LT.

5 V.230 W1500 /
HEATING ELEMENT
LT.5 V230 W1500

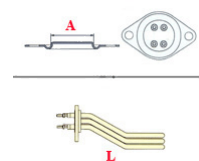

A=42mm, L=160mm,
GASKET= 2102130

1101037 RESISTENZ

A WEGA 1 GR.1800W /
HEATING ELEMENT
WEGA 1 GR 1800W

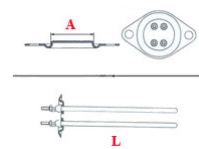

A= 42mm, L = 170mm,
GASKET= 2102130

1101178 RESISTENZ

A ASTORIA 1GR. 2000W

/

HEATING ELEMENT

ASTORIA 1GR. 2000W

17002*:

CMA MACCHINE PER

CAFFE' SRL

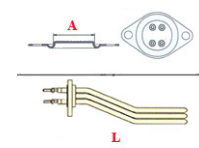

A=42mm, L=170mm,
GASKET= 2102130

1101450 RESISTENZ

A 2GR. 380V 4000W /

HEATING ELEMENT

2GR 380V 4000W

17053:

CMA MACCHINE PER

CAFFE' SRL

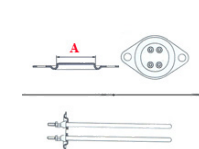

GASKET= 2102130

1101448 RESISTENZ

A 1 GR ASTORIA 6P

230/380V 1800W /

HEATING ELEMENT 1

GR. ATRORIA 6P

230/380V 1800W

17006: CMA

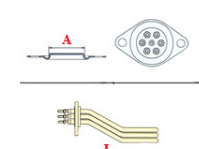

A= 42 mm,L= 180 mm,
GASKET=2102130

1101036 RESISTENZ

A WEGA/ASTORIA 2GR

2600W /

HEATING ELEMENT

WEGA 2 GR 2600W

1: WEGA SRL

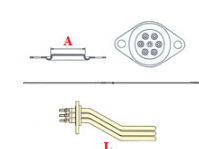

A= 42mm, L= 340mm,
GASKET= 2102130

1101451 RESISTENZ
A 2GR. 6P 3400W
230/380V /
HEATING ELEMENT
2GR 6P 3400W 230/380V
17059:
**CMA MACCHINE PER
CAFFE' SRL**

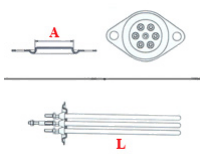

A=42 mm,
GASKET= 2102130

1101070 RESISTENZ
A WEGA 3 GR. 6 POLI
3600W /
HEATING ELEMENT
WEGA 3 GR
1: CMA MACCHINE
PER CAFFE' SRL
2: WEGA SRL

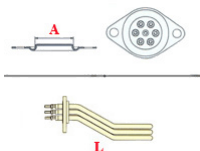

A= 42mm, L= 455mm,
GASKET= 2102130

1101279 RESISTENZ
A WEGA/ASTORIA
4000W 230/400 C/G /
HEATING ELEMENT
WEGA/ASTORIA 4000W
2307400 C/G

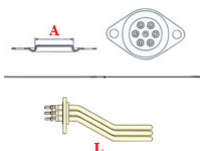

A=42 mm, L=300 mm,
GASKET= 2102130

1101452 RESISTENZ
A 2 GR. 6P 4500W
230/380V /
HEATING ELEMENT
2GR 6P 4500W 230/380V
17060:
**CMA MACCHINE PER
CAFFE' SRL**

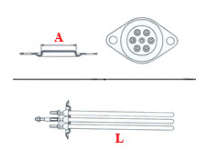

A=42 mm,
GASKET= 2102130

1101621 RESISTENZ
A GR2 W 2600 STAR
V230 /
HEATING ELEMENT
GR2 2300W STAR 230V

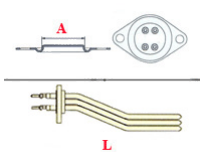

A=42mm, L=280mm,
GASKET= 2102130

1101035 RESISTENZ
A FAEMA 2 GR 2600W /
HEATING ELEMENT
FAEMA 2 GR 2600W
02212439:
FUTURMAT
3541133003: FAEMA

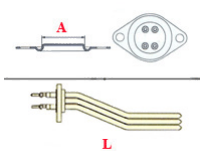

A=42mm, L=340mm,
GASKET= 2102130

1101186 RESISTENZ
A FAEMA 3 GR. 3700W
220V /
HEATING ELEMENT
FAEMA 3 GR. 3700W
220V

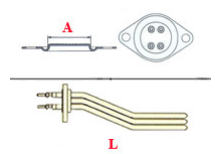

A=42mm, L=460mm,
GASKET= 2102130

1101572 RESISTENZ
A FAEMA E/98 2 GR
W3750 V220/380 /
HEATING ELEMENT
FAEMA E/98 2 GR
W3750 V220/380

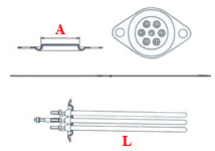

A=42mm, L= 285mm,
GASKET= 2102130

1101349 RESISTENZ
A V 230 W 1600 MGST
1GR /
HEATING ELEMENT
230V 1600W MGST 1GR
**180050: MAGISTER
SISTEMA CAFFE' SRL**

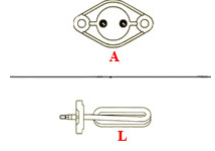

A=42 mm, L=190 mm,
GASKET= 2102130

1101297 RESISTENZ
A 2700W 230/400V 2 GR
/
HEATING ELEMENT
2700W 230/400V
MS/ES, 70/100.2:
**MAGISTER SISTEMA
CAFFE' SRL**

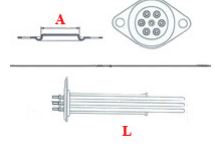

2700 W, A=43 mm,
L= 210 mm,
GASKET= 2102130

1101378 RESISTENZ
A 4500W 230V /
HEATING ELEMENT
4500W 230V
180053:
**MAGISTER SISTEMA
CAFFE' SRL**

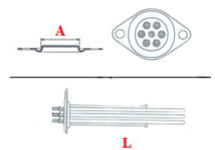

A=43 mm, L=350mm,
GASKET= 2102130

1101575 RESISTENZ
A V 230 W 4500 /
HEATING ELEMENT
230V 4500W
180196:
**MAGISTER SISTEMA
CAFFE' SRL**

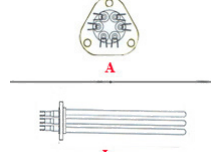

A=39 mm, L=370mm,
GASKET= 2107079

1101170 RESISTENZ

A 4000W 230V 2BAR
(TN) R01 /
HEATING ELEMENT
4000W 230V 2GR
PAVONI

331114:

LA PAVONI SPA

2310004001:

LA PAVONI SPA

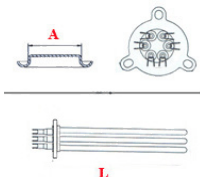

A=39mm, L=300mm

1101011 RESISTENZ

A S.MARCO 3GR 4500W

/ HEATING ELEMENT S.
MARCO 3 GR. 4500W

1: SAN MARCO

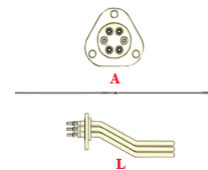

A=46mm, L=570mm,
GASKET= 2102034

1101841 RESISTENZ

A 1 ELEMENTO 3500W
/230 LSF350mm /
HEATING ELEMENT
3500W / 230V
LSF350mm

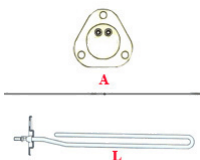

L= 340 mm

1101467 RESISTENZ

A FAEMA 1500W 220V
COMPACT /
HEATING ELEMENT
FAEMA 1500W 220V
COMPACT

442-501-005:

CIMBALI

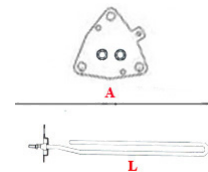

A=59mm, L=160mm,
GASKET= 2102134

1101842 RESISTENZ

A 1 ELEMENTO 4700W
/230 LS560mm /
HEATING ELEMENT 1
ELEMENT 4700W / 230V
LSF560mm

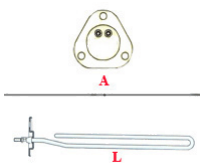

L= 555 mm

1101168 RESISTENZ

A CIMBALI 1 GRUPPO
1800W /
HEATING ELEMENT
CIMBALI 1 GR. 1800W

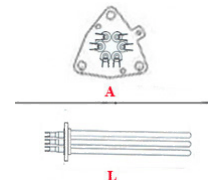

A=59mm, L=170mm,
GASKET=2102134

1101185 RESISTENZ

A VBM 2GR. 3000W
220V / HEATING
ELEMENT VBM 2GR.
3000W 220V

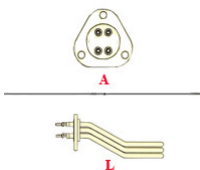

A=39 mm, L=340mm,
GASKET= 2107079

1101068 RESISTENZ

A CIMBALI M20 2GR. /
HEATING ELEMENT
CIMBALI M20 2 GR

3: CIMBALI

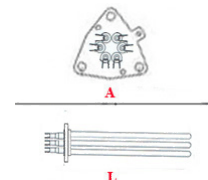

A=59mm, L=430mm,
GASKET= 2102134

1101183 RESISTENZ

A VBM 3GR 4000W
220V / HEATING
ELEMENT VBIEMME
3GR 4000W 220V

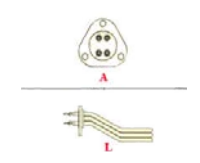

A=39mm, L=450mm,
GASKET= 2107079

1101069 RESISTENZ

A CIMBALI M20 3GR. /
HEATING ELEMENT
CIMBALI M20 3 GR

477512030: CIMBALI

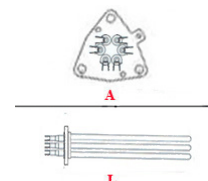

A=59mm, L=570mm,
GASKET= 2102134

1101021 RESISTENZ

A SAN MARCO 2 GR
3500W 3 ELEMENTI /
HEATING ELEMENT
SAN MARCO 2 GR
2600W

183508: SAN MARCO

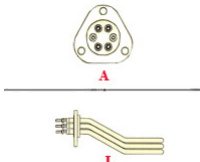

A=46mm, L=380mm,
GASKET= 2102034

1101702 RESISTENZ

A 3 EL .LA PAVONI
W3000 V230/400 L.24
1/2GR /
HEATING ELEMENT 3
EL. LA PAVONI 3000W
230/400V L.24 1/2GR

331120:

LA PAVONI SPA

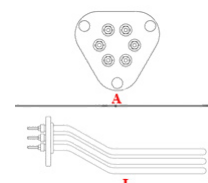

L=240mm, A=40mm

1101703 RESISTENZ

A 3 EL. LA PAVONI
W4000 V230/400 L.30
2GR /
HEATING ELEMENT 3
EL. LA PAVONI 4000W
230/400W L. 30 2GR

331129:

LA PAVONI SPA

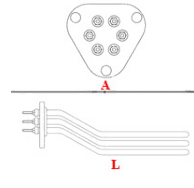

L=300mm, A=40mm

1101652 RESISTENZ

A 2700W 220V
PREMIER /
HEATING ELEMENT
2700W 220V PREMIER

14100027:

NUOVA SIMONELLI
SPA

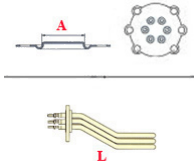

A=54mm, L=185mm,
GASKET= 2107119

1101441 RESISTENZ

A 3000W PR/ 2 GR. /
HEATING ELEMENT 2
GR. 3000W

14100011:

NUOVA SIMONELLI
SPA

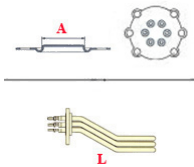

A=54mm, L=300mm,
GASKET= 2107119

1101692 RESISTENZ

A CONTI 3EL -4000W-
230/400V L430mm /
HEATING ELEMENT
CONTI 3 ELEMENTS
4000W 230/400V
L430mm

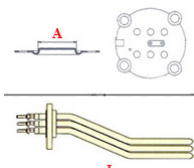

A=66mm, L=400mm

1101693 RESISTENZ

A CONTI 3EL -5000W-
230/400V L600mm /
HEATING ELEMENT
CONTI 3 EL-
5000W.230/400V
L600mm

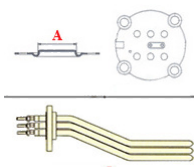

A=66mm, L=600mm

1101694 RESISTENZ

A CONTI 3EL -6000W-
230/400V L660mm /
HEATING ELEMENT
CONTI 3EL-6000W-
230/400V L660mm

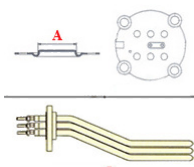

A=66mm, L=600mm

1101704 RESISTENZ

A BEZZERA
4600/5450W 3 GR /
HEATING ELEMENT
BEZZERA 4600/5450W 3
GR

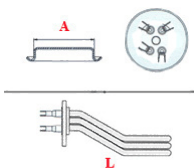

A=75mm, L=530mm

1101706 RESISTENZ

A 2 GR. 220V/2800W
NICHELATA /
HEATING ELEMENT 2
GR. 220V/2800W

05504:

LA SPAZIALE SPA

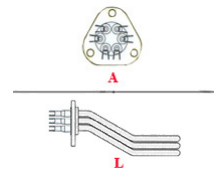

A= 53 mm, L= 356 mm
gasket=2107045

1101440 RESISTENZ

A CALDAIA 1200W
OSCAR 1" /
"HEATING ELEMENT
1" OSCAR"

14100040:

NUOVA SIMONELLI
SPA

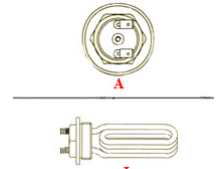

A= 1", L=160mm,
GASKET= 2101569

1101619 RESISTENZ

A 1" BRASILIA
1350W/220V /
"HEATING ELEMET 1"
BRASILIA 1350W/220V"

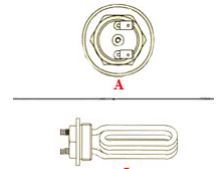

A=1", L=140mm,
GASKET= 2101569

1101117 RESISTENZ

A MATASSA 1"1/4
230/1300W /
"TANK HEATING
ELEMENT 1"1/4
230/1300W"

17201ex: CMA

4617201: CMA

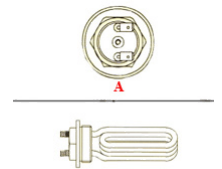

A= 40mm, L= 95mm,
gasket=2107147

1101767 RESISTENZ

A 1500W 230V /
HEATING ELEMENT
1500W 115V

180157:

MAGISTER SISTEMA
CAFFE' SRL

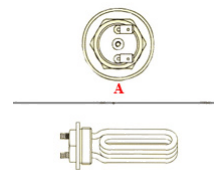

1101699 RESISTENZ

A CALDAIA CECILIA /
HEATING ELEMENT
BOILER CECILIA

V0017:

LA PICCOLA S.A.S.

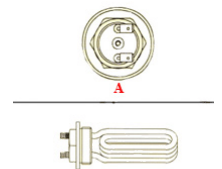

A=42 mm, L=95 mm,
GASKET= 2107147

1101920 RESISTENZ
A 1" 1/4 230V 2600W /
HEATING ELEMENT 1"
1/4 230V 2600W
**14100088: NUOVA
SIMONELLI SPA
1755111: L**

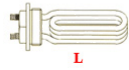
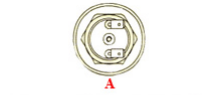

L=155mm,
GASKET=2107147,
A=42mm

1101609 RESISTENZ
A 1" 1000W 230V /
"HEATING ELEMENT
1" 1000W 230V"

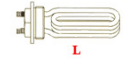
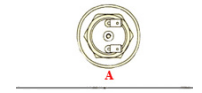

A= 1", L= 170mm,
GASKET= 2101475

1101713 RESISTENZ
A 2500 W 230 V 1" /
HEATING ELEMENT
2500 W 230 V 1"

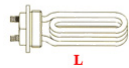
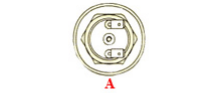

1101770 RESISTENZ
A 1800 W 230 V 1" 1/4 /
HEATING ELEMENT
1800 W 230 V 1" 1/4

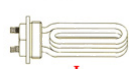

A=1" 1/4

1101209 RESISTENZ
A 2400W 220V
VIBIEMME 1" 1/4 /
HEATING ELEMENT
1500W 220V VIBIEMME

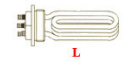

A=40 mm ,L=250 mm,
GASKET=2107147

1101427 RESISTENZ
A CALDAIA GRIMAC
TWENTY 3300W /
BOILER HEATING
ELEMENT GRIMAC
TWENTY 3300W

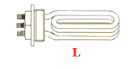
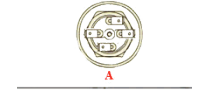

A=40mm ,L=210mm,
Gasket=2107147

1101711 RESISTENZ
A ROBOCAF W1000
V230 M10X1 /
HEATING ELEMENT
ROBOCAF W1000 V230
M10X1
**1043220008 :
BRASILIA SPA**

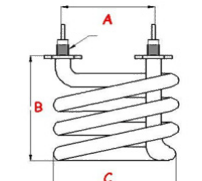

Ø= 8mm, A=35mm,

1101241 RESISTENZ
A FAMILY 1000W/230V
/
HEATING ELEMENT
FAMILY 1150W 230V
**BETSY, FANTASY:
RANCILIO SPA**

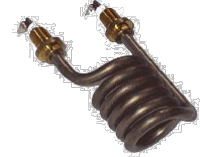

B= 55mm, C=80mm,
gasket=2102041,
gasket=2102090

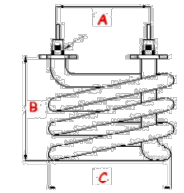

A= 40mm, B=62mm,
C=52mm, Ø=10mm,
GASKET=2101378

1101052 RESISTENZ
A MISS 230V 1100W /
HEATING ELEMENT
MISS 230V
**AUDREY, NANCY, LUCY
, KATHY, SYLVIA:
RANCILIO SPA**

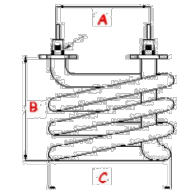

B= 68mm, C= 52mm,
Ø= 14mm

1101797 RESISTENZ
A MACCHINA
FAMIGLIA 1000W 230V
/
FAMILY HEATING
ELEMENT MACHINE
1000W 230V

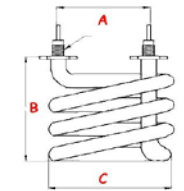

A=43mm, B=63mm,
C=53mm, Ø=10mm

1101848 RESISTENZ
A 5 LT. 2700 W 230 V /
HEATING ELEMENT
5LT 2700W-230V
**00425T:
LA SPAZIALE SPA**

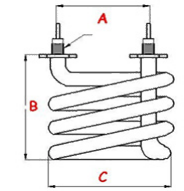

A=50mm, B=200mm,
C=111mm,
GASKET=2102606

1101266 RESISTENZ
A MACCHINA CAFFE' /
HEATING ELEMENT
LA SPAZIALE
**00806:
LA SPAZIALE SPA**



1101344 RESISTENZ
A 2700W 230V DUE
ELEMENTI /
HEATING ELEMENT
2700W 230V
**984076000:
GRUPPO CIMBALI SPA
9041129EX:
GRUPPO CIMBALI SPA**

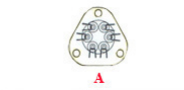

A=38mm, L=290mm,
GASKET= 2102318

1101322 RESISTENZ

A 230 W3990 TER
ELEM. /
HEATING ELEMENT
230 3990W

984142000:

GRUPPO CIMBALI SPA

9140217EX:

GRUPPO CIMBALI SPA

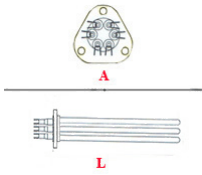

A=38 mm, L=290 mm,
GASKET= 2102318

1101323 RESISTENZ

A 230V/6000W /
HEATING ELEMENT
230V/6000W

984169000:

GRUPPO CIMBALI SPA

9141303:

GRUPPO CIMBALI SPA

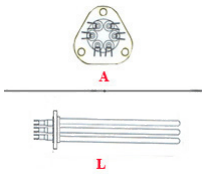

A=38 mm, L=365 mm,
GASKET= 2102318

1101808 RESISTENZ

A BOILER /
HEATING ELEMENT
BOILER

20069: ADLER S.P.A.

070307:

ELECTROLUX.

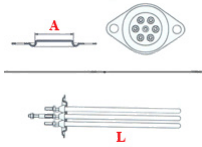

1103843 VENTOLA

ASPIRAZIONE 24V /
FAN SUCTION 24V

998057000:

CASADIO HBS SRL A

SOCIO UNICO



DIMENSIONS
40X40X20mm

1114419 VENTOLAR

AFFREDAMENTODISP

LAY /

FAN DISPLAY

CLASSE 10:

RANCILIO SPA



1103825 POMPA A

VIBRAZIONE NME4RF

230/240V-50HZ 16W /

PUMP VIBRATION

NME4RF 230 / 240V-

50HZ 16W



1103746 POMPA

ULKA EP8 230V /

PUMP ULKA EP8 230V

P1: LA PICCOLA S.A.S.



1103535 POMPETTA

A VIBRAZIONE

MODELLO HF 22W

230V /

PUMP HF 22W 230V



1103016 POMPA

ULKA 230 EP5 /

PUMP ULKA 230 EP5

1103016: GAGGIA



X=1103236, Y=1125032,
W=3118014, Z=4116191,
48 WATT, 230V

1103167 POMPA

ULKA EP5 110V /

PUMP ULKA EP5 110V

AUDREY, NANCY,

BETSY, SILVIA, L4,

S24: RANCILIO SPA



X=1103236, Y=1125032,
W=3118014, Z=4116191,
48W, 110V

1103232 POMPA

ULKA EP5 24V /

PUMP ULKA EP5 24V



X=1103236, Y=1125032,
W=3118014, Z=4116191,
48W, 24V

1103774 POMPA

VIBRAZIONE 48W 230V

CNTT-OTN /

VIBRATION PUMP 48W

230V



1103861 POMPA A

VIBRAZIONE 64W

EAX5 220V 60HZ /

PUMP VIBRATION

EAX5 64W 220V 60HZ



1103236 RACCORDO
BY-PASS POMPA
VIBRAZIONE /
VIBRATION PUMP BY-
PASS CONNECTION



1103906 POMPA A
VIBRAZIONE
DETERGENTE 70W
220/240V 60Hz /
DETERGENT
VIBRATORY PUMP
70W 220/240V 60Hz



1103109 POMPA A
VIBRAZ.FLUID O TECH
70W /
VIBRATION PUMP
FLUID O TECH 70W
UNIVERSAL:
UNIVERSALE



1103759 "POMPA;
230-240V 50-60HZ; UL" /
PUMP, 230-240V 50-
60HZ, UL"

0C9067:
ELECTROLUX
PROFESSIONAL
S.P.A.
0C8347EX:
ELECTROLUX
PROFESSIONAL
S.P.A.
0CA120:
ELECTROLUX
PROFESSIONAL
S.P.A.



1123060 POMPA
DETERGENTE /
DETERGENT DOSING
PUMP
R65110600:
LAINOX ALI SPA



1103024 MOTORE X
VM A FLANGIA /
FLANGE MOTOR FOR
VOLUMETER PUMP
UNIVERSAL:
UNIVERSALE



PUMP=1133019,
PUMP=1133007

1103094 MINIMOTOR
E PER POMPA
FASCETTA /
PUMP MINIMOTOR
1103094: FAEMA



1103103 MOTORE
POMPA CON STAFFA /
MOTOR PUMP WITH
STIRRUP
UNIVERSAL:
UNIVERSALE



1103104 MOTORE
POMPA CON GOMMINI
/
MOTOR PUMP WITH
RUBBER
UNIVERSAL:
UNIVERSALE



1103488 MOTORE
PER VM A FASCETTA /
PUMP MOTOR FOR VM
WITH BAND
1103488:
UNIVERSALE



1103263 MOTORE
RPM NI 230V 50/60
R.H2O ASSIEME /
MOTOR RPM NI 23V
50/60 R.H2O
56406:
CMA MACCHINE PER
CAFFE' SRL



1103599 MOTORE
VM 230-50/60 HZ. /
MOTOR VM 230-50/60
HZ.
34011102:
RANCILIO SPA
34011006:
RANCILIO SPA



1103105 POMPA
COMPLETA A
FASCETTA /
COMPLETE PUMP
WITH BAND
S20 : TECNA, MIDI,
SYSTEM, S26, S26,
L6,L7,EPOCA:
RANCILIO SPA



1103435 MOTORE
ALTEZZA EROGATORE
CON SPINA /
MOTOR



1103490 MOTORE /
MOTOR
*: CEADO SRL
PR30107: FABA SRL



1103493 PACCO
AVVOLTO 220-240V
50Hz /
MOTOR 220-240V 50HZ
SMISPAE01QQQ:
MAZZER LUIGI SPA



1103842 VENTOLINA
PER
MOTOFRULLATORE
CASADIO /
Fan MOTOR-BLENDER
CASADIO
99805300:
CASADIO HBS SRL A
SOCIO UNICO



1134034 MOTORIDU
TTORE MR330 BC H 30
8,5 SAECO /
MOTO REDUCER
MR330 BC H 30 8,5
SAECO

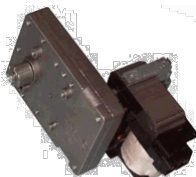

1134052 MOTORIDU
TTORE MR 330 BC H30
8,5RPM 230V /
MOTO REDUCER MR
330 BC H30 8,5RPM
230V



1134104 MOTORIDU
TTORE
CIOCCOLATIERA 230V
50HZ /
GEAR MOTOR FOR
CHOCOLATE
MACHINE 230V 50HZ
2209200012:
UGOLINI SPA



STAFFA= 4119068

1134110 MOTORIDU
TTORE 3-5 LT 230V
50HZ /
GEAR MOTOR 3-5 LT
230V 50HZ
2250002400:
UGOLINI SPA



1134055 MOTORIDU
TTORE PER SPIRALI
MR130 /
MOTO REDUCER
MR130



1134079 MOTORIDU
T. GR MASTER 230V
50HZ / MOTOREDCER
GR MASTER 230V 50HZ
04600001:
NUOVA SIMONELLI
SPA



1134117 MOTORIDU
TTORE 255/268 LOGIX
CON CAVI /
GEAR MOTOR 255/268
LOGIX WITH CABLE



1133024 POMPANTE
COMPACT 100/LT
ATT.FMN /
PUMPING ELEMENT
COMPACT 100/LT



1133025 POMPANTE
COMPACT 100L/H
FASCETTA A-MSCH /
PUMPING ELEMENT
COMPACT 100L/H



1133012 POMPANTE
BILANCIATO 150 LT/H
FASCETTA /
BALANCED PUMPING
ELEMENT WITH BAND
150 LT/H

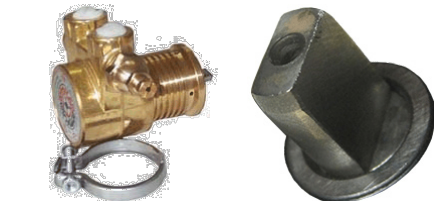

1133004 POMPANTE
PROCON BILANCIATO
A FASCETTA 160/200 l/h
/
BALANCED PROCON
PUMPING ELEMENT
WITH BAND 16/200 l/h
69000002:
RANCILIO SPA
26302:
CMA MACCHINE PER
CAFFE' SRL



1133016 POMPANTE
A FASCETTA 200/LTH /
PUMPING ELEMENT
WITH BAND 200/LTH

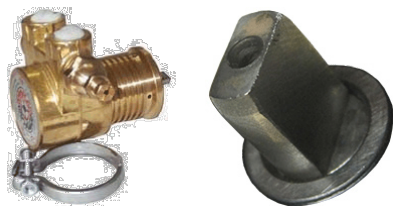

1133011 POMPANTE
BILANCIATO FASC. 200
LT/H ALB.ZIGRINATO /
BALANCED PUMPING
ELEMENT WITH BAND
200 LT/H

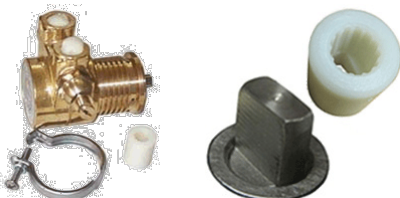

1133026 POMPANTE
A FASCETTA SENZA
PRESA DI PRESSIONE /
PUMPING ELEMENT
FOR COFFEE MACHINE
10705960:
RANCILIO SPA



1133027 "POMPANTE
VOLUMETRICO VM
200L/H ""RANCILIO"" /
RANCILIO
VOLUMETRIC
PUMPING ELEMENT
VM 200L/H



1133007 POMPANTE
PROCON A FLANGIA
BILANCIATO /
BALANCED PROCON
PUMPING ELEMENT
WITH FLANGE
69000001:
RANCILIO SPA

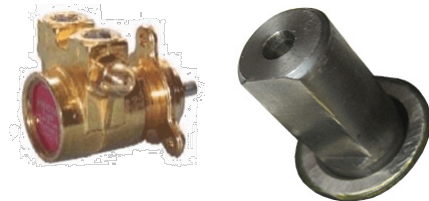

1133018 POMPANTE
PROCON X FAEMA
180/LT3F /
PROCON PUMPING
ELEMENT FOR FAEMA
180/LT 3F

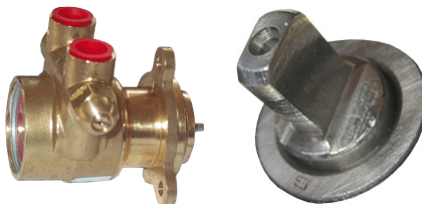

1133019 POMPANTE
A FLANGIA FLUID-O-
TECH 200 LT/H /
FLANGE BALANCED
PUMPING ELEMENT
FLUID-O-TECH 200
LT/H



1133003 POMPANTE
FAEMA 150 LT/H
FLANGIA 2 FORI /
PUMPING ELEMENT
FAEMA 150 LT/H WITH
FLANGE 2 HOLES





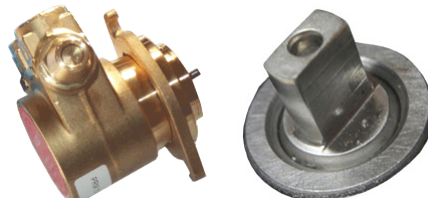



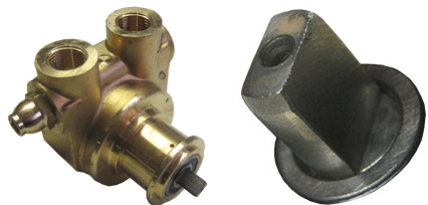



1133020 POMPANTE
FAEMA 2 FORI
C/ALBERO PICCOLO
150L/H /
PUMPING ELEMENT
FAEMA 150 LT/H 2
HOLES



1133023 POMPANTE
FLUID O TECH 1000L/H
/
PUMPING ELEMENT
FLUID O TECH 1000L/H



CODICE S&P S&P CODE		CAPACITA' ELETTRICA μ F CAPACITANCE μ F	ADATTABILITA' ADAPTABILITY
1135008		4 μ F	
1135007		5 μ F	206010: ELETTOBAR DIVISIONE DELLA EUROTEC SRL 631208: COMENDA ALI SPA 00300105: LAMBER DI AFFABA FRANCESCO & C. 3113034: WINTERHALTER ITALIA SRL
1135003		6,3 μ F	631216: COMENDA ALI SPA 0300110: LAMBER DI AFFABA FRANCESCO & C.
1135004		8 μ F	631201: COMENDA ALI SPA 32Z2490: ANGELO PO
1135001		10 μ F	180018: MAGISTER SISTEMA CAFFE' SRL 34020003: RANCILIO SPA 0300106: LAMBER DI AFFABA FRANCESCO & C. R65190180: LAINOX ALI SPA 531401600: CIMBALI
1135002		12,5 μ F	34020004: RANCILIO SPA CECN12: I.M.E. SRL 621207: COMENDA ALI SPA DW1581: DIHR-ALI SPA 047883: ZANUSSI 047541: ZANUSSI
1135006		16 μ F	3400016: RANCILIO SPA 206004: ELETTOBAR DIVISIONE DELLA EUROTEC SRL
1135005		18 μ F	
1135012		20 μ F	206005: ELETTOBAR DIVISIONE DELLA EUROTEC SRL
1135010		25 μ F	

1143004 KIT ANALISI
DUREZZA ACQUA 0-
150MG/L /
WATER HARDNESS
TEST KIT



1143006 SIGILLANTE
RACCORDI PTFE 100ml
/
TEFLON PTFE
SEALING PASTE 100ml



1143020 ADESIVO
ISTANTANEO
MULTIUSO (f120gr) /
MULTIUSE
INSTANTANEOUS
ADHESIVE (f120gr)



1143021 LIQUIDO
SERRAFIILETTI -
55°/+150° (tb50ml) /
TERMINAL-THREAD
LIQUID -55°/+150°
(tb50ml)



1143019 TUBO
GUARNIZIONE
LIQUIDA -55°/+200°
(75ml) /
LIQUID GASKET PIPE -
55°/+150° (75ml)



1143013 BARATTOL
O LOCTITE 55 /
LOCTITE POT 55



1143056 NASTRO
P.T.F.E. SPESSORE
12MT X 12mmX0,1 mm /
RIBBON P.T.F.E. 12MT
X 12mm x THICKNESS
0.1mm



1143007 GRASSO
150GR ALTA
TEMPERATURA /
HIGH TEMPERATURE
OILY 150GR



1143062 GRASSO AL
SILICONE PTFE NSF
100G /
SILICONE OILY PTFE
NSF 100G



1143031 GRASSO
PER RIDUTTORE /
GREASE GEAR BOX

06029401:
SCOTSMAN ICE SRL
06029404:
SCOTSMAN ICE SRL
CMCF06029401:
CASTEL MAC SPA
CMCF06029404:
CASTEL MAC SPA



1143048 GREASE /
GREASE

CMCF26361200:
CASTEL MAC SPA
26361200:
SCOTSMAN ICE SRL



1143010 SILICONE
ROSSO T-65+260° 280ml

/
RED SILICONE TUBE T-
65+260° 280ml

OE2186:
**ELECTROLUX
PROFESSIONAL
S.P.A.**



1143047 TUBETTO
SILICONE PER
PIASTRE VETRO
CERAMICA /
SILICONE TUBE FOR
GLASS CERAMIC
PLATES

PR13048: **FABA SRL**



1143025 PULITORE
LUCIDANTE ACCIAIO
800ml -INOX CLEANER

/
STAINLESS STEEL
POLISHING CLEANER
800ML



1143009 SPRAY AIR
98 400ml /
SPRAY AIR 98 400ml



1143042 SPRAY
RILEVATORE FUGHE
DI GAS /
GASDETEKTOR SPRAY



1143029 BARATTOL
O CC250 C/TAPPO /
POT CC250 WITH
STOPPER



1143014 CONFEZION
E S&P DT-CF GR 900 /
PACKING S&P DT-CF
GR 900



1143016 BARATTOL
O S&P CF-PT 60
PASTIGLIE 2,5 gr /
POT S&P CF-PT 60
TABLETS



1143022 SCATOLA 15
BUSTINE DT-EXPRESS
/
15 PACKET BOX DT-
EXPRESS



1143027 BARATTOL
O DT-CF PASTIGLIA 1gr
/100PZ /
POT S&P DT-CF
TABLETS
1gr/1000PIECES



1143017 CONFEZION
E S&P DS-CRT GR 1000
/
CALCIUM REMOVER
PACKING S&P DS-CRT
GR 1000



1143045 DISINCROST
ANTE ANTICALCARE
ALL'ACETO 500ML /
VINEGAR ANTI-
LIMESTONE SCALE-
REMOVER 500ML



1143018 CONFEZION
E S&P DT-ICE LT1 /
PACKING S&P DT-ICE
LT1



1143057 NEW
CLEANER-1 LT -
SCOTSMAN /
NEW CLEANER-1 LT -
SCOTSMAN
00100905:
SCOTSMAN ICE SRL



1143032 ESPRESSO
MACHINE CLEANER
900GR /
ESPRESSO MACHINE
CLEANER



1143033 GRINDER
CLEANER 430GR /
GRINDER CLEANER
430GR



1143015 CONFEZION
E S&P DT-MLK LT1 /
PACKING S&P DT-MLK
LT1



1143038 MILK
FROTHER CLEANER /
MILK FROTHER
CLEANER



1143054 MINI
CLEANING KT ICE
MAKERS /
MINI CLEANING KT
ICE MAKERS
VAS92921:
BRICE ITALIA SRL



1143055 KIT
PULIZIA/SANITIZZAZI
ONE ICEMAKERS /
CLEANING KIT /
SANITIZATION
ICEMAKERS
KITSANITY:
BREMA ICE MAKERS
SPA



1143058 SANITIZER
(anti alga) /
SANITIZER
26400002:
SCOTSMAN ICE SRL



1143059 SCALEKLEEN
N CONFEZIONE 1 KG /
SCALEKLEEN
PACKAGE 1 KG



1143023 FUSTINO
ASCOR BAR
LAVASTOVIGLIE 10LT-
12KG /
CAN ASCOR BAR DISH-
WASHERS 10LT



1143044 FUSTINO
LT10 DETERSIVO
LAVASTOVIGLIE /
CAN 10LT DETERGENT
FOR DISH-WASHER



1143024 FUSTINO 5
LT BRILLANTANTE /
CAN 5LT ASCOR AD



1143028 SACCO KG
25 DT-CF /
SACK 25KG DT-CF



1143040 ACTIVATED
SCALE REMOVER 28 G
/
ACTIVATED SCALE
REMOVER 28 G







1143041 SCALE
KLEEN SCALE
REMOVER /
SCALE KLEEN SCALE
REMOVER







1143052 SANITISING
BAG /
SANITISING BAG
65090900:
SCOTSMAN ICE SRL







CODICE S&P S&P CODE	DESCRIZIONE DESCRIPTION		CARATTERISTICHE TECNICHE TECHNICAL SPECIFICATIONS
1111001	<p>Doccetta a rete Rancilio Net Shower Rancilio</p>		<p>Saldata con Anellino/Welded with Ring: INOX Bordo/Border: Ø 57 mm Altezza/Height 3,7 mm Foro Centrale/Central Hole: M5</p>
1111031	<p>Doccetta a rete Rancilio Economica Net Shower Rancilio Ec.</p>		<p>Saldata/Welded Bordo/ Border: Ø 57 mm Altezza/Height 3,7 mm Foro Centrale/ Central Shape: M5 Foratura/Puncture: Circolare /Circular Ø Fori/Ø Holes: 1,7 mm</p>
1111002	<p>Doccetta Faema E61 Shower Faema E61</p>		<p>Saldata con bottone centrale / Welded with central button Bordo/Border: Ø 60 mm Altezza/Height 15,7 mm Interno/ Internal</p>

CODICE S&P S&P CODE	DESCRIZIONE DESCRIPTION		CARATTERISTICHE TECNICHE TECHNICAL SPECIFICATIONS
1111030	<p>Doccetta Faema E61 Economica</p> <p>Shower Faema E61 Ec.</p>		<p>Cianfrinata / Caulked Bordo/ Border: Ø 60 mm Altezza/Height: 17 mm Foratura/Puncture: Circolare/Circular Ø Fori/ Holes: 2,5 mm</p>
1111023	<p>Doccetta Faema ad asole</p> <p>Shower Faema with rays</p>		<p>Cianfrinata / Caulked Bordo/ Border: Ø 60 mm Altezza/Height H: 17 mm Foratura/ Puncture: Asole / Rays</p>
1111022	<p>Doccetta Faema cianfrinata or.</p> <p>Shower Faema caulked or.</p>		<p>Cianfrinata/ Caulked Bordo/ Border: Ø 60 mm Altezza/Height 17 mm Foratura/ Puncture: : Circolare / Circular Ø Fori/ Holes: 2,5 mm</p>



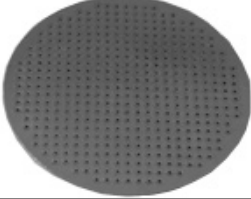



CODICE S&P S&P CODE	DESCRIZIONE DESCRIPTION		CARATTERISTICHE TECNICHE TECHNICAL SPECIFICATIONS
1111003	<p>Doccetta Cimbali ad asole</p> <p>Shower Cimbali with rays</p>		<p>Cianfrinata / Caulked Ø 51,5 mm Foro Centrale Imbutito / Deep-Drawn Central Shape: M5 Foratura/ Puncture: Asole / Rays</p>
1111025	<p>Doccetta Cimbali cianfrinata foro circolare</p> <p>Shower Cimbali caulked shaped central hole</p>		<p>Cianfrinata / Caulked Ø 51,5 mm Foro Centrale Imbutito / Deep-Drawn Central Shape: M5 Foratura Circolare / Circular Puncture Ø Fori/ Holes: 2,5 mm</p>
1111006	<p>Doccetta San Marco</p> <p>Shower San Marco</p>		<p>Cianfrinata/ Caulked Ø 51,5 mm Foro Centrale Imbutito / Deep-Drawn Central Shape: M5 Foratura Circolare / Circular Puncture Ø Fori/ Holes: 2,5 mm</p>





CODICE S&P S&P CODE	DESCRIZIONE DESCRIPTION		CARATTERISTICHE TECNICHE TECHNICAL SPECIFICATIONS
1111004	<p>Doccetta doppia Spaziale</p> <p>Double shower for Spaziale</p>		<p>Ø 51,7 mm Sagomato/Shaped Foro Centrale/ Central Hole: 10 mm Passo Foratura/ Distance Between Holes: 1,5 mm Micro</p> <p>Ø 51,5 mm Foro Centrale/Central Hole: 5 mm Passo Foratura/ Distance Between Holes: 2 mm Normale /Normal</p>
1111027	<p>Doccetta Gaggia</p> <p>Shower Gaggia</p>		<p>Cianfrinata/ Caulked Ø 55 mm Foro Centrale Imbutito/ Deep-Drawn Central Shape: M5 Foratura/Puncture: Tradizionale / Traditional</p>
1111028	<p>Doccetta Gaggia foro circolare</p> <p>Shower Gaggia shaped central hole</p>		<p>Cianfrinata/ Caulked Ø 55 mm Foro Centrale Imbutito/ Deep-Drawn Central Shape: M5 Foratura/Puncture: Circolare / Circular Ø Fori/Holes 2,5mm</p>

CODICE S&P S&P CODE	DESCRIZIONE DESCRIPTION		CARATTERISTICHE TECNICHE TECHNICAL SPECIFICATIONS
1111020	<p>Doccetta C.M.A. originale</p> <p>Shower C.M.A. or.</p>		<p>Cianfrinata/ Caulked Ø 51,5 mm Foro Centrale Imbutito/ Deep-Drawn Central Shape: M5 Foratura/Puncture: Circolare / Circular Ø Fori/ Holes: 2 mm</p>
1111021	<p>Doccetta C.M.A. saldata</p> <p>Shower C.M.A. welded</p>		<p>Saldata con Anellino/ Welded with Ring: INOX Ø 51,5 mm Foro Centrale Imbutito/ Deep-Drawn Central Shape: M5</p>
1111011	<p>Doccetta Brasilia</p> <p>Shower Brasilia</p>		<p>Ø 51,9 mm Passo Foratura / Distance Between Holes: 2 mm Normale /Normal Foro Centrale Imbutito/ Deep-Drawn Central Shape: M5</p>
1111009	<p>Doccia erogazione gruppo leva</p> <p>Counter Filter for Leva Group</p>		<p>Doccia Erogazione Graffe per Gruppo Leva Counter Filter for Leva Group Ø 57 mm Passo Foratura/ Distance Between Holes: 2 mm Normale/ Normal</p>







CODICE S&P S&P CODE	DESCRIZIONE DESCRIPTION		CARATTERISTICHE TECNICHE TECHNICAL SPECIFICATIONS
1111005	Doccetta a disco gr.lewa S.Marco Lever group disk shower S.Marco		<p>Ø 50,5 mm Passo Foratura/ Distance Between Holes: 2 mm Normale/ Normal</p>
1111029	Doccetta Bianchi Shower Bianchi		<p>Ø 32 mm Bombata/Shaped Foro Centrale Imbutito/ Deep-Drawn Central Shape: M4 Passo Foratura/ Distance Between Holes: 1,73mm Esagonale /Exagonal</p>
1111017	Doccetta Nuova Simonelli Shower Nuova Simonelli		<p>Saldato con Anellino/ Welded with Ring: INOX Bordo/ Border: Ø 57 mm Altezza/Height: 3,9 mm Foro Centrale Imbutito/ Deep-Drawn Central Shape: M5</p>
1111012	Doccetta Gaggia 2° tipo Shower Gaggia 2nd type		<p>Cianfrinata/ Caulked Ø 55 mm Foro Centrale Imbutito/ Deep-Drawn Central Shape: M5 Foratura/Puncture: Tradizionale / Traditional</p>
1111035	Doccia a graffe 0 30 Shower 0 30		





FILTRI 1 DOSE / FILTERS 1 DOSE

CODICE S&P S&P CODE	DESCRIZIONE DESCRIPTION	ADATTABILITA' ADAPTABILITY		CARATTERISTICHE TECNICHE TECHNICAL SPECIFICATIONS
3126001	Filtro 1 dose 6 gr Filter 1 dose 6 gr	RANCILIO FAEMA NUOVA SIMONELLI		Bordo/Border: Ø 70 mm Altezza/Height: 20 mm Canalino/ Groove: Esterno /External Passo Foratura/ Distance Between Holes: 1,5 mm Micro
3126006	Filtro 1 dose 7 gr Filter 1 dose 7 gr	RANCILIO FAEMA		Bordo/Border: Ø 70 mm Altezza/Height: 24,5 mm Canalino / Groove: Esterno/ External Passo Foratura / Distance Between Holes: 1,73 mm Esagonale / Exagonal
3126167	Filtro 1 dose 6 gr economico Filter 1 dose 6 gr ec.	RANCILIO FAEMA		Bordo/Border: Ø 70 mm Altezza/Height: 20 mm Canalino/ Groove: Esterno /External Passo Foratura/ Distance Between Holes: 1,5 mm Micro
3126258	Filtro 1 dose 7 gr economico Filter 1 dose 7 gr ec.	RANCILIO FAEMA		Bordo/Border: Ø 70 mm Altezza/Height: 24,5 mm Canalino / Groove: Esterno/ External Passo Foratura / Distance Between Holes: 1,73 mm Esagonale / Exagonal
3126013	Filtro 1 dose Filter 1 dose	CIMBALI		Bordo/ Border: Ø 68 mm Altezza/Height: 22 mm Canalino/ Groove: Interno C /Internal C Passo Foratura/ Distance Between Holes: 1,73 mm Esagonale/ Exagonal
3126247	Filtro 1 dose basso Filter 1 dose short	CIMBALI		Bordo/ Border: Ø 68 mm Altezza/Height: 21 mm Canalino/ Groove: Interno C /Internal C Passo Foratura/ Distance Between Holes: 1,73 mm Esagonale/ Exagonal
3126011	Filtro 1 dose 9 gr Filter 1 dose 9 gr	SAN MARCO		Bordo/ Border: Ø 66 mm Altezza/Height: 25,5 mm Canalino/ Groove: Esterno/External Passo Foratura/ Distance Between Holes: 1,5 mm Micro

CODICE S&P S&P CODE	DESCRIZIONE DESCRIPTION	ADATTABILITA' ADAPTABILITY		CARATTERISTICHE TECNICHE TECHNICAL SPECIFICATIONS
3126169	Filtro 1 dose 9 gr Filter 1 dose 9 gr	SAN MARCO		Bordo/ Border: Ø 66 mm Altezza/Height: 25 mm Canalino/ Groove: Esterno/External 57 mm Passo Foratura/ Distance Between Holes: 1,5 mm Micro
3126045	Filtro 1 dose 7gr Filter 1 dose 7 gr	SPAZIALE		Bordo/ Border: Ø 65 mm Altezza/Height: 25 mm Canalino/ Groove: Esterno/ External Passo Foratura/ Distance Between Holes: Esagonale/Exagonal 1,73 mm
3126018	Filtro 1 dose 7 gr Filter 1 dose 7 gr	GAGGIA CARIMALI		Bordo/ Border: Ø 68 mm Altezza / Height: 24,5 mm Canalino/ Groove: Esterno/ External Passo Foratura/ Distance Between Holes: Esagonale/Exagonal 1,73 mm
3126246	Filtro 1 dose 7 gr Filter 1 dose 7 gr	C.M.A. FAEMA		Bordo/ Border: Ø 70 mm Altezza/Height: 24,5 mm Canalino/ Groove: Esterno/ External Passo Foratura/ Distance Between Holes: 1,5 mm Micro

FILTRI 2 DOSE / FILTERS 2 DOSES

CODICE S&P S&P CODE	DESCRIZIONE DESCRIPTION	ADATTABILITA' ADAPTABILITY		CARATTERISTICHE TECNICHE TECHNICAL SPECIFICATIONS
3126002	Filtro 2 dosi 12 gr Filter 2 doses 12 gr	RANCILIO FAEMA NUOVA SIMONELLI		Bordo/Border: Ø 70 mm Altezza/Height: 22 mm Canalino/ Groove: Esterno /External Passo Foratura/ Distance Between Holes: 1,5 mm Micro
3126007	Filtro 2 dosi 14 gr Filter 2 dose 14 gr	RANCILIO FAEMA		Bordo/Border: Ø 70 mm Altezza/Height 24,5 mm Canalino / Groove: Esterno/ External Passo Foratura / Distance Between Holes: 1,73 mm Esagonale / Exagonal
3126168	Filtro 2 dosi 14 gr economico Filter 2 doses 14 gr ec.	RANCILIO FAEMA		Bordo/Border: Ø 70 mm Altezza/Height 24,5 mm Canalino / Groove: Esterno/ External Passo Foratura / Distance Between Holes: 1,73 mm Esagonale / Exagonal
3126254	Filtro 2 dosi basso 12 gr Filter 2 doses short 12 gr	RANCILIO FAEMA		Bordo/Border: Ø 70 mm Altezza/Height 21 mm Canalino / Groove: Esterno/ External Passo Foratura / Distance Between Holes: 1,73 mm Esagonale / Exagonal
3126259	Filtro 2 dosi basso economico 12 gr Filter 2 doses short ec. 12 gr	RANCILIO FAEMA		Bordo/Border: Ø 70 mm Altezza/Height 21 mm Canalino / Groove: Esterno/ External Passo Foratura / Distance Between Holes: 1,73 mm Esagonale / Exagonal
3126014	Filtro 2 dosi Filter 2 doses	CIMBALI		Bordo/ Border: Ø 68 mm Altezza/Height 25 mm Canalino/Groove: : Interno C/ Internal C Passo Foratura / Distance Between Holes: 1,73 mm Esagonale / Exagonal
3126253	Filtro 2 dosi basso Filter 2 doses short	CIMBALI		Bordo/ Border: Ø 68 mm Altezza/Height 22 mm Canalino/Groove: : Interno C/ Internal C Passo Foratura / Distance Between Holes: 1,73 mm Esagonale / Exagonal

CODICE S&P S&P CODE	DESCRIZIONE DESCRIPTION	ADATTABILITA' ADAPTABILITY		CARATTERISTICHE TECNICHE TECHNICAL SPECIFICATIONS
3126017	Filtro 2 dosi 18 gr Filter 2 doses 18 gr	SAN MARCO		Bordo/ Border: Ø 66 mm Altezza/Height: 28,5 mm Canalino / Groove: Esterno/ External Passo Foratura/Distance Between Holes: 1,5 mm Micro
3126170	Filtro 2 dosi 21 gr Filter 2 doses 21 gr	SAN MARCO		Bordo/ Border: Ø 66 mm Altezza/Height: 32 mm Canalino / Groove: Esterno/ External Passo Foratura/ Distance Between Holes: 1,5 mm Micro
3126008	Filtro 2 dosi 14 gr Filter 2 doses 14 gr	SPAZIALE		Bordo/ Border: Ø 65 mm Altezza/Height: 27,5 mm Canalino/ Groove: : Esterno /External Passo Foratura/ Distance Between Holes: 1,5 mm Micro
3126019	Filtro 2 dosi 14 gr Filter 2 doses 14 gr	GAGGIA CARIMALI		Bordo/ Border: Ø 70 mm Altezza/Height 24,5 mm Canalino/ Groove: : Esterno /External Passo Foratura/ Distance Between Holes: 1,5 mm Micro
3126251	Filtro 2 dosi 14 gr Filter 2 doses 14 gr	C.M.A. FAEMA		Bordo/ Border: Ø 70 mm Altezza/Height 24,5 mm Canalino/ Groove: : Esterno /External Passo Foratura/ Distance Between Holes: 1,5 mm Micro

FILTRI CIECHI / BLIND FILTERS

CODICE S&P S&P CODE	DESCRIZIONE DESCRIPTION	ADATTABILITA' ADAPTABILITY		CARATTERISTICHE TECNICHE TECHNICAL SPECIFICATIONS
3126010	Filtro cieco basso Blind filter short	RANCILIO FAEMA		Bordo/Border: Ø 70 mm Altezza/Height: 17 mm
3126256	Filtro cieco alto Blind filter high	SPAZIALE		Bordo/Border: Ø 65 mm Altezza/Height: 25 mm
3126257	Filtro cieco Blind filter	SAN MARCO		Bordo/Border: Ø 66 mm Altezza/Height: 22 mm
3126187	Membrana cieca pulizia gruppo Membrane filter for group	UNIVERSALE		Bordo/Border: Ø 50 mm
3126299	Filtro cialda Pod Filter	BRASILIA		Altezza/Height: 17 mm

FILTRO 3 DOSI / FILTER 3 DOSES

CODICE S&P S&P CODE	DESCRIZIONE DESCRIPTION	ADATTABILITA' ADAPTABILITY		CARATTERISTICHE TECNICHE TECHNICAL SPECIFICATIONS
3126050	Filtro 3 dosi 24gr Filter 3 doses 24gr	UNIVERSALE		Bordo/Border: Ø 70 mm Altezza/Height: 28mm Passo Foratura / Distance Between Holes: 1,73 mm Esagonale / Exagonal

FILTRI CIALDA E.S.E. / POD FILTERS MONODOSES





CODICE S&P S&P CODE	DESCRIZIONE DESCRIPTION	ADATTABILITA' ADAPTABILITY		CARATTERISTICHE TECNICHE TECHNICAL SPECIFICATIONS
3126327	FILTRO CIALDA 1 DOSE H 16MM POD FILTER 1 DOSE H 16MM	UNIVERSALE		Bordo/Border: Ø 70 mm Altezza/Height: 16,00mm Passo Foratura / Distance Between Holes: 1,73 mm Esagonale / Exagonal Ø 30 mm
3126328	FILTRO CIALDA 1 DOSE H 16,5MM POD FILTER 1 DOSE H 16,5MM	UNIVERSALE		Bordo/Border: Ø 70 mm Altezza/Height: 16,50mm Passo Foratura / Distance Between Holes: 1,73 mm Esagonale / Exagonal Ø 30 mm
3126299	FILTRO CIALDA 1 DOSE H 17MM POD FILTER 1 DOSE H 17MM	UNIVERSALE		Bordo/Border: Ø 70 mm Altezza/Height: 17,00mm Passo Foratura / Distance Between Holes: 1,73 mm Esagonale / Exagonal Ø 30 mm
3126329	FILTRO CIALDA 1 DOSE H 17,5MM POD FILTER 1 DOSE H 17,5MM	UNIVERSALE		Bordo/Border: Ø 70 mm Altezza/Height: 17,50mm Passo Foratura / Distance Between Holes: 1,73 mm Esagonale / Exagonal Ø 30 mm
3126330	FILTRO CIALDA 1 DOSE H 18MM POD FILTER 1 DOSE H 18MM	UNIVERSALE		Bordo/Border: Ø 70 mm Altezza/Height: 18,00mm Passo Foratura / Distance Between Holes: 1,73 mm Esagonale / Exagonal Ø 30 mm
3126331	FILTRO CIALDA 1 DOSE H 18,5MM POD FILTER 1 DOSE H 18,5MM	UNIVERSALE		Bordo/Border: Ø 70 mm Altezza/Height: 18,50mm Passo Foratura / Distance Between Holes: 1,73 mm Esagonale / Exagonal Ø 30 mm



CODICE S&P S&P CODE	DESCRIZIONE DESCRIPTION	ADATTABILITA' ADAPTABILITY		CARATTERISTICHE TECNICHE TECHNICAL SPECIFICATIONS
3126332	FILTRO CIALDA 1 DOSE H 19MM POD FILTER 1 DOSE H 19MM	UNIVERSALE		Bordo/Border: Ø 70 mm Altezza/Height: 19,00mm Passo Foratura / Distance Between Holes: 1,73 mm Esagonale / Exagonal Ø 30 mm

FILTRI CIALDA BIDOSE / POD FILTERS TWO DOSES

CODICE S&P S&P CODE	DESCRIZIONE DESCRIPTION	ADATTABILITA' ADAPTABILITY		CARATTERISTICHE TECNICHE TECHNICAL SPECIFICATIONS
3126333	FILTRO CIALDA 2 DOSI H 21MM POD FILTER 2 DOSES H 21MM	UNIVERSALE		Bordo/Border: Ø 70 mm Altezza/Height: 21mm Passo Foratura / Distance Between Holes: 1,73 mm Esagonale / Exagonal Ø 33 mm
3126334	FILTRO CIALDA 2 DOSI H 22MM POD FILTER 2 DOSES H 22MM	UNIVERSALE		Bordo/Border: Ø 70 mm Altezza/Height: 22mm Passo Foratura / Distance Between Holes: 1,73 mm Esagonale / Exagonal Ø 33 mm
3126335	FILTRO CIALDA 2 DOSI H 23MM POD FILTER 2 DOSES H 23MM	UNIVERSALE		Bordo/Border: Ø 70 mm Altezza/Height: 23mm Passo Foratura / Distance Between Holes: 1,73 mm Esagonale / Exagonal Ø 33 mm

ADATTATORI PER CAPSULE EP E FAP MONODOSE /
MONODOSE ADAPTERS FOR EP AND FAP CAPSULES

CODICE S&P S&P CODE	DESCRIZIONE DESCRIPTION	ADATTABILITA' ADAPTABILITY		CARATTERISTICHE TECNICHE TECHNICAL SPECIFICATIONS
3126340	FILTRO ADATTATORE RIDOTTO REDUCED MONODOSE ADAPTER	FAEMA E 61 RIDOTTO FAEMA E61 REDUCED		Beccuccio integrato con uscita a croce / Integrated sprout with cross Guarnizione di tenuta sul fondo / Integrated gasket on the bottom
3126341	FILTRO ADATTATORE E61 E COMPATIBILI MONODOSE ADAPTER E61 AND COMPATIBLES	FAEMA E 61 E COMPATIBILI FAEMA E61 AND COMPATIBLES		Beccuccio integrato con uscita a croce / Integrated sprout with cross Guarnizione di tenuta sul fondo / Integrated gasket on the bottom
3126342	FILTRO ADATTATORE MAGGIORATO E61 PLUS MONODOSE ADAPTER E61 AND COMPATIBLES	FAEMA E 61 E COMPATIBILI FAEMA E61 AND COMPATIBLES		Beccuccio integrato con uscita a croce / Integrated sprout with cross Guarnizione di tenuta sul fondo / Integrated gasket on the bottom
3126343	FILTRO ADATTATORE CIMBALI CIMBALI MONODOSE ADAPTER	CIMBALI E COMPATIBILI CIMBALI AND COMPATIBLES		Beccuccio integrato con uscita a croce / Integrated sprout with cross Guarnizione di tenuta sul fondo / Integrated gasket on the bottom

CODICE S&P S&P CODE	DESCRIZIONE DESCRIPTION	ADATTABILITA' ADAPTABILITY		CARATTERISTICHE TECNICHE TECHNICAL SPECIFICATIONS
3126344	<p>FILTRO ADATTATORE SAN MARCO</p> <p>SAN MARCO MONODOSE ADAPTER</p>	<p>SAN MARCO E COMPATIBILI</p> <p>SAN MARCO AND COMPATIBLES</p>		<p>Beccuccio integrato con uscita a croce / Integrated sprout with cross</p> <p>Guarnizione di tenuta sul fondo / Integrated gasket on the bottom</p>
3126345	<p>FILTRO ADATTATORE LA SPAZIALE</p> <p>LA SPAZIALE MONODOSE ADAPTER</p>	<p>LA SPAZIALE E COMPATIBILI</p> <p>LA SPAZIALE AND COMPATIBLES</p>		<p>Beccuccio integrato con uscita a croce / Integrated sprout with cross</p> <p>Guarnizione di tenuta sul fondo / Integrated gasket on the bottom</p>

2102001 SPESSORE
RANCILIO/FAEMA/GA
GGIA /
THICKNESS GASKET
RANCILI/FAEMA

36221001:

RANCILIO SPA

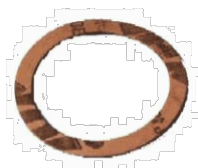

2102015 SPESSORE
GUARNITAL
CIMBALI/BRASILIA/SI
MONELLI /
GUARNITAL
THICKNESS GASKET
CIMBALI/BRASILIA/SI
MONELLI

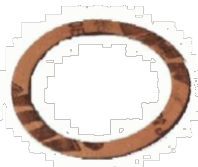

2102035 SPESSORE
SOTTOCOPPA SAN
MARCO/SPAZIALE /
FILTER-HOLDER
THICKNESS GASKET
SAN MARCO

2102035:

LA SPAZIALE SPA

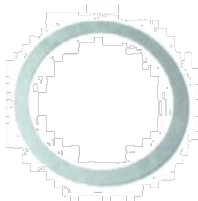

2102002 GUARNIZIO
NE SOTTOCOPPA
RANCILIO /
FILTER HOLDER
GASKET RANCILIO

19003:

MAGISTER SISTEMA
CAFFE' SRL

36301001:

RANCILIO SPA



2102043 SOTTOCOPP
A BETSY /
FILTER-HOLDER
BETSY

36301031:

RANCILIO SPA



2102051 GUARNIZIO
NE SOTTOCOPPA MISS
RANCILIO /
FILTER-HOLDER
GASKET MISS
RANCILIO

36301030:

RANCILIO SPA



2102003 SOTTOCOPP
A SAN MARCO /
FILTER HOLDER
GASKET SAN MARCO



2102124 SOTTOCOPP
A CARIMALI /
FILTER HOLDER
GASKET CARIMALI



2102039 GUARNIZIO
NE SOTTOCOPPA
FAEMA SP 8 /
FILTER HOLDER
GASKET FAEMA SP8

12217:

CMA MACCHINE PER
CAFFE' SRL



2102009 SOTTOCOPP
A FAEMAH 8,5 /
FILTER HOLDER
GASKET FAEMA
H.8,5mm

+

CMA MACCHINE PER
CAFFE' SRL



2102278 GUARN.SOT
TOCOPPA ASTORIA
72X56X8,5 SPACCHI
INTERNI /
FILTER HOLDER
GASKET ASTORIA
72X56X8,6

12217*:

CMA MACCHINE PER
CAFFE' SRL



2102008 SOTTOCOPP
A FAEMA H. 9MM /
FILTER HOLDER
GASKET FAEMA
H.9mm



2102010 GUARNIZIO
NE SOTTOCOPPA
CIMBALI CONICA /
CONICAL FILTER
HOLDER GASKET
CIMBALI



2102901 GUARNIZIO
NE SOTTOCOPPA
CONICA CIMBALI
(GNL) /
CONICAL FILTER
HOLDER GASKET
CIMBALI (GNL)

401261010:

GRUPPO CIMBALI SPA



2102065 SOTTOCOPP
A GAGGIA H9 /
FILTER-HOLDER
GASKET GAGGIA H9



2102078 SOTTOCOPP
A SPAZIALE /
FILTER-HOLDER
GASKET SPAZIALE

2102078:
LA SPAZIALE SPA



2102446 GUARNIZIO
NE SOTTOCOPPA
LEVA /
LEVER FILTER
HOLDER GASKET

190050:
MAGISTER SISTEMA
CAFFE' SRL



2102468 SOTTOCOPP
A H 8,5 /
LEVEL FILTER
HOLDER H 8.5

190059:
MAGISTER SISTEMA
CAFFE' SRL



2102247 GUARNIZIO
NE SOTTOCOPPA
NUOVA SIMONELLI /
FILTER HOLDER
GASKET NUOVA
SIMONELLI

02280020V:
NUOVA SIMONELLI
SPA



2102495 GUARNIZIO
NE SOTTOCOPPA
WEGA 64X52X6,5 CTS
05 /

LEVEL FILTER
HOLDER WEGA
64X52X6,5 CTS 05

W12217001:
WEGA MACCHINE
PER CAFFE' SRL



2102004 GUARNIZIO
NE RUBINETTO
VAPORE RANCILIO-
FAEMA-BRASILIA /
STEAM TAP GASKET
RANCILIO

362027:
LA PAVONI SPA
1200500002:
BRASILIA SPA
36301008:
RANCILIO SPA
36301008:

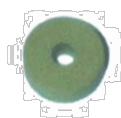

**MAGISTER SISTEMA
CAFFE' SRL**

2102297 GUARNIZIO
NE VALVOLA AT /
VALVE GASKET

36301009:
RANCILIO SPA



2102327 GUARNIZIO
NE PASTIGLIA
VALVOLA /
VALVE GASKET

36302001:
RANCILIO SPA



2102005 GUARNIZIO
NE A PASTIGLIA
VERDE /
GREEN VALVE
GASKET

36302002:
RANCILIO SPA



2102020 GUARNIZIO
NE FAEMA 28000
TENERA /
GASKET FAEMA 28000



2102040 GUARNIZIO
NE VAPORE
FUTURMAT /
STEAM GASKET
FUTURMAT



2102475 GUARNIZIO
NE DIAMETRO 14
TENUTA RUBINETTO /
SEAL GASKET COCK
DIAMETER 14

00221:
LA SPAZIALE SPA



2102517 GUARNIZIO
NE IN KLINGHER
DIAMETRO 11,5mm
SPESSORE 2mm /
GASKET KLINGHER
D.11,5MM THICKNES
2MM

02228:
LA SPAZIALE SPA



2102518 GUARNIZIO
NE TENUTA /
GASKET

00290:

LA SPAZIALE SPA



2102600 GUARNIZIO
NE VETRO LIVELLO
VITON spaziale ø 17.2/13
mm - internal ø 11 mm--
height 9/4 mm /
FLAT EPDM GASKET

00266:

LA SPAZIALE SPA



DIAMETER = 11mm

2102516 GUARNIZIO
NE VETRO LIVELLO
SILICONE /
LEVEL GLASS GASKET

00265:

LA SPAZIALE SPA



2102578 GUARNIZIO
NE GOMMA
TRAMOGGIA /
GASKET RUBBER
HOPPER

MT103:

OBEL SRL



2102487 GUARNIZIO
NE PREMISTOPPA
RUBINETTO WEGA /
WEGA SEAL GASKET
VALVE

WY12204:

WEGA MACCHINE
PER CAFFE' SRL



2102021 GUARNIZIO
NE WEGA RUBINETTO
/

TAP GASKET WEGA
WY12203:

WEGA MACCHINE
PER CAFFE' SRL



2102050 GUARNIZIO
NE LIVELLO WEGA /
LEVEL GLASS GASKET
WEGA



2102183 GUARNIZIO
NE COLL. ASTA PV-
GOMMA /

PV-RUBBER ROD
COLLAR GASKET

36101002:

RANCILIO SPA

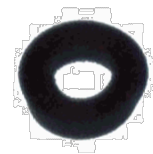

2102016 COLLARE 1
GOLA GR LE RANCILIO
/
COLLAR 1 GROOVE
LEVER SET RANCILIO

36101006:

RANCILIO SPA

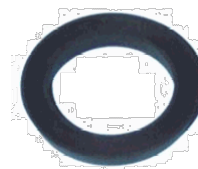

2102017 COLLARE 2
GOLE GR. LE
RANCILIO /
COLLAR 2 GROVES
LEVER SET RANCILIO

36101005:

RANCILIO SPA



2102351 GUARNIZIO
NE CALDAIA
RANCILIO 8 FORI CLX /
GASKET BOILER
RANCILIO 8 HOLES
CLX

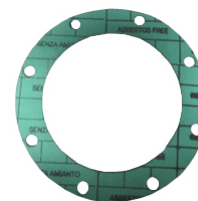

2102469 GUARNISO
LANTE GRUPPO
ESTERNO /
THICKNESS GASKET

190034:

MAGISTER SISTEMA
CAFFE' SRL

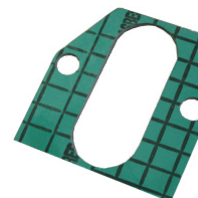

2102426 GUARNIZIO
NE ISOLAMENTO
GRUPPO /
THICKNESS GASKET



2102036 GUARNIZIO
NE RAME 3/8 23X17X1 /
TAP COPPER GASKET
3/8 23X17X1

12154:

CMA MACCHINE PER
CAFFE' SRL

27350001:

RANCILIO SPA



2102216 GUARNIZIO
NE 1/4 GAS /
COPPER GASKET 1/4
27270001:
RANCILIO SPA



2102019 GUARNIZIO
NE RAME 21X27X1 1/2 /
COPPER GASKET
21X27X1 1/2
27400001:
RANCILIO SPA



2102323 GUARNIZIO
NE PER SONDA
TERMICA FAEMA /
PROBE GASKET
FAEMA



2102037 GUARNIZIO
NE CALDAIA S27 /
BOILER GASKET S27
36220018:
RANCILIO SPA

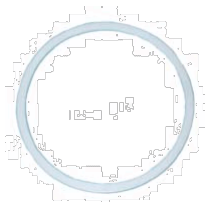

2102041 GUARNIZIO
NE GIGLEUR /
GIGLEUR GASKET
36220008:
RANCILIO SPA
437030:
ELETTROBAR
DIVISIONE DELLA
EUROTEC SRL

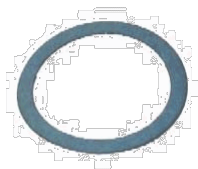

2102107 GUARN.
TUBO CARICO LT 3/4 /
LOAD PIPE GASKET 3/4
2102107:
GRUPPO CIMBALI SPA

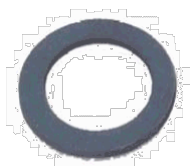

2102182 GUARNIZIO
NE RACCORDO
CALDAIA LT-LS /
BOILER CONNECTION
GASKET LT-LS
36220010:
RANCILIO SPA

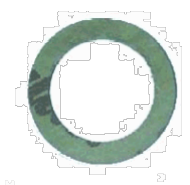

2107087 GUARNIZIO
NE PTFE 18-22-2 /
GASKET PTFE 18-22-2
986005000: GRUPPO
CIMBALI SPA



2107088 GUARNIZIO
NE TEFLON COLON.NP
/
TEFLON GASKET NP
9111002ex:
GRUPPO CIMBALI
SPA



2107007 RONDELLA
PERNO GIRANTE
LT/SN /
ROD PIVOT WASHER
LT/SN
36930096:
RANCILIO SPA



2107017 RONDELLA
TEFLON NERO GR NE /
BLACK TEFLON ROD
GR NE
36230006:
RANCILIO SPA

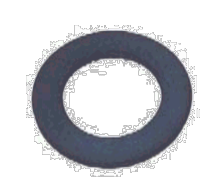

2107004 GUARNIZIO
NE TEFLON
RUBINETTO /
TAP TEFLON GASKET
36230001:
RANCILIO SPA

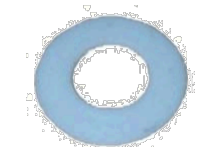

2102014 GUARNIZIO
NE RESISTENZA
RANCILIO /
HEATING ELEMENT
GASKET RANCILIO
36220003:
RANCILIO SPA

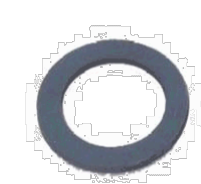

2102034 GUARNIZIO
NE RESISTENZA N.T.
SAN MARCO /
HEATING ELEMENT
GASKET N.T. SAN
MARCO

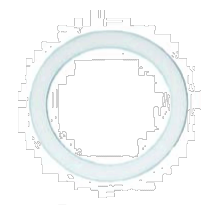

2102130 GUARNIZIO
NE RESISTENZA
FAEMA /
HEATING ELEMENT
GASKET FAEMA

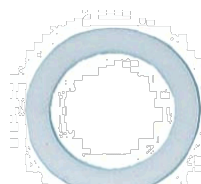

2102134 GUARNIZIO
NE RESISTENZA
CIMBALI /
HEATING ELEMENT
GASKET CIMBALI

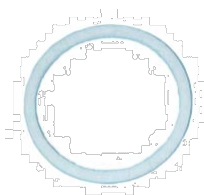

2107045 GUARNIZIO
NE RESISTENZA
SPAZIALE / HEATING
ELEMENT GASKET
SPAZIALE

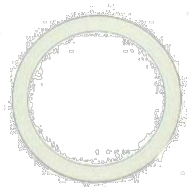

2107046 GUARNIZIO
NE TEFLON GHIERA
SCAMB.SPAZIALE /
EXCHANGER METAL
RING TEFLON GASKET
SPAZIALE

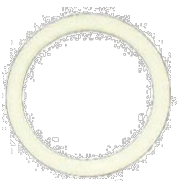

2107079 GUARNIZIO
NE RESISTENZA
VBM/BRASILIA /
HEATING ELEMENT
GASKET
VBM/BRASILIA
0081900002:
BRASILIA SPA
190043:
MAGISTER SISTEMA
CAFFE' SRL



2107114 GUARNIZIO
NE FISSAGGIO
GRUPPO AURORA
TEFLON /
GASKET TEFLON



2107080 GUARNIZIO
NE FLANGIA GRUPPO
CALDAIA CMA /
BOILER GASKET CMA
12002:
CMA MACCHINE PER
CAFFE' SRL
190044:
MAGISTER SISTEMA
CAFFE' SRL



2102026 GUARNIZIO
NE CALDAIA
RANCILIO O. /
BOILER GASKET
RANCILIO
36930011:
RANCILIO SPA

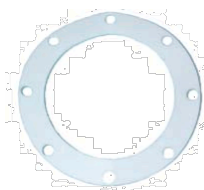

2102028 GUARNIZIO
NE VSM RANCILIO T. /
GASKET VSM
RANCILIO
36220006:
RANCILIO SPA

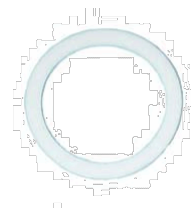

2102090 GUARNIZIO
NE CALDAIA L4/6/7 /
BOILER GASKET L4/6/7
36220017:
RANCILIO SPA

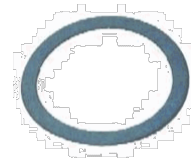

2107041 GUARNIZIO
NE CALDAIA CIMBALI
6 FORI D.180 /
BOILER GASKET
CIMBALI 6 HOLES
D.180

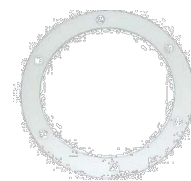

2107024 GUARNIZIO
NE FAEMA T.CALDAIA
12F /
BOILER TEFLON
GASKET FAEMA 12F

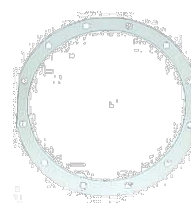

2107019 GUARNIZIO
NE CALDAIA FAEMA
P4 TEFL. /
BOILER TEFLON
GASKET FAEMA P4



2107042 GUARNIZIO
NE CALDAIA
SPAZIALE 8 FORI /
BOILER GASKET
SPAZIALE 8 HOLES

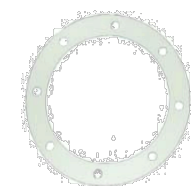

2107043 GUARNIZIO
NE 6 FORI
GR.SPAZIALE /
GASKET SPAZIALE 6
HOLES

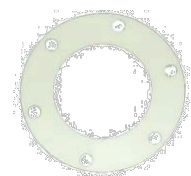

2107044 GUARNIZIO
NE CALDAIA
SPAZIALE 3000 TN /
BOILER GASKET
SPAZIALE 3000 TN

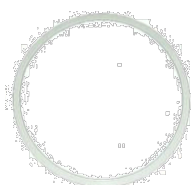

2107081 GUARNIZIO
NE CALDAIA
164X152X4 /
BOILER GASKET
164X152X4
190042:
**MAGISTER SISTEMA
CAFFE' SRL**



2107018 GUARNIZIO
NE CALDAIA WEGA
11F TEFLON /
BOILER TEFLON
GASKET WEGA 11F



2102101 GUARNIZIO
NE CONO TEFLON
RUB. S.MARCO /
TEFLON CONE
GASKET FOR COCK
SAN MARCO



2107147 GUARNIZI
ONE 1"1/4 /
"GASKET 1"1/4"



2107006 GUARNIZI
ONE FAEMA FUNGO
TEFLON /
TEFLON FUNGUS
GASKET FAEMA



2102018 GUARNIZI
ONE DADO SNODO /
ARTICULATION NUT
GASKET
36220009:
RANCILIO SPA

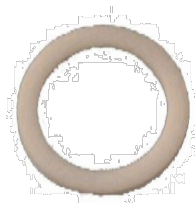

2107157 GUARNIZI
ONE 14,5X10X1,5 PTFE
/
TEFLON GASKET
14,5X10X1,5

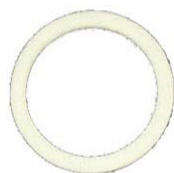

2107162 GUARNIZI
ONE 20X10X1,5 PTFE /
GASKET 20X10X1,5
PTFE



= 1125138

2107186 BUSSOLA
TEFLON RUB. E/91 -
DUE D.15X7,5X10,3 /
BUSH TAP E91/DUE
D.15X7,5X10,3



2107199 Tenuta
Teflon Vap-Acqua /
TEFLON GASKET FOR
TAP



2107211 BOCCOLA
COPERCHIO
POSTERIORE
MOTORIDUTTORE /
BUSH BACK COVER
GEARMOTOR
2280022300:
UGOLINI SPA



2107178 CALOTTA
IN GOMMA BOCCOLA
Ø 13 MM /
RUBBER BUSH
1002803215:
UGOLINI SPA



2107179 BOCCOLA
AUTOLUBRIFICANTE
MOTORIDUTTORE /
MOTOREDCER BUSH
1002803204:
UGOLINI SPA



2102209 GUARNIZI
ONE SILICONE
RUBINETTI
DISPENSER /
SILICON GASKET FOR
COCK DISPENSER



2102535 GUARNIZI
ONE A VENTOSA /
SUCTION CUP SEAL



2102011 GUARNIZIO
NE LIVELLO CIMBALI
/
LEVEL GASKET
CIMBALI



2107087 GUARNIZIO
NE PTFE 18-22-2 /
GASKET PTFE 18-22-2
986005000: GRUPPO
CIMBALI SPA



2107088 GUARNIZIO
NE TEFLON COLON.NP
/
TEFLON GASKET NP
9111002ex:
GRUPPO CIMBALI
SPA



2107007 RONDELLA
PERNO GIRANTE
LT/SN /
ROD PIVOT WASHER
LT/SN
36930096:
RANCILIO SPA

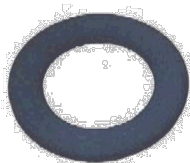

2107017 RONDELLA
TEFLON NERO GR NE /
BLACK TEFLON ROD
GR NE
36230006:
RANCILIO SPA



2107004 GUARNIZIO
NE TEFLON
RUBINETTO /
TAP TEFLON GASKET
36230001:
RANCILIO SPA

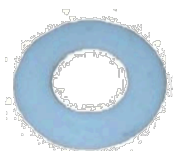

2102014 GUARNIZIO
NE RESISTENZA
RANCILIO /
HEATING ELEMENT
GASKET RANCILIO
36220003:
RANCILIO SPA

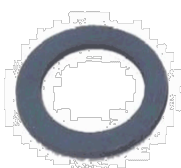

2102034 GUARNIZIO
NE RESISTENZA N.T.
SAN MARCO /
HEATING ELEMENT
GASKET N.T. SAN
MARCO

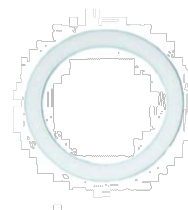

2102130 GUARNIZIO
NE RESISTENZA
FAEMA /
HEATING ELEMENT
GASKET FAEMA

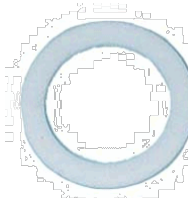

2102134 GUARNIZIO
NE RESISTENZA
CIMBALI /
HEATING ELEMENT
GASKET CIMBALI

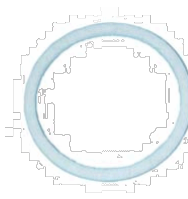

2107045 GUARNIZIO
NE RESISTENZA
SPAZIALE / HEATING
ELEMENT GASKET
SPAZIALE

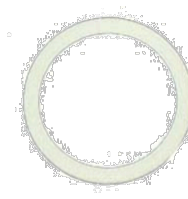

2107046 GUARNIZIO
NE TEFLON GHIERA
SCAMB.SPAZIALE /
EXCHANGER METAL
RING TEFLON GASKET
SPAZIALE

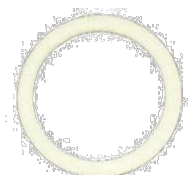

2107079 GUARNIZIO
NE RESISTENZA
VBM/BRASILIA /
HEATING ELEMENT
GASKET
VBM/BRASILIA
0081900002:
BRASILIA SPA
190043:
MAGISTER SISTEMA
CAFFE' SRL



2107114 GUARNIZIO
NE FISSAGGIO
GRUPPO AURORA
TEFLON /
GASKET TEFLON



2107080 GUARNIZIO
NE FLANGIA GRUPPO
CALDAIA CMA /
BOILER GASKET CMA
12002:
CMA MACCHINE PER
CAFFE' SRL
190044:
MAGISTER SISTEMA
CAFFE' SRL

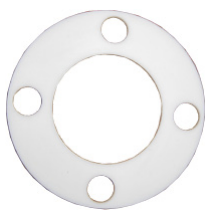

2102026 GUARNIZIO
NE CALDAIA
RANCILIO O. /
BOILER GASKET
RANCILIO
36930011:
RANCILIO SPA

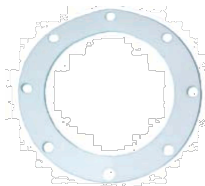

2102028 GUARNIZIO
NE VSM RANCILIO T. /
GASKET VSM
RANCILIO
36220006:
RANCILIO SPA

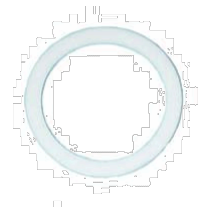

2102090 GUARNIZIO
NE CALDAIA L4/6/7 /
BOILER GASKET L4/6/7
36220017:
RANCILIO SPA

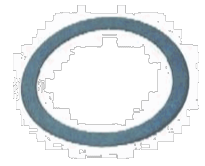

2107041 GUARNIZIO
NE CALDAIA CIMBALI
6 FORI D.180 /
BOILER GASKET
CIMBALI 6 HOLES
D.180

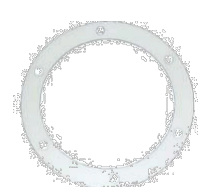

2107024 GUARNIZIO
NE FAEMA T.CALDAIA
12F /
BOILER TEFLON
GASKET FAEMA 12F

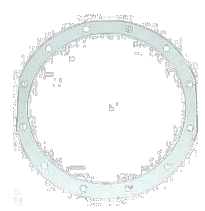

2107019 GUARNIZIO
NE CALDAIA FAEMA
P4 TEFL. /
BOILER TEFLON
GASKET FAEMA P4



2107042 GUARNIZIO
NE CALDAIA
SPAZIALE 8 FORI /
BOILER GASKET
SPAZIALE 8 HOLES

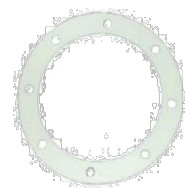

2107043 GUARNIZIO
NE 6 FORI
GR.SPAZIALE /
GASKET SPAZIALE 6
HOLES

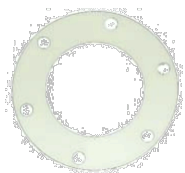

2107044 GUARNIZIO
NE CALDAIA
SPAZIALE 3000 TN /
BOILER GASKET
SPAZIALE 3000 TN

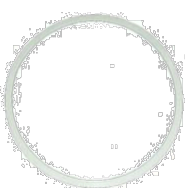

2107081 GUARNIZIO
NE CALDAIA
164X152X4 /
BOILER GASKET
164X152X4
190042:
MAGISTER SISTEMA
CAFFE' SRL



2107018 GUARNIZIO
NE CALDAIA WEGA
11F TEFLON /
BOILER TEFLON
GASKET WEGA 11F



2102101 GUARNIZIO
NE CONO TEFLON
RUB. S.MARCO /
TEFLON CONE
GASKET FOR COCK
SAN MARCO



2102011 GUARNIZIO
NE LIVELLO CIMBALI /
LEVEL GASKET
CIMBALI



2107147 GUARNIZIO
NE 1"1/4 /
"GASKET 1"1/4"



2107006 GUARNIZIO
NE FAEMA FUNGO
TEFLON /
TEFLON FUNGUS
GASKET FAEMA

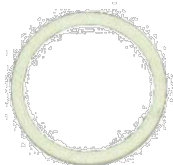

2102018 GUARNIZIO
NE DADO SNODO /
ARTICULATION NUT
GASKET
36220009:
RANCILIO SPA



2107157 GUARNIZIO
NE 14,5X10X1,5 PTFE /
TEFLON GASKET
14,5X10X1,5

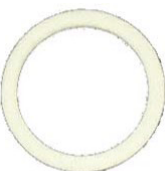

2107162 GUARNIZIO
NE 20X10X1,5 PTFE /
GASKET 20X10X1,5
PTFE



= 1125138

2107186 BUSSOLA
TEFLON RUB. E/91 -
DUE D.15X7,5X10,3 /
BUSH TAP E91/DUE
D.15X7,5X10,3



2107199 Tenuta Teflon
Vap-Acqua /
TEFLON GASKET FOR
TAP



2102209 GUARNIZIO
NE SILICONE
RUBINETTI DISPENSER
/
SILICON GASKET FOR
COCK DISPENSER



2102535 GUARNIZIO
NE A VENTOSA /
SUCTION CUP SEAL



2101031 GUARNIZI
ONE OR D. 37X5.33 /
O RING D.37 47X5.33
29938:

HOONVED - ALI
SPA

103415: KRUPPS
S.R.L.

36404015:

RANCILIO SPA

907981:

SILANOS SRL

456075:

ELETTROBAR

DIVISIONE DELLA

EUROTEC SRL

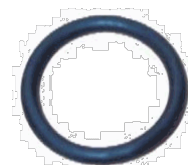

2101032 GUARNIZI
ONE OR D. 46 99X5.33
/

O RING D.46 99X5.33

H200820:

HOONVED - ALI
SPA

2707069:

WINTERHALTER

ITALIA SRL

2188400: LASA SRL

DW13005:

DIHR-ALI SPA

067620:

ELECTROLUX

PROFESSIONAL

S.P.A.

REB456002:

LOTUS SPA

4207*: A.T.A. SRL

2662:

ARISTARCO SPA

456002:

ELETTROBAR

DIVISIONE DELLA

EUROTEC SRL

200820:

COMENDA ALI SPA

*:

EUROTEC SRL - DIV.

COOKING SERVICE

MBM

4011:

UNIVER-BAR SRL

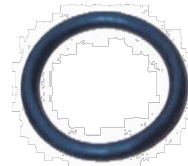

2101033 GUARNIZI
ONE OR D. 56 52X5.33

/
O RING D.56 52X5.33

H200815:

HOONVED - ALI
SPA

0200041:

LAMBER DI AFFABA
FRANCESCO & C.

DW13015:

DIHR-ALI SPA

3150430:

ANGELO PO
GRANDI CUCINE
SPA

200815:

COMENDA ALI SPA

103445:

KRUPPS S.R.L.

12010040:

FAGOR
INDUSTRIALE
S.R.L.

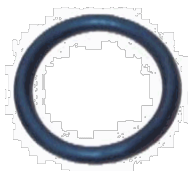

2101312 10,82X1,78

O-RING NBR /
O-RING NBR
10,82X1,78

60073: ADLER S.P.A.



2101318 18,77X1,78

O-RING NBR /
O-RING NBR
18,77X1,78

3150840:

ANGELO PO
GRANDI CUCINE
SPA



2101485 47,23X3,53

O-RING NBR /
O-RING NBR
47,23X3,53

3152151:

ANGELO PO
GRANDI CUCINE
SPA

3831:

UNIVER-BAR SRL

536009800: LOTUS

SPA



2101477 37,70X3,53

O-RING NBR /
O-RING NBR
37,70X3,53

4698:

ARISTARCO SPA

DW13022:

DIHR-ALI SPA



2101387 15,88X2,62

O-RING NBR / O-RING
NBR 15,88X2,62

93: ARISTARCO SPA

01471:

LA SPAZIALE SPA



2101321 23,52X1,78

O-RING NBR /
O-RING NBR
23,52X1,78

4643: A.T.A. SRL



2101470 26,57X3,53

O-RING NBR /
O-RING NBR
26,57X3,53

OR4106:

ANGELO PO
GRANDI CUCINE
SPA



2101058 GUARNIZI

ONE OR X FLANGIA
NBR /
OR FOR HEATING
HELEMENT

57: ARISTARCO SPA



2101407 40,95X2,62

O-RING NBR /
O-RING NBR
40,95X2,62

20429:

BREMA ICE MAKERS
SPA



2101385 15,08X2,62

O-RING NBR /
O-RING NBR
15,08X2,62

12303:

CMA MACCHINE
PER CAFFE' SRL

*:MBM

456045:

ELETTROBAR



2101406 39,35X2,62

O-RING NBR /
O-RING NBR
39,35X2,62

12300000:

CMA MACCHINE PER
CAFFE' SRL

32243:

HOONVED - ALI
SPA

DW13006: DIHR

3337:

UNIVER-BAR SRL



2101398 26,65X2,62
O-RING NBR /
O-RING NBR
26,65X2,62
200805:
COMENDA ALI SPA
2250001302:
UGOLINI SPA



2101596 81,92X5,34
O-RING NBR /
O-RING NBR
81,92X5,34
200829:
COMENDA ALI SPA



2101716 63,50X3,53
O-RING NBR /
O-RING NBR
63,50X3,53
200853:
COMENDA ALI SPA



2101132 GUARNIZI
ONE OR 2X9,5X13,5
F.S. /
O-RING 2X9,5X13,5
F.S.
200844:
COMENDA ALI SPA



2101539 183,75X3,5
3 O-RING NBR /
O-RING NBR
183,75X3,53
200828:
COMENDA ALI SPA



2101332 41,00X1,78
O-RING NBR /
O-RING NBR
41,00X1,78
200833:
COMENDA ALI SPA



2101151 GUARN.O
R 3X6X12 /
O-RING 3X6X12
200854:
COMENDA ALI SPA



2101572 37,30X3,60
O-RING NBR /
O-RING NBR
37,30x3,60
200830:
COMENDA ALI SPA



2101152 GUAR. OR
81X87X3 /
O-RING 81X87X3
200856:
COMENDA ALI SPA



2101153 GUAR. OR
43X49X3 /
O-RING 43X49X3
200855:
COMENDA ALI SPA

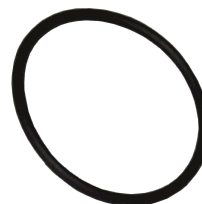

2101464 18,64X3,53
O-RING NBR /
O-RING NBR
18,64X3,53
DW60377:
DIHR-ALI SPA



2101118 OR 37X1,5 /
O-RING 37X1,5
DW89332:
DIHR-ALI SPA



2101119 OR 58X1,5 /
O-RING 58X1,5
DW89331:
DIHR-ALI SPA



2101319 20,35X1,78
O-RING NBR /
O-RING NBR
20,35X1,78
DW13018:
DIHR-ALI SPA
200849:
COMENDA ALI SPA



2101342 72,76X1,78
O-RING NBR /
O-RING NBR
72,76X1,78
DW135506:
DIHR-ALI SPA



2101403 34,60X2,62
O-RING NBR /
O-RING NBR
34,60X2,62
DW13004:
DIHR-ALI SPA



2101481 42,86X3,53
O-RING NBR /
O-RING NBR
42,86X3,53
DW13008:
DIHR-ALI SPA
1633:
ARISTARCO SPA



2101304 4,47X1,78
O-RING NBR /
O-RING NBR
4,47X1,78
DW13016:
DIHR-ALI SPA
OR103:
OMNIWASH SRL -
SOCIETA' A SOCIO
UNICO
36401003:
RANCILIO SPA



2101471 28,17X3,53
O-RING NBR /
O-RING NBR
28,17X3,53
002873:
ELECTROLUX
PROFESSIONAL
S.P.A.



2101381 11,91X2,62
O-RING SNODO
VAPORE NBR /
O-RING STEAM
ARTICULATION NBR
11,91X2,62
67292:
ELECTROLUX
36404001:
RANCILIO SPA
123: ARISTARCO
SPA
7130: A.T.A. SRL



2101521 110,72X3,5
3 O-RING NBR /
O-RING NBR
110,72X3,53
048327:
ELECTROLUX
200807:
COMENDA ALI SPA



2101391 20,29X2,62
O-RING NBR /
O-RING NBR
20,29X2,62
456010:
ELETTROBAR
DIVISIONE DELLA
EUROTEC SRL



2101513 82,14X3,53
O-RING NBR /
O-RING NBR
82,14X3,53
459008:
ELETTROBAR
DIVISIONE DELLA
EUROTEC SRL
CF64009300:
CASTEL MAC SPA



2101613 120,65X5,3
4 O-RING NBR /
O-RING NBR
120,65X5,34
456040:
ELETTROBAR
DIVISIONE DELLA
EUROTEC SRL
*:
EUROTEC SRL -
DIV. COOKING
SERVICE MBM



2101324 28,30X1,78
O-RING CONTATORE
VOLUMETRICO NBR /
O-RING
VOLUMETRIC
METER NBR
28,30X1,78
927094:
ELETTROBAR
DIVISIONE DELLA
EUROTEC SRL



2101507 69,44X3,53
O-RING NBR /
O-RING NBR
69,44X3,53
41215:
ELETTROBAR
DIVISIONE DELLA
EUROTEC SRL



2101569 32,50X3,60
O-RING COLONNA
LAV.SCAR. 1" NBR /
"O-RING DRAIN
WASHING COLUMN
1" NBR 32,50x3,60"

456016:
ELETTROBAR
DIVISIONE DELLA
EUROTEC SRL
904350:
SILANOS SRL
3150260:
ANGELO PO
GRANDI CUCINE
SPA



2101154 GUARNIZI
ONE O-RING PER
POMPA DI
LAVAGGIO /
O-RING FOR WASH
PUMP

456031*:
ELETTROBAR
DIVISIONE DELLA
EUROTEC SRL

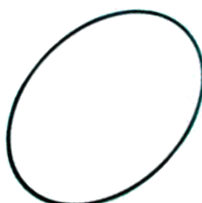

2101156 OR IN
GOMMA NBR 70SH-
94X2 /
O-RING NBR 70SH-
94X2

456022:
ELETTROBAR
DIVISIONE DELLA
EUROTEC SRL



2101165 GUANIZIO
NE O-RING X TUBO
MANDATA
CENTRALE X LAV. /
O-RING

CLEAN3, 35F, 25FD,
350F, 350FD:
ELETTROBAR



2101428 75,88X2,62
O-RING NBR /
O-RING NBR
75,88X2,62

06140004:
ELFRAMO SPA
DW10506:
DIHR-ALI SPA
REB456038:
LOTUS SPA
*: MBM
456038:
ELETTROBAR



2101380 10,78X2,62
O-RING NBR /
O-RING NBR
10,78X2,62

06140003:
ELFRAMO SPA
0083800002:
BRASILIA SPA
456006:
ELETTROBAR
DIVISIONE DELLA
EUROTEC SRL



2101512 78,97X3,53
O-RING NBR /
O-RING NBR
78,97X3,53

06140026:
ELFRAMO SPA
20205:
BREMA ICE MAKERS
SPA
2417:
LA SPAZIALE SPA



2101536 164,70X3,5
3 O-RING NBR /
O-RING NBR
164,70X3,53

06140010:
ELFRAMO SPA



2101494 56,75X3,53
O-RING NBR /
O-RING NBR
56,75X3,53

06140018:
ELFRAMO SPA



2101355 120,40X1,7
8 O-RING NBR /
O-RING NBR
120,40X1,78

06140008:
ELFRAMO SPA
REB456031:
LOTUS SPA
65456031:
RANCILIO SPA
456031:
ELETTROBAR
*:

EUROTEC SRL - DIV.
COOKING SERVICE
MBM

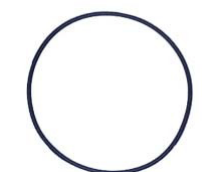

2101476 36,10X3,53

O-RING NBR /
O-RING NBR
36,10X3,53

12010165:

FAGOR
INDUSTRIALE
S.R.L.



2101421 63,17X2,62

O-RING NBR /
O-RING NBR
63,17X2,62

6090146: GIORIK
SPA



2101498 60,32X3,53

O-RING NBR /
O-RING NBR
60,32X3,53

6090140: GIORIK
SPA



2101479 40,87X3,53

O-RING NBR /
O-RING NBR
40,87X3,53

977021000:

GRUPPO CIMBALI
SPA
11315: ADLER S.P.A.
200822:
COMENDA ALI SPA
CERI46A:
OMNIWASH SRL -



2101090 GUARNIZI

ONE OR 011003 /
O-RING 011003

9011003:

GRUPPO CIMBALI
SPA



2101195 GUARNIZI

ONE OR* /
O-RING

9011001:

GRUPPO CIMBALI
SPA



2101196 GUARNIZI

ONE OR
RESIST. VASCA* /
O-RING X TANK
HEATING ELEMENT

984285000:

GRUPPO CIMBALI
SPA



2101197 GUARNIZI

ONE OR* /
O-RING

9011200:

GRUPPO CIMBALI
SPA



2101399 28,25X2,62

O-RING NBR /
O-RING NBR
28,25X2,62

25239:

HOONVED - ALI
SPA



2101187 GUARN.O

R 2X13X17 F.SER. /
O-RING 2X13X17

H200843:

HOONVED - ALI
SPA

200843:

COMENDA ALI SPA



2101394 22,23X2,62

O-RING NBR /
O-RING NBR
22,23X2,62

25238:

HOONVED - ALI
SPA

4615: A.T.A. SRL



2101413 50,47X2,62

O-RING NBR / O-RING
NBR 50,47X2,62

32310:

HOONVED - ALI
SPA

929061:

ELETTROBAR



2101137 GUARNIZI

ONE OR 1X7X9 /
O-RING 1X7X9

34360:

HOONVED - ALI
SPA

200850:

COMENDA ALI SPA



2101146 GUARNIZI

ONE OR
2,21X16,36X20,78 /
O-RING

2,21X16,36X20,78

H200813:

HOONVED - ALI
SPA

200813:

COMENDA ALI SPA



2101410 45,70X2,62
O-RING PILETTA
SCARICO NBR /
O-RING DRAIN
JUNCTION NBR
45,70X2,62

28226:

HOONVED - ALI
SPA

OR3181:

OMNIWASH SRL -

200867:

COMENDA ALI SPA

0835264561:

MODULAR SPA



2101317 17,16X1,78
O-RING NBR /
O-RING NBR
17,16X1,78

27050:

HOONVED - ALI
SPA

K01125: KASTEL SRL

200812:

COMENDA ALI SPA



2101465 20,22X3,53
O-RING NBR /
O-RING NBR
20,22X3,53

30479:

HOONVED - ALI
SPA

904404:

SILANOS SRL

200869:

COMENDA ALI SPA

1037: A.T.A. SRL

2934:

ARISTARCO SPA

20338: BREMA ICE

MAKERS SPA



2101424 67,95X2,62
O-RING NBR /
O-RING NBR
67,95X2,62

31386:

HOONVED - ALI
SPA



2101308 6,75X1,78
O-RING NBR /
O-RING NBR
6,75X1,78

31014:

HOONVED - ALI
SPA

2180300: LASA SRL

1036502900:

MARENO

INDUSTRIE ALI

SPA

OR106:

OMNIWASH SRL -

SOCIETA' A SOCIO



UNICO

2531:

ARISTARCO SPA

200818:

COMENDA ALI SPA

456030:

ELETTROBAR

DIVISIONE DELLA

EUROTEC SRL

2101309 7,66X1,78

O-RING NBR /

O-RING NBR

7,66X1,78

30475:

HOONVED - ALI
SPA

281:

LA SPAZIALE SPA

36404013:

RANCILIO SPA

4648: A.T.A. SRL



2101310 8,73X1,78

O-RING NBR /

O-RING NBR

8,73X1,78

25252:

HOONVED - ALI
SPA

OL0555:

ELECTROLUX

PROFESSIONAL

S.P.A.

200809:

COMENDA ALI SPA



2101401 31,42X2,62

O-RING NBR /

O-RING NBR

31,42X2,62

31639:

HOONVED - ALI
SPA

2016:

UNIVER-BAR SRL

DW13000:

DIHR-ALI SPA



2101416 55,25X2,62

O-RING NBR /

O-RING NBR

55,25X2,62

31948:

HOONVED - ALI
SPA

20655:

BREMA ICE MAKERS
SPA

2010051000:

STAFF ICE SYSTEM
SRL



2101392 20,64X2,62

O-RING NBR /
O-RING NBR
20,64X2,62

34332:

HOONVED - ALI
SPA

225:

LA SPAZIALE SPA

1295300002:

BRASILIA SPA

190054:

MAGISTER

OR128:

OMNIWASH SRL -

25: ARISTARCO SPA

200821:

COMENDA ALI SPA



2101426 71,12X2,62

O-RING NBR /
O-RING NBR
71,12X2,62

25245:

HOONVED - ALI
SPA

200868:

COMENDA ALI SPA



2101717 98,02X3,53

O-RING NBR /
O-RING NBR
98,02X3,53

H200803:

HOONVED - ALI
SPA

200803:

COMENDA ALI SPA



2101313 11,11X1,78

O-RING NBR /
O-RING NBR
11,11X1,78

30473:

HOONVED - ALI
SPA

CGR114:

ELETTROBAR



2101325 29,87X1,78

O-RING NBR /
O-RING NBR
29,87X1,78

25244:

HOONVED - ALI
SPA



2101302 2,90X1,78

O-RING NBR /
O-RING NBR
2,90X1,78

25251:

HOONVED - ALI
SPA



2101322 25,12X1,78

O-RING NBR /
O-RING NBR
25,12X1,78

H200817:

HOONVED - ALI
SPA

200817:

COMENDA ALI SPA



2101346 88,64X1,78

O-RING NBR /
O-RING NBR
88,64X1,78

34340:

HOONVED - ALI
SPA

DW18245:

DIHR-ALI SPA



2101348 95,00X1,78

O-RING NBR /
O-RING NBR
95,00X1,78

35497

: HOONVED - ALI
SPA

630424:

COMENDA ALI SPA

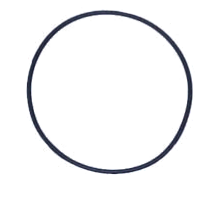

2101376 7,60X2,62

O-RING NBR /
O-RING NBR 7,60x2,62

LAR70010050:

LAINOX ALI SPA



2101478 39,70X3,53

O-RING NBR /
O-RING NBR
39,70X3,53

0200056: LAMBER

4329: UNIVER-BAR

4616: A.T.A. SRL



2101305 5,28X1,78

O-RING NBR /
O-RING NBR
5,28X1,78

0200303:

LAMBER DI AFFABA
FRANCESCO & C.

1539:

UNIVER-BAR SRL

DW13001:

DIHR-ALI SPA

OR2021:

OMNIWASH SRL -

456009:

ELETTROBAR

36404014:

RANCILIO SPA



2101314 12,42X1,78

O-RING SILANOS

NBR /

O-RING SILANOS

NBR 12,42X1,78

2188520: LASA SRL

0200103:

LAMBER DI AFFABA

FRANCESCO & C.

H200824:

HOONVED - ALI

SPA

DW13009:

DIHR-ALI SPA

OH0800:

ELECTROLUX

OR2050:

OMNIWASH SRL

1036502600:

MARENO

904320:

SILANOS SRL

200824:

COMENDA ALI SPA



2101400 29,83X2,62

O-RING NBR /

O-RING NBR

29,83X2,62

218570: LASA SRL

OR3118:

OMNIWASH SRL -

SOCIETA' A SOCIO

UNICO

2010051500:

STAFF ICE SYSTEM

SRL



2101315 14,00X1,78

O-RING NBR /

O-RING NBR

14,00X1,78

218255: LASA SRL

25243:

HOONVED - ALI

SPA

7601: A.T.A. SRL



2101408 42,52X2,62

O-RING NBR /

O-RING NBR

42,52X2,62

218750: LASA SRL

OR3168:

OMNIWASH SRL -

SOCIETA' A SOCIO

UNICO



2101306 6,07X1,78

O-RING

ELETTROVALVOLA

NBR /

O-RING SOLENOID

VALVE NBR 6,07X1,78

00625:

LA SPAZIALE SPA

067898:



ELECTROLUX

PROFESSIONAL

S.P.A.

190014:

MAGISTER

SISTEMA CAFFE'

SRL

36402001:

RANCILIO SPA

0083300002:

BRASILIA SPA

456060:

ELETTROBAR

4692: A.T.A. SRL

2101455 12,10X2,70

O-RING NBR /

O-RING NBR

12,10X2,70

07580:

LA SPAZIALE SPA

190010:

MAGISTER

SISTEMA CAFFE'

SRL



2101510 74,60X3,53

O-RING NBR /

O-RING NBR

74,60X3,53

536026700:

LOTUS SPA



2101495 57,15X3,53

O-RING NBR /

O-RING NBR

57,15X3,53

190052:

MAGISTER

SISTEMA CAFFE'

SRL



2101496 58,74X3,53

O-RING NBR /

O-RING NBR

58,74X3,53

190051:

MAGISTER

SISTEMA CAFFE'

SRL



2101489 50,80X3,53

O-RING NBR

SCAMBIATORE

CIMBALI /

O-RING NBR

50,80X3,53

CM099200:

MARENO

INDUSTRIE ALI

SPA

927097:

ELETTROBAR

DIVISIONE DELLA

EUROTEC SRL



2101585 53,34X5,34
O-RING NBR /
O-RING NBR
53,34X5,34
2604100:
MARENO
INDUSTRIE ALI
SPA



2101378 9,19X2,62
O-RING NBR3037 /
O-RING NBR
9,19x2,62
MA2867700:
MARENO
456011:
ELETTROBAR



2101523 117,07X3,5
3 O-RING NBR /
O-RING NBR
117,07X3,53
S000ANA03:
MAZZER LUIGI SRL



2101518 101,2X3,53
O-RING NBR /
O-RING NBR
101,2X3,53
0835351011:
MODULAR SPA
456001:
ELETTROBAR
CF64009303:
CASTEL MAC SPA



2101402 33,00X2,62
O-RING
TROPPOPIENO NBR /
O-RING OVERFLOW
NBR 33,00X2,62
18010033:
NUOVA SIMONELLI
SPA
OR3131:
OMNIWASH



2101590 69,22X5,34
O-RING NBR /
O-RING NBR
69,22X5,34
OR6275:
OMNIWASH
2374:
ARISTARCO SPA



2101411 47,30X2,62
O-RING NBR /
O-RING NBR
47,30X2,62
OR3187:
OMNIWASH SRL -
SOCIETA' A SOCIO
UNICO



2101017 OR
RESISTENZA BOILER
62P /
BOILER HEATING
ELEMENT O RING 62P
ORRB3F:
OMNIWASH SRL -
SOCIETA' A SOCIO
UNICO

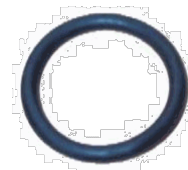

2101383 13,10X2,62
O-RING NBR /
O-RING NBR
13,10X2,62
OR117:
OMNIWASH SRL -
200806:
COMENDA ALI SPA



2101311 9,25X1,78
O-RING GRUPPO NBR
/
O-RING GROUP NBR
9,25X1,78
36402003:
RANCILIO SPA
456019:**ELETTROBA**
R
*: **MBM**



2101316 15,60X1,78
O-RING NBR /
O-RING NBR
15,60X1,78
36401008:
RANCILIO SPA



2101382 12,37X2,62
O-RING NBR /
O-RING NBR
12,37X2,62
36405002:
RANCILIO SPA



2101004 GUARNIZI
ONE LIVELLO
RANCILIO /
LEVEL EXAGONAL
OR RANCILIO
36103002:
RANCILIO SPA

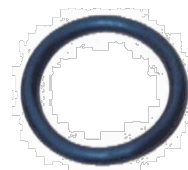

2101793 O RING /
O RING
64004110:
SCOTSMAN DIV.
FRIMONT SPA



2101467 23,40X3,53
O-RING NBR /
O-RING NBR
23,40X3,53
64013400:
SCOTSMAN DIV.
FRIMONT SPA
PR75505: FABA SRL



2101487 49,20X3,53
O-RING NBR /
O-RING NBR
49,20X3,53
64004118:
SCOTSMAN
*:MBM
456061:
ELETTROBAR



2101388 17,13X2,62
O-RING NBR /
O-RING NBR
17,13X2,62
64008100:
SCOTSMAN
33798:
HOONVED - ALI
SPA
9010005:
GRUPPO CIMBALI
DW13007:
DIHR-ALI SPA
OR122:
OMNIWASH SRL -
200819:
COMENDA ALI SPA



2101795 O RING /
O RING
64004113:
SCOTSMAN DIV.
FRIMONT SPA



2101488 50,40X3,53
O-RING NBR /
O-RING NBR
50,40X3,53
0108055:
SILKO ALI SPA
808054:
EMMEPI
862051:
OFFCAR.
6090144: GIORIK
SPA



2101492 53,97X3,53
O-RING NBR /
O-RING NBR
53,97X3,53
904395:
SILANOS SRL
200842:
COMENDA ALI SPA



2101833 O-RING
VMQ70 GIALLO FDA
17,16X1,78 /
O-RING YELLOW
VMQ70 FDA
17,16X1,78
*: SPINEL SRL



2101834 O-RING
VMQ70 GIALLO FDA
9,25X1,78 /
O-RING YELLOW
VMQ70 FDA 9,25x1,78
*: SPINEL SRL



2101835 O-RING
VMQ70 FDA
40,65X5,34 GIALLO /
O-RING YELLOW
VMQ70 FDA
40,65X5,34
*: SPINEL SRL



2101785 OR NERO
8X2 MM ALBERO
CENT.(SIS.
MAGNETICO) /
O-RING 8X2 MM
1002803217:
UGOLINI SPA



2101418 58,42X2,62
O-RING NBR /
O-RING NBR
58,42X2,62
1002802804:
UGOLINI SPA
047462:
ELECTROLUX
200852:
COMENDA ALI SPA



2101379 9,92X2,62
O-RING RESISTENZA
VASCA LT110 NBR
/ O-RING TANK
ELEMENT LT110 NBR
9,92X2,62
1568:
UNIVER-BAR SRL
DW13003: DIHR-ALI
SPA
36404016:
RANCILIO SPA
904391:
SILANOS SRL
200810:
COMENDA ALI SPA
*: MBM
OR112:
OMNIWASH SRL -
SOCIETA' A SOCIO
UNICO



2101007 GUARN.
RESISTENZA VASCA
IME /
TANK HEATING
ELEMENT O RING
IME
6181226T:
OMNIWASH SRL -
SOCIETA' A SOCIO
UNICO

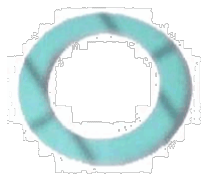

2101008 OR
RESISTENZA BOILER
IME /
BOILER HEATING
ELEMENT O RING
IME
642303S:
OMNIWASH SRL -
SOCIETA' A SOCIO
UNICO



2101858 GUARNIZI
ONE OR 4325 /
SEAL OR 4325
N20987:
BREMA ICE
MAKERS SPA



2101210 GUARNIZI
ONE OR PER TROPPO
PIENO /
O-RING
20688:
BREMA ICE MAKERS
SPA



2101475 34,52X3,53
O-RING NBR /
O-RING NBR
34,52X3,53
027301:
ELECTROLUX
PROFESSIONAL
S.P.A.
200814:
COMENDA ALI SPA
CF64009302:
CASTEL MAC SPA



2101097 OR
RUBINETTO /
OR COCK GBG
SL300000118:
GBG ALI SPA



2101025 OR 177
MISS /
O RING 177 MISS
36405001:
RANCILIO SPA



2101807 GUARN.O
R FANGIA CALDAIA /
O-RING
36404114:
RANCILIO SPA



2101764 GUARNIZI
ONE 42,86X3,53
SILICONE /
O-RING 42,86X3,53
SILICONE



2101851 R10
ANELLO OR
12,10X2,70 SILICONE
ROSSO /
R10 O-RING 12,10 X2,
70 RED SILICONE



2101817 GUARNIZI
ONE OR TAMPONE
AMB RL 6,5 /
O-RING AMB RL 6,5



1116001 PORTAFILT
RO ALETTA BASSA /
LOW TONGUE FILTER-
HOLDER
1116001:
S.V. ITALIA SRL
1116001: MAGISTER
1116001:
FIORENZATO SRL
1116001: WEGA SRL



A= 3126001,B=3126006,
C=3126002,D=3126007,
E= 1116006, F= 1116007

1116014 CORPO
PORTAFILTRO
RE/LE/DE /
FILTER-HOLDER
BODY RE/LE/DE
20112011:
RANCILIO SPA



A= 3108017,B=3108105,
C= 3108106,D=3108104,
E= 1116006, F= 1116012,
G= 1116007,H=3126001,
I= 3126002

1116019 PORTAFILT
RO COMP. RANCILIO
S/B / COMPLETE
FILTER-HOLDER
RANCILIO S/M



1116010 PORTAFILT
RO BETSY NERO
RANCILIO /
BLACK FILTER-
HOLDER BETSY
RANCILIO
10070101:
RANCILIO SPA



1116072 PORTAFILT
RO 2 DOSI LINEA
CASA 08 /
FILTERHOLDER 2
DOSES HOME LINE 08
10070108:
RANCILIO SPA



1116008 PORTAFILT
RO RANCILIO 1 DOSE
OR / OR. 1 DOSE
FILTER-HOLDER
RANCILIO
10071110:
RANCILIO SPA



1116009 PORTAFILT
RO RANCILIO 2 DOSI
OR /
OR. 2 DOSES FILTER-
HOLDER RANCILIO
10071120:
RANCILIO SPA



1116013 PORTAFILT
RO MISS COMPLETO /
COMPLETE FILTER-
HOLDER MISS
10070100:
RANCILIO SPA



1116079 PORTAFILT
RO LEGGERO ALETTA
6mm / M12 /
LIGHT FILTER
HOLDER FLIPPERS
6mm / M12



HANBLE=3108537

1116075 PORTAFILT
RO ALETTA 6mm / M12
/
FILTER HOLDER
FLIPPERS 6mm / M12



HANDLE=3108537

1116057 CORPO
PORTAFILTRO
CROMATO ALETTA
BASSA /
FILTERHOLDER BODY



1116058 PORTAFILT
RO COMPLETO
ALETTA BASSA /
COMPLETE LOW-
TONGUE
FILTERHOLDER



1116002 PORTAFILT
RO ALETTA ALTA /
HIGH TONGUE
FILTER-HOLDER

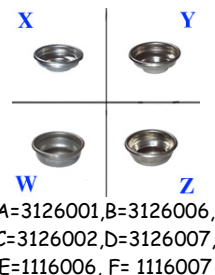

1116039 PORTAFILT
RO FAEMA M16 /
FILTER-HODER
FAEMA M16

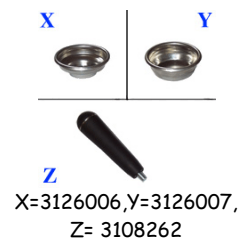

1116040 PORTAFILT
RO FAEMA COMPLETO
OR S/B /
COMPLETE FILTER-
HOLDER FAEMA OR.

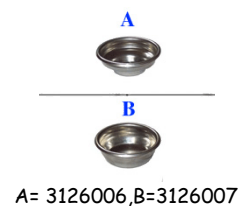

1116081 PORTAFILT
RO LEGGERO ALETTA
6,3 mm / M12 /
FILTER HOLDER
LIGHT FLIPPERS 6.3
mm / M12



HANDLE=3108537

1116083 PORTAFILT
RO LEGGERO ALETTA
7mm / M12 /
LIGHT FILTER
HOLDER FLIPPERS
7mm / M12



HANDLE=3108537

1116077 PORTAFILT
RO ALETTA 7mm / M12
/ FILTER HOLDER
FLIPPERS 7mm / M12



HANDLE=3108537

1116016 CORPO
PORTAF.
BRASILIA/ASTORIA/BE
ZZERA /
FILTER-HOLDER
BODY
BRASILIA/ASTORIA/BE
ZZERA



A= 1116006, B=1116007,
C=3126006,D=3126007,
E= 3108003

1116016:
CMA MACCHINE PER
CAFFE' SRL
1116016:
BRASILIA SPA

1116043 CORPO
PORTAFILTRO
CARIMALI /
FILTER HOLDER
CARIMALI



A= 1116006, B=1116007,
C= 3126013,D=3126014,
E= 3108002

1116004 CORPO
PORTAFILTRO
CIMBALI T.O. /
FILTER-HOLDER
BODY CIMBALI T.O.



A= 1116020, B= 1116021,
C= 1116022, D=3126013,
E= 3126014,F= 3108002

1116073 PORTAFILT
RO CMBL ALETTE
7mm /
FILTER HOLDER CMBL
7mm FLIPPERS



KNOB=3108536

1116025 CORPO
PORTAFILTRO
CIMBALI 3/8"
CROMATO /
"CHROMIUM PLATED
FILTER-HOLDER
BODY CIMBALI 3/8"" "



A= 1116006, B=1116007,
C= 3126013,D=3126014,
E= 3108002

1116033 PORTAFILT
RO CIMBALI M16X1
CROMATO T.O. /
FILTER-HOLDER
CIMBALI M16X1 T.O.



A= 1116048, B= 1116051,
C= 3126013,D=3126014,
E= 3108002

1116098 CORPO
PORTAFILTRO
CIMBALI M16X1
ORGNL /
FILTER HOLDER
CIMBALI M16X1
ORGNL



=1116097

1116018 PORTAFILT
RO GAGGIA /
FILTER-HOLDER
GAGGIA



1116099 PORTAFILT
RO COMPLETO 2011 /
FILTER HOLDER 2011
10792:

LA SPAZIALE SPA



A= 1116017, B= 1116023,
C= 3126045,D=3126008

1116055 PORTAF. 1
DOSE+MANOP. /
FILTER-HOLDER 1
DOSE+KNOB
210029:

MAGISTER SISTEMA
CAFFE' SRL



1116036 CORPO
PORTAFILTRO BAR
CROM. NUOVA
SIMONELLI+MANOPO
LA COMP. /
FILTER-HOLDER
BODY NUOVA
SIMONELLI + KNOB
98005024:
NUOVA SIMONELLI



1116044 CORPO
PORTAFILTRO
PAVONI /
FILTER HOLDER
PAVONI



A= 1116006, B=1116007,
C= 3126013,D=3126014,
E= 3108003

1116015 CORPO
PORTAFILTRO SAN
MARCO /
FILTER-HOLDER
BODY SAN MARCO



A= 1116006, B=1116007,
C= 3126011, D=3126017,
E= 3108189

1116005 CORPO
PORTAFILTRO
SPAZIALE /
FILTER-HOLDER
BODY SPAZIALE



A= 1116017, B= 1116023,
C=3126045,D=3126008,
E=3108003

1116068 PORTAFILT
RO WEGA 1 DOSE
(D52) /
FILTERHOLDER WEGA
1 DOSE (D52)
WY27311056:
WEGA MACCHINE
PER CAFFE' SRL



1116069 PORTAFILT
RO WEGA 2 DOS1 (D52)
/
FILTERHOLDER WEGA
2 DOSES (D52)
WY27311057:
WEGA MACCHINE
PER CAFFE' SRL



1116067 CORPO
PORTAFILTRO WEGA /
FILTER-HOLDER
BODY WEGA
WY27311011:
WEGA SRL



A= 3108452,
B=3108453, C= 1116006,
X= 1116007,Y=3126006,
Z=3126007

1116020 BECCUCCIO
CIMBALI 1 DOSE /
1 DOSE SPOUT
CIMBALI



1116021 BECCUCCIO
CIMBALI 2 DOSI /
2 DOSES SPOUT
CIMBALI



1116022 VITE
BECCUCCIO CIMBALI
OR. INOX /
OR. INOX SPOUT
SCREW CIMBALI



1116006 BECCUCCIO
1 DOSE /
1 DOSE SPOUT



1116070 BECCUCCIO
1 DOSE APERTO 3/8" /
SPOUT 1 DOSE 3/8"



1116017 BECCUCCIO
SPAZIALE 1 DOSE /
1 DOSE SPOUT
SPAZIALE
00656:
LA SPAZIALE SPA



1116012 BECCUCCIO

1 DOSE ORIG.
RANCILIO /
OR. 1 DOSE SPOUT
RANCILIO

21102513EX:
RANCILIO SPA
21102511EX:
RANCILIO SPA
21102601:
RANCILIO SPA



1116007 BECCUCCIO

DUE DOSI /
2 DOSES SPOUT

10707001:
RANCILIO SPA



1116051 BECCUCCIO

2 VIE S/COPERTURA
16X1 /
2 DOSES SPOUT



1116023 BECCUCCIO

SPAZIALE 2 DOSI /
2 DOSES SPOUT
SPAZIALE

00654:
LA SPAZIALE SPA



1116054 BECCUCCIO

2 DOSI SPAZIALE 3/8" /
"2 DOSE SPOUT
SPAZIALE 3/8" ""



1116048 BECCUCCIO

1 DOSE M16X1 /
1 DOSE SPOUT M16X1



1116066 BECCUCCIO

DA 1 VIA LUNGO M16 /
SPOUT 1 DOSE M16



1116097 BECCUCCIO

2 VIE CIMBALI M16X1 /
2 WAY SPOUT
CIMBALI M16X1



=1116098

1116071 BECCUCCIO

1 VIA CECILIA /
SPOUT 1 DOSE
CECILIA

M23A:
LA PICCOLA S.A.S.



1116061 CORPO

PORTAFILTRO
MACCHINA A CIALDE
/
FILTER-HOLDER
BODY FOR POD
COFFEE MACHINE



1116062 PORTAFILT

RO MACCHINA A
CIALDE C/MANOPOLA
/
POD FILTERHOLDER
WITH KNOB



1116080 PORTAFILT

RO LEGGERO ALETTA
6mm / M12 SENZA
FONDO /
LIGHT FILTER
HOLDER FLIPPERS
6mm / M12 WITHOUT
FUND



HANDLE=3108537

1116076 PORTAFILT

RO ALETTA 6mm / M12
SENZA FONDO /
FILTER HOLDER
FLIPPERS 6mm / M12
WITHOUT FUND



HANDLE=3108537

1116082 PORTAFILT

RO LEGGERO ALETTA
6.3 mm / M12 SENZA
FONDO /
FILTER HOLDER
LIGHT FLIPPERS 6.3
mm / M12 WITHOUT
FUND



HANDLE=3108537

1116084 PORTAFILT

RO LEGGERO ALETTA
7mm / M12 SENZA
FONDO /
LIGHT FILTER
HOLDER FLIPPERS
7mm / M12 WITHOUT
FUND



FILTER=3126340,
FILTER=3126341,
FILTER=3126342,
HANDLE=3108537

1116078 PORTAFILT
RO ALETTA 7mm / M12
SENZA FONDO /
FILTER HOLDER
FLIPPERS 7mm / M12
WITHOUT FUND



HANDLE=3108537

1116074 PORTAFILT
RO CMBL ALETTE
7mm M10 SENZA
FONDO /
FILTER HOLDER CMBL
FLIPPERS 7mm M10
WITHOUT FUND



FILTER=3126243,
KNOB=3108536

1116087 CORPO
PORTAFILTRO SAN
MARCO S/FONDO
CROMATO M10 /
FILTER HOLDER SAN
MARCO WITHOUT
FUND



FILTER=3126344,
HANDLE=3108002

1116088 CORPO
PORTAFILTRO
SPAZIALE S/FON
DO CROMATO M12 /
FILTER HOLDER
SPAZIALE M12
WITHOUT FUND



FILTER=3126345,
HANDLE=3108537

1116094 PORTAFILT
RO CAPSULA
LEGGERO CROMATO
RANCILIO /
FILTER HOLDER FOR
CAPSULE - RANCILIO-
(LIGHT)



1116089 PORTAFILT
RO CAPSULA
CROMATO RANCILIO /
FILTER HOLDER FOR
CAPSULE - RANCILIO-



1116096 PORTAFILT
RO LEGGERO
CROMATO ALETTA
6,3MM /
FILTER HOLDER FOR
CAPSULE - FLIPPERS
6.3 mm- (LIGHT)



HANDLE=3108537

1116095 PORTAFILTRO
CAPSULA LEGGERO
CROMATO FAEMA /
FILTER HOLDER FOR
CAPSULE - FAEMA -
(LIGHT)



1116090 PORTAFILT
RO CAPSULA
CROMATO FAEMA /
FILTER HOLDER FOR
CAPSULE -FAEMA -



1116091 PORTAFILT
RO CAPSULA
CROMATO CIMBALI /
FILTER HOLDER FOR
CAPSULE - CIMBALI



1116092 PORTAFILT
RO CAPSULA
CROMATO SAN
MARCO /
FILTER HOLDER FOR
CAPSULE - SAM
MARCO-



1116093 PORTAFILT
RO CAPSULA
CROMATO LA
SPAZIALE /
FILTER HOLDER FOR
CAPSULE - SPAZIALE-



1116032 KIT
PROVACOMPRESSIONE
E O-V /
KIT TO MESURE PUMP
PRESSURE O-V



PORTAFILTRI CAPSULA /
FILTER HOLDERS FOR CAPSULE

CODICE S&P S&P CODE	DESCRIZIONE DESCRIPTION	ADATTABILITA' ADAPTABILITY	
1116089	PORTAFILTRO CAPSULA CROMATO FILTER HOLDER FOR CAPSULE	RANCILIO	
1116094	PORTAFILTRO CAPSULA LEGGERO CROMATO FILTER HOLDER (LIGHT) FOR CAPSULE	RANCILIO	
1116096	PORTAFILTRO LEGGERO CROMATO ALETTA 6,3MM FILTER HOLDER FOR CAPSULE (LIGHT) – FLIPPERS 6,3MM	RANCILIO FAEMA	
1116090	PORTAFILTRO CAPSULA CROMATO FILTER HOLDER FOR CAPSULE	FAEMA	

CODICE S&P S&P CODE	DESCRIZIONE DESCRIPTION	ADATTABILITA' ADAPTABILITY	
1116095	PORTAFILTRO CAPSULA LEGGERO CROMATO FILTER HOLDER (LIGHT) FOR CAPSULE	FAEMA	
1116091	PORTAFILTRO CAPSULA CROMATO FILTER HOLDER FOR CAPSULE	CIMBALI	
1116092	PORTAFILTRO CAPSULA CROMATO FILTER HOLDER FOR CAPSULE	SAN MARCO	
1116093	PORTAFILTRO CAPSULA CROMATO FILTER HOLDER FOR CAPSULE	LA SPAZIALE	

3108236 MANOPOLA
INTERRUTTORE
ROTATIVO PERNO
QUADRO /
SWITCH KNOB HF 32
CB

GIRRAROSTI
PLANTERI

ELETRICI: CB SRL
MANOPOLA INT ROT:
MAZZER LUIGI SPA

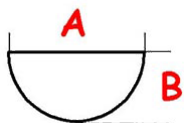

A= 5 mm, B= 5 mm

3108082 MANOPOLA
RUBINETTO H2O
ARGENTA /
KNOB WATER H2O
ARGENTA

15264:

CMA MACCHINE PER
CAFFE' SRL

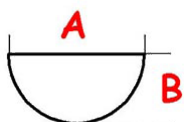

A= 10 mm, B= 10 mm

3108493 MANOPOLA
RUBINETTO VAPORE
FAEMA E98
PRESIDENT /
KNOB FOR STEAM TAP
FAEMA E98

3529134824: FAEMA

495764000: FAEMA



3108418 LEVA
RUBINETTO DX E/91 /
LEVER FOR TAP E/91
RIGHT

911563000: FAEMA



3108368 LEVA
RUBINETTO SX E/91 /
LEVER FOR TAP E/91
LEFT

911564010: FAEMA

911564000: FAEMA



3108478 MANOPOLA
LEVA GR. E/61 /
LEVER GROUP KNOB
E/61

4741135910: FAEMA



3108437 VOLANTINO
ACQUA GRIMAC U.T. /
KNOB WATER GRIMAC
U.T.



3108515 Volantino
Acqua/Vapore Grimac /
KNOB Water / Steam
Grimac



3108502 Volantino
Vapore Grimac U.T.
Cromato /
Hand wheel Steam Grimac
U.T. Chrome-plated



3108516 Tappo Per
Volantino Vapore -
Grimac - (Gocce) /
Cap Flyer Steam - Grimac
- (Drops)



3108480 POMELLO
INFERIORE PER LEVA
TERRY FILETTATO M8
/

KNOB FOR LEVER
GROUP TERRY
THREADED M8



3108324 VOLANTINO
RUBINETTO VAPORE
M28 /
STEAM TAP KNOB
M28

435713000:

GRUPPO CIMBALI SPA



3108489 MANOPOLA
VAPORE/ACQUA
CECILIA /
STEAM/WATER KNOB
P132:

LA PICCOLA S.A.S.



3108486 MANOPOLA
VAPORE S3 /
STEAM TAP KNOB S3
06037:

LA SPAZIALE SPA



3108487 MANOPOLA
EROGAZIONE ACQUA
S3 /
WATER TAP KNOB
06038:

LA SPAZIALE SPA



3108417 POMELLO
M4 RUBINETTO
SPAZIALE /
KNOB M4 TAP -LA
SPAZIALE-
08499:
LA SPAZIALE SPA



3108267 MANOPOLA
RUB. VAPORE /
STEAM COCK KNOB
030020:
MAGISTER SISTEMA
CAFFE' SRL



3108293 MANOPOLA
RUB. VAP. /
STEAM COCK KNOB
030136:
MAGISTER SISTEMA
CAFFE' SRL



3108460 POMOLO
COM. P. A. /
KNOB P.A.
100020:
MAGISTER SISTEMA
CAFFE' SRL



3108520 MANOPOLA
RUBINETTO /
COCK KNOB
40500002:
NUOVA SIMONELLI
SPA



3108161 MANOPOLA
RUB. VAPORE SX /
LEFT STEAM COCK
KNOB
05000039:
NUOVA SIMONELLI
SPA



3108162 MANOPOLA
RUB. VAPORE DX /
RIGHT STEAM COCK
KNOB
05000040:
NUOVA SIMONELLI
SPA



3108163 MANOPOLA
RUBINETTO VAPORE
PROGRAM. /
PROGRAM. STEAM
COCK KNOB
05000022:
NUOVA SIMONELLI
SPA



3108608 "ASSIEME
MANOPOLA VAPORE
""2004"" /
STEAM KNOB
ASSEMBLY "2004"
98006022:
NUOVA SIMONELLI
SPA



3108004 VOLANTINO
VAPORE RANCILIO /
STEAM HAND-WHEEL
RANCILIO
10060152:
RANCILIO SPA



3108100 VOLANTINO
VAPORE EPOCA COMP.
/
STEAM KNOB EPOCA
10060175:
RANCILIO SPA



3108040 VOLANTINO
SCALDATAZZE /
CUPS-WARMER HAND-
WHEEL
10060172:
RANCILIO SPA



3108303 VOLANTINO
VAPORE C10 CON
SERIGRAFIA /
STEAM KNOB C10
WITH SERIGRAPHY
10705087:
RANCILIO SPA



3108401 ASSIEME
MANOPOLA VAPORE /
STEAM KNOB
10060183:
RANCILIO SPA



3108400 MANOPOLA
CLEVER ASSEMBLATA
/
CLEVER KNOB
ASSEMBLY
10060181:
RANCILIO SPA



3108039 VOLANTINO
RUBINETTO ACQUA /
WATER COCK HAND-
WHEEL
10060162:
RANCILIO SPA



3108101 VOLANTINO
ACQUA EPOCA
COMPL. /
WATER HAND-WHEEL
EPOCA
10060176: RANCILIO
SPA



3108102 MANOPOLA
VAPORE MILLENIUM /
STEAM KNOB
MILLENIUM
38123565:
RANCILIO SPA
10060177:
RANCILIO SPA



3108508 TAPPO
MANOPOLA VAPORE
ROYAL /
KNOB CAP FOR STEAM
COCK ROYAL CBC



3108510 TAPPO
MANOPOLA ACQUA
CALDA ROYAL /
KNOB CAP FOR HOT
WATER COCK ROYAL
CBC



3108507 MANOPOLA
RUBINETTO VAPORE
ROYAL /
STEAM COCK KNOB
CBC ROYAL



3108509 MANOPOLA
RUBINETTO ACQUA
CALDA /
HOT WATER TAP
KNOB



knob=3108510

3108278 MANOPOLA
COMANDO
GR.RE/C10P. /
KNOB GR.RE/C10P.
38123860:
RANCILIO SPA



3108513 ASS.MANOP
.RUBIN.ACQUA
VAPORE /
COCK KNOB HOT
WATER / STEAM



3108492 IMPUGNAT
URA PER LEVA
COMANDO /
KNOB



3108483 IMPUGNAT
URA P 10 MA /
FILTER HOLDER KNOB
P 10 MA



3108189 MANOPOLA
PORTAFILTRO TF M10 /
FILTER-HOLDER KNOB
TF M10



=M10

3108536 MANOPOLA
PORTAFILTRO CMBL
M10 /
HANDLE FILTER
HOLDER CMBL M10



=M10

3108002 MANOPOLA
PORTAFILTRO M10MA
/
FILTER-HOLDER
HANDLE M10



=M10

3108003 MANOPOLA
PORTAFILTRO M12MA
/
FILTER-HOLDER
HANDLE M12



=M12

3108537 MANOPOLA
PORTAFILTRO
SATINATA C
SCANALATURE M12
+TAPPO /
FILTER HOLDER KNOB
SATIN M12 + CAP



=M12

3108017 MANOPOLA
PORTAFILTRO
RANCILIO /
FILTER-HOLDER
HANDLE RANCILIO
38121018:
RANCILIO SPA



=3108106

3108104 TAPPO
MANOPOLA PORTAF.
MILLENNIUM /
FILTERHOLDER KNOB
CAP MILLENNIUM
38123599:
RANCILIO SPA
38123570:
RANCILIO SPA



3108105 MANOPOLA
PORTAFILTRO
MILLENNIUM
/ FILTERHOLDER
KNOB MILLENNIUM
38123569:
RANCILIO SPA



3108106 TAPPO
MANOPOLA
PORTAFILTRO Z11/9 /
FILTER-HOLDER
HANDLE CAP Z11/9
38121032:
RANCILIO SPA



3108370 ASSIEME
TAPPO+LOGO RR
PORTAF.MC -PL- /
FILTER HOLDER
HANDLE CLASSE 10
RANCILIO
10705535:
RANCILIO SPA
10060184:
RANCILIO SPA



3108371 MANOPOLA
PORTAFILTRO
RANCILIO N.T. /
FILTER HOLDER
HANDLE RANCILIO
38123906:
RANCILIO SPA



3108262 MANOPOLA
PORTAFILTRO FAEMA
OO M10 /
FILTER-HOLDER KNOB
FAEMA OO



M10

3108452 MANOPOLA
PORTAFILTRO WEGA /
FILTER HOLDER KNOB
WEGA
WY15263010:
WEGA SRL



3108453 TAPPO
MANOPOLA
PORTAFILTRO WEGA /
CAP FOR FILTER
HOLDER KNOB WEGA
WY15486006:
WEGA SRL



1110022 MANOMETR
O A 2 SCALE X 100 /
DOUBLE SCALE
MANOMETER X 100
0546620008:
BRASILIA SPA



1110026 MANOMETR
O A 2 SCALE
N.S. ESTERO /
DOUBLE SCALE
MANOMETER
0497120008:
BRASILIA SPA



1110015 MANOMETR
O QUADRO DOPPIA
SCALA /
DOUBLE SCALE
MANOMETER
21109:
**CMA MACCHINE PER
CAFFE' SRL**



1110024 MANOMETR
O 0-42ATM 2,5 VAPORE
E/91 /
MANOMETER 0-42ATM
2,5 STEAM E/91
3781133401: FAEMA
3781118740: FAEMA



1110006 MANOMETR
O FAEMA E 61 0/16ATM
/
MANOMETER FAEMA E
61 0/16ATM
GRIO3: FAEMA



1110007 MANOMETR
O FAEMA E61 0/3ATM /
MANOMETER FAEMA
E61 0/3ATM
1110007: FAEMA



1110023 MANOMETR
O FAEMA DOPPIA
SCALA /
DOUBLE SCALE
MANOMETER FAEMA
3781133765:
FAEMA



1110031 "MANOMETR
O POMPA - 52 SCALA 0-
16 BAR ATTACCO -
1/8" "ELE" /
PUMP MANOMETER
D.52MM 0-16 BAR 1/8"
THREAD



1110030 MANOMETR
O DOPPIA SCALA E/64-
66 /
MANOMETER DOUBLE
RANGE E/64-66



1110034 MANOMETR
O GEMM SCALA 0:15
POMPA D.50mm 1/8" /
GEMM PRESSURE
GAUGE - SCALE 0:15
PUMP D.50mm 1/8 "



1110035 MANOMETR
O GEMM CALDAIA 0:3
D.50mm 1/8" /
GEMM BOILER
PRESSURE GAUGE - 0: 3
D.50mm 1/8 "
450009000:
GRUPPO CIMBALI SPA



1110029 MANOMETR
O A UNA SCALA /
MANOMETER
210021:
MAGISTER SISTEMA
CAFFE' SRL



1110017 MANOMETR
O MAGISTER /
MANOMETER Magister
210072:
MAGISTER SISTEMA
CAFFE' SRL



1110018 MANOMETR
O MAGISTER DOPPIA
SCALA /
DOUBLE SCALE
MANOMETER
MAGISTER
210022:
MAGISTER SISTEMA
CAFFE' SRL



1110019 MANOMETR
O POMPA C10 D.44 0-16 /
PUMP MANOMETER
C10 D.44 0-16
35002509:
RANCILIO SPA



1110020 MANOMETR
O CALDAIA C10 D.44 0-
2,5 /
BOILER MANOMETER
C10 44 0-2,5
35002506:
RANCILIO SPA
35002508:
RANCILIO SPA



1110009 MANOMETR
O 0-2.5 RANCILIO /
MANOMETER 0-2.5
RANCILIO
35062501:
RANCILIO SPA



1110005 MANOMETR
O 0-2,5 D.54 S10 /
MANOMETER 0-2,5 D.54
S10
35002504:
RANCILIO SPA



1110002 MANOMETR
O X L4/6/7 RANCILIO
D.40 /
MANOMETER X L4/6/7
RANCILIO
35002503:
RANCILIO SPA



1110001 MANOMETR
O 0-16/0-2,5 RANCILIO /
MANOMETER 0-16/0-2,5
RANCILIO
35162501:
RANCILIO SPA

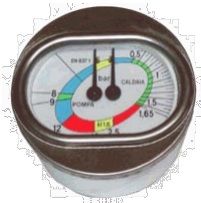

1110004 MANOMETR
O DOPPIA SCALA
S.MARCO /
DOUBLE SCALE
MANOMETER S.MARCO
1110004: SAN MARCO



1110008 MANOMETR
O WEGA DOPPIA
SCALA /
DOUBLE SCALE
MANOMETER WEGA
1110008: WEGA SRL
1110008: VIBIEMME
1110008:
LA PAVONI SPA
1110008:
CMA MACCHINE PER
CAFFE' SRL



1110033 "Manometro
Doppia Scala - 63 Scala 0-
2,5 0-15 Bar Attacco - /
Double Scale Pressure
Gauge 0-15 Bar 0-2.5 - 63
Scale



1110021 MANOMETR
O D.80 SCALA 0-2,5BAR
/
MANOMETER D.80 0-
2,5BAR
441401:
COMENDA ALI SPA



1110014 MANOMETR
O 1 BAR A.PO /
MANOMETER 1 BAR
A.PO
32V0940:
ANGELO PO GRANDI
CUCINE SPA



1110025 MAN. RAD.
BP D.63 60MB /
MANOMETER BP D.63
60MB



1110028 MANOMETR
O D63 0-16BAR BAGNO
GLICERINA 1/4" /
"MANOMETER D63 0-
1BAR 1/4" ""



1110032 MANOMETR
O RADIALE D.63 A
GLIC. /
MANOMETER RADIAL
D.63 GLYCERINE



1110027 MANOMETR
O RADIALE D.80 A
GLIC. /
RADIAL MANOMETER
D.80



1117286 MOLLA
SCATTO DOSE /
SPRING
30: ANFIM SRL



1117786 MOLLA
PRESSINO (op x Stella
Dosatore B+H) /
COFFEE TAMPER
SPRING
23: ANFIM SRL



1117186 MOLLA /
TENSION SPRING
41403:
DITTING
MASCHINEN AG



1117278 MOLLA PER
GIGLEUR FUNGHETTO
(VERSIONE ACQUA) /
GIGLEUR SPRING
(WATER VERSION)



1117752 MOLLA
INFUSORE /
SPRING INFUSER
00484:
LA SPAZIALE SPA



1117116 MOLLA
CROCERA DOSATORE
MCP /
SPRING FOR DOSING
MCP
C0008M108:
MACAP SRL



1117226 MOLLA CPS
3 /
SPRING CPS 3
C0008CPS054:
MACAP SRL



1117252 MOLLA
SGANCIAMENTO CPS /
SPRING RELEASING
CPS
C0008CPS056:
MACAP SRL



1117145 MOLLA PER
SNODO /
COMPRESSION SPRING
160005:
MAGISTER SISTEMA
CAFFE' SRL



1117160 MOLLA
REGOLAZIONE /
REGULATION SPRING
SSJOMOB01AQQEX:
MAZZER LUIGI SPA
S000MOB14QQQ:
MAZZER LUIGI SPA



1117165 MOLLA
PRESSIONE
DOSATURA /
SPRING
S000MOB05QQQ:
MAZZER LUIGI SPA



1117784 MOLLA 6 ST
11,5X8,5X25 /
SPRING ϕ 11.5x25 mm
08000005:
NUOVA SIMONELLI
SPA



1117762 MOLLA
ASTA PRESSACAFFE' /
SPRING AUCTION
tamper'
EBO41: OBEL SRL

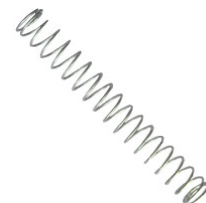

1117789 MOLLA
SALTARELLO /
PEG SPRING
EBO57: OBEL SRL



1117769 MOLLA
PERNO ARRESTO /
SPRING PIN STOPPING
EB05: OBEL SRL



1117756 MOLLA
MANETTINO /
SPRING SMALL
HANDLE
EB055: OBEL SRL



1117247 MOLLA
DADO SNODO
VAPORE ϕ 12x12 mm /
39110038:
RANCILIO SPA



1117141 MOLLA
LIVELLO /
LEVEL SPRING
39110012:
RANCILIO SPA



1117041 MOLLA
SNODO RUBINETTO
RANCILIO /
TAP SPRING RANCILIO
39110025:
RANCILIO SPA



1117222 MOLLA
RUBINETTO ACQUA-
VAPORE /
WATER/STEAM TAP
SPRING
39110035:
RANCILIO SPA



1117054 MOLLA
VALVOLA RITEGNO /
VALVE SPRING
39110060:
RANCILIO SPA



1117002 MOLLA
RUBINETTO/VALVOLA
/
TAP/VALVE SPRING
39110010:
RANCILIO SPA

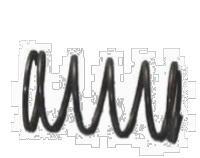

1117792 MOLLA
RUBINETTO RAPIDO
VAPORE ø 14x18 mm /
SPRING QUICK TAP
STEAM ø 14x18 mm
39110036:
RANCILIO SPA



1117003 MOLLA
TAPPO DP/RUBINETTO
/
TAP/DP CAP SPRING
39110030:
RANCILIO SPA

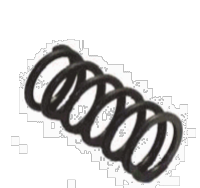

1117005 MOLLA
MAGGIORATA GR.LE
RANCILIO /
SPRING GR.LE
RANCILIO
39120014:
RANCILIO SPA



1117279 MOLLA
VALVOLA RITEGNO /
CHECK VALVE
SPRING
39110065:
RANCILIO SPA



1117136 MOLLA
NASELLO /
SPRING
S000MOB04QQQ:
MAZZER LUIGI SPA



1117138 MOLLA
RITORNO LEVA DI
DOSATURA /
SPRING FOR COFFEE
MACHINE
S000MOB03QQQ:
MAZZER LUIGI SPA



1117276 MOLLA PER
MD ROSSI /
SPRING FOR MD ROSSI



1117778 MOLLA
ACCOPIAMENTO /
SPRING COUPLING
4731133568:
GRUPPO CIMBALI SPA
200063: SAN MARCO



1117781 MOLLA
SINISTRA RITORNO
LEVA DOSATORE /
SPRING RETURN LEFT
LEVER DOSER
4731133582:
GRUPPO CIMBALI SPA



1117790 MOLLA
PULSANTE M2D-M2M /
SPRING BUTTON M2D-
M2M
C248021: MACAP SRL

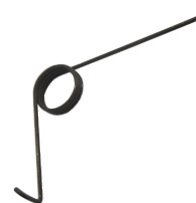

1117197 MOLLA
BOCCHETTA
DROGHERIA /
SPOUT SPRING
S000MOB09QQQ:
MAZZER LUIGI SPA



1117295 MOLLA
CONICA /
CONICAL SPRING



1117742 Molla Inox
Erogazione /
STAINLESS STEEL
SPRING



1117004 MOLLA
FISSAGGIO FILTRO /
FILTER SPRING

1117004:

BRASILIA SPA

25105005:

RANCILIO SPA

1117004: BEZZERA

1117004: FAEMA

1117004:

CMA MACCHINE PER
CAFFE' SRL

27254:

CMA MACCHINE PER
CAFFE' SRL

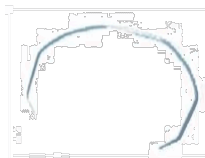

1117749 MOLLA A
LAMINA DOSATORE /
SPRING SHEET
DISPENSER

EB070: OBEL SRL



1117753 MOLLA A
LAMINA /
LAMINATE SPRING

DF70: OBEL SRL



4127183 RUBINETTO
VAPORE M39 (USCITA
VAPORE
PERPENDICOLARE) /
STEAM VALVE M39
(OUTPUT
PERPENDICULAR)



4127188 RUBINETTO
ACQUA CIMBALI /
TAP WATER CIMBALI

485923030:

GRUPPO CIMBALI SPA

485923022ex:

GRUPPO CIMBALI SPA



4127109 RUBINETTO
COMPLETO M20-25-30
CIMBALI /
COMPLETE TAP M20-
25-30

485923012: FAEMA



4127031 CORPO
RUBINETTO /
BODY TAP

53003:

CMA MACCHINE PER
CAFFE' SRL



4127032 ASSIEME
RUBINETTO
ACQUA/VAPORE /
STEAM/WATER TAP

56100R:

CMA MACCHINE PER
CAFFE' SRL

56100:

CMA MACCHINE PER
CAFFE' SRL



4127033 ASSIEME
POMPA ACQUA
ER/AL+AEA /
WATER PUMP KIT
ER/+AL+AEA

61006:

CMA MACCHINE PER
CAFFE' SRL



4127108 RUBINETTO
COMPLETO DUE/E91 /
COMPLETE TAP
DUE/E91

222134605: FAEMA



4127156 RUBINETTO
VAPORE GRIMAC
COMPLETO /
STEAM TAP
COMPLETE GRIMAC



4127157 RUBINETTO
ACQUA GRIMAC
COMPLETO /
WATER TAP
COMPLETE GRIMAC



4127165 RUBINETTO
COMPLETO COMPACT
/
COMPLETE TAP
COMPACT



4127182 RUBINETTO
VAPORE GRIMAC NEW
TEN /
STEAM VALVE NEW
TEN GRIMAC



4127174 NUCLEO
RUBINETTO CECILIA /
CORE TAP CECILIA
P132/1:
LA PICCOLA S.A.S.



4127159 RUBINETTO
COMPLETO 3/8" /
COMPLETE TAP 3/8"
00216:
LA SPAZIALE SPA



4127160 RUBINETTO
ASSEMBLATO S5 / TAP
ASSEMBLY S5
08463:
LA SPAZIALE SPA



4127041 RUBINETTO
MAGISTER A MOLLA
COMP /
COMPLETE SPRING
TAP MAGISTER
900116: MAGISTER

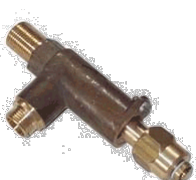

4127186 RUBINETTO
ACQUA-VAPORE
MAGISTER /
TAP HOT WATER AND
STEAM
900166: MAGISTER



4127212 CORPO
RUBINETTO VAPORE x
LANCIA SNOD /
TAP BODY -NUOVA
SIMONELLI
07300354:
NUOVA SIMONELLI



4127196 RUBINETTO
VICTORIA ARDUINO /
TAP VICTORIA
ARDUINO
49900013:
NUOVA SIMONELLI
SPA



4127229 RUBINETTO
VAPORE +LANCIA
INOX 4 FORI -NUOVA
SIMONELLI- /
STEAM TAP WITH
INOX PIPE -NUOVA
SIMONELLI-
98006020:
NUOVA SIMONELLI



4127001 RUBINETTO
VAPORE RANCILIO
ADATTABILE /
STEAM COCK
RANCILIO
ADAPTABLE
10060110:
RANCILIO SPA



4127029 RUBINETTO
ACQUA/VAP.
RANCILIO
/ WATER/STEAM
COCK RANCILIO
10060100:
RANCILIO SPA
10060109:
RANCILIO SPA
10060114:
RANCILIO SPA



gasket=2102490

4127151 RUBINETTO
VAPORE RAPIDO SX /
STEAM RAPID TAP
LEFT SIDE
10060104ex:
RANCILIO SPA
10060101ex:
RANCILIO SPA
10060134:
RANCILIO SPA
10060101:
RANCILIO SPA
10060104:
RANCILIO SPA



GASKET=2102490,
knob=3108400

4127152 RUBINETTO
VAPORE RAPIDO DX /
STEAM RAPID TAP
RIGHT SIDE

10060102ex:

RANCILIO SPA

10060135: RANCILIO

10060106ex:

RANCILIO SPA



GASKET=2102490,
knob=3108400

4127197 RUBINETTO
VAPORE CON SFIATO /
STEAM VALVE WITH
BREATHER

10060103ex:

RANCILIO SPA

10060133:

RANCILIO SPA



4127092 RUBINETTO
VAPORE COMPLETO /
STEAM COCK
COMPLETE SAN
MARCO

400400: SAN MARCO

400150: SAN MARCO



4127187 RUBINETTO
TIZIANO /
TAP "TIZIANO"

SR000077000:

SPINEL SRL



4127220 RUBINETTO
S.V. /
TAP S.V.

SVTMR024:

S.V. ITALIA SRL



A=8mm, B=6mm

4127036 VALVOLA
DOSATORE SCNR CMA
/
DOSING PUMP VALVE
SCNR CMA

56153:

CMA MACCHINE PER
CAFFE' SRL



4116258 COLLETTOR
E COMPLETO /
COMPLETE VALVE

900022:

MAGISTER SISTEMA
CAFFE' SRL



4127144 VALVOLA
RITEGNO /
CHECK VALVE

10060478:

RANCILIO SPA



= 2101379

4127093 VALVOLA
RIT.ESP.EPOCA 1GR. /
CONTAINMENT
VALVE EPOCA 1GR.

10060475EX:

RANCILIO SPA

10060473:

RANCILIO SPA

10060476:

RANCILIO SPA

10060473EX:

RANCILIO SPA



4127044 VALVOLA
RITEGNO ESPANSIONE
Z11 OMICRON /
OMICRON CHECK
VALVE Z11

10060471:

RANCILIO SPA



4127017 VALVOLA
RIT.ESP. 2GR /
CONTAINMENT/EXPA
NSION VALVE 2GR.

10706063:

RANCILIO SPA

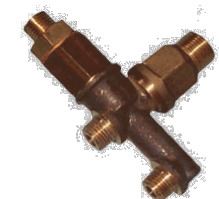

4127134 VALVOLA
ESPANSIONE E/91 /
EXPANSION VALVE
E/91



4127030 VALVOLA
ANTIRITORNO
C/SFERA I. /
ANTI-EDDY VALVE



4127056 VALVOLA
ESPANSIONE REG.
400290 V/12 /
EXPANSION VALVE
400290 V/12

453201:

LA PAVONI SPA



4127075 VALVOLA
SICUREZZA PAVONI /
SAFETY VALVE
PAVONI
395217R:
LA PAVONI SPA



4127055 VALVOLA
DI RITEGNO M3/8-M3/8
/
CONTAINMENT
VALVE M3/8-M3/8
900079:
MAGISTER SISTEMA
CAFFE' SRL



4127145 VALVOLA
ESPANSIONE /
SPREAD VALVE
10060479:
RANCILIO SPA



= 2101379

4127085 VALVOLA
SCARICO FAEMA /
DRAIN VALVE FAEMA
2161136648: FAEMA



4127084 VALVOLA
INFUSIONE FAEMA E61
/
VALVE FAEMA E61
2161136656: FAEMA



4127086 VALVOLA
EROGAZIONE /
OUTPUT VALVE
2161136649: FAEMA



4127173 VALVOLINO
NON RITORNO /
CONTAINMENT
VALVE
00280:
LA SPAZIALE SPA



4127204 KIT
VALVOLINO SFIATO
RUBINETTO VAPORE /
KIT BREATHER VALVE
-STEAM TAP
10705180:
RANCILIO SPA



4127007 VALVOLA
ANTIRISUCCHIO 1/4 /
ANTI-EDDY VALVE
3161134654: FAEMA
56150:
CMA MACCHINE PER
CAFFE' SRL



ring=1125149

4127009 VALVOLA
ANTIRISUCCHIO 3/8 /
ANTI-EDDY VALVE 3/8
10060050:
RANCILIO SPA



4127006 VALVOLA
SICUREZZA ISPEL 3/8
/
SAFETY VALVE ISPEL
97.00148: SAN
MARCO



4127028 VALVOLA
SICUREZZA 3/8 /
SAFETY VALVE 3/8
10060514:
RANCILIO SPA



4127010 VALVOLA
SICUREZZA 1/2 E. /
SAFETY VALVE 1/2 E.
*****:
RANCILIO SPA



4127016 VALVOLA
SICUREZZA 1/2 ISPEL
/
SAFETY VALVE
RANCILIO ISPEL
10060512:
RANCILIO SPA



4127039 RUBINETTO
MINISFERA FF 1/4" D.8
/
"MINIBALL COCK FF
1/4" D.8"



4127008 RUBINETTO
MINISFERA FF3/8 D. 8 /
MINIBALL COCK FF3/8
D.8



4127088 RUBINETTO
MINISFERA FF 1/2 /
MINIBALL COCK FF1/2
1031400300:
MARENO INDUSTRIE
ALI SPA
MA1031400300:
SILKO ALI SPA



4127089 RUBINETTO
MINISFERA M 3/4 F 3/4 /
MINIBALL COCK M 3/4
F3/4



4127014 RUBINETTO
ADDOLCITORE AD /
WATER-SOFTNER
COCK AD



= 2101317

4127123 RUBINETTO
ADDOLCITORE 3/8" F /
"WATER-SOFTNER TAP
3/8" F"



2101378

4127122 RUBINETTO
ADDOLCITORE 3/8"
M(V) /
"WATER-SOFTNER TAP
3/8" M(V)"



2101378

4127142 RUBINETTO
ADDOLCITORE 3/4" M /
WATER SOFTNER TAP
3/4" M



= 2101379

1119001 CAPPUCCHIN
ATORE INOX /
STAINLESS STEEL
CAPPUCCINATORE



1119002 KIT
CAPPUCCINATORE
PLASTICA /
PLASTIC
CAPPUCCINATORE SET



1119003 CAPPUCCHIN
ATORE NUOVO TIPO /
CAPPUCCINATORE
NEW MODEL



1119004 ASSIEME
ATTACCO A 90 /
JOINT ASSEMBLY 90°



1119005 CAPPUCCHIN
ATORE MACCHINE
FAMIGLIA /
CAPPUCCINATORE



1119006 PIPETTA
CASADIO /
FITTING CASADIO
99805500:
CASADIO HBS SRL A
SOCIO UNICO



1119007 MOLLA
PIEGATA CASADIO /
SPRING OF BENDING
CASADIO
998044000:
CASADIO HBS SRL A
SOCIO UNICO



1119008 BASETTA
FISSAGGIO VERTICALE
/ BASE FIXING
VERTICAL
998511000:
CASADIO HBS SRL A
SOCIO UNICO



1118010 TUBO
VAPORE CIMBALI M20
/
STEAM PIPE CIMBALI
M20



1118078 TUBO
VAPORE INOX
CIMBALI /
STAINLESS STEEL
STEAM PIPE CIMBALI



1118090 LANCIA
VAPORE M39 CON
BULBO /
STEAM PIPE



1118086 TUBO
VAPORE COMPLETO
E/91-DUE /
COMPLETE STEAM
PIPE E/91



1118108 TUBO
VAPORE E/61 250MM /
STEAM PIPE E/61
250MM



1118085 TUBO
VAPORE ARIETE
FUTURMAT /
STEAM PIPE ARIETE
FUTURMAT



1118079 TUBO
VAPORE INOX
IBERITAL /
STAINLESS STEEL
STEAM PIPE IBERITAL



1118110 LANCIA
VAPORE CECILIA /
STEAM PIPE CECILIA
P77: LA PICCOLA
S.A.S.



1118104 TUBO
VAPORE INOX
SNODATO S5 /
STAINLESS STEAM
PIPE S5
07833:
LA SPAZIALE SPA



1118107 TUBO
VAPORE SPZL S3-5 /
STEAM PIPE SPZL S3-5



4116502 TUBO
CALDAIA - VAPORE
SX /
STEAM PIPE SX
040030:
MAGISTER SISTEMA
CAFFE' SRL



4116463 TUBO
CALDAIA - LIVELLO
INFERIORE /
STEAM PIPE
040063:
MAGISTER SISTEMA
CAFFE' SRL



1118001 TUBO
VAPORE COMPLETO /
COMPLETE STEAM
PIPE
10706003V:
RANCILIO SPA



1118002 TUBO
VAPORE RANCILIO/
STEAM PIPE RANCILIO
10706018:
RANCILIO SPA
LANVAPSV:
S.V. ITALIA SRL

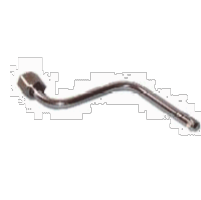

1118065 TUBO
VAPORE INOX
RANCILIO C10/MLN /
STAINLESS STEEL
STEAM PIPE C10/MLN
RANCILIO
10049057:
RANCILIO SPA



1118022 TUBO
VAPORE Z11 INOX /
STAINLESS STEEL
STEAM PIPE Z11
10706003:
RANCILIO SPA



1118005 TUBO
SCARICO VAPORE N.T.
S.MARCO /
STEAM OUTLET PIPE
N.T. S.MARCO



1118015 TUBO
VAPORE WEGA /
STEAM PIPE WEGA
1118015: WEGA SRL



1118075 ASSIEME
TUBO VAPORE INOX /
STAINLESS STEEL
STEAM PIPE



1118076 TUBO
VAPORE INOX /
STAINLESS STEEL
STEAM PIPE



1118074 TUBO
VAPORE /
STEAM PIPE



1118069 TUBO
ACQUA CALDA CF /
HOT WATER PIPE CF



4116569 SPRUZZATO
RE ACQUA CALDA /
HOT WATER OUTLET
900179:
MAGISTER SISTEMA
CAFFE' SRL



1118019 TUBO
ACQUA COMPLETO
MILLENNIUM /
WATER PIPE
MILLENNIUM
10706026:
RANCILIO SPA



1118072 NUOVO
TUBO ACQUA INOX
RNC /
NEW STAINLESS
STEEL WATER PIPE
RNC



1118021 TUBO
ACQUA COMPLETO /
COMPLETE WATER
PIPE
10706009:
RANCILIO SPA



1118073 TUBO
ACQUA CORTO RK /
SHORT WATER PIPE
RK



1118070 TUBO
ACQUA INOX /
STAINLESS STEEL
WATER PIPE



1118071 CANNETTA
VAPORE INOX /
STAINLESS STEEL
STEAM PIPE



1118077 PROTEZION
E TAZZINE SMART
TUBO CR. /
PIPE PROTECTION FOR
CUPS



1118111 TUBO
RACCORDO CALDAIA
RUBINETTO VAPORE
SX /
PIPE FITTING BOILER
STEAM VALVE LEFT

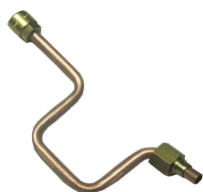

1118112 TUBO
RACCORDO CALDAIA
RUBINETTO VAPORE
DX /
PIPE FITTING BOILER
STEAM VALVE RIGHT



1118063 SPRUZZATO
RE VAP. 3 FORI /
STEAM SPRAY 3
HOLES
100047:
MAGISTER SISTEMA
CAFFE' SRL



1118099 SPRUZZATO
RE VAPORE LG.25 /
SPRAYER STEAM
LG.25
23212033:
RANCILIO SPA



1118082 SPRUZZATO
RE INOX /
STAINLESS STEEL
SPRAYER



1116026 SPRUZZATO
RE VAP.RANCILIO.4F
D11,5H25 CR /
VAPOUR SPRAYER
RANC. 4F D11,5 H25 CR



1118066 GOMMINO
DIAMETRO 7,6 /
STEAM PIPE RUBBER
DIAM. 7,6



1118067 GOMMINO
DIAMETRO 10
ESAGONALE /
STEAM PIPE RUBBER
DIAM. 10



1118068 GOMMINO
DIAMETRO 10
CIRCOLARE /
STEAM PIPE RUBBER
DIAM. 10
36990004:
RANCILIO SPA



1118106 GUAINA
GOMMA PER TUBO
VAPORE SNODATO /
STEAM PIPE RUBBER
08256:
LA SPAZIALE SPA



1118080 LUNETTA
TEFLON PER SNODO /
TEFLON SPRING
GUIDE FOR STEAM
PIPE



1124002 ELETTRO
V.
ECONOMIZZATORE
RUBINO /
ECONIMIZER
SOLENOID VALVE
34040104:
RANCILIO SPA
MAGI:
MAGISTER



BOBINA=1124045

1124205 ELETTRO
VALVOLA PARKER 2
VIE RUB. /
SOLENOID VALVE 2
WAYS



BOBINA=1124180

1124079 ELETTRO
V. ECONOM. EPDM
220V /
ECONOMIZER
SOLENOID VALVE
EPDM 220V



1124001 ELETTRO
V. LUCIFER 3 VIE
220/240 RUBINO /
SOLENOID VALVE
LUCIFER 3 WAYS
220/240

180001:

MAGISTER
SISTEMA CAFFE'
SRL

34040008:

RANCILIO SPA
533795610: FAEMA
18151: CMA



NUCLEO=1124046,
BOBINA=1124045

1124047 ELETTRO
V. LUCIFER
ECONOM. VITON /
SOLENOID VALVE
LUCIFER
ECONOMIZER
VITON



BOBINA=1124045

1124054 ELETTRO
V. PARKER 3 VIE
220/240 /
SOLENOID VALVE
PARKER 3 WAYS
220/240

00628:

LA SPAZIALE SPA



NUCLEO=1124181,
BOBINA=1124180

1124077 ELETTRO
V. ACL 3VIE 230V
EPDM /
SOLENOID VALVE
ACL 3 WAYS 230V
EPDM



1124362 ELETTRO
VALVOLA 3 VIE
220/240 PARKER
R/1,5 TENUTA
RUBINO CORPO
INOX /
SOLENOID VALVE
PARKER 3 WAYS
220/240 R/1,5
STAINLESS STEEL
BODY



BOBINA=1124045

1124016 ELETTRO
VALVOLA 3 VIE 24V
/
SOLENOID VALVE 3
WAYS 24V



BOBINA=1124102

1124171 ELETTRO
VALVOLA LUCIFER
3 V 24V=/
SOLENOID VALVE
LUCIFER 3V 24V



BOBINA=1124169

1124134 ELETTRO
VALVOLA GRUPPO 3
VIE 110V /
SOLENOID VALVE 3
WAYS 110V



BOBINA=1124129

1124185 ELETTRO
VALVOLA PARKER
CON CAVO /
SOLENOID VALVE
PARKER WITH
CABLE



BOBINA=1124156

1124046 NUCLEO
LUCIFER GRUPPO
RUBINO /
SOLENOID
CENTRAL UNIT
LUCIFER



1124181 NUCLEO
PARKER
ELETTROVALVOLA
3 VIE 220/240 /
SOLENOID
CENTRAL UNIT
PARKER 3 WAYS
220/240



BOBINA= 1124180

1124011 ELETTRO
VALVOLA LUCIFER
2 VIE F1/8-F1/8 220V /
SOLENOID VALVE
LUCIFER 2 WAYS
RALS

34040002:

RANCILIO SPA
180015: MAGISTER
533798310: FAEMA
11: LA SPAZIALE



BOBINA=1124045

1124269 ELETTRO
VALVOLA LUCIFER
2 VIE F1/8-F1/8
TENUTA RUBINO /
2 WAYS SOLENOID
VALVE LUCIFER
F1/8-F1/8 RUBY SEAL



1124078 ELETTRO
V. 2 VIE 1/8" 220V
RALS /
2 WAYS SOLENOID
VALVE 1/8" 220V
RALS



1124202 ELETTRICO
VALVOLA G1/8-1/8
DN2 230V-50Hz
EPDM PX 9VA /
SOLENOID VALVE
G1/8-1/8 DN2 230V-
50Hz EPDM PX 9VA



1124329 ELETTRICO
VALVOLA 2 VIE
230V 50Hz 1/8" /
2 WAY SOLENOID
230V 50Hz 1/8"



1124203 ELETTRICO
VALVOLA 3 VIE 3°
VIA G1/8 230V 50Hz
9VA DN1 /
SOLENOID VALVE 3
WAYS G1/8 230V
50Hz 9VA DN1



1124330 ELETTRICO
VALVOLA 3 VIE
230V 50Hz /
3-WAY SOLENOID
230V 50Hz



1124051 ELETTRICO
V.PARKER 2 VIE 1/4 /
SOLENOID VALVE
PARKER 2 WAYS 1/4
533895800: FAEMA
1124051: SAN
MARCO
06478:
LA SPAZIALE SPA



BOBINA=1124180

1124177 ELETTRICO
VALVOLA PARKER
1/4-1/4 3V 230V /
SOLENOID VALVE
PARKER 1/4-1/4
3WAYS 230V



BOBINA=1124180

1124270 ELETTRICO
VALVOLA LUCIFER
F 1/4 - F 1/4 TENUTA
RUBINO /
SOLENOID VALVE
LUCIFER F 1/4- F1/4



BOBINA=1124180

1124090 ELETTRICO
VALVOLA 2 VIE 1/4"
VITON 220 / "
SOLENOID VALVE 2
WAYS 1/4" VITON
220"



1124005 ELETTRICO
V. LUCIFER 1/8 24V
2V / SOLENOID
VALVE PARKER 1/8
24V 2V



BOBINA=1124102

1124013 ELETTRICO
V. ACQUA CALDA
OMIC/STYL / HOT
WATER SOLENOID
VALVE OMIC/STYL
10060486:
RANCILIO SPA



1124014 ELETTRICO
V. RALS COMPL. Z11
/
COMPLETE
SOLENOID VALVE
RALS Z11
*: RANCILIO SPA
*: RANCILIO SPA



1124105 ELETTRICO
VALVOLA ACQUA
CALDA 24V= /
SOLENOID VALVE
RALS 24V/=EPOCA
*: RANCILIO SPA



1124174 ELETTRICO
VALVOLA RALS
24V= /
SOLENOID VALVE
RALS 24V=
10060466:
RANCILIO SPA



1124045 BOBINA
LUCIFER 220/240V
50Hz 9W /
SOLENOID VALVE
COIL LUCIFER
220/240V

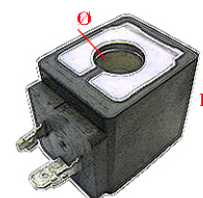

H=37mm, Ø=14,8mm,
DIMENSION=32X43mm

1124180 BOBINA
PARKER
ELETTRICITÀ
220/240V 50-60Hz 9W
/
SOLENOID VALVE
COIL PARKER 3
WAYS 220/240

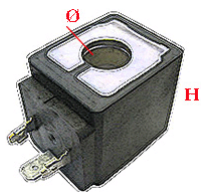

H=33mm, Ø=14,5mm,
DIMENSION=34X43mm

1124102 BOBINA
LUCIFER 24V 50Hz
9W (AC) /
COIL LUCIFER 24V
(AC)

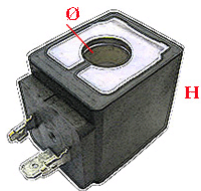

H=37mm, Ø=14,8mm,
DIMENSION=32X43mm

1124169 BOBINA
LUCIFER 24V= 9W
(CC) /
SOLENOID VALVE
COIL LUCIFER 24V=
(CC)

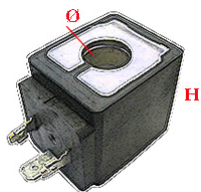

H=37mm, Ø=14,8mm,
DIMENSION=32X43mm

1124187 BOBINA
24V= ZB12 12W /
SOLENOID VALVE
COIL 24V=ZB12

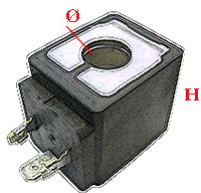

H=33mm, Ø=14,5mm,
DIMENSION=34X43mm

1124139 BOBINA
LUCIFER 12V= 9W /
SOLENOID VALVE
COIL LUCIFER 12V=

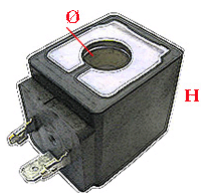

H=37mm, Ø=14,8mm,
DIMENSION=32X43mm

1124129 BOBINA
LUCIFER 110-115V
50Hz 9W /
SOLENOID VALVE
COIL LUCIFER 110V

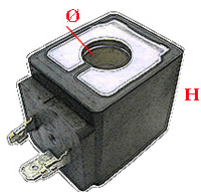

H=37mm, Ø=14,8mm,
DIMENSION=32X43mm

1124156 BOBINA
PARKER YB09 220-
230V 50-60Hz 9W /
COIL PARKER YB09
*: CASTEL MAC SPA

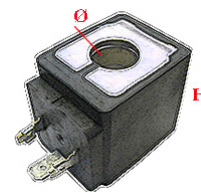

H=31mm, Ø=14,4mm,
DIMENSION=34X41mm

1124162 BOBINA
VALVOLA GAS
CALDO - YB14 220-
230V 50-60Hz 14W /
HOT GAS VALVE
COIL

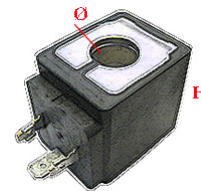

DIMENSION=34X41mm,
H=31mm, Ø=14,4mm,
VALVE=1124233

CMCF62030648:
CASTEL MAC SPA
62030648:
SCOTSMAN ICE
SRL

1124355 KIT
OPERATORE 2/2 VIE
ACQUA 24V T22
(PARKER) /
KIT OPERATOR 2/2
WAY WATER 24V
T22 (PARKER)



34049012:
RANCILIO SPA

1124351 KIT
OPERATORE 24V
MOD.IDRAULICO /
KIT OPERATOR 24V
HYDRAULIC MODEL



69140013:
RANCILIO SPA

1124253 ELETTR.+
RACC.TSC 3 VIE 24V
/
SOLENOID VALVE 3
WAYS 24V



10060481:
RANCILIO SPA

1124352 ECONOMI
ZZATORE 24V /
ECONOMISER 24V



10705756:
RANCILIO SPA

4116596 KIT
STARTER MODULO
IDRAULICO 24V /
STARTER KIT
HYDRAULIC
MODULE 24V



10700299:
RANCILIO SPA

1124339 BLOCCHETTO
ELETTRICO
ELETTRICOVALVOLE
3 VIE 24VDC
CASADIO /
BLOCK 3 WAYS
SOLENOID 24VDC
CASADIO
533900500:
CASADIO HBS SRL
A SOCIO UNICO



1124017 EL.VAL. 2
VIE ACQUA 1/4"
220V /
"WATER SOLENOID
VALVE 2 WAYS 1/4"
220V"



1124022 EL.VAL. 2
VIE 1/4" VAP/ACQUA
24 /
"STEAM/WATER
SOLENOID VALVE 2
WAYS 1/4" 24"



1124024 EL.VAL.
1/4" VAP/ACQUA
220V /
"STEAM/WATER
SOLENOID VALVE
1/4" 220V"



1124018 EL.VAL. 2
VIE 3/8" ACQUA
220V /
"WATER SOLENOID
VALVE 2 WAYS 3/8"
220V"



1124019 EL.VAL.
1/2" ACQUA 220V
50HZ /
"WATER SOLENOID
VALVE 1/2" 220V
50HZ"
120174:
COMENDA ALI SPA
120174:
HOONVED - ALI
SPA



1124041 ELETTRICO
V. 1/2" ACQUA 220V
BG /
"WATER SOLENOID
VALVE 1/2" 220V
BG"



1124085 ELETTRICO
VALVOLA L140
FF1/2" 230V /
"SOLENOID VALVE
L140 FF1/2" 230V"
23140006*:
ELFRAMO SPA



1124023 EL.VAL. 2
VIE 1/2" VAP/ACQUA
24V /
"STEAM/WATER
SOLENOID VALVE 2
WAYS 1/2" 24V"
23140004:
ELFRAMO SPA

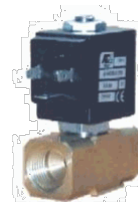

1124026 EL.VAL.
1/2" VAP/ACQUA
220V /
"STEAM/WATER
SOLENOID VALVE
1/2" 220V"



1124108 EL.VAL. 2
VIE 1/2" VAP/ACQUA
220V APERTA /
"STEAM/WATER
SOLENOID VALVE 2
WAYS 1/2" 220V"



1124025 EL.VAL. 2
VIE 1/2" VAP/ACQUA
220V /
"STEAM/WATER
SOLENOID VALVE 2
WAYS 1/2" 220V"
23140006
: ELFRAMO SPA



1124020 EL.VAL.
3/4" ACQUA 220V
50HZ /
"WATER SOLENOID
VALVE 3/4" 220V
50HZ"
120158:
COMENDA ALI SPA



1124341 "ELETTRICO
VALVOLA X
ACQUA NC 3/4"
PRESS.DIFF.0,15/13B
AR" 24V AC /
SOLENOID VALVE
FOR WATER NC 3/4"
".0,15 / 13BAR" 24V
AC



1124021 EL.VAL.
1"ACQUA/GAS 220V
50-60 /
"WATER/GAS
SOLENOID VALVE
1" 220V 50-60"



1124027 EL.VAL. 2
VIE 1/4" GAS 220V /
"GAS SOLENOID
VALVE 2 WAYS 1/4"
220V"



1124028 EL.VAL. 2
VIE 1/2" GAS 220V /
"GAS SOLENOID
VALVE 2 WAYS 1/2"
220V"



1124029 EL.VAL. 2
VIE 3/4" GAS 220V /
"GAS SOLENOID
VALVE 2 WAYS 3/4"
220V"



1124118 ELETTO
V. VAPORE 24V 1/2" /
"STEAM SOLENOID
VALVE 24V 1/2"
120165:
COMENDA ALI SPA



1124121 ELETTO
VALVOLA VAPORE
L145R1Z734AA 1/2"
24V /
"STEAM SOLENOID
VALVE
L145R1Z734AA 1/2"
24V"
120161:
COMENDA ALI SPA



1124254 ELETTO
VALVOLA
COMPL.LAVASTOVI
GLIE /
SOLENOID VALVE
COMPL.
090912: FABAR SRL



1124312 ELETTO
VALVOLA SCARICO
ARIA LINEA 46 /
DRAIN VALVE FOR
AIR LINE 46



1124316 ELETTO
VALVOLA L140
Z610A G1/2F 24V /
SOLENOID VALVE
L140 24V Z610A
G1/2F
120125:
COMENDA ALI SPA



1124307 "ELETTR
OVALVOLA
INDISTR.3/4" " /
"INDUSTRIAL
VALVE 3/4" "
27132:
HOONVED - ALI
SPA



1124049 ELETTO
V. VAPORE 1"1/4 180°
C /
"STEAM SOLENOID
VALVE 1"1/4 180°C"



1124055 BOBINA X
ELETTOVALVOLE
20/E 220V 50Hz /
SOLENOID VALVE
COIL 20/E

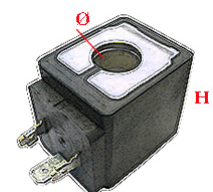

H=39mm, Ø=13,5mm,
DIMENSIONS 30X42mm

1124059 BOBINA X
ELETTOVALVOLA
22/E 220V 50Hz /
SOLENOID VALVE
COIL 22/E

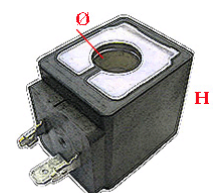
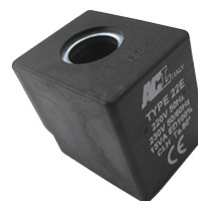

H=39mm, Ø=13,4mm,
DIMENSIONS 30X42mm

1124056 BOBINA X
ELETTOVALVOLA
30/E 230V 50-60Hz /
SOLENOID VALVE
COIL 30/E

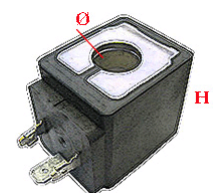

H=31mm, Ø=10,3mm,
DIMENSIONS 22X27mm

1124060 BOBINA X
ELETTROVALVOLA
32/E /
SOLENOID VALVE
COIL 32/E

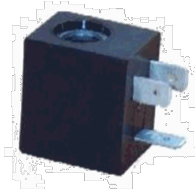

1124061 BOBINA X
ELETTROVALVOLA
40/E 220V 50Hz /
SOLENOID VALVE
COIL 40/E

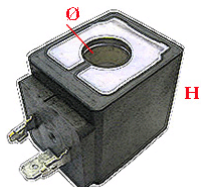
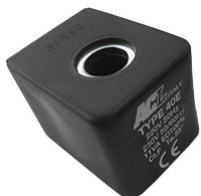

H=30mm, Ø=10,3mm,
DIMENSIONS 30X38mm

1124039 BOBINA
ELETTROVALVOLA
20/B 24V 50HZ /
SOLENOID VALVE
COIL 24V 50HZ

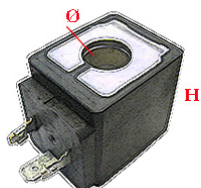
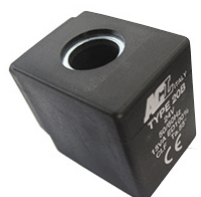

H=39mm, Ø=13,4mm,
DIMENSIONS 30X42mm

1124058 BOBINA X
ELETTROVALVOLA
22/B 24V 50-60Hz /
SOLENOID VALVE
COIL 22/B

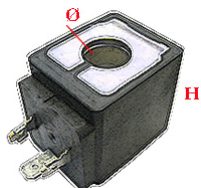
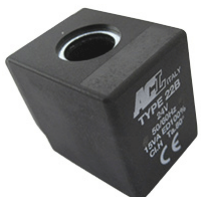

H=39mm, Ø=13,4mm,
DIMENSIONS 30X42mm

1124193 BOBINA
24V 30B /
SOLENOID VALVE
COIL 24V 30B



1124218 BOBINA
TIPO 30/B 24V AC
(ALTERNATA) 50-
60Hz /
SOLENOID VALVE
COIL 30/E 24V DC

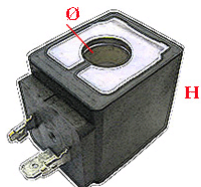
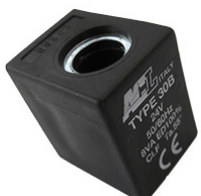

H=31mm, Ø=10,3mm,
DIMENSIONS 22X27mm

1124317 BOBINA
32B 24V AC 50-60Hz /
32B 24V AC COIL

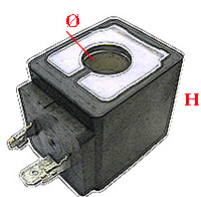

H=31mm, Ø=10,3mm,
DIMENSIONS 22X27mm

1124057 BOBINA X
ELETTROVALVOLA
22I 24V= 10W /
SOLENOID VALVE
COIL 22I

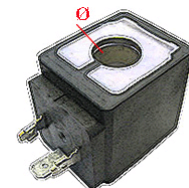
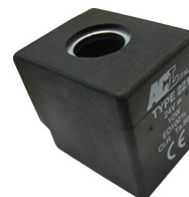

H=39mm, Ø=13,4mm,
DIMENSIONS 30X42mm

1124271 BOBINA X
EV 30I 24V= DC 6,5W
/
SOLENOID VALVE
COIL 24V DC

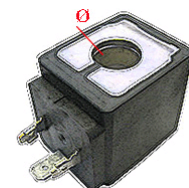

H=31mm, Ø=10,3mm,
DIMENSIONS 22X27mm

1124087 BOBINA
V.48/50-60 E2A
NYLON 20/C /
COIL V48/50-60 E2A
NYLON

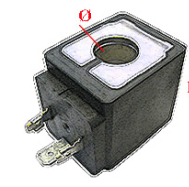

H=39mm, Ø=13,4mm,
DIMENSIONS 30X42mm

1124062 BOBINA X
ELETTROVALVOLA
52/G 380V 50-60Hz /
SOLENOID VALVE
COIL 52/G

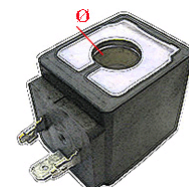

H=39mm, Ø=13,4mm,
DIMENSIONS 36X48mm

1124038 BOBINA
EL. VAL. 380V 50HZ /
SOLENOID VALVE
COIL 380V 50HZ



1124080 CONNETT
ORE RETTANG. X
SERIE 30 /
RECTANGULAR
CONNECTOR FOR
SET 30

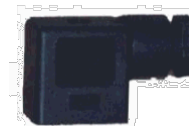

BOBINA=1124093

1124081 CONNETTO
RE QUADRATO X
SERIE 30 /
SQUARE CONNECTOR
FOR SET 30



1113118 PRESSOSTA
TO JAEGER 1/4G 1.7bar
/
PRESSURE SWITCH
JAEGER 1/4G 1.7bar
SR000066000:
SPINEL SRL



1113001 PRESSOSTA
TO SIRAI /
PRESSURE SWITCH
SIRAI

34200110:
RANCILIO SPA
180023:
MAGISTER SISTEMA
CAFFE' SRL



1113068 PRESSOSTA
TO SIRAI
OMOLOGATO UL /
PRESSURE SWITCH
SIRAI UL

1113068:
MAGISTER SISTEMA
CAFFE' SRL



1113017 PRESSOSTA
TO PARKER /
PRESSURE SWITCH
PARKER

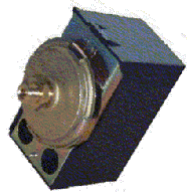

1113109 PRESSOSTA
TO CECILIA /
PRESSURE SWITCH
CECILIA

P30:
LA PICCOLA S.A.S.



1113020 PRESSOSTA
TO 0,5-1,2 -1/4" /
"PRESSURE SWITCH
0,5-1,2 -1/4""



1113046 PRESSOSTA
TO 1/8" GAS 0,9-1,5
BAR UL (pret. 1,2 bar) /
"PRESSURE SWITCH
1/8"" GAS 1-2,5 BAR
UL"

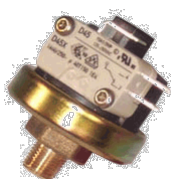

**TERMOSTATI DI SICUREZZA MONOFASE /
SAFETY THERMOSTATS SINGLE PHASE**





CODICE S&P S&P CODE	TEMPERATURA °C TEMPERATURE °C	N. POLI N.POLES	SCHEDA TECNICA DATA SHEET	CAPILLARE RICOPERTO CAPILLARY COVERED	ADATTABILITA' ADAPTABILITY
1106244	108°	4	A=1000mm	NO	STA-GOLOSO4-PIZZA CB- FP-BAKE/CHEF:CB
1106247	108°	4	A=1000mm	NO	FP OLD MODEL:CB
1106135	165°	4	A=500mm	NO	34200093:RANCILIO
1106114	165°	2	A=500mm	NO	34200092:RANCILIO 180039: MAGISTER



**TERMOSTATI DI SICUREZZA TRIFASE /
SAFETY THERMOSTATS THREE PHASES**

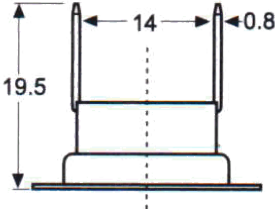
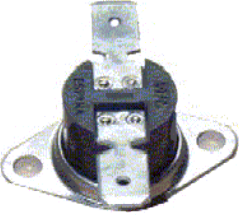
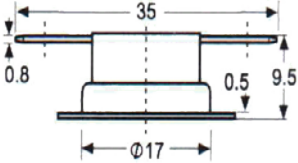

CODICE S&P S&P CODE	TEMPERATURA °C TEMPERATURE °C	N. POLI N.POLES	SCHEDA TECNICA DATA SHEET	CAPILLARE RICOPERTO CAPILLARY COVERED	ADATTABILITA' ADAPTABILITY
1106233	140°	6	A=Ø4X126mm B=900mm	SI - YES	9041033:HEMERSON 984140000:GRUPPO CIMBALI 1037305000:MARENO
1106277	169°	6	A=Ø4X128mm B=900mm	SI - YES	34200095:RANCILIO
1106408	187°		A=Ø4X125mm B=1000mm	SI - YES	34200096:RANCILIO

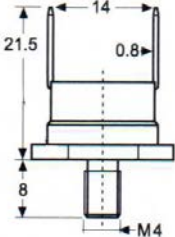
TERMOSTATI A CONTATTO / CONTACT THERMOSTATS

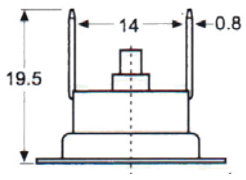
CODICE S&P S&P CODE	TEMPERATURA °C TEMPERATURE °C	SCHEDA TECNICA DATA SHEET	ADATTABILITA' ADAPTABILITY
			
1106237	60°C		LT35-22: ELETTOBAR
1106183	80°C		236048: ELETTOBAR
1106111	90°C		236052: ELETTOBAR
1106148	95°C		34200074: RANCILIO SPA 34200059: RANCILIO SPA
1106316	110°C		34200056: RANCILIO SPA
1106159	115°C		
1106149	130°C		
1106160	140°C		
1106150	155°C		
1106151	160°C		
1106152	165°C		
1106153	170°C		
1106154	175°C		
1106155	180°C		
			
1106289	55°C		L2061: LUXIA SRL
1106047	57°C		907123: SILANOS SRL
1106442	75°C		
1106740	100°C		
1106080	140°C		
			
1106481	95°C		
1106016	100°C		34200074: RANCILIO SPA
1106430	107°C		

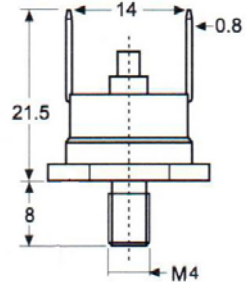
CODICE S&P S&P CODE	TEMPERATURA °C TEMPERATURE °C	SCHEDA TECNICA DATA SHEET	ADATTABILITA' ADAPTABILITY
1106017	135°C		34200075: RANCILIO SPA
1106432	125°C		
1106345	165°C		34200053: RANCILIO SPA
			
1106334	95°C		926189: ELETTOBAR 236047: ELETTOBAR
1106744	100°C		907245: SILANOS SRL
1106364	105°C		0300302: LAMBER
1106182	110°C		236039: ELETTOBAR
1106454	130°C		
			
1106483	145°C		
1106043	165°C		34200058: RANCILIO SPA

1106025 TERMOMETRO DIGITALE -50+260°
/ DIGITAL THERMOMETER 50+260°



1106204 TERMOMETRO PER FORNO / THERMOSTAT FOR OVEN



1106466 TERMOIGROMETRO ELETTRONICO CON MIN/MAX / THERMOIGROMETER



1106467 TERMOIGROMETRO CON SONDA INTERNO/ESTERNO / THERMOIGROMETER WITH INTERNAL/EXTERNAL PROBE



1106218 TERMOMETRO DIGITALE CON SONDA FISSA -50+150 / DIGITAL THERMOMETRE WITH FIXED PROBE -50+150



1106318 TERMOMET
RO DIGITALE CON
SONDA FISSA -
50°C+300°C /
DIGITAL
THERMOMETER WITH
FIXED PROBE -
50°C+300°C



1106131 TERMOMET
RO INFRAROSSI -
18+400° /
INFRA-RED
THERMOMETER -
18+260°





1106075 TERMOMET
RO ABS -40+40 /
ALCOHOL MOPLN
THERMOMETER -40+40







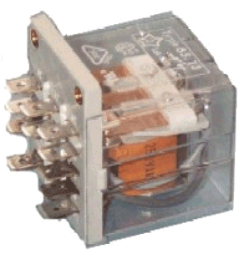
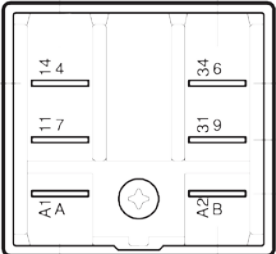
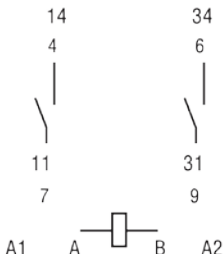
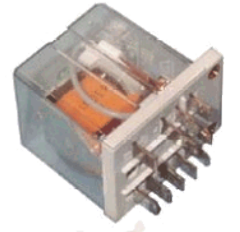
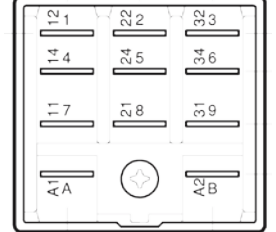
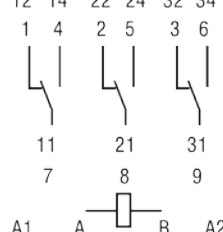
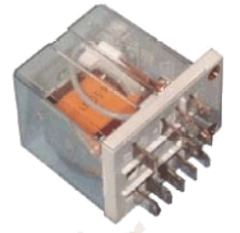
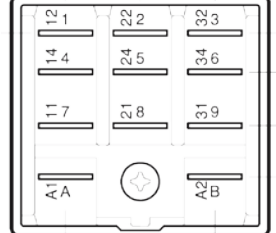
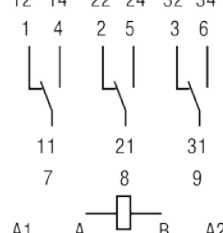

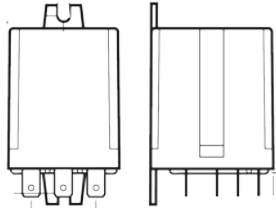
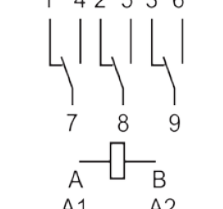

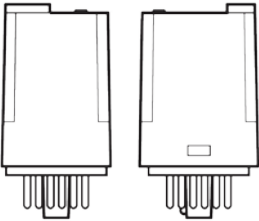
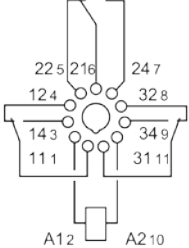
1106076 TERMOMET
RO MOPLN -50+50 /
ALCOHOL ABS
THERMOMETER -40+40

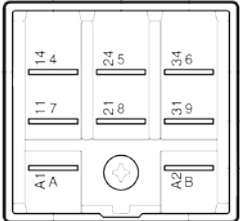
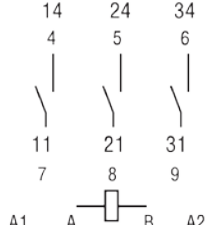

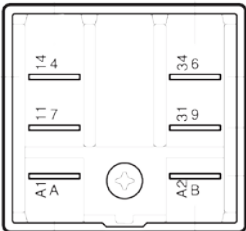
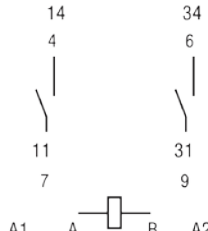
RELE'/RELAYS

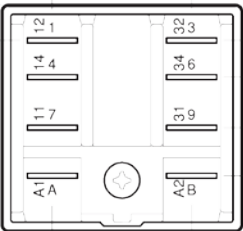
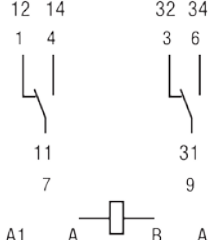
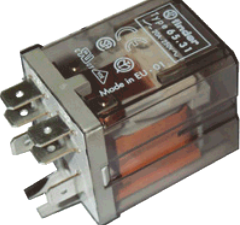
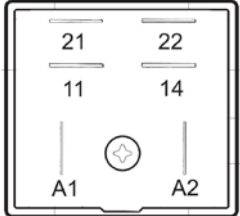
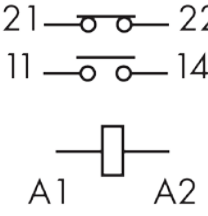
CODICE S&P S&P CODE		CONTATTI CONTACTS	SCHEMA ELETTRICO WIRING DIAGRAM	DESCRIZIONE DESCRIPTION
1109001				RELE' 230 V 16 AMPERE
1109005				RELE' 230 V 16 AMPERE
1109010				RELE' 24 V 16 AMPERE
1109015				RELE' 230V 10 AMPERE

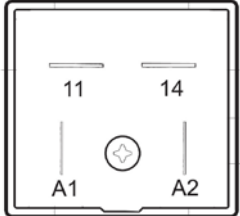
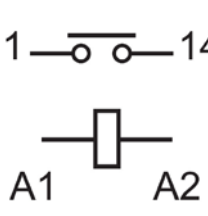
CODICE S&P S&P CODE		CONTATTI CONTACTS	SCHEMA ELETTRICO WIRING DIAGRAM	DESCRIZIONE DESCRIPTION
1109021				RELE' 230V 10 AMPERE
1109024				RELE' 230V 16 AMPERE
1109040				RELE' 230V 16 AMPERE
1109060				RELE' 230V 16 AMPERE
1109099				RELE' 230V 20 AMPERE
1109100				RELE' 230V 30 AMPERE

1109100 RELE' 30A /
RELAY 30A

1LT028: MIGEL S.R.L.

229029:

MBM- EUROTEC SRL -
DIV. COOKING
SERVICE

229029:

ELETTROBAR
DIVISIONE DELLA
EUROTEC SRL

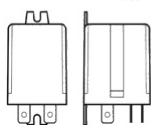
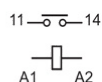

1109040 RELE
FINDER 230V 50/60HZ
GUIDA DIR /
RELAY FINDER 230V
50/60HZ

DW560301:

DIHR-ALI SPA

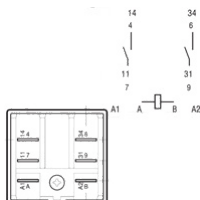

1109001 RELE' 230
16A /
RELAY 230 SILANOS

0301794:

LAMBER DI AFFABA
FRANCESCO & C.

CR0687240:

LAINOX ALI SPA

E229039:

HOBART GmbH

4271: A.T.A. SRL

905474*:

SILANOS SRL

DW16037:

DIHR-ALI SPA

229039:

ELETTROBAR

DIVISIONE DELLA
EUROTEC SRL

34200189:

RANCILIO SPA

CR0687240:

SILKO ALI SPA

4360:

UNIVER-BAR SRL

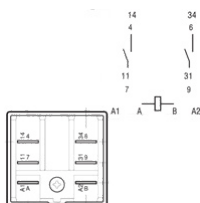

1109060 RELE' DI
POTENZA 16/250 /
RELAY 16/250

929115:

ELETTROBAR

DIVISIONE DELLA
EUROTEC SRL

34200037:

RANCILIO SPA

3222000:

ANGELO PO GRANDI

CUCINE SPA

04200046:

NUOVA SIMONELLI
SPA

DW15620:

DIHR-ALI SPA

9531505700:

GRUPPO CIMBALI SPA

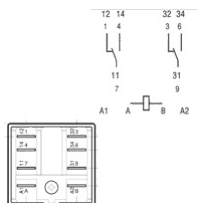

33324:

HOONVED - ALI SPA

EN125: OEM ALI SPA

34312:

HOONVED - ALI SPA

0301745:

LAMBER DI AFFABA
FRANCESCO & C.

25130100:

ELFRAMO SPA

LAR65170100:

LAINOX ALI SPA

LAR65170100:

OLIS DIVISIONE DI

ALI GROUP SPA -

DER1108:

ELETTROBAR

DIVISIONE DELLA

EUROTEC SRL

1109027 RELE'

220/50ATT/FAST.2SCA

MBI 10A /

RELAY 220/50

ATT/FAST.2 CHANGES

10A

229023:

ELETTROBAR

DIVISIONE DELLA
EUROTEC SRL

CM19620107:

SIMAG SPA

RI000761:

EURFRIGOR SRL

RI000761:

EURFRIGOR ICE

MAKERS SRL

CM19620107:

SCOTSMAN ICE SRL

CM19620107/0:

CASTEL MAC SPA

926072:

BRICE ITALIA SRL

CM19620101/0ex:

CASTEL MAC SPA

25130102:

ELFRAMO SPA

819620107:

GRUPPO CIMBALI SPA

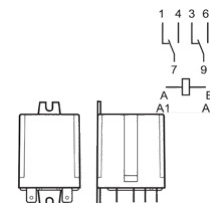

1109024 RELE'

TRIPOLARE 230V /

RELAY 230V MD80

229040:

ELETTROBAR

DIVISIONE DELLA
EUROTEC SRL

34200197*:

RANCILIO SPA

MD80: RANCILIO SPA

0301795:

LAMBER DI AFFABA

FRANCESCO & C.

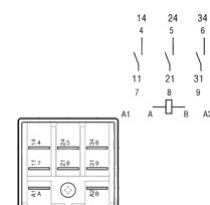
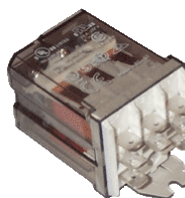

1109015 RELE' S20

220V /
RELAY S20 220V
RTFOC00144:
MBM- EUROTEC SRL -
DIV. COOKING
SERVICE
229024:
ELETTROBAR
23190:
BREMA ICE MAKERS
056510:
ELECTROLUX
085296:
ELECTROLUX
086214:
ELECTROLUX
PROFESSIONAL
S.P.A.
056466:
ELECTROLUX
PROFESSIONAL
S.P.A.
62023702:
SCOTSMAN ICE SRL
EU23190:
BRICE ITALIA SRL

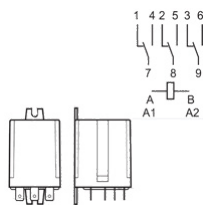

1109071 RELE' B1 230V AC-L / RELAY B1 230V AC-L *:

MBM- EUROTEC SRL -
DIV. COOKING
SERVICE
229008:
ELETTROBAR
DIVISIONE DELLA
EUROTEC SRL



1109046 RELE' A2- 230AC-L / RELAY A2-230AC-L 229030:

ELETTROBAR
DIVISIONE DELLA
EUROTEC SRL



1109028 RELE'2NO16 A 230VAC + FASTON / RELAY 2NO16 A 230VAC + FASTON

905476: SILANOS
SRL
905474EX:
SILANOS SRL

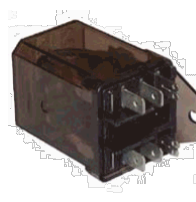

1109005 RELE'

FINDER TRIPOLARE
230V /
THREE POLAR RELAY
FINDER 230V
34200181:
RANCILIO SPA
34200192:
RANCILIO SPA
34200197:
RANCILIO SPA

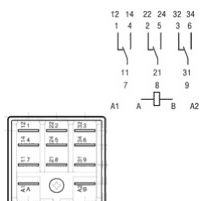
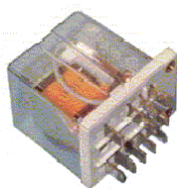

1109029 RELE' DI POTENZA 3 SCAMBI 16A 250VAC / POWER RELAY 3 CHANGES 16A 250VAC 905475: SILANOS SRL



1109021 RELE' MD 50 FINDER / RELAY MD 50 FINDER

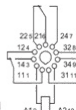
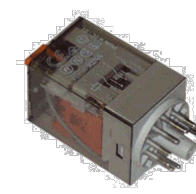

1109010 RELE' FINDER TRIP. 62838024 24VCA / THREE-POLAR RELAY FINDER 62838024 24VCA

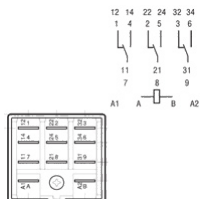
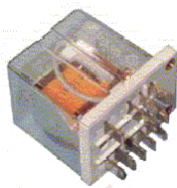

1109099 RELE 20A

230V /
RELAY 20A 230V
DER111:
COLGED

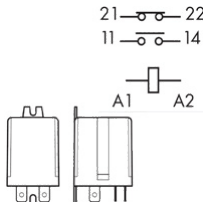
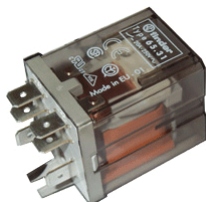

1109066 RELE SKR115 230V CON LED / RELAY SKR115 230V WITH LED

GIRR.CE VR-EV-ESP/2:
CB SRL



1109146 RELE' B2

230V AC-L /
RELE' B2 230V AC-L
229009:
ELETTROBAR
DIVISIONE DELLA
EUROTEC SRL



1109006 RITARDATO RE 2 POMPA 220V 6" R / "RELAY 2 PUMP 220V 6" R"

CETF6045A:
OMNIWASH SRL -
SOCIETA' A SOCIO
UNICO



1109121 "RITARDAT
ORE 2A POMPA 24V
RIT. 5-7"" 24V 62P" /
"TIME RELAY 24V RIT.
5-7"" 24V 62P""

CETF60:

OMNIWASH SRL -
SOCIETA' A SOCIO
UNICO



1109132 ADATTATO
RE CON BOCCOLE PER
RELE' S.62 /
ADAPTER FOR RELAY
S.62



1109002 CONTATTO
RE 12V CIMBALI DC /
CONTACTOR 12V
CIMBALI



1109011 MINICONTA
TTORE AB 230V NO /
MINICONTACTOR AB
230V

*****;

RANCILIO SPA

1109011: CARIMALI

HR0910: ADLER S.P.A.

9041202:

GRUPPO CIMBALI SPA

EN005: OEM ALI SPA

34200332:

RANCILIO SPA

34200219:

RANCILIO SPA

984144000:

GRUPPO CIMBALI SPA



1109018 TELERUTTO
RE LS07.4.00 /
RELAY LS07.4.00

34200220:

RANCILIO SPA



1109074 CONTATTO
RE 230 V. 50/60 HZ /
CONTACTOR 230V
50/60HZ

34200285EX:

RANCILIO SPA

34200293:

RANCILIO SPA

34200260:

RANCILIO SPA

34200285:

RANCILIO SPA



1109023 TRASFORM
ATORE TOR.75VA230V
EPOCA /
TRANSFORMER
TOR.75VA230V EPOCA

34200258:

RANCILIO SPA

34200281:

RANCILIO SPA



1109011 MINICONTA
TTORE AB 230V NO /
MINICONTACTOR AB
230V

*****;

RANCILIO SPA

1109011: CARIMALI

HR0910: ADLER S.P.A.

9041202:

GRUPPO CIMBALI SPA

EN005: OEM ALI SPA

34200332:

RANCILIO SPA

34200219:

RANCILIO SPA

984144000:

GRUPPO CIMBALI SPA



1109111 CONTATTO
RE /
CONTACTOR

57000:

DITTING

MASCHINEN AG



1109070 TELERUTTO
RE NP 80 /
CONTACTOR NP 80

9141210:

GRUPPO CIMBALI SPA



1109049 TELERUTTO
RE 230V /
CONTACTOR 230V

180024:

MAGISTER SISTEMA

CAFFE' SRL



1112141 TIMER MD
MACAP /
TIMER MD MACAP

C00061004:

MACAP SRL



1112158 TIMER
BIPOLARE MAZZER /
BIPOLAR TIMER
MAZZER
S000TIA02AQQ:
MAZZER LUIGI SPA

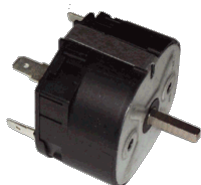

1112196 TIMER
TRIPOLARE /
TIMER
S000TIA03AQQ:
MAZZER LUIGI SPA



1112289 INTERRUPT
ORE TIMER
COMPLETO /
COMPLETE TIMER
SWITCH
88: ANFIM SRL



1112300 TIMER 1' /
TIMER 1'
EB1/1M: OBEL SRL
EB1/2M: OBEL SRL



1112303 TIMER /
TIMER
EB1: OBEL SRL



1112159 TIMER 440i
7GG 59' 12V 50HZ ITA X
6101010 E 6101011 /
TIMER 440i 7GG 59' 12V
50HZ ITA X 6101010 E
6101011



= 1112278

1112314 TIMER 740
CRONOMETRICO -ET
C/CHECK SALT 12V
50HZ - ITA /
TIMER 740 CHRONO-
METRIC -ET C / CHECK
SALT 12V 50HZ - ITA



1112278 MOTORINO
PER TIMER
ADDOLCITORI /
WATER SOFTNER
TIMER MOTOR



1114195 CENTRALIN
A AUTOLIVELLO BRSL
/
P.C. BOARD BRSL



1114005 TRASDUTT
ORE AUTOLIVELLO /
AUTOLEVEL
TRANSDUCTOR

1114005: WEGA SRL
180028:

MAGISTER SISTEMA
CAFFE' SRL

34200016:

RANCILIO SPA

1114005: SAN MARCO

1114005:

CMA MACCHINE PER
CAFFE' SRL



1114032 REG.
LIVELLO
COMPACT/MINICAF AS
/
LEVEL GOVERNOR
COMPACT/MINICAF AS
18045:

CMA MACCHINE PER
CAFFE' SRL



1114346 CENTRALIN
A LISA JUNIOR /
P.C.BOARD LISA
JUNIOR

18090066:

CMA MACCHINE PER
CAFFE' SRL



1114339 CENTRALIN
A ELETTRONICA /
P.C. BOARD
02473:

LA SPAZIALE SPA



1114512 CENTRALIN
A COMPACT 220V /
COMPACT CONTROL
UNIT 220V SPAZIALE
08570:

LA SPAZIALE SPA



1114150 CENTRALIN
A 1GRS. ES/60 230V /
P.C. BOARD 1GRS.
ES/60 230V
180087:
**MAGISTER SISTEMA
CAFFE' SRL**



1114353 SCATOLA
DOSATURA V230 /
P.C.BOARD 230V
180238ex:
**MAGISTER SISTEMA
CAFFE' SRL**
180090: **MAGISTER**
180239:
**MAGISTER SISTEMA
CAFFE' SRL**



1114009 CENTRALIN
A L7/S10 /
P.C. BOARD L7/S10
34070026:
RANCILIO SPA

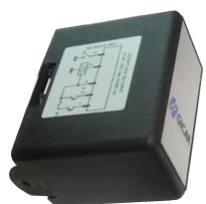

1114444 CENTRALIN
A RL30 MICROSP
LIVELLO SICUREZZA /
LEVEL CONTROLLER
230V AC
SR000070000:
SPINEL SRL



1114213 CENTRALIN
A GICAR RL30/1E-2C/F /
PC BOARD GICAR
RL30/1E-2C/F
91402300:
S.V. ITALIA SRL
SVTMR015:
S.V. ITALIA SRL



1114211 CENTRALIN
A DOS. 3 GR /
DOSING PC BOARD
3GR.
SV3GC003:
S.V. ITALIA SRL
95231601:
S.V. ITALIA SRL



1114362 CENTRALIN
A VIBIEMME /
ELECTRONIC
CONTROLLER
VIBIEMME



1114058 CENTRALIN
A LIV. 230+TIMEOUT /
P.C. BOARD LIV.
230+TIMEOUT
WY18080001:
**WEGA MACCHINE
PER CAFFE' SRL**
W10738EX:
**WEGA MACCHINE
PER CAFFE' SRL**



1114270 DOSATURA
MANUALE 1 GR. NO
TEA 230V AC /
P.C.BOARD 1 GR. NO
TEA 230V AC



1114363 CENTRALIN
A RL30 MICRO ST-S 230
VAC /
LEVEL RELAY RL30
ST-S 230 VAC



1114287 REGOLATO
RE DI LIVELLO RL30ST
230 VAC /
P.C. BOARD RL30ST 230
VAC



1114476 SENSORE DI
PRESSIONE
CIMBALI/FAEMA /
PRESSURE SENSOR
CIMBALI/FAEMA
M1, M2, M3, M32,
M39, M53, S39, S54:
FAEMA

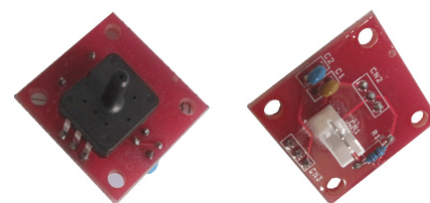

1114092 SCHEDA
AUTOLIVELLO + CAVO
EPOCA /
AUTOLEVEL P.C.
BOARD+ CABLE
EPOCA
34070171:
RANCILIO SPA
C10,EPOCA:
RANCILIO



1114320 TRASDUTT
ORE DI PRESSIONE
HUBA /
ELECTRONIC
PRESSURE SWITCH
HUBA
34200114ex:
RANCILIO SPA
34200288:
RANCILIO SPA



1114214 CENTRALIN
A DOS. 3D5 DELUXE
ECO AGIL 230-240V 50
Hz /
P.C.BOARD 3D5
DELUXE ECO AGIL
230-240V 50HZ
1942220008:
BRASILIA SPA



1114055 CENTRALIN
A ASTORIA /
P.C. BOARD ASTORIA
18090008:
**CMA MACCHINE PER
CAFFE' SRL**
18090016:
**CMA MACCHINE PER
CAFFE' SRL**



1114276 CENTRALIN
A 1-3GR 230V RL3 /
P.C.BOARD 1-3GR 230V
RL3
WY18090031:
WEGA SRL
18090031:
**CMA MACCHINE PER
CAFFE' SRL**



1114589 CIRCUITO
STAMPATO CMA /
PRINTED CIRCUIT
CMA
18090071:
**CMA MACCHINE PER
CAFFE' SRL**

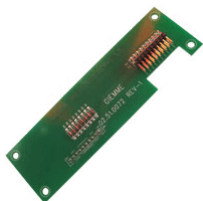

1114365 KIT SCHEDA
AVVIAMENTO 230V /
PC BOARD 230V
465822000: **FAEMA**



1114199 SCHEDA
ELETTRONICA FAEMA/
CIMBALI UNIFICATA /
P.C. BOARD
CIMBALI/FAEMA
537031801: **FAEMA**
537029600: **FAEMA**
3341135683: **FAEMA**
3341134100: **FAEMA**
537029600EX:
FAEMA
918910008: **FAEMA**
537031801EX: **FAEMA**



1114535 SCHEDA
AUTOLIVELLO FAEMA
/
WATER LEVEL BOARD
3341132863: **FAEMA**
3341135935: **FAEMA**
903011000: **FAEMA**
535514008: **FAEMA**
535514008:
GRUPPO CIMBALI SPA



1114095 CENTRALE
DOS. PAVONI BAR
438215 /
P.C.B. PAVONI BAR
438215
438265:
LA PAVONI SPA
438215:
LA PAVONI SPA

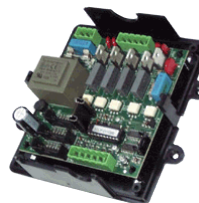

1114312 CENTRALIN
A DOS. LA PAVONI 1
GR 115V /
P.C. BOARD LA
PAVONI 1 GR 115V
951537:
LA PAVONI SPA



1114480 CENTRALIN
A ELET. 2 GR V APPIA /
PCB 2GR V APPIA
04900732:
**NUOVA SIMONELLI
SPA**



1114015 SCHEDA
RAU20 220V RANCILIO
/
P.C. BOARD RAU20
220V RANCILIO
S20: **RANCILIO SPA**



1114167 KIT SCHEDA
DE 02 /
P.C.BOARD DE 02
10700974:
RANCILIO SPA



1114341 KIT SCHEDA
E 03 /
P.C.BOARD E 03



1114136 KIT SCHEDA
DE03 /
P.C. BOARD DE03
EPOCA
C8: **RANCILIO SPA**



1114117 KIT SCHEDA
SDE 03 CPU /
P.C. BOARD SDE 03
CPU
10700973:
RANCILIO SPA

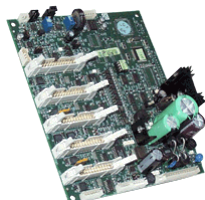

1114290 KIT SCHEDA
E06 /
PCB KIT E06
10700977:
RANCILIO SPA



1114668 KIT SCHEDA
E14 /
KIT ELECTRONIC
CARD E14
10700987:
RANCILIO SPA

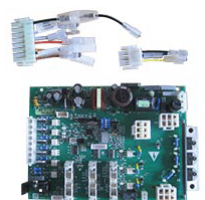

1114052 KIT SCHEDA
EPOCA /
P.C. BOARD B.T. CD-DE
EPOCA
34070173*:
RANCILIO SPA
10700972*:
RANCILIO SPA



1114004 SCHEDA
RAU/OMITIM
RANCILIO /
BOARD RAU/OMITIM
RANCILIO
MILLENIUM:
RANCILIO SPA

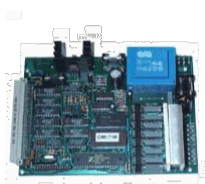

1114118 SCHEDA
ELETTRONICA
MILLENIUM 110V /
P.C. BOARD
MILLENIUM 110V
34070123:
RANCILIO SPA



1114051 SCHEDA
RELE' OMICRON
TIMER /
RELAY P.C. BOARD
OMICRON TIMER
34070111:
RANCILIO SPA

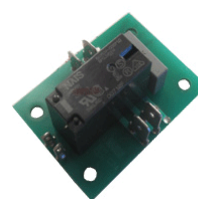

1114622 SCATOLA
ELETTRONICA 220-
240V 3D5 XLC BSC /
PC BOARD 220-240 3D5
XLC BASIC
34070218:
RANCILIO SPA



1114065 DOSATURA
MICROPROCESSORE /
MICROPROCESSOR
DOSE

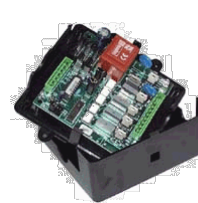

1114141 CABLAGGIO
ADATT.SCHEDA DE03-
00 /
CABLE FOR P.C.
BOARD DE03-00
10110476:
RANCILIO SPA



1114606 SCHEDA
ELETTRONICA SAN
MARCO SM95-22 /
ELECTRONIC BOARD
SAN MARCO SM95-22
108409: **SAN MARCO**

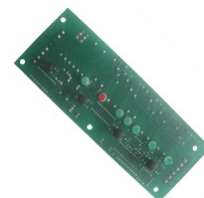

1114216 DISPLAY
LCD 16X2 BLU/BI
AGILE /
DISPLAY LCD 16X2
1942520008:
BRASILIA SPA

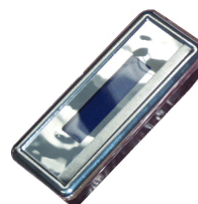

1114503 DISPLAY
GRAFICO FAEMA E92 /
GRAPHIC DISPLAY
Faema E92



1114494 DISPLAY
GRAFICO BLU
CIMBALI/FAEMA /
GRAPHIC DISPLAY
BLUE CIMBALI /
FAEMA
913902018: **FAEMA**

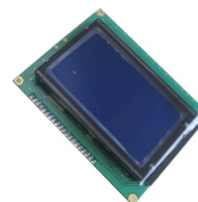

1114106 SCHEDA
DISPLAY C10/SDE /
DISPLAY P.C. BOARD
C10/SDE

34070192ex:
RANCILIO SPA
10705127:
RANCILIO SPA



1114215 PULSANTIE
RA 5T/5L BLU AGILE /
P.C.BOARD 5T/5L

1942720008:
BRASILIA SPA



1114217 PULSANTIE
RA 110/210 ME01220027
/
P.C.BOARD 110/210
ME01220027

1343120008:
BRASILIA SPA



1114218 PULSANTIE
RA COMPLETA
PFR/205R/CYR /
COMPLETE P.C.BOARD
PFR/205R/CYR

1312340008:
BRASILIA SPA



1114637 TASTIERA A
MEMBRANA LYXIR 1 /
KEYBOARD
MEMBRANE LYXIR 1

998136000:
CASADIO HBS SRL A
SOCIO UNICO



1114603 TASTIERA
POLICARBONATO /
KEYBOARD
POLYCARBONATE

998042000:
CASADIO HBS SRL A
SOCIO UNICO



1114170 PULSANTIE
RA THE 2 TASTI
ASTORIA DIVINA /
PC. PANEL 2 PUSH-
BUTTON ASTORIA
DIVINA

18371021:
CMA MACCHINE PER
CAFFE' SRL



1114171 PULSANTIE
RA THE 3 TASTI
ASTORIA DIVINA /
PC. PANEL 3 PUSH-
BUTTON ASTORIA
DIVINA

18371020:
CMA MACCHINE PER
CAFFE' SRL

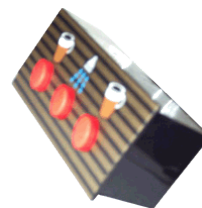

1114105 PULSANTIE
RA MEMBR. 5T SAE /
P.C. PANEL 5T SAE

18371025:
CMA MACCHINE PER
CAFFE' SRL



1114034 PULSANTIE
RA TIMER 220/240V
AEA 97 /
TIMER P.C. BOARD
220/240V AEA 97

21274:
CMA MACCHINE PER
CAFFE' SRL



1114023 PULSANTIE
RA 4T+1 CMA /
P.C. PANEL 4T+1 CMA

18354:
CMA MACCHINE PER
CAFFE' SRL



1114597 MEMBRANA
PULSANTIERA 7 TASTI
/
MEMBRANE
KEYBOARD 7
BUTTONS

20126045:
CMA MACCHINE PER
CAFFE' SRL



1114233 PULSANTIE
RA ACQUA C/SCH. E 91
AMBASSADOR /
WATER P.C. PANEL E
91 AMBASSADOR

909707008: FAEMA

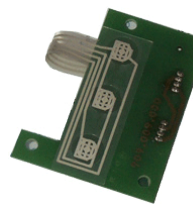

1114234 PULSANTIE
RA SX C/SCH. E91
AMBASSADOR /
LEFT P.C.PANEL E91
AMBASSADOR

909705008: FAEMA



1114235 PULSANTIE
RA DESTRA C/SCH. E91
AMBASSADOR /
RIGHT P.C.PANEL E91
AMBASSADOR
909706008: FAEMA



1114236 PULSANTIE
RA CAFFE' E 91
DIPLOMAT /
P.C.PANEL E91
DIPLOMAT
3301091861: FAEMA



1114237 PULSANTIE
RA ACQUA C/SCH E 91
DIPLOMAT /
WATER P.C.PANEL E91
DIPLOMAT
3301134295: FAEMA

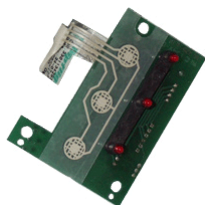

1114238 PULSANTIE
RA SX C/SCH. E91
DIPLOMAT A /
LEFT P.C.PANEL E91
DIPLOMAT A
3301135184: FAEMA



1114239 PULSANTIE
RA CENTRALE E91
DIPLOMAT A /
P.C.PANEL E91
DIPLOMAT A
3301132572: FAEMA

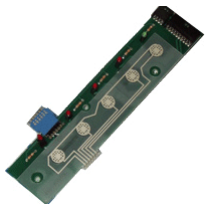

1114240 PULSANTIE
RA DX C/SCH E 91
DIPLOMAT /
RIGHT P.C.PANEL E91
DIPLOMAT A
3301132571: FAEMA



1114241 PULSANTIE
RA SX E92 ELITE /
LEFT P.C.PANEL E92
ELITE
902766008: FAEMA



1114242 PULSANTIE
RA CENTRALE E 92
ELITE /
P.C.PANEL E92 ELITE
902768008: FAEMA

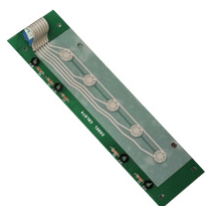

1114243 PULSANTIE
RA DX E92 ELITE A /
RIGHT P.C.PANEL E92
ELITE A
902767008: FAEMA



1114244 PULSANTIE
RA SX E92 ELITE S /
LEFT P.C.PANEL E92
ELITE S
902769008: FAEMA



1114245 PULSANTIE
RA CENTRALE E 92/S /
P.C.PANEL E92/S
902771008: FAEMA



1114246 PULSANTIE
RA DX E92/S /
RIGHT P.C.PANEL
E92/S
902770008: FAEMA



1114247 PULSANTIE
RA E98/A PRESIDENT /
P.C.PANEL E98/A
PRESIDENT
3301134927: FAEMA



1114487 PULSANTIE
RA E 97/M27 /
PUSH BUTTON E
97/M27
915400000: FAEMA



1114430 PULSANTIE
RA SELEZIONI ENOVA
AUTOMATICA /
KEYPAD PCB ENOVA
AUTOMATIC
915313010: FAEMA
915173000: FAEMA



1114342 PULSANTIE
RA ENOVA FAEMA /
KEYPAD UNIT ENOVA
FAEMA
91517300: FAEMA



1114491 PULSANTIE
RA ENOVA
RETYLING /
PUSH BUTTON ENOVA
RETYLING
915173000: FAEMA



1114155 PULSANTIE
RA ELETTRONICA
NUOVA ARIETE
FUTURMAT /
P.C. PANEL NUOVA
ARIETE FUTURMAT



1114515 Pulsantiera
Completa Di Tasto E
Interruttore Per Twenty /
Push-button Key And Full
Of Switch DOR TWENTY
1114515: GRIMAC



1114458 PULSANTIE
RA M21 DOSATA /
P.C. PANEL M21



1114481 PULSANTIE
RA CIMBALI M27 /
CIMBALI M27 PUSH
BUTTON



1114561 PULSANTIE
RA SELEZIONE ACQUA
M28 /
SELECTION PANEL
WATER M28



1114632 PULSANTIE
RA DI COMANDO M28 /
PUSHBUTTON
CIMBALI M28
435030000:
GRUPPO CIMBALI SPA



4116555 ETICHETTA
SELEZ. CAFFE' M39 /
LABEL COFFEE
SELECTION M39



4116556 ETICHETTA
SERVIZI M39 DT /
LABEL SERVICES M39
DT



4116557 TARGA
SELEZIONE
CAPUCCINO /
PLATE SELECTION
CAPUCCINO



4116558 TARGHETT
A SERIGRAFATA DT2 /
PLATE silkscreened DT2



4116559 ETICHETTA
LATTE M39 /
MILK LABEL M39



4116560 ETICHETTA
AUTOSTEAM M39 /
LABEL AUTOSTEAM
M39



4116561 TARGA
VAPORE /
PLATE STEAM



2105005 MEMBRANA
DIGITALE VMT /
DIGITAL MEMBRANE
DOSING PUMP VMT

438300:

LA PAVONI SPA



1114440 TASTIERA
SILICONE 5 TASTI PER
PULSANTIERA S3 /
P.C. PANEL 5 PUSH-
BUTTONS

05498:

LA SPAZIALE SPA



1114450 TARGHETT
A PULSANTIERA NEW
EK /
P.C. PANEL NEW EK

02475:

LA SPAZIALE SPA



1114699 PULSANTIE
RA A MEMBRANA 5
TASTI
PROGRAMMAZIONE S5
/
S5 MEMBRANE
KEYBOARD 5
BUTTONS

08500:

LA SPAZIALE SPA



1114559 CIRCUITO
PULSANTIERA 5 TASTI
S5 /
CIRCUIT PANEL
KEYPAD 5 S5

08503:

LA SPAZIALE SPA

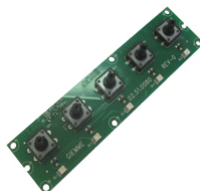

PANEL=1114558

1114441 CIRCUITO
PULSANTIERA 5 TASTI
S3 /
PCB FOR P.C. PANEL 5
PUSH-BUTTONS

06001:

LA SPAZIALE SPA

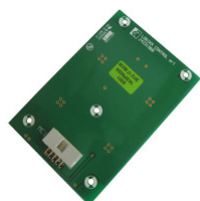

1114558 PULSANTIE
RA 5 TASTI COMPLETA
CON FONDO S5 /
5 PANEL BUTTONS
COMPLETE WITH
BOTTOM S5

08494:

LA SPAZIALE SPA



BOARD=1114559

1114473 FRONTALE
PULSANTIERA 5 TASTI
S5 /
CONTROL PANEL 5
PUSH BUTTOM S5

08491:

LA SPAZIALE SPA



1114594 ASSIEME
PULSANTIERA 5 TASTI
S8-S9 /
ASSEMBLY
KEYBOARD 5
BUTTONS S8-S9

10774:

LA SPAZIALE SPA



1114104 PULSANTIE
RA 6 TASTI /
P.C. BOARD 6 PUSH-
BUTTONS

180095:

MAGISTER SISTEMA
CAFFE' SRL



1114168 PULSANTIE
RA 6 TASTI /
PC. PANEL 6 PUSH-
BUTTON

900149:

MAGISTER SISTEMA
CAFFE' SRL



1114007 TASTO
ACQUA OMICRON /
WATER PUSH-BUTTON
OMICRON

10111020:

RANCILIO SPA

34030036:

RANCILIO SPA



1114642 TASTO
EROGAZIONE CAFFE'
CLASSE 7 S /
BUTTON COFFEE
BREWING 'CLASS 7 S

10705679:

RANCILIO SPA



1114640 TASTO
ACQUA C7 /
BUTTON WATER C7

10705680:

RANCILIO SPA



1114046 PULSANTIE
RA MILLENNIUM CDX /
P.C. BOARD
MILLENNIUM CDX
10705231:
RANCILIO SPA



1114134 PULSANTIE
RA CAFFE' C10-S /
COFFEE P.C. PANEL
C10-S
10705362:
RANCILIO SPA

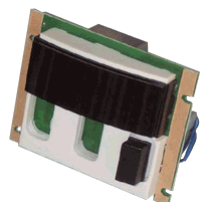

1114186 PULSANTIE
RA FUNZIONI S /
PC. PANEL S
10705364:
RANCILIO SPA

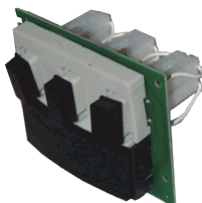

1114107 PULSANTIE
RA FUNZIONI TSC /
P.C. PANEL TSC
10705365:
RANCILIO SPA

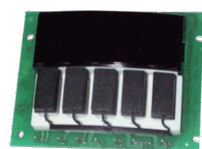

1114116 PULSANTIE
RA CAFFE' C 10 SDE /
COFFEE P.C. PANEL C
10 SDE
10705348:
RANCILIO SPA
10705361:
RANCILIO SPA

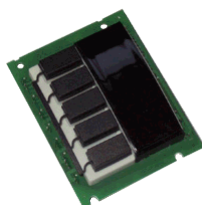

1114661 SCHEDA+TA
STIERA
PROGRAMMAZIONE /
BOARD + KEYBOARD
PROGRAMMING
10111042:
RANCILIO SPA

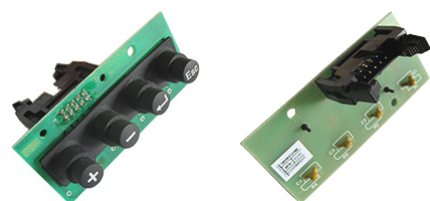

1114204 PULSANTIE
RA CAFFE' DE /
COFFEE PC PANEL DE
10705367:
RANCILIO SPA



1114006 PULSANTIE
RA Z9DE /
P.C. BOARD Z9DE
34070030:
RANCILIO SPA



1114546 TASTIERA
CAFFEC'7 E /
KEYBOARD
CAFFEC'7E
10705678:
RANCILIO SPA



1114044 SCHEDA+TA
STIERA EPOCA DE /
P.C. BOARD EPOCA DE
10111031:
RANCILIO SPA



1114623 PULSANTIE
RA DOSATA BASIC /
PANEL DOSING -BASIC
34070216:
RANCILIO SPA



1114387 PULSANTIE
RA 5 TASTI SAB /
KEYPAD PCB
BUTTONS 5 SUITABLE
FOR SAB
SVMNP004:
S.V. ITALIA SRL

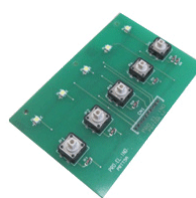

1114388 PULSANTIE
RA THE 2 TASTI SAB /
KEYPAD PCB
BUTTONS 2 SAB
SVMNP005:
S.V. ITALIA SRL

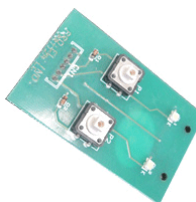

1114212 CENTRALIN
A GICAR DOSTH /
PC BOARD GICAR
DOSTH
951752:
S.V. ITALIA SRL



1114306 C.S.MEMBR
ANA 5 T POLARIS
COMPLE /
P.C. BOARD 5 T
POLARIS COMPLETE
WY18371086:
WEGA SRL



1114307 MEMBR.PUL
S.5T POLARIS /
P.C. PANEL 5T
POLARIS
WY20126014:
WEGA MACCHINE
PER CAFFE' SRL



1114394 PULSANTIE
RA 5 TASTI DOSATURA
OPT /
KEYPAD UNIT 5
BUTTONS



1114423 PULSANTIE
RA PROMAC BLU
LIGHT /
KEYPAD UNIT
PROMAC BLUE LIGHT



1114648 PULSANTIE
RA FRESCOBALDI
JUNIOR CROMO 5T/5L
"BL" /
PUSH BUTTON
FRESCOBALDI JUNIOR
CHROME 5T / 5L "BL"



1114649 PULSANTIE
RA CORELLI BLACK
6T/6L "BI" /
PUSH-BUTTON PANEL
- BLACK CORELLI 6T6L
"BI"



1114132 DOSATURA
DOS.TH SMT
IGR+RL230V /
P.C. BOARD TH SMT
IGR+RL230V



1114328 CONTATOR
E VOLUMETRICO 3 VIE
FAEMA /
VOLUMETRIC METER
3 WAYS FAEMA
2251131855: FAEMA



1114382 CONTATOR
E VOLUMETRICO
CABLATO DIGMESA /
FLOW CONTROLLER
534392300: FAEMA
534393100:
GRUPPO CIMBALI SPA
534391800: FAEMA



1114692 Contatore
Volumetrico Digmesa In
Ottone Orif. 1,2 Mm /
VOLUMETRIC METER



1114169 CONTATOR
E VOLUMETRICO MPM
/
VOLUMETRIC METER
MPM



O-RING= 2101324,
FAN= 3109002

1114492 Contatore
Volumetrico Gicar - 1.15 (/
1/4) /
Volumetric Counter Gicar
- 1:15 (1/4)



1114539 CONTATOR
E VOLUMETRICO
FORO 1,15mm /
VOLUMETRIC METER
HOLE 1.15 mm
02498:
LA SPAZIALE SPA



1114003 CONTATOR
E VOLUMETRICO /
VOLUMETRIC METER
10705201:
RANCILIO SPA
180040:
MAGISTER SISTEMA
CAFFE' SRL
SVTMC016:
S.V. ITALIA SRL



O-RING= 2101324,
FAN = 3109002

1114595 SCHEDA
PROGR. 230V M4D-M5D
/
PC BOARD M4D-M5D
M4D-M5D: MACAP
SRL



1114633 DISPLAY
M5D /
DISPLAY M5D
C0006M105:
MACAP SRL



1114408 SCHEDA
TIMER D. 220-240V EL.
C /
PCB 220-240V
S000SCT06AQQ:
MAZZER LUIGI SPA



1114605 SCHEDA
TIMER DOPPIO
110V/60HZ PER MINI B
ELETTRONICO /
P.C. BOARD TIMER
DOUBLE 110V / 60HZ
TO MINI B
ELECTRONIC
S000SCT09:
MAZZER LUIGI SPA

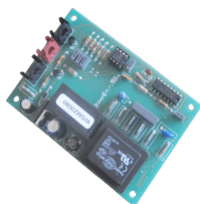

1114393 SCHEDA
PULSANTI C/DISPLAY /
KEYPAD PCB WITH
DISPLAY
S000SPU03CQQ:
MAZZER LUIGI SPA

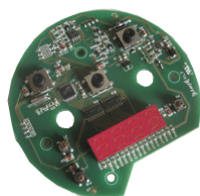

4118205 MEMBRANA
ADESIVA CON
FINESTRA DISPLAY /
ADHESIVE
MEMBRANE WITH
DISPLAY SCREEN
WINDOW
S000MEM01AQQ:
MAZZER LUIGI SRL



1107126 MICRO 16A
NO STRUTTURA
METALLICA 23700 /
MICRO-SWITCH 16A
23700

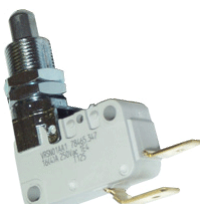

1107077 MICROINTE
RRUTTORE CON
TASTO ROSSO /
MICRO-SWITCH WITH
RED PUSH-BUTTON
GIRARROSTI: CB SRL
0101184:
SILKO ALI SPA



1107026 MICROINTE
RRUTTORE DI
SICUREZZA /
SAFETY MICRO-
SWITCH
PR70011: FABA SRL



1107078 ASSIEME
MICRO PORTA P80 /
MICRO-DOOR P80
984759000:
GRUPPO CIMBALI
SPA
9131735:
GRUPPO CIMBALI
SPA

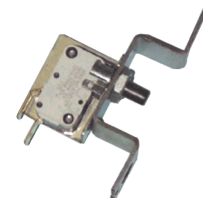

1107128 MICROINTE
RRUTTORE DI
SICUREZZA 3
CONTATTI 16A /
SAFETY MICRO-
SWITCH 3 CONTACTS
4818135868: FAEMA
120313:
COMENDA ALI SPA
532020310: FAEMA
532020300: FAEMA
1519: FOINOX S.P.A.
539502: GICO SPA
LAR65260530:
LAINOX ALI SPA
50304530:
LAINOX ALI SPA



1107178 MICRO
MOD. N16 CON
PULSANTE /
MICROSWITCH N16
WITH PUSH BUTTON
120304:
COMENDA ALI SPA



1107035 ASS. MICRO
TELE. DOPPIO
SICUREZZA PORTA /
MICRO SWITCH WITH
PRESSURE PIN
2651:
ARISTARCO KASTEL
SPA
PASSPORT45.30/50.3
2/50.35/55.40,MAST
ER22,PROJET28E/EM
,ALISEO:
ARISTARCO KASTEL
SPA



1107215 MICRO
COMPLETO AE35 /
MICRO COMPLETE
AE35
12271:
ARISTARCO KASTEL
SPA



1107222 MICROINTE
RRUTTORE BIPOLARE
M10X0.75 /
BIPOLAR
MICROSWITCH
M10X0.75
33059400:
BERTO'S SPA



1107016 MICRO
INTERRUTTORE
Z15GO OMRON /
MICRO-SWITCH Z15GO
OMRON
65260540:
LAINOX ALI SPA
LAR65260540:
LAINOX ALI SPA
LAR65260540:
OLIS DIVISIONE DI
ALI GROUP SPA -



1107060 MICRODEVI
ATORE A.PO /
MICRO-SWITCH A.PO
32W0960:
ANGELO PO GRANDI
CUCINE SPA



1107121 MICROINTE
RRUTTORE PER
TROPPO PIENO
GHIACCIO /
ICE OVER FLOW
MICROSWITCH
23373:
BREMA ICE MAKERS
SPA



1107176 FINECORSA
A PULSANTE MF17 /
LIMIT SWITCH MF17
532097000: FAEMA
DW70305:
DIHR-ALI SPA



1107189 MICROINTE
R.PULS.FILETT+ROT.B
M2 /
MICROSWITCH WITH
BUTTON
EG03200:
OEM ALI SPA



1107190 MICRO
PULS.FIL.C/ROT.TRAS
V.BM2 /
MICROSWITCH WITH
BUTTON
EG03700:
OEM ALI SPA



1107075 MICRO
INTERRUTTORE X
TUTTE LEVETTA-
ANTICA /
MICRO-SWITCH
SVTMM008:
S.V. ITALIA SRL



1107091 MICRODEVI
ATORE 15A PRESS. A
LEVA /
MICRO-SWITCH 15A



1107054 MICRO
PORTA+MAGNETE BR-
BC-FC /
MICRO-
DOOR+MAGNET BR-
BC-FC
120346:
COMENDA ALI SPA



1107056 MICRO
8319072 5A LEVA B A
VITE /
MICRO 8319072 5A
LEVER B WITH SCREW
CM19410205/0:
CASTEL MAC SPA
CM19410205:
SCOTSMAN ICE SRL
CM19410205/0:
CASTEL MAC SPA

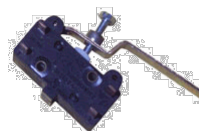

1107006 MICRO Z15
HW 24B34049 /
MICRO-SWITCH Z15
HW 24B34049
CM19410200/0:
CASTEL MAC SPA



1107144 SWITCH
LIMIT (620395) /
SWITCH LIMIT (620395)
1200205901:
SCOTSMAN ICE SRL



1107092 MICRODEVI
ATORE LEVA PIANA
CONT. /
MICRO-SWITCH

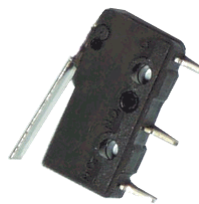

1107093 ATTUATORE
E LEVA SAGOMATA /
MICRO-SWITCH

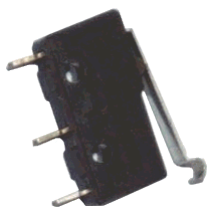

1107094 MICRODEVI
ATORE A PULSANTE
CONTINUO /
MICRO-SWITCH WITH
PUSH-BUTTON



1107095 ATTUATORE
E A LEVA CON
ROTELLA CONT. /
MICRO-SWITCH WITH
SMALL WHEEL

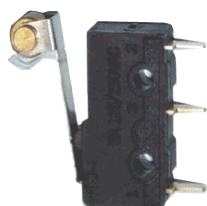

1107096 MICRODEVI
ATORE LEVA PIANA
3A 250V TERM. CORSA
/
MICRO-SWITCH 3A
250V



1107097 MICRODEVI
ATORE LEVA SAGOM.
CTERM. PER C.S3A UL
/
MICRO-SWITCH 3A UL

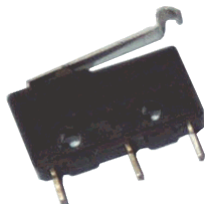

1107098 MICRODEVI
ATORE A PULSANTE
TERM PER C.S. 3 A UL /
MICRO-SWITCH 3A UL

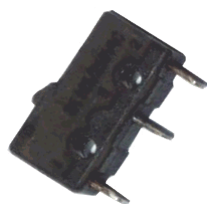

1107099 MICRODEVI
ATORE C/ROTELLA
TERM 3A /
MICRO-SWITCH WITH
SMALL WHEEL 3A



1107100 ATTUATORE
E A LEVA FASTON 4,8
LEVA 52MM /
MICRO-SWITCH
FASTON 4,8 52mm



1107101 MICROINTE
RRUTTORE A LEVA
C.ROTELLA FASTON
4,8 /
MICRO-SWITCH WITH
SMALL WHEEL
FASTON 4,8



1107235 #MICRO
FINECORSA DI
CHIUSURA /
LIMIT MICROSWITCH
DW10600138:
DIHR-ALI SPA



1107105 FINECORSA
PIST.C.ROTELLA
UNIDIREZ. /
MICRO-SWITCH WITH
SMALL WHEEL



1107120 MICROINTE
RRUTTORE /
MICROSWITCH
23746:
BREMA ICE MAKERS
SPA



1107043 FINECORSA
FD 102 COMENDA /
MICRO-SWITCH FD 102
COMENDA
120326:
COMENDA ALI SPA



1107069 MICRO CON
LEVA LC/
MICROSWITCH LC
120364:
COMENDA ALI SPA



1107073 MICRO
FINECORSA LEVA
GIREVOLE FD552-S2 /
MICRO-SWITCH FD552-
S2
120320:
COMENDA ALI SPA
H120320:
HOONVED - ALI SPA



1107179 MICROINTE
RRUTTORE DI FINE
CORSA /
LIMIT MICROSWITCH

927304:

ELETTROBAR
DIVISIONE DELLA
EUROTEC SRL

*:

MBM- EUROTEC SRL -
DIV. COOKING
SERVICE



4120073 LEVA
MICRO MOD. FD 503 /
POSITION SWITCH
MOD. FD 503

H870129EX:

HOONVED - ALI SPA
33435:

HOONVED - ALI SPA



1107109 FINECORS
STELO A MOLLA /
LIMIT MICROSWITCH
MICRO-SWITCH



1107111 FINECORS
ASTA IN POLIAMMIDE
/
MICRO-SWITCH



1107225 MAGNETE
CASADIO /
MAGNET CASADIO
998045000:

CASADIO HBS SRL A
SOCIO UNICO



1107083 SCATOLA
MICRO AUTOM. SX
COMPLETO /
COMPLETE LEFT
MICRO SWITCH
AUTOM.

C0007M139:

MACAP SRL



1107184 MICROINTE
RRUTTORE DI
SICUREZZA CAMPANA
/
SAFETY
MICROSWITCH FOR
HOPPER

S000INR01QQQ:
MAZZER LUIGI SPA



1107089 MICROINT
ERRUTTORE
(NORMALMENTE
APERTO) /
MICRO-SWITCH
OPEN

23372:

BREMA ICE MAKERS
SPA

68023372:

RANCILIO SPA
9544800: MEIKO



1107088 MICROINT
ERRUTTORE
(NORMALMENTE
CHIUSO) /
MICRO-SWITCH

68023196:

RANCILIO SPA

085298:

ELECTROLUX
PROFESSIONAL
S.P.A.

23196:

BREMA ICE MAKERS
SPA



1107186 MICROGA
LLEGIANTE C/LEVA
74X7 VR-NA 15GR
2CONT. /
MICRO-SWITCH
FLOATER WITH
LEVER 74X7 VR-NA
15GR 2CONT.

926054:

BRICE ITALIA SRL



1107122 MICROSWI
TCH X COD.2131 3/4 /
MICROSWITCH X
COD.2131 3/4

L2136: LUXIA SRL



1107058 MICRO
INVERSO 3 POLI /
MICRO-REVERSER 3
POLES



1107031 MICROINT
ERRUTTORE GH2 3
CONTATTI /
MICRO-SWITCH GH2
3CONCATS

23055:

BREMA ICE MAKERS
SPA



1107133 MICRO A
LEVA LUNGA /
MICRO SWITCH
LONG LEVER
CM19410207/0:
CASTEL MAC SPA

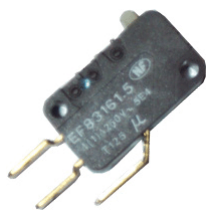

1107208 MICRO
FAEMA 3000
MONOFASE /
FAEMA PHASE
MICRO 3000
3342133738: FAEMA



1107037 MICRO
ARRESTO MD/AT /
STOP MICRO-SWITCH
MD/AT
34100003:
RANCILIO SPA



1107137 LEVA
LUNGA CON
ROTELLA X(058) /
LEVER WITH ROLL
FOR MICROSWITCH
1107058



1107042 MICROINT
ERRUTTORE
AH715378 /
MICRO SWITCH
AH715378
32W4240:
ANGELO PO GRANDI
CUCINE SPA
50123*: CEADO SRL
DW10704:
DIHR-ALI SPA
10704: DIHR-ALI
SPA



1107082 MICRO
DEVIATORE 16A
C/LEVA /
MICRO-SWITCH 16A
PASSPORT1040,
GL1040, GL1240:
ARISTARCO KASTEL
C00061023:
MACAP SRL
808053: EMMEPI
862311: OFFCAR
1037111300:
SILKO ALI SPA
25190007:
ELFRAMO SPA
6043085: GIORIK
SPA
30610:
SISTEMA PROJECT

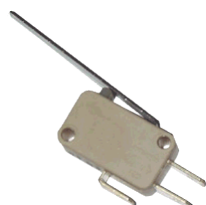

MA1037111300:
SILKO ALI SPA
MA1037111300:
MARENO
INDUSTRIE
01035: FABAR SRL

1107052 MICRODE
V. S 16 CON LEVA
16829C /
MICRO-SWITCH S 16
WITH LEVER 16829C
120323:
COMENDA ALI SPA

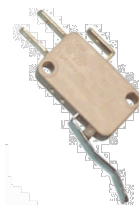

1107221 MICROINT
ERRUTTORE
DEVIATORE N16 /
MICRO SWITCH
DEVIATOR N16
25190003:
ELFRAMO SPA



1107117 MICROPOR
TA MOD.E34/86HNG /
DOOR
MICROSWITCHO.E34/
86HNG
3121030: LASA SRL

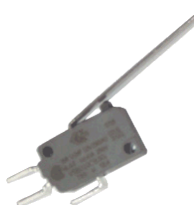

1107193 MICRO
INFERIORE
COMPLETO /
LOWER COMPLETE
MICROSWITCH
S00SMIA04AQQQe
x: MAZZER LUIGI
SPA
S00SMIA11QQQ:
MAZZER LUIGI SPA



1107166 MICROINT
ERRUTTORE PORTA /
DOOR MICROSWITCH
4095:
UNIVER-BAR SRL



1129266 ASSIEME
SENSORE LIVELLO
CASADIO /
LEVEL SENSOR
ASSEMBLY CASADIO
998709000:
CASADIO HBS SRL A
SOCIO UNICO



1129265 SONDA
TEMPERATURA
CASADIO /
TEMPERATURE
SENSOR CASADIO
998546010:
CASADIO HBS SRL A
SOCIO UNICO



1129036 SONDA
TERMICA FAEMA /
THERMIC BORE
FAEMA

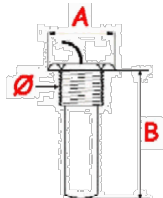

A = 29 mm, B = 42 mm, Ø
= 20 mm,

1129169 SONDA
LIVELLO CALDAIA /
LEVEL BORE



1115038 POTENZIO
METRO 5 KOHM
MAHLKOENIG /
POTENTIOMETER 5
KOHM MAHLKOENIG
7501:
MAHLKOENIG GmbH
& Co. Kg



1129275 SONDA
TEMPERATURA 3/8
CABLATA /
TEMPERATURE
SENSOR 3/8 CABLED
05060:
LA SPAZIALE SPA



1129040 SONDA
TEMPERATURA
EPOCA 3/8" /
"TEMPERATURE BORE
EPOCA 3/8""
34070174:
RANCILO SPA



= 2102036

1129163 SONDA
LIVELLO /
LEVEL BORE
537024900:
FAEMA



1129018 SONDA
AUTOLIVELLO 125MM
/
AUTOLEVEL BORE
125MM
20251:
CMA MACCHINE PER
CAFFE' SRL



1129287 SONDA DI
SICUREZZA
COMPLETA /
COMPLETE SECURITY
PROBE
793103610: GICO SPA



1129288 ASSIEME
SONDA LIVELLO /
COMPLETE LEVEL
PROBE
793103600: GICO
SPA



3109002 GIRANTE
CONTATORE
VOLUMETRICO /
VOLUMETRIC METER
FAN

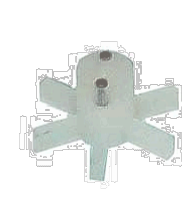

1103842 VENTOLINA
PER
MOTOFRULLATORE
CASADIO /
Fan MOTOR-BLENDER
CASADIO
99805300:
CASADIO HBS SRL A
SOCIO UNICO



SPIE LUMINOSE / LUMINOUS LIGHTS



S&P CODE	TYPE	DIMENSIONI DIMENSIONS	V	COLORE COLOR	S&P CODE	TYPE	DIMENSIONI DIMENSIONS	V	COLORE COLOR
1104013	A	Ø=10mm	230V	ARANCIO ORANGE	1104072	D	Ø=12mm	250V	VERDE GREEN
1104012	A	Ø=10mm	230V	VERDE GREEN	1104073	D	Ø=12mm	250V	ROSSO RED
1104071	B	Ø=10mm	250V	ARANCIO ORANGE	1104034	F	Ø=12mm	250V	ARANCIO ORANGE
1104070	B	Ø=10mm	250V	VERDE GREEN	1104033	F	Ø=12mm	250V	VERDE GREEN
1104107	B	Ø=10mm	250V	VERDE GREEN	1104032	F	Ø=12mm	250V	ROSSO RED
1104069	B	Ø=10mm	250V	ROSSO RED	1104042	E	Ø=10mm	380V	ARANCIO ORANGE
1104024	C	Ø=10mm	250V	ARANCIO ORANGE	1104044	E	Ø=10mm	380V	VERDE GREEN
1104025	C	Ø=10mm	250V	VERDE GREEN	1104043	E	Ø=10mm	380V	ROSSO RED
1104062	D	Ø=10mm	250V	ARANCIO ORANGE	1104066	B	Ø=10mm	400V	ARANCIO ORANGE
1104060	D	Ø=10mm	250V	VERDE GREEN	1104068	B	Ø=10mm	400V	VERDE GREEN
1104061	D	Ø=10mm	250V	ROSSO RED	1104067	B	Ø=10mm	400V	ROSSO RED
1104057	E	Ø=10mm	250V	ARANCIO ORANGE	1104232	B	Ø=10mm	12V	ROSSO RED
1104058	E	Ø=10mm	250V	VERDE GREEN	1104063	B	Ø=10mm	24V	ARANCIO ORANGE
1104059	E	Ø=10mm	250V	ROSSO RED	1104065	B	Ø=10mm	24V	VERDE GREEN
1104087	B	Ø=12mm	250V	ARANCIO ORANGE	1104064	B	Ø=10mm	24V	ROSSO RED
1104086	B	Ø=12mm	250V	VERDE GREEN	1104054	E	Ø=10mm	24V	ARANCIO ORANGE
1104085	B	Ø=12mm	250V	ROSSO RED	1104055	E	Ø=10mm	24V	VERDE GREEN
1104074	D	Ø=12mm	250V	ARANCIO ORANGE	1104056	E	Ø=10mm	24V	ROSSO RED

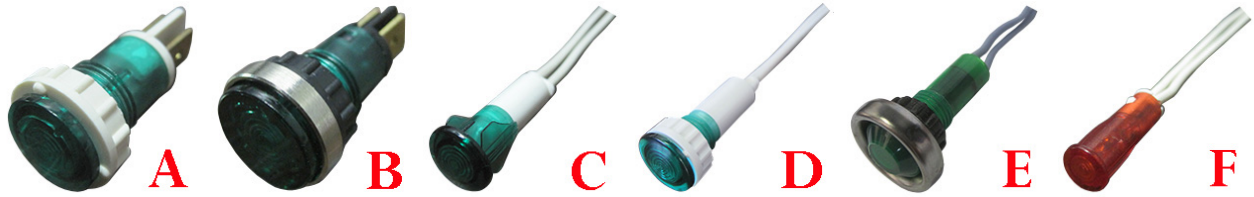

S&P CODE	TYPE	DIMENSIONI DIMENSIONS	V	COLORE COLOR	S&P CODE	TYPE	DIMENSIONI DIMENSIONS	V	COLORE COLOR
1104029	D	Ø=10mm L=200mm	230V	VERDE GREEN	1104078	F	Ø=6mm L=200mm	380V	VERDE GREEN
4118166	E	Ø=10mm L=400mm	230-400V	VERDE GREEN	1104077	F	Ø=6mm L=200mm	380V	ROSSO RED
1104084	F	Ø=6mm L=200mm	250V	ARANCIO ORANGE	1104237	D	Ø=10mm L=200mm	380V	VERDE GREEN
1104080	F	Ø=6mm L=200mm	250V	VERDE GREEN	1104051	C	Ø=10mm L=200mm	400V	ARANCIO ORANGE
1104083	F	Ø=6mm L=200mm	250V	ROSSO RED	1104053	C	Ø=10mm L=200mm	400V	VERDE GREEN
1104267	F	Ø=6mm L=200mm	250V	BLU BLUE	1104052	C	Ø=10mm L=200mm	400V	ROSSO RED
1104045	C	Ø=10mm L=200mm	250V	ARANCIO ORANGE	1104201	B	Ø=12mm	400V	ARANCIO ORANGE
1104047	C	Ø=10mm L=200mm	250V	VERDE GREEN	1104199	B	Ø=12mm	400V	VERDE GREEN
1104046	C	Ø=10mm L=200mm	250V	ROSSO RED	1104200	B	Ø=12mm	400V	ROSSO RED
1104178	A	Ø=12mm	250V	ARANCIO ORANGE	1104082	F	Ø=6mm L=200mm	24V	ARANCIO ORANGE
1104179	A	Ø=12mm	250V	VERDE GREEN	1104081	F	Ø=6mm L=200mm	24V	VERDE GREEN
1104177	A	Ø=12mm	250V	ROSSO RED	1104079	F	Ø=6mm L=200mm	24V	ROSSO RED
1104181	B	Ø=12mm	250V	ARANCIO ORANGE	1104048	C	Ø=10mm L=200mm	24V	ARANCIO ORANGE
1104182	B	Ø=12mm	250V	VERDE GREEN	1104050	C	Ø=10mm L=200mm	24V	VERDE GREEN
1104180	B	Ø=12mm	250V	ROSSO RED	1104049	C	Ø=10mm L=200mm	24V	ROSSO RED
1104076	F	Ø=6mm L=200mm	380V	ARANCIO ORANGE	1104222	D	Ø=10mm	24V	BIANCO WHITE

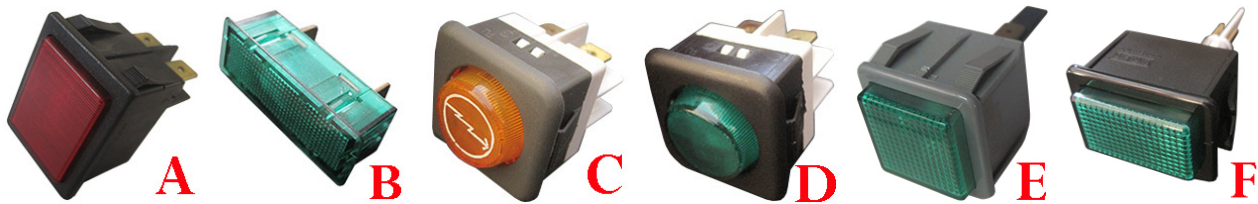

S&P CODE	TYPE	DIMENSIONI DIMENSIONS	V	COLORE COLOR	S&P CODE	TYPE	DIMENSIONI DIMENSIONS	V	COLORE COLOR
1104014	C	25X25mm	220V	ARANCIO ORANGE	1104039	A	22X30mm	230V	VERDE GREEN
1104197	D	25X25mm	220V	VERDE GREEN	1104040	A	22X30mm	230V	ROSSO RED
1104106	E	28,5X28,5mm	220V	VERDE GREEN	1104176	B	10X34mm	400V	ARANCIO ORANGE
1105209	F	22X32mm	220V	VERDE GREEN	1104175	B	10X34mm	400V	VERDE GREEN
1104041	A	22X30mm	230V	ARANCIO ORANGE	1104218	A	22X30mm	24V	ARANCIO ORANGE

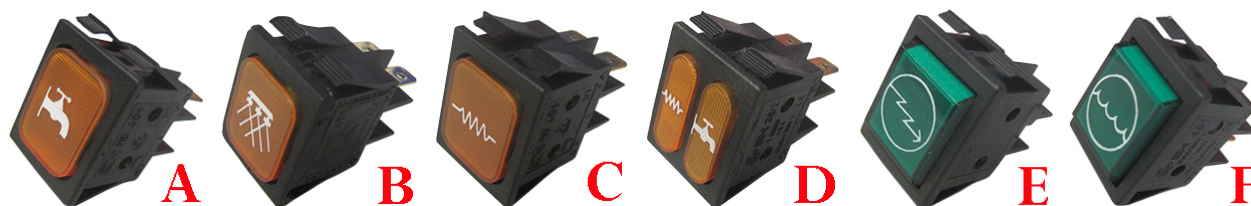

S&P CODE	TYPE	DIMENSIONI DIMENSIONS	V	COLORE COLOR	S&P CODE	TYPE	DIMENSIONI DIMENSIONS	V	COLORE COLOR
1104143	A	22X28mm	220V	ARANCIO ORANGE	1104134	E	22X28mm	220V	VERDE GREEN
1104146	B	22X28mm	220V	ARANCIO ORANGE	1104140	F	22X28mm	220V	VERDE GREEN
1104148	C	22X28mm	220V	ARANCIO ORANGE	1104147	B	22X28mm	12V	ARANCIO ORANGE
1104149	D	22X28mm	220V	ARANCIO ORANGE	1104150	C	22X28mm	12V	ARANCIO ORANGE

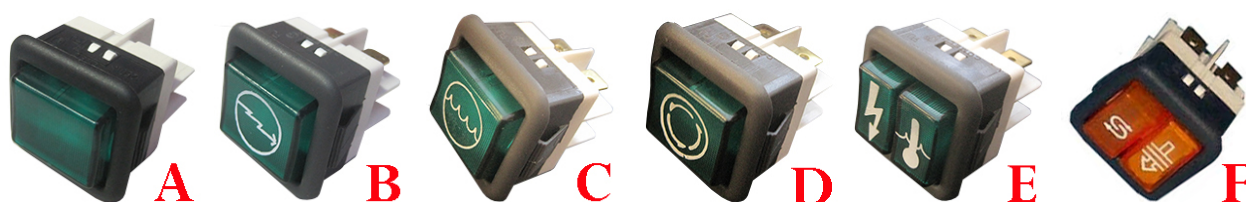

S&P CODE	TYPE	DIMENSIONI DIMENSIONS	V	COLORE COLOR	S&P CODE	TYPE	DIMENSIONI DIMENSIONS	V	COLORE COLOR
1104174	A	25X25mm	220V	VERDE GREEN	1104098	E	25X25mm	220V	VERDE GREEN
1104094	B	25X25mm	220V	VERDE GREEN	1104100	E	25X25mm	220V	BIANCO WHITE
1104136	B	25X25mm	220V	BIANCO WHITE	1104089	F	25X25mm	220V	ARANCIO ORANGE
1104095	C	25X25mm	220V	VERDE GREEN	1104142	B	25X25mm	12V	VERDE GREEN
1104138	C	25X25mm	220V	BIANCO WHITE	1104144	B	25X25mm	12V	BIANCO WHITE
1104015	C	25X25mm	220V	BIANCO WHITE	1104141	D	25X25mm	12V	VERDE GREEN
1104137	C	25X25mm	220V	BLU BLUE	1104145	D	25X25mm	12V	BIANCO WHITE
1104096	D	25X25mm	220V	VERDE GREEN	1104097	D	25X25mm	24V	VERDE GREEN
1104139	D	25X25mm	220V	BIANCO WHITE	1104099	D	25X25mm	24V	BIANCO WHITE
1104135	D	25X25mm	220V	BIANCO WHITE					



S&P CODE	TYPE	DIMENSIONI DIMENSIONS	V	COLORE COLOR	S&P CODE	TYPE	DIMENSIONI DIMENSIONS	V	COLORE COLOR
1104196	F	Foro Int. Ø=6mm	220V	VERDE GREEN	1104002	A	Ø=8mm	230V	ARANCIO ORANGE
1104259	E	Incasso Ø=7mm L=550mm	220V	ROSSO RED	1104037	B	Ø=8mm L=300mm	230V	VERDE GREEN
1104261	D	Foro Int. Ø=6mm L=300mm	230V	VERDE GREEN	1104215	C	Foro Int. Ø=6mm L=140mm	5V	VERDE GREEN
1104235	F	Foro Int. Ø=6mm	230V	ARANCIO ORANGE	1104102	D	Foro Int. Ø=6mm L=300mm	24V	VERDE GREEN
1104120	A	Ø=8mm	230V	FLUORESCENTE FLUORESCENT	1104184	B	Ø=8mm L=300mm	115V	VERDE GREEN
1104121	A	Ø=8mm	230V	BIANCO WHITE					

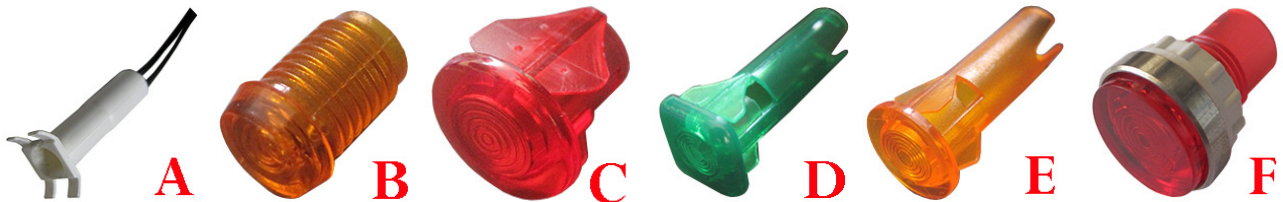

S&P CODE	TYPE	DIMENSIONI DIMENSIONS	V	COLORE COLOR	S&P CODE	TYPE	DIMENSIONI DIMENSIONS	COLORE COLOR
1104207	A	Foro Int. Ø=5mm L=250mm	230V	BIANCO WHITE	1104253	D	Ø=10mm 14X14mm	VERDE GREEN
1104104	B	Ø=6mm		ARANCIO ORANGE	1104186	D	Ø=10mm 14X14mm	VERDE CON LOGO GREEN WITH LOGO
1104198	B	Ø=6mm		VERDE GREEN	1104027	E	Ø=10mm	ARANCIO ORANGE
1104205	B	Ø=6mm		GIALLO YELLOW	1104038	F	Ø=12mm	VERDE GREEN
1104260	C	Ø=10mm		ROSSO RED	1104036	F	Ø=12mm	ROSSO RED
1104091	D	Ø=10mm 12X12mm		ARANCIO ORANGE	1104151	F	Ø=12mm	ARANCIO ORANGE
1104185	D	Ø=10mm 14X14mm		ARANCIO CON LOGO ORANGE WITH LOGO				

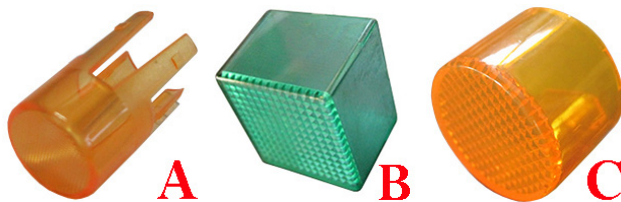



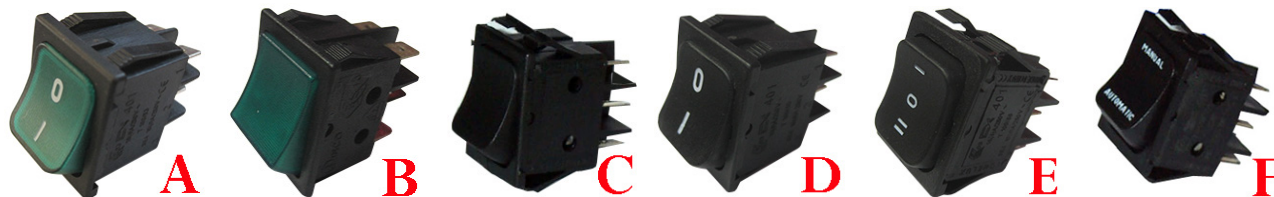

S&P CODE	TYPE	DIMENSIONI DIMENSIONS	COLORE COLOR	S&P CODE	TYPE	DIMENSIONI DIMENSIONS	COLORE COLOR
1104276	A	Ø=16mm	ARANCIO ORANGE	1104119	B	23X23mm	VERDE GREEN
1104238	A	Ø=16mm	VERDE GREEN	1104116	C	Ø=23mm	ARANCIO ORANGE
1104210	A	Ø=16mm	BLU BLUE	1104117	C	Ø=23mm	VERDE GREEN
1104118	B	23X23mm	ARANCIO ORANGE				

INTERRUTTORI / SWITCHES

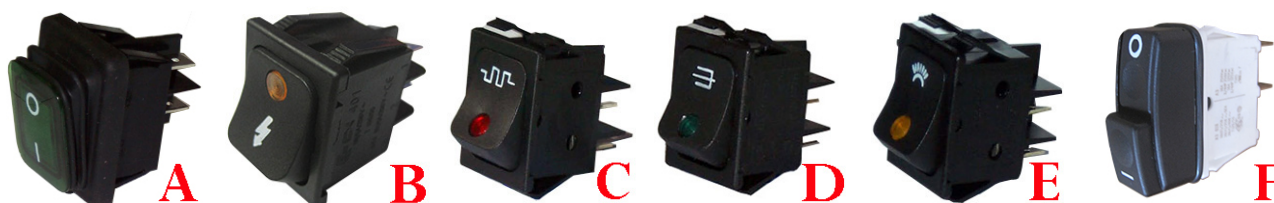

S&P CODE	TYPE	DIMENSIONI DIMENSIONS	POLI POLES	V	COLORE COLOR	S&P CODE	TYPE	DIMENSIONI DIMENSIONS	POLI POLES	V	COLORE COLOR
1105205	C	22X28mm	4	230V	NERO BLACK	1105198	A	22X30mm	4	230V 380V	VERDE GREEN
1105204	C	22X28mm	6	230V	NERO BLACK	1105345	A	22X30mm	5	230V	BLU BLUE
1105224	C	22X28mm	4	230V	BIANCO WHITE	1105045	A	22X30mm	4	230V	NON LUMINOSO NERO BLACK SWITCH NOT LUMINOUS
1105201	F	22X28mm	6	230V	NERO BLACK	1105066	D	13X20mm	4	250V	NERO BLACK
1105008	A	22X30mm	4	230V	VERDE GREEN	1105045	D	22X30mm	4	250V	NERO BLACK
1105007	A	22X30mm	6	230V	VERDE GREEN	1105178	E	22X28mm	6	250V	NERO BLACK
1105006	A	22X30mm	4	230V	ROSSO RED	1105335	B	22X30mm	6	24V	VERDE GREEN
1105044	A	22X30mm	4	230V	ARANCIO ORANGE						



S&P CODE	TYPE	DIMENSIONI DIMENSIONS	POLI POLES	V	COLORE COLOR	S&P CODE	TYPE	DIMENSIONI DIMENSIONS	POLI POLES	V	COLORE COLOR
1105217	A	22X28mm	4	230V	VERDE GREEN	1105200	E	22X28mm	4	230V 380V	ARANCIO ORANGE
1105246	A	22X28mm	4	230V	ARANCIO ORANGE	1105001	B	22X30mm	4	250V	
1105247	A	22X28mm	4	230V	ROSSO RED	1105002	B	22X30mm	4	250V	
1105243	A	22X28mm	4	230V	NERO NON LUMINOSO BLACK SWITCH NOT LUMINOUS	1105003	B	22X30mm	4	250V	
1105196	C	22X28mm	4	230V 380V	ROSSO RED	1105046	B	22X30mm	4	250V	
1105199	D	22X28mm	4	230V 380V	VERDE GREEN	1105405	F	11X27mm	2	250V	NERO BLACK

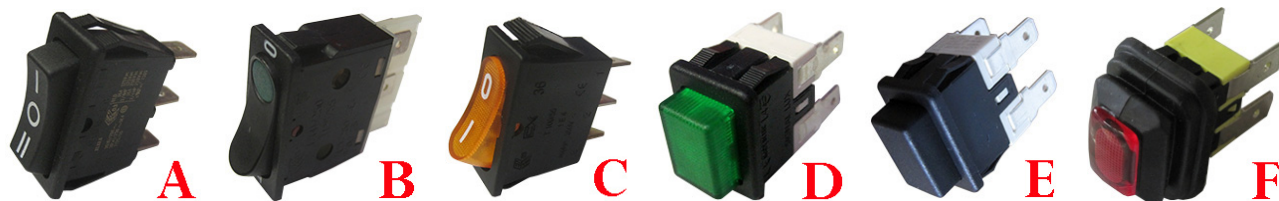

S&P CODE	TYPE	DIMENSIONI DIMENSIONS	POLI POLES	V	COLORE COLOR	S&P CODE	TYPE	DIMENSIONI DIMENSIONS	POLI POLES	V	COLORE COLOR
1105049	A	11X27mm	3	250V	NERO BLACK	1105319	D	13X20mm	4	250V	VERDE GREEN
1105256	B	12X35mm	4	250V	VERDE GREEN	1105239	E	13X20mm	4	250V	NERO BLACK
1105185	C	11X27mm	3	250V	ARANCIO ORANGE	1105324	F	13X20mm	4	250V	VERDE GREEN
1105375	C	11X27mm	3	250V	NERO BLACK	1105328	F	13X20mm	4	250V	ROSSO RED



S&P CODE	TYPE	DIMENSIONI DIMENSIONS	POLI POLES	V	COLORE COLOR	S&P CODE	TYPE	DIMENSIONI DIMENSIONS	POLI POLES	V	COLORE COLOR
1105055	A	13X20mm	4	230 V	INTERRUTTORE ACQUA WATER SWITCH	1105288	D	22X30mm	4	250 V	ROSSO-VERDE RED- GREEN
1105056	A	13X20mm	4	230 V	PULSANTE ACQUA WATER PUSH-BUTTON	1105306	E	22X28mm	6	250 V	BIANCO-NERO WHITE-BLACK
1105057	B	13X20mm	4	230 V	INTER. NERO BLACK SWITCH	1105325	F	21X43mm	2	240 V	VERDE-ROSSO GREEN- RED
1105053	C	22X30mm	4	250 V	LUMINOSO LUMINOUS	1105320	G	34X36mm	6	15V	BIANCO WHITE



S&P CODE	TYPE	DIMENSIONI DIMENSIONS	POLI POLES	V	COLORE COLOR	S&P CODE	TYPE	DIMENSIONI DIMENSIONS	POLI POLES	V	COLORE COLOR
1105033	A	Ø=25mm	4	230V	ROSSO RED	1105343	C	Ø=25mm	4	230V	VERDE GREEN
1105034	A	Ø=25mm	4	230V	ARANCIO ORANGE	1105037	D	CAPPuccio PROTEZIONE RETTANGOLARE RECTANGULAR PROTECTION CAP			
1105035	A	Ø=25mm	4	230V	VERDE GREEN	1105038	E	CAPPuccio PROTEZIONE TONDO ROUND PROTECTION CAP			
1105248	B	Ø=25mm	4	230V	ARANCIO ORANGE	1105337	F	CAPPuccio PROTEZIONE QUADRATO SQUARE PROTECTION CAP			

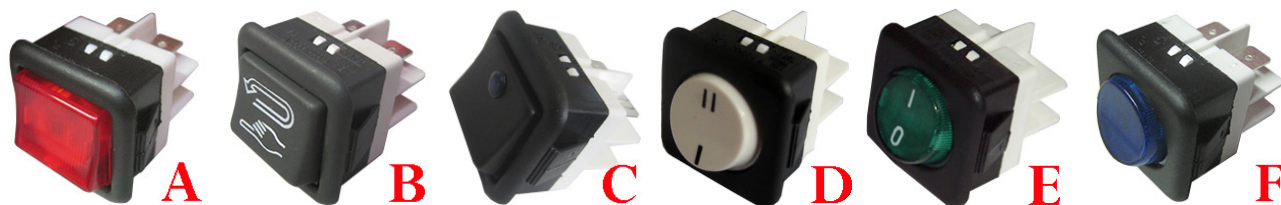

S&P CODE	TYPE	DIMENSIONI DIMENSIONS	POLI POLES	V	COLORE COLOR	S&P CODE	TYPE	DIMENSIONI DIMENSIONS	POLI POLES	V	COLORE COLOR
1105235	A	25X25mm	4	220V	ROSSO RED	1105179	B	25X25mm	6	250V	
1105236	A	25X25mm	4	220V	ARANCIO ORANGE	1105183	B	25X25mm	6	250V	
1105237	A	25X25mm	4	220V	VERDE GREEN	1105357	C	25X25mm	4	250V	BLU BLUE
1105238	A	25X25mm	4	220V	BLU BLUE	1105346	D	25X25mm	2	250V	BIANCO WHITE
1105301	F	25X25mm	4	230V	BLU BLUE	1105347	D	25X25mm	6	250V	BIANCO WHITE
1105166	B	25X25mm	6	250V		1105308	E	25X25mm	4	250V	VERDE GREEN
1105180	B	25X25mm	6	250V							

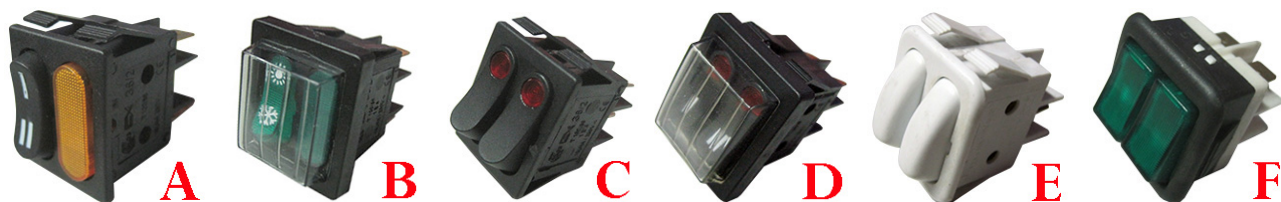

S&P CODE	TYPE	DIMENSIONI DIMENSIONS	POLI POLES	V	COLORE COLOR	S&P CODE	TYPE	DIMENSIONI DIMENSIONS	POLI POLES	V	COLORE COLOR
1105047	A	22X28mm	4	250V	ARANCIO ORANGE	1105206	D	22X28mm	6	230V 380V	ROSSO RED
1105186	A	22X28mm	4	250V	BIANCO WHITE	1105292	E	22X28mm	4	250V	BIANCO WHITE
1105101	B	22X28mm	5	250V	VERDE GREEN	1105254	F	25X25mm	6	250V	VERDE GREEN
1105050	C	22X28mm	6	250V	ROSSO RED						

PULSANTI / PUSH-BUTTON

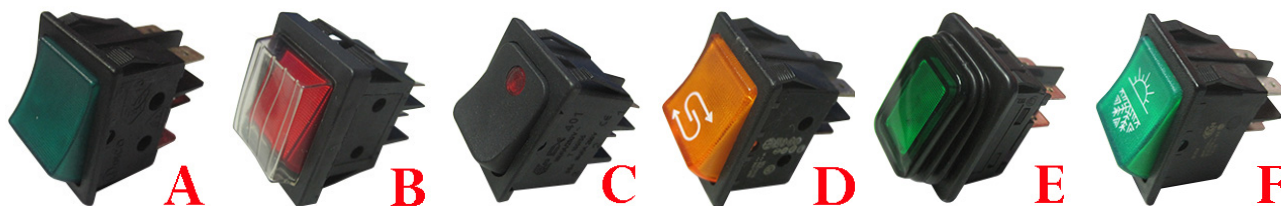

S&P CODE	TYPE	DIMENSIONI DIMENSIONS	POLI POLES	V	COLORE COLOR	S&P CODE	TYPE	DIMENSIONI DIMENSIONS	POLI POLES	V	COLORE COLOR
1108002	A	22X30mm	4	230V	GIALLO YELLOW	1108141	E	22X30mm	4	230V	VERDE GREEN
1108032	A	22X30mm	4	230V	VERDE GREEN	1108025	F	22X30mm	4	230V	
1108136	A	22X30mm	5	230V	GIALLO YELLOW	1108072	F	22X30mm	6	230V	
1108134	A	22X30mm	6	230V	VERDE GREEN	1108079	F	22X30mm	4	230V	
1108145	A	22X30mm	2	230V	NON LUMINOSO NERO BLACK SWITCH NOT LUMINOUS	1108083	F	22X30mm	2	230V	
1108076	B	22X30mm	3	230V	ROSSO RED	1108080	F	22X30mm	4	230V	
1108143	C	22X30mm	4	230V	ROSSO RED	1108146	F	22X30mm	6	230V	
1108185	D	22X30mm	4	230V	ARANCIO ORANGE						

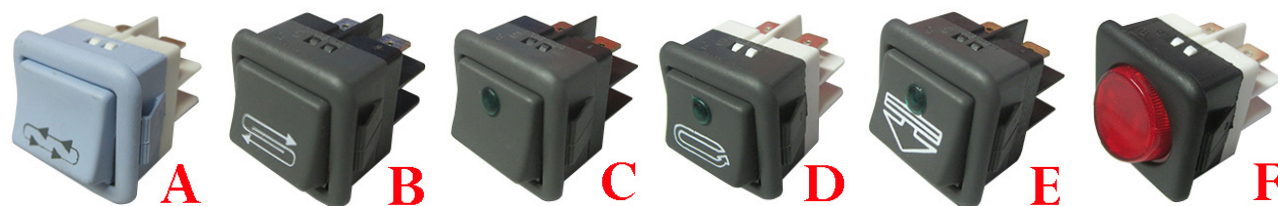

S&P CODE	TYPE	DIMENSIONI DIMENSIONS	POLI POLES	V	COLORE COLOR	S&P CODE	TYPE	DIMENSIONI DIMENSIONS	POLI POLES	V	COLORE COLOR
1108020	A	25X25mm	4	230V	AZZURRO BLUE	1108071	C	25X25mm	6	230V	VERDE GREEN
1108075	A	25X25mm	4	230V	GRIGIO GREY	1108078	D	25X25mm	6	230V	VERDE GREEN
1108084	A	25X25mm	6	230V	GRIGIO CHIARO LIGHT GREY	1108061	E	25X25mm	6	230V	VERDE GREEN
1108081	B	25X25mm	4	230V	AZZURRO BLUE	1108122	F	25X25mm	4	230V	ROSSO RED
1108082	B	25X25mm	4	230V	GRIGIO GREY	1108074	C	25X25mm	6	24V	VERDE GREEN



S&P CODE	TYPE	DIMENSIONI DIMENSIONS	POLI POLES	V	COLORE COLOR	S&P CODE	TYPE	DIMENSIONI DIMENSIONS	POLI POLES	V	COLORE COLOR
1108070	A	25X25mm	4	230V	ARANCIO ORANGE	1108005	E	12X34mm	4	250V	ARANCIO ORANGE
1108073	B	25X25mm	6	230V	BIANCO WHITE	1108178	F	Ø=15mm	2	250V	NERO BLACK
1108077	B	25X25mm	6	230V	VERDE GREEN	1108191	F	Ø=15mm	2	250V	NERO BLACK
1108040	C	25X25mm	4	230V	ARANCIO ORANGE	1108039	B	25X25mm	6	24V	VERDE GREEN
1108004	D	12X34mm	4	250V	ARANCIO ORANGE	1108049	C	25X25mm	4	24V	ARANCIO ORANGE

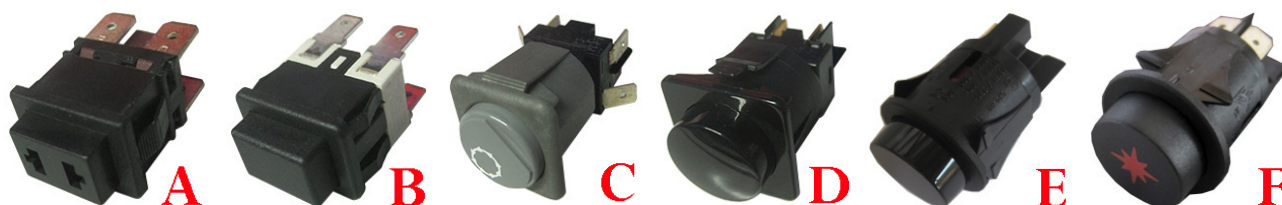

S&P CODE	TYPE	DIMENSIONI DIMENSIONS	POLI POLES	V	COLORE COLOR	S&P CODE	TYPE	DIMENSIONI DIMENSIONS	POLI POLES	V	COLORE COLOR
1108008	A	13X20mm	4	230V	NERO BLACK	1108033	D	25X25mm	4	230V	NERO BLACK
1108097	B	13X20mm	4	230V	NERO BLACK	1108158	E	Ø=25mm		250V	NERO BLACK
1108041	C	25X25mm	6	230V	GRIGIO GREY	1108159	F	Ø=25mm		250V	NERO BLACK

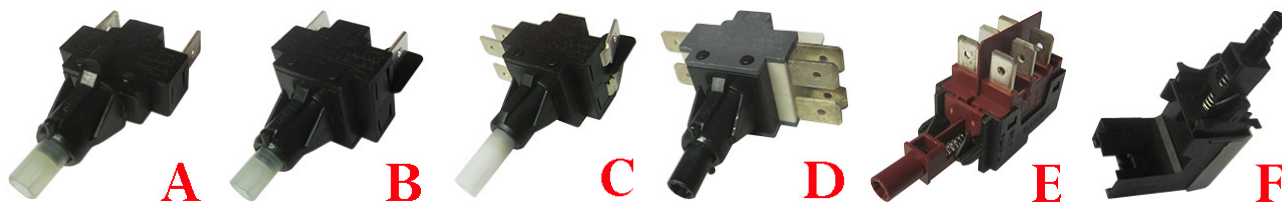

S&P CODE	TYPE	DIMENSIONI DIMENSIONS	POLI POLES	V	S&P CODE	TYPE	DIMENSIONI DIMENSIONS	POLI POLES	V
1108057	A	19X24mm	2	230V	1108067	D	19X24mm	6	230V
1108058	B	19X24mm	4	230V	1108068	E	19X30mm	6	230V
1108123	C	19X24mm	6	230V	1105394	F	18X29mm		20V

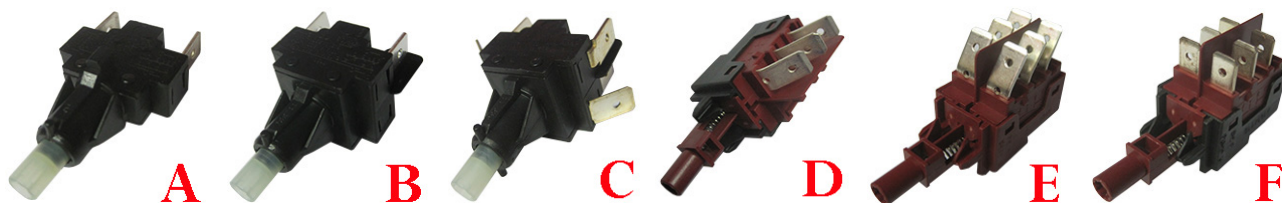

S&P CODE	TYPE	DIMENSIONI DIMENSIONS	POLI POLES	V	S&P CODE	TYPE	DIMENSIONI DIMENSIONS	POLI POLES	V
1105117	A	19X24mm	2	230V	1105389	D	19X30mm	3	230V
1105154	B	19X24mm	4	230V	1105245	E	19X30mm	6	230V
1105155	C	19X24mm	6	230V	1105170	F	19X30mm	6	230V
1105169	C	19X24mm	6 ORIZZONTALI 6 HORIZONTAL	230V					

TASTI / BUTTON

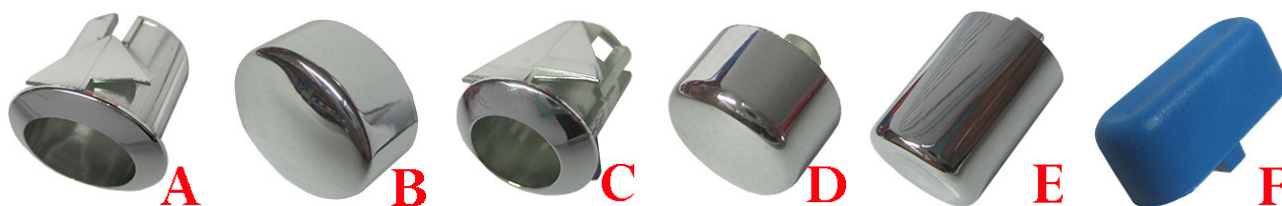

S&P CODE	TYPE	DIMENSIONI DIMENSIONS	COLORE COLOR	S&P CODE	TYPE	DIMENSIONI DIMENSIONS	COLORE COLOR
1105145	A	Ø=16mm	NERO BLACK	1105149	C	Ø=16mm	NERO BLACK
1105147	A	Ø=16mm	CROMATO CHROMIUM	1105151	C	Ø=16mm	CROMATO CHROMIUM
1105401	A	Ø=16mm	ARGENTO SILVER	1105297	C	Ø=16mm	CROMATO CHROMIUM
1105388	A	Ø=16mm	GRIGIO GREY	1105177	D	Ø=12mm	GRIGIO GREY
1105146	B	13X17mm	NERO BLACK	1105150	D	Ø=12mm	NERO BLACK
1105402	B	13X17mm	NERO OPACO MATT BLACK	1105152	D	Ø=12mm	CROMATO CHROMIUM
1105148	B	13X17mm	CROMATO CHROMIUM	1105296	D	Ø=12mm	CROMATO CHROMIUM
1108181	B	13X17mm	GRIGIO GREY	1105210	E	Ø=12mm	CROMATO CHROMIUM
1105176	C	Ø=16mm	GRIGIO GREY	1108116	F	10X25mm	BLU BLUE

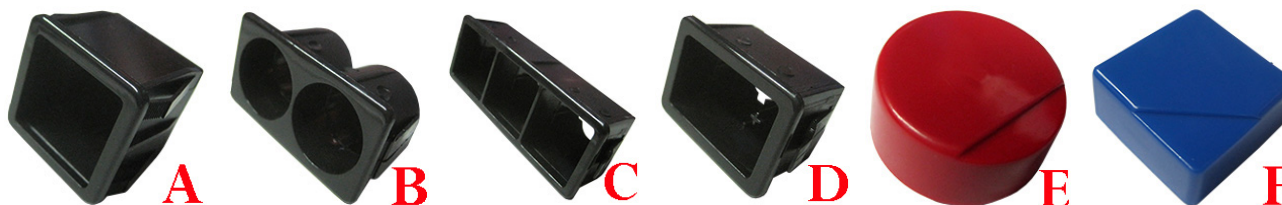

S&P CODE	TYPE	DIMENSIONI DIMENSIONS	COLORE COLOR	S&P CODE	TYPE	DIMENSIONI DIMENSIONS	COLORE COLOR
1105118	A	TASTO TONDO ROUND BUTTON	NERO BLACK	1105127	E	Ø=23mm	VERDE GREEN
1105119	A	TASTO QUADRATO SQUARE BUTTON	NERO BLACK	1105128	E	Ø=23mm	GIALLO YELLOW
1105120	B	TASTO TONDO ROUND BUTTON	NERO BLACK	1105175	E	Ø=23mm	GRIGIO GREY
1105121	B	TASTO QUADRATO SQUARE BUTTON	NERO BLACK	1105134	F	23X23mm	NERO BLACK
1105122	C	TASTO TONDO ROUND BUTTON	NERO BLACK	1105135	F	23X23mm	ROSSO RED
1105123	C	TASTO QUADRATO SQUARE BUTTON	NERO BLACK	1105136	F	23X23mm	BLU BLUE
1105226	D	TASTO RETTANGOLARE RECTANGULAR BUTTON	NERO BLACK	1105137	F	23X23mm	VERDE GREEN
1105124	F	Ø=23mm	NERO BLACK	1105138	F	23X23mm	GIALLO YELLOW
1105125	E	Ø=23mm	ROSSO RED				
1105126	E	Ø=23mm	BLU BLUE				

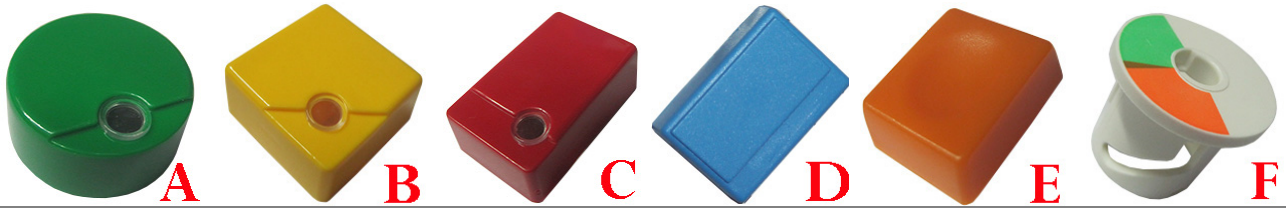

S&P CODE	TYPE	DIMENSIONI DIMENSIONS	COLORE COLOR	S&P CODE	TYPE	DIMENSIONI DIMENSIONS	COLORE COLOR
1105129	A	Ø=23mm	NERO BLACK	1105227	C	18X30mm	NERO BLACK
1105130	A	Ø=23mm	ROSSO RED	1105228	C	18X30mm	VERDE GREEN
1105131	A	Ø=23mm	BLU BLUE	1105229	C	18X30mm	ROSSO RED
1105132	A	Ø=23mm	VERDE GREEN	1105230	C	18X30mm	BLU BLUE
1105133	A	Ø=23mm	GIALLO YELLOW	1105231	C	18X30mm	GIALLO YELLOW
1105139	B	23X23mm	NERO BLACK	1105294	D	21X31mm	BLU BLUE
1105140	B	23X23mm	ROSSO RED	1108130	E	19X25mm	ARANCIO ORANGE
1105141	B	23X23mm	BLU BLUE	1105144	F	VERDE/ARANCIO PER DOMINO TONDO/QUADRO GREEN/ORANGE FOR ROUND/SQUARE DOMINO	
1105142	B	23X23mm	VERDE GREEN	1105232	F	VERDE/ARANCIO PER DOMINO RETTANGOLARE GREEN/ORANGE FOR RECTANGUL. DOMINO	
1105143	B	23X23mm	GIALLO YELLOW				



S&P CODE	TYPE	DIMENSIONI DIMENSIONS	COLORE COLOR	S&P CODE	TYPE	DIMENSIONI DIMENSIONS	COLORE COLOR
1105251	A	Ø=21mm	NERO BLACK	1108173	E	Ø=25mm	GRIGIO GREY
1108092	B	Ø=21mm	NERO BLACK	1108179	E	Ø=23mm	ROSSO RED
1105252	C	Ø=21mm	BLU BLUE	1108118	E	Ø=25mm	VERDE GREEN
1108170	D	Ø=25mm	GRIGIO GREY	1108174	F	Ø=25mm	GRIGIO GREY
1108135	D	Ø=25mm	ARANCIO ORANGE	1108121	F	Ø=25mm	VERDE GREEN



S&P CODE	TYPE	DIMENSIONI DIMENSIONS	COLORE COLOR	S&P CODE	TYPE	DIMENSIONI DIMENSIONS	COLORE COLOR
1108175	A	Ø=25mm	GRIGIO GREY	1108182	D	Ø=25mm	ARANCIO ORANGE
1108119	A	Ø=25mm	BLU BLUE	1108189	D	Ø=23mm	GRIGIO GREY
1108176	B	Ø=25mm	GRIGIO GREY	1108111	E	Ø=25mm	GRIGIO GREY
1108177	C	Ø=25mm	GRIGIO GREY	1108117	E	Ø=25mm	ARANCIO ORANGE
1108165	C	Ø=25mm	ARANCIO ORANGE	1108042	F	Ø=23mm	VERDE GREEN



S&P CODE	TYPE	DIMENSIONI DIMENSIONS	COLORE COLOR	S&P CODE	TYPE	DIMENSIONI DIMENSIONS	COLORE COLOR
1105376	A	Ø=25mm	GIALLO YELLOW	1105341	D	Ø=21mm	GRIGIO GREY
1108093	A	Ø=25mm	LILLA	1108132	E	SUPPORTO TASTO DOMINO Ø=25mm SUPPORT BUTTON DOMINO Ø=25mm	
1105377	B	Ø=21mm	BLU BLUE	1108043	F	Ø=23mm	BLU BLUE
1105342	C	Ø=25mm	GRIGIO GREY				

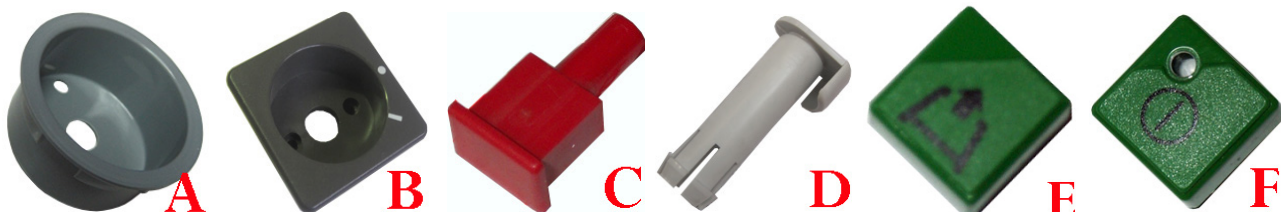

S&P CODE	TYPE	COLORE COLOR	S&P CODE	TYPE	DIMENSIONI DIMENSIONS	COLORE COLOR
4115155	A	GRIGIO GREY	1108019	D		GRIGIO GREY
4120347	B	GRIGIO GREY	1105272	E	23X23mm	VERDE GREEN
1108059	C	ROSSO RED	1105273	F	23X23mm	VERDE GREEN

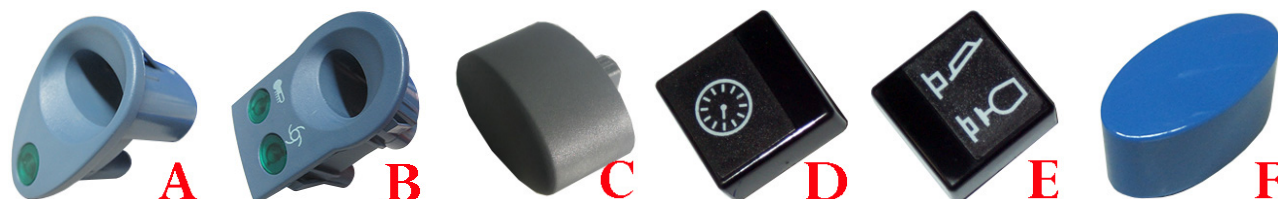

S&P CODE	TYPE	DIMENSIONI DIMENSIONS	COLORE COLOR	S&P CODE	TYPE	DIMENSIONI DIMENSIONS	COLORE COLOR
3108150	A	PER TASTO 13X23mm FOR BUTTON 13X23mm	BLU BLUE	3108145	C	13X23mm	
3108154	B	PER TASTO 13X23mm FOR BUTTON 13X23mm	BLU BLUE	3108146	C	13X23mm	
3108149	C	13X23mm	GRIGIO GREY	3108147	C	13X32mm	
3108142	C	13X23mm		1105274	D	23X23mm	NERO BLACK
3108143	C	13X32mm		1108038	E	23X23mm	NERO BLACK
3108155	C	13X23mm		1108110	F	11X21mm	BLU BLUE
3108144	C	13X23mm					



S&P CODE	TYPE	DIMENSIONI DIMENSIONS	COLORE COLOR	S&P CODE	TYPE	DIMENSIONI DIMENSIONS	COLORE COLOR
1104251	A	Ø=10mm	NERO BLACK	1105362	D	Ø=20mm	ROSSO RED
1104252	B	Ø=10mm	NERO BLACK	1108094	E	9X61mm	GRIGIO GREY
1108171	C	ØFiletto=4mm Ø=22mm	NERO BLACK	1108095	F	27X80mm	BIANCO WHITE

1105051 INTERRUTT
ORE COM. GR. CD /
SWITCH COM. GR. CD
34030006*:
RANCILIO SPA



1115011 COMMUTAT
ORE 0-1 /
COMMUTATOR 0-1
34030026:
RANCILIO SPA



1115002 COMMUTAT
ORE 2-0-1 LT /
COMMUTATOR 2-0-1
LT
34030027:
RANCILIO SPA



1105300 INTERR.
ROT. BIPOLARE /
BIPOLAR SWITCH
S000INA09QQQ:
MAZZER LUIGI SRL



1105275 INTERR.
ROT. TRIPOLARE /
3POLAR SWITCH
S000INA04AQQ:
MAZZER LUIGI SRL



1105290 INTERR.
ROT. BIPOL. + FASE
AUS. /
BIPOLAR SWITCH.
S000INA13QQQ:
MAZZER LUIGI SRL



1105051 INTERRUTT
ORE COM. GR. CD /
SWITCH COM. GR. CD
34030006*:
RANCILIO SPA



1115031 INTERRUTT
ORE ROT. TRIPOLARE
+ FASE AUSILIARIA /
ROTARY SWITCH 4 - 3
OPERATING
POSITIONS
S000INA10AQQ:
MAZZER LUIGI SRL



1105213 INTERRUTT
ORE CAFFE' C6/S C8/S /
"SWITCH ""COFFE""
C6/S C8/S"
10705414:
RANCILIO SPA
10705368:
RANCILIO SPA

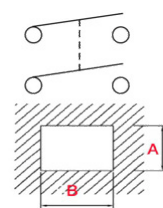
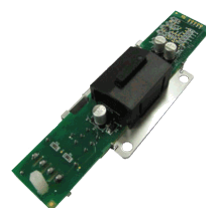

1105214 PULSANTIE
RA ACQUA C6 /
WATER PUSH-BUTTON
C6
10705369:
RANCILIO SPA

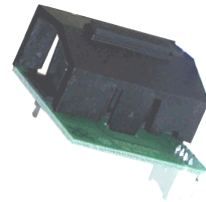

1105353 INTERRUTT
ORE ACQUA S /
KEYPAD UNIT
RANCILIO 1 BUTTON
10705366:
RANCILIO SPA

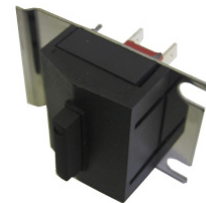

1105112 FASTON
FEMMINA 6,3X0,8
SEZ.1-2,5 OTTONE
STAGNATO /
FEMALE FASTON
6,3X0,8X SEZ. 1-2,5
TINNED BRASS

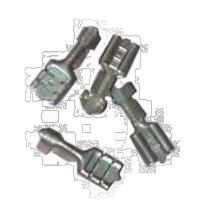

1105113 FASTON
MASCHIO 6,3X0,8
SEZ.1-2,5 OTTONE
STAGNATO /
MALE FASTON
6,3X0,8X SEZ. 1-2,5
TINNED BRASS

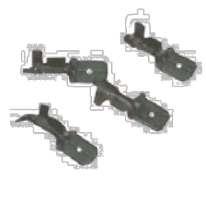

1105114 COPRIFAST
ON FEMMINA 6,3X0,8 /
FEMALE
COVERFASTON 6,3X0,8



1105115 COPRIFAST
ON MASCHIO 6,3X0,8 /
MALE COVERFASTON
6,3X0,8

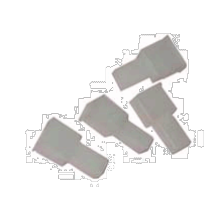

1105407 FASTON
FEMMINA
PREISOLATO
RINFORZATO 6,3X0,8
SEZIONE 2,5 OTTONE
STAGNATO /
PRE-INSULATING
REINFORCED FEMALE
FASTON 6,3x0,8
SECTION 2.5 TINNED
BRASS

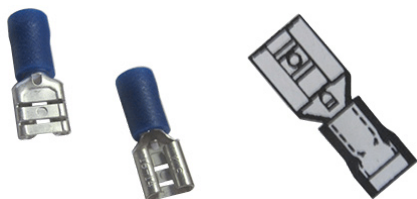

1105408 FASTON
MASCIO
PREISOLATO
RINFORZATO 6,3X0,8
SEZIONE 2,5 OTTONE
STAGNATO /
MALE FASTON 6,3x0,8
REINFORCED PRE-
INSULATING SECTION
2.5 TINNED BRASS

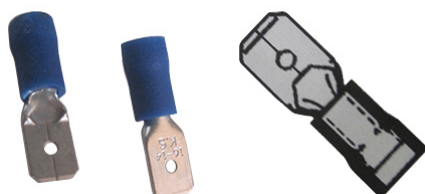

1105409 FASTON
FEMMINA
TOTALMENTE
RINFORZATO
PREISOLATO 6,3X0,8
SEZ.2,5 OTTONE
STAGNATO /
FASTON FEMALE
FULLY REINFORCED
PRE-INSULATING
6,3x0,8 SEZ.2,5 TINNED
BRASS



1105410 CAPOCORD
A A FORCELLA
PREISOLATO 8,1X0,8
FORO 5,3 SEZIONE 2,5 /
TERMINALS FORK
PRE-INSULATING
8,1X0,8 HOLE SECTION
5.3 2.5



1108178 PULSANTI
MARCIA /
START BUTTON
EB076M: OBEL SRL



1108191 PULSANTI
DI REGOLAZIONE
(NERO) 0.7A 250V /
BLACK SINGLE POLE
PUSH-BUTTON 0.7A
250V
DF34: OBEL SRL



Ø=15mm

TUBI FLEX INOX / STAINLESS STEEL FLEX PIPES



CODICE S&P S&P CODE	DIMENSIONI DIMENSIONS	TIPO TYPE	CODICE S&P S&P CODE	DIMENSIONI DIMENSIONS	TIPO TYPE
2110004	FF 3/8 L=450mm	A CONICO A CONICAL	2110028	FF 3/8 L=1800mm	A CONICO A CONICAL
2110032	FF 3/8 L=500mm	A CONICO A CONICAL	2110029	FF 3/8 L=2000mm	A CONICO A CONICAL
2110053	FF 3/8 L=600mm	A CONICO A CONICAL	2110036	FF 1/8 L=370mm	B PIANO B FLAT
2110011	FF 3/8 L=800mm	A CONICO A CONICAL	2110048	FF 1/4 L=280mm	B PIANO B FLAT
2110005	FF 3/8 L=1000mm	A CONICO A CONICAL	2110106	FF 1/4 L=500mm	B PIANO B FLAT
2110012	FF 3/8 L=1200mm	A CONICO A CONICAL	2110167	FF 3/8 L=280mm	B PIANO B FLAT
2110006	FF 3/8 L=1500mm	A CONICO A CONICAL	2110016	FF 3/8 L=800mm	B PIANO B FLAT
2110055	FF 3/8 L=1600mm	A CONICO A CONICAL			



CODICE S&P S&P CODE	DIMENSIONI DIMENSIONS	TIPO TYPE	CODICE S&P S&P CODE	DIMENSIONI DIMENSIONS	TIPO TYPE
2110043	FC-F 3/8 L=500mm	A CONICO A CONICAL	2100024	FC-F 3/8 L=1000mm	B PIANO B FLAT
2110015	FC-F 3/8 L=1000mm	A CONICO A CONICAL	2110042	FC-F 3/8 L=1500mm	B PIANO B FLAT
2110014	FC-F 3/8 L=1500mm	A CONICO A CONICAL	2110007	FC-F 3/8 L=2000mm	B PIANO B FLAT
2110063	FC-F 3/8 L=1600mm	A CONICO A CONICAL	2110056	FC-F 3/4 L=1000mm	B PIANO B FLAT
2110013	FC-F 3/8 L=2000mm	A CONICO A CONICAL	2110050	FC-F 3/4 L=1500mm	B PIANO B FLAT
2110025	FC-F 3/8 L=370mm	B PIANO B FLAT	2110147	FC-F 3/4 L=2000mm	B PIANO B FLAT
2110047	FC-F 3/8 L=500mm	B PIANO B FLAT	2110096	FC 3/4 PIANO-FLAT F 3/8 CONICO-CONICAL L=1000mm	C PIANO / FLAT - CONICO / CONICAL



CODICE S&P S&P CODE	DIMENSIONI DIMENSIONS	CODICE S&P S&P CODE	DIMENSIONI DIMENSIONS
2110107	FF 1/2 L=1000mm PIANO - FLAT	2110105	FF 1/2 L=2000mm PIANO - FLAT
2110108	FF 1/2 L=1200mm PIANO - FLAT	2110180	FF 1/2 L=8500mm PIANO - FLAT
2110035	FF 1/2 L=1500mm PIANO - FLAT	2110179	FF 1/2 L=16000mm PIANO - FLAT



L
VIPLATO
PLASTIC COVERED

CODICE S&P S&P CODE	DIMENSIONI DIMENSIONS
2110045	F 3/8 PIANO/PLANE - M 1/2 L=1500mm



L

CODICE S&P S&P CODE	DIMENSIONI DIMENSIONS
2110095	F 3/4 PIANO/PLANE - F3/8 CONICO/CONICAL L=500mm

TUBI DI SCARICO / DRAIN PIPES



L

CODICE S&P S&P CODE	DIMENSIONI DIMENSIONS	CODICE S&P S&P CODE	DIMENSIONI DIMENSIONS
2109001	A=21mm B=19mm L=1500mm	2109063	A=31mm B=19mm L=2000mm
2109002	A=28mm B=24mm L=1500mm	2109023	A=35mm B=28mm L=3000mm
2109012	A=30mm B=24mm L=2000mm	2109003	A=35mm B=32mm L=2000mm
		2109062	A=41mm B=35mm L=2000mm



L

CODICE S&P S&P CODE	DIMENSIONI DIMENSIONS	CODICE S&P S&P CODE	DIMENSIONI DIMENSIONS
2109011	A=21mm B=19mm L=1500mm	2109066	A=31mm L=1500mm
2109039	A=21mm L=2000mm	2109052	A=40mm L=1500mm
2109036	A=22mm B=18mm L=2500mm	2109043	A=41mm B=32mm L=1600mm
2109037	A=22mm B=22mm L=1500mm	2109022	A=42mm L=2000mm
2109051	A=28mm B=20mm L=1800mm	2109065	A=47mm L=1500mm
2109004	A=28mm B=24mm L=1500mm	2109045	A=60mm B=45mm L=1500mm
2109059	A=19mm		

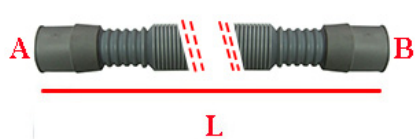

ESTENSIBILE - EXTENSIBLE

CODICE S&P S&P CODE	DIMENSIONI DIMENSIONS
2109009	A=21mm B=19mm L=600-2000mm
2109010	A=39mm B=24mm L=600-2000mm

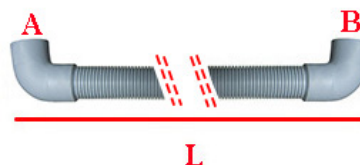

CODICE S&P S&P CODE	DIMENSIONI DIMENSIONS
2108317	A=20mm B=20mm L=350mm

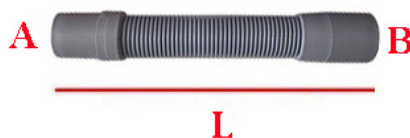

CODICE S&P S&P CODE	DIMENSIONI DIMENSIONS	CODICE S&P S&P CODE	DIMENSIONI DIMENSIONS
2109035	A=17mm B=17mm L=130mm	2109053	A=19mm B=19mm L=174mm
2108229	A=18mm B=21mm L=173mm	2109041	A=19mm B=19mm L=280mm
2108227	A=18mm B=22mm L=205mm	2108228	A=21mm B=21mm L=177mm

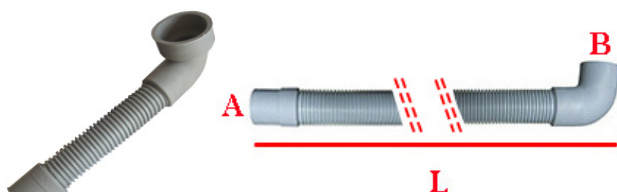

CODICE S&P S&P CODE	DIMENSIONI DIMENSIONS
2108333	A=33mm B=52mm L=260mm

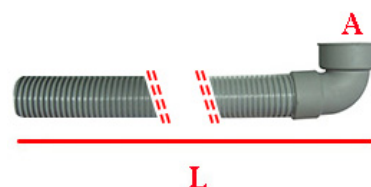

CODICE S&P S&P CODE	DIMENSIONI DIMENSIONS
2109030	A=51mm L=2000mm



**SPIRALATO
SPIRALLED**



**VENDITA AL METRO
SELLING AT METER**

CODICE S&P S&P CODE	DIMENSIONI DIMENSIONS	CODICE S&P S&P CODE	DIMENSIONI DIMENSIONS
2110185	Ø=12mm	2109025	Ø=18mm
2110003	Ø=14mm	2110082	Ø=20mm
2109024	Ø=16mm	2110174	Ø=35mm

TUBI / PIPES



PVC

VENDITA AL METRO
SELLING AT METER

CODICE S&P S&P CODE	DIMENSIONI DIMENSIONS	COLORE COLOR	CODICE S&P S&P CODE	DIMENSIONI DIMENSIONS	COLORE COLOR
2110091	Ø=4X6mm	TRASPARENTE TRASPARENT	2110092	Ø=5X7,5mm	TRASPARENTE TRASPARENT
2110170	Ø=4X6mm	ROSSO RED	2110083	Ø=8X12mm	TRASPARENTE TRASPARENT
2110171	Ø=4X6mm	VERDE GREEN	2109055	Ø=18X24mm	VERDE GREEN
2109026	Ø=4X7mm	TRASPARENTE TRASPARENT			



GOMMA
RUBBER

VENDITA AL METRO
SELLING AT METER

CODICE S&P S&P CODE	DIMENSIONI DIMENSIONS	COLORE COLOR	CODICE S&P S&P CODE	DIMENSIONI DIMENSIONS	COLORE COLOR
2110085	Ø=5X9mm	NERO BLACK	2109005	Ø=10X17mm	NERO - BLACK FOOD QUALITY
2110137	Ø=5X12mm	NERO BLACK	2110002	Ø=10X17mm	NERO BLACK
2110093	Ø=6X9mm	NERO BLACK	2110139	Ø=25X35mm	NERO BLACK
2110001	Ø=8X17mm	NERO - BLACK FOOD QUALITY			



TEFLON

VENDITA AL METRO
SELLING AT METER

CODICE S&P S&P CODE	DIMENSIONI DIMENSIONS	CODICE S&P S&P CODE	DIMENSIONI DIMENSIONS
2110079	Ø=3X5mm	2108130	Ø=6,3X9,5mm
2110080	Ø=4X6mm		



SILICONE

VENDITA AL METRO
SELLING AT METER

CODICE S&P S&P CODE	DIMENSIONI DIMENSIONS	CODICE S&P S&P CODE	DIMENSIONI DIMENSIONS
2110149	Ø=3X8mm	2110071	Ø=5X8mm
2110151	Ø=4X8mm	2110078	Ø=8X12mm



SANTOPRENE
SANTOPREN



VENDITA AL METRO
SELLING AT METER

CODICE S&P S&P CODE	DIMENSIONI DIMENSIONS	CODICE S&P S&P CODE	DIMENSIONI DIMENSIONS
1123022	Ø=4X7mm	1123027	Ø=6X9mm
2110150	Ø=4,8X8mm	2110148	Ø=6,2X10,5mm

2110207 TUBO
SPURGO /
DRAIN PIPE
01437:
LA SPAZIALE SPA



TERMOCOPPIE / THERMOCOUPLES



**GIUNTO UNIFICATO
UNIFIED SLEEVE**

**GIUNTO FILETTATO
THREADED SLEEVE**

S&P CODE	LUNGHEZZA L LENGHT L	FILETTO GIUNTO Ø THREAD Ø	TYPE	S&P CODE	LUNGHEZZA L LENGHT L	FILETTO GIUNTO Ø THREAD Ø	TYPE
4101101	320mm	Ø= 8X1	A	4101094	1200mm	Ø= 9X1	A
4101052	450mm	Ø= 8X1	A	4101089	1500mm	Ø= 9X1	A
4101090	600mm	Ø= 8X1	A	4101027	400mm	Ø= 11/32 ASA	A
4101085	850mm	Ø= 8X1	A				
4101091	1000mm	Ø= 8X1	A	4101106	320mm	Ø= 8X1	B
4101086	1200mm	Ø= 8X1	A	4101104	600mm	Ø= 8X1	B
4101071	1500mm	Ø= 8X1	A	4101040	1000mm	Ø= 8X1	B
4101016	320mm	Ø= 9X1	A	4101095	1200mm	Ø= 8X1	B
4101030	400mm	Ø= 9X1	A	4101039	1500mm	Ø= 8X1	B
4101004	500mm	Ø= 9X1	A	4101020	320mm	Ø= 9X1	B
4101067	500mm	Ø= 9X1 NICHELATA	A	4101055	500mm	Ø= 9X1	B
4101007	600mm	Ø= 9X1	A	4101021	600mm	Ø= 9X1	B
4101005	750mm	Ø= 9X1	A	4101033	1000mm	Ø= 9X1	B
4101088	850mm	Ø= 9X1	A	4101061	1200mm	Ø= 9X1	B
4101008	1000mm	Ø= 9X1	A	4101056	1500mm	Ø= 9X1	B

TERMOCOPPIE INTERROTTE/ THERMOCOUPLES INTERRUPTED

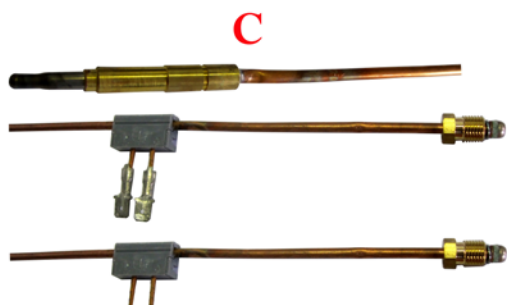

GIUNTO UNIFICATO - INTERROTTA
UNIFIED SLEEVE - INTERRUPTED

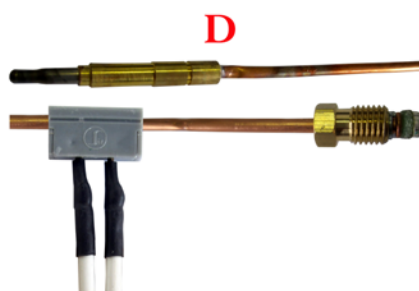

GIUNTO UNIFICATO - INTERROTTA
CABLATA
UNIFIED SLEEVE - INTERRUPTED
CABLED

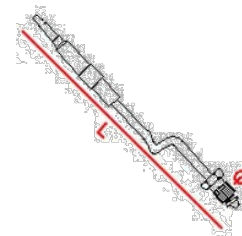

S&P CODE	LUNGHEZZA L LENGHT L	FILETTO GIUNTO Ø THREAD Ø	FASTON	TYPE	S&P CODE	LUNGHEZZA L LENGHT L	FILETTO GIUNTO Ø THREAD Ø	TYPE
4101023	600mm	Ø= 9X1	SI - YES	C	4101110	600mm	Ø= 9X1	D
4101077	600mm	Ø= 9X1	NO	C	4101087	1000mm	Ø= 9X1	D
4101010	1000mm	Ø= 9X1	NO	C	4101108	1000mm	Ø= 9X1	D

TERMOCOPPIE UNIVERSALI / UNIVERSAL THERMOCOUPLES



S&P CODE	LUNGHEZZA L LENGHT L	FILETTO GIUNTO Ø THREAD Ø	TYPE
4101019	900mm	UNIVERSALE	E
4101025	1200mm	UNIVERSALE	E
4101100	1500mm	UNIVERSALE	E



S&P CODE	LUNGHEZZA L LENGHT L	FILETTO GIUNTO Ø THREAD Ø	TYPE
4101009	900mm	UNIVERSALE	F
4101018	1200mm	UNIVERSALE	F

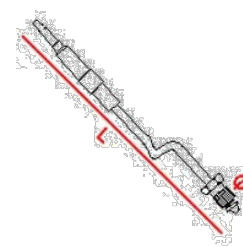

TERMOCOPPIE SPECIALI / SPECIAL THERMOCOUPLES

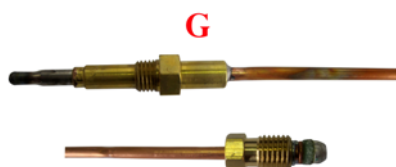

GIUNTO SPECIALE
SPECIAL JOINT

S&P CODE	LUNGHEZZA L LENGHT L	FILETTO GIUNTO Ø THREAD Ø	TYPE
4101003	1000mm	Ø= 9X1	G

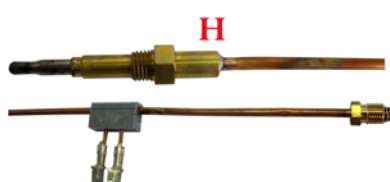

GIUNTO SPECIALE INTERROTTO
SPECIAL JOINT INTERRUPTED

S&P CODE	LUNGHEZZA L LENGHT L	FILETTO GIUNTO Ø THREAD Ø	TYPE
4101034	1000mm	Ø= 9X1	H

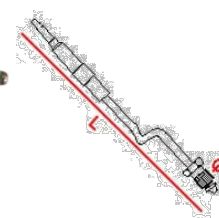

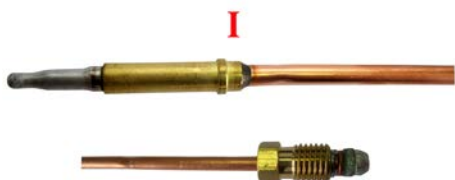

GIUNTO AD ANELLO
RING JOINT

S&P CODE	LUNGHEZZA L LENGHT L	FILETTO GIUNTO Ø THREAD Ø	TYPE
4101093	600mm	Ø= 8X1	I
4101026	750mm	Ø= 8X1	I



GIUNTO SPECIALE FABAs
SPECIAL JOINT FABAs

S&P CODE	LUNGHEZZA L LENGHT L	FILETTO GIUNTO Ø THREAD Ø	TYPE
4101064	750mm	Ø= 9X1	I
4101045	600mm	Ø= 8X1	L

TERMOCOPPIE SPECIALI / SPECIAL THERMOCOUPLES



GIUNTO SPECIALE
SPECIAL JOINT

S&P CODE	LUNGHEZZA L LENGHT L	FILETTO GIUNTO Ø THREAD Ø	TYPE
4101109	600mm	Ø= 9X1	M



GIUNTO SPECIALE
SPECIAL JOINT

S&P CODE	LUNGHEZZA L LENGHT L	FILETTO GIUNTO Ø THREAD Ø	TYPE
4101047	600mm	Ø= 9X1	N

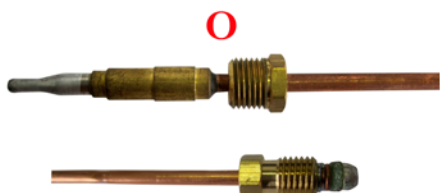

GIUNTO SPECIALE TARGET
SPECIAL JOINT TARGET

S&P CODE	LUNGHEZZA L LENGHT L	FILETTO GIUNTO Ø THREAD Ø	TYPE
4101051	1500mm	Ø= 9X1	O



GIUNTO SPECIALE INTERRUPTO
SPECIAL JOINT INTERRUPTED

S&P CODE	LUNGHEZZA L LENGHT L	FILETTO GIUNTO Ø THREAD Ø	TYPE
4101053	1000mm	Ø= 9X1	P

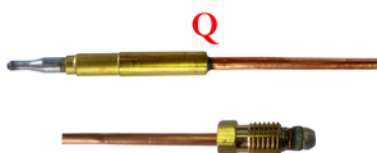

GIUNTO LISCIO SPECIALE
SPECIAL UNIFIED SLEEVE

S&P CODE	LUNGHEZZA L LENGHT L	FILETTO GIUNTO Ø THREAD Ø	TYPE
4101072	750mm	Ø= 8X1	Q



TERMOCOPPIA FLESSIBILE
FLEXIBLE THERMOCOUPLE

S&P CODE	LUNGHEZZA L LENGHT L	FILETTO GIUNTO Ø THREAD Ø	TYPE
4101066	900mm	Ø= 9X1	R

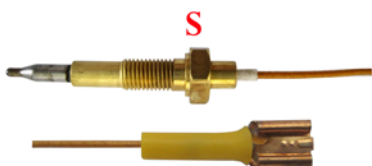

TERMOCOPPIA CON GIUNZIONE CAVI
THERMOCOUPLE WITH FASTON
CONNECTION

S&P CODE	DIMENSIONI Ø DIMENSIONS Ø	LUNGHEZZA CAVO L LENGHT CABLE L	TYPE
4101107	Ø= 6X34mm	750mm	S



TERMOCOPPIA SPECIALE - TIPO J
SPECIAL THERMOCOUPLE - TYPE J

S&P CODE	DIMENSIONI Ø DIMENSIONS Ø	LUNGHEZZA CAVO L LENGHT CABLE L	TYPE
4101041	Ø= 10X72mm	600mm	T

ACCESSORI / ACCESSORIES



**RACCORDO
FRESATO /
SLOTTED FITTING**

S&P CODE	FILETTO GIUNTO Ø THREAD Ø
4101057	M8X1
4101059	M9X1
4101058	M10X1
4101078	11/32 ASA



**RACCORDO
INTERROTTO /
INTERRUPTED JOINT**

S&P CODE	FILETTO GIUNTO Ø THREAD Ø
4101036	M8X1
4101037	M9X1



PROLUNGA TERMOCOPPIA
THERMOCOUPLE EXTENSION

S&P CODE	LUNGHEZZA L LENGHT L	FILETTO GIUNTO Ø THREAD Ø
4101046	600mm	M9X1
4101084	1000mm	M10X1



**DADO PER TERMOCOPPIA /
NUT FOR THERMOCOUPLE**

S&P CODE	GIUNTO THREAD
1141050	FILETTATO

4102001 CANDELA
TONDA M.4 X PILOTA
160 /
ROUND CANDLE M.4
X PILOT 160

22296900:

BERTO'S SPA

1949900:

SILKO ALI SPA

MA1949900:

MARENO

INDUSTRIE ALI SPA

537003000:

LOTUS SPA

RTC900010:

EUROTEC SRL - DIV.

COOKING SERVICE

MBM

61010087:

GIORIK SPA



4111118 GRUPPO
BRUC.GAS 2GR /
GAS BURNER 2GR

30300075:

RANCILIO SPA



1128006 CAVO CON
SPINA STAMP.
SCHUKO 3X1 MT2 /
CABLE WITH PLUG
SCHUKO 3X1 MT2



1128007 CAVO CON
SPINA SCHUKO 3X1,5 -
2000mm /
CABLE WITH PLUG
SCHUKO 3X1,5 -
2000mm



1128041 CABLAGGIO
CONTATORI /
PULSANTIERE
COMPACT EK / WIRING
HARNESS - COUNTERS
/
PUSH BUTTON
COMPACT EK

08564:

LA SPAZIALE SPA



1128023 CAVO
ELETTRICO SILICONE
D. 2,5mm /
SILICONE CABLE D.
2,5mm



1132005 PIEZO
ELETTRICO D. 18mm /
PIEZO ELECTRIC
LIGHTER D. 18

PR36047:

FABA SRL

M02100:

GIGA GRANDI

CUCINE SRL

22188300:

BERTO'S SPA

1936100:

SILKO ALI SPA

BN6A041105:

OLIS DIVISIONE DI

ALI GROUP SPA -

537002800:

LOTUS SPA

MA1936100:

MARENO INDUSTRIE

ALI SPA



1132002 PIEZO
ELETTRICO D. 22MM
AT.TONDO /
PIEZO ELECTRIC
LIGHTER D. 22MM

15010:

CMA MACCHINE PER

CAFFE' SRL

33100003:

ELFRAMO SPA

004944*:

ELECTROLUX

PROFESSIONAL

S.P.A.

210011:

MAGISTER SISTEMA

CAFFE' SRL

690000020:

RANCILIO SPA

537008500:

LOTUS SPA

1031500600:

MARENO INDUSTRIE

ALI SPA

RTC900020:

EUROTEC SRL - DIV.

COOKING SERVICE

MBM

6010047: GIORIK SPA



4130053 RUBINETTO
GAS /
GAS COCK
69000251:
RANCILIO SPA



4116170 FASCETTA
INOX M40 D.40-60 /
STAINLESS STEEL
CLAMP M40 D.40-60
H450135:
HOONVED - ALI SPA
05100003:
ELFRAMO SPA
0620040604:
MODULAR SPA
450135:
COMENDA ALI SPA



4116441 FASCETTA
IN INOX M7 D.7-11 /
TIGHTING PIPE CLAMP
7-11



4116194 GRIGLIA
SCALDATAZZE P4/P6
NERA 310X310MM /
BLACK CUP-WARMER
GRID P4/P6

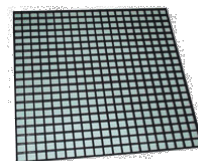

4116440 FASCETTA
IN INOX M10 D.10-17 /
TIGHTING PIPE CLAMP
10-17
450102:
COMENDA ALI SPA



4116357 GRIGLIE
POGGIATAZZE
PLAST.NUOVO TIPOX
BACINELLA /
CUP-WARMER GRID
NEW MODEL
38123666:
RANCILIO SPA

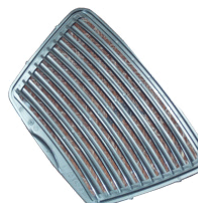

4116003 FASCETTA
STRINGITUBO 12-20 /
TIGHTING PIPE
CLAMP 12-20
923026:
BRICE ITALIA SRL
46003701*:
SCOTSMAN DIV.
FRIMONT SPA
69000081:
RANCILIO SPA
450103:
COMENDA ALI SPA
12010036:
FAGOR
INDUSTRIALE S.R.L.



4116538 RETINA
PIANO LAVORO 3 GR. /
MESH WORK PLAN 3
GR.
03001767:
NUOVA SIMONELLI
SPA



4116568 GRIGLIA
POSATAZZE .2GR. /
GRID-BASED CUPS
.2GR



4116055 FASCETTA
25-40 /
TIGHTING PIPE CLAMP
25-45



4116059 SPAZZOLIN
O DOCCIA /
SHOWER BRUSH



4116054 FASCETTA
D. 20/32 /
TIGHTING PIPE CLAMP
30-32



4116293 SPAZZOLIN
O ACCIAIO /
STAINLESS STEEL
BRUSH



4116266 SCOVOLINO
/ SMALL BRUSH



4116191 SUPPORTO
GOMMA EP5 / RUBBER SUPPORT EP5



4116485 PANNELLO
COMANDI IN PLASTICA S3
SELETRON / PLASTIC PANEL S3
SELETRON
06302:
LA SPAZIALE SPA



4116503 PANNELLO
COMANDI IN PLASTICA S3 EK /
PLASTIC PANEL S3 EK
06300:
LA SPAZIALE SPA



4116504 PANNELLO
PLASTICA 2 MANOPOLE S3 /
PLASTIC PANEL S3
06043
: LA SPAZIALE SPA

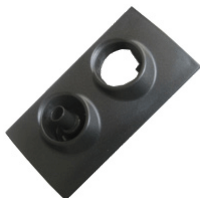

4116601 CORNICE
PER LEVISMO RUBINETTO SPAZIALE
/ FRAME FOR LEVER
MECHANISM TAP-LA SPAZIALE
8489:
LA SPAZIALE SPA



4116617 FIANCHETT
O STILO DX / SIDE STILO DX
030181:
MAGISTER SISTEMA
CAFFE' SRL



4116570 PANNELLO
COMANDI EPOCA
1GR.GRIGIO+FISSAGGI
/ EPOCA PANEL GREY
1GR
10700227:
RANCILIO SPA



4116173 PANNELLO
COMANDI GRIGIO
EPOCA 2 GR / CONTROL PANEL
EPOCA 2 GR.
38123759EX:
RANCILIO SPA



4116474 FIANCO SX
GRIGIO METALLIZZATO
EPOCA / SIDE SX METALLIC
GREY EPOCA
EPOCA:
RANCILIO SPA

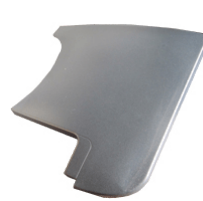

DX=4116483

4116483 FIANCO DX
GRIGIO METALLIZZ.EPOCA-
PL- / SIDE DX METALLIC
GREY EPOCA



SX=4116474

4116544 FIANCHETT
O INFERIORE SX / LOWER LEFT SIDE
COVER
C10: RANCILIO SPA



4116234 TARGHETT
A C10 / PLATE C10
42200122:
RANCILIO SPA



4116616 TARGHETT
A CLASSE 6 / PLATE C6
42200128:
RANCILIO SPA



4116235 TARGHETT
A C10 / PLATE C10
42200124:
RANCILIO SPA



4116219 VASCHETT
A SCARICO ASTORIA /
DRAIN TANK ASTORIA
15502:

CMA MACCHINE PER
CAFFE' SRL



4116206 VASCHETT
A SCARICO SPAZIALE
TIPO SUPER 3000 /
DRAIN TANK
SPAZIALE SUPER TYPE
3000

1590:

LA SPAZIALE SPA



= 2109024

4116218 VASCHETT
A SCARICO 70/100 2 GR
/
DRAIN BASIN 70/100 2
GR

900058:

MAGISTER SISTEMA
CAFFE' SRL



4116242 VASCHETT
A SCARICO NSF /
DRAIN TANK NSF

38123513:

RANCILIO SPA



4116006 VASCHETT
A SCARICO
MACCHINA CAFFE' /
COFFEE MACHINE
DRAIN BASIN

38121007:

RANCILIO SPA



4116532 VASCHETT
A RACCOGLI CAFFE' /
TRAY COLLECTOR
COFFEE



4116533 COPERCHIO
VASCHETTA /
TRAY COVER



4116523 VASCHETT
A SCARICO CECILIA 2
GRUPPI /
DRAIN TANK CECILIA
2 GROUPS

P173:

LA PICCOLA S.A.S.



4116603 BACINELLA
IN BAYBLEND 2 GR. /
BASIN DISCHARGE
BAYBLEND 2 GR

01527:

LA SPAZIALE SPA

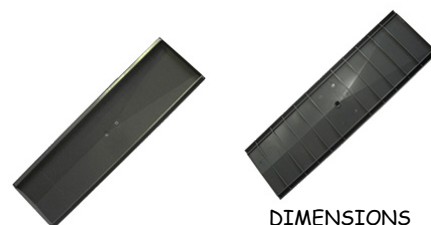

DIMENSIONS
612X150mm

4116434 LATERALE
BACIN. DX /
LATERAL PANEL DX

030147:

MAGISTER SISTEMA
CAFFE' SRL



4116300 KIT
EROGATORE CAFFE' /
COFFEE DITRIBUTOR
KIT



4116301 CORPO
EROGATORE CAFFE' /
COFFEE DISTRIBUTOR
BODY



4116585 COPRIGRUP
PO C7/2012 /
COVER GROUP C7 /
2012



4116431 COPERTUR
A GRUPPO /
COVER FOR GROUP

030090:

MAGISTER SISTEMA
CAFFE' SRL



4116549 COPRIGRUP
PO CROMATO CLASSE
10 /
CHROME COVER
GROUP CLASS 10
21300760:
RANCILIO SPA

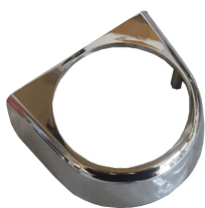

4116470 COPRIGRUP
PO CROMATO /
COVER GROUP
21300780:
RANCILIO SPA



4116004 ROMPIGETT
O SCARICO GR.NE/T /
DRAIN JETBREAKER
GR.NE/T
10090002:
RANCILIO SPA



4116460 GUIDAMMO
TEFLON SNODO
VAPORE /
BUSH FOR STEAM PIPE
36930016:
RANCILIO SPA



4116007 GUIDAMOL
LA SNODO VAPORE
RANCILIO /
STEAM
ARTICULATION
SPRINGDRIVER
RANCILIO
23119005:
RANCILIO SPA



4116005 ROMPIGETT
O GRUPPO INOX /
STAINLESS STEEL
JETBREAKER GROUP
25139001:
RANCILIO SPA



1118013 SPRUZZATO
RE E61 /
SPRAY E61



4116014 COPRILIVEL
LO RE/N /
LEVEL-COVER RE/N
38125007:
RANCILIO SPA



4116606 BIELLETTA
PER RUBINETTO -
SPAZIALE- /
CONNECTING ROD
FOR TAP -SPAZIALE-
08467:
LA SPAZIALE SPA



4116607 CHIAVETTA
x BULLONE
DOCCETTA SPAZIALE /
KEY FOR BOLT
SHOWERS SPAZIALE
00635:
LA SPAZIALE SPA



4116032 CAMMAGR
UPPO LE RANCILIO /
CAMMA
20112501:
RANCILIO SPA



4116070 GIGLEUR
GR.NE RANCILIO /
GIGLEUR GR.NE
RANCILIO
23212018:
RANCILIO SPA



4116076 PIPA
SCARICO
CIMBALI/RANCILIO
CON PASSAGGIO
MAGGIORATO /
DRAIN PIPE
CIMBALI/RANCILIO
69000701:
RANCILIO SPA



210003:
MAGISTER SISTEMA
CAFFE' SRL

4116208 CURVA
OTTONE 3/4 CON
DADO /
BRASS CURVE 3/4
WITH NUT



4116209 DIFFUSORE
DIVINA /
DIFFUSER DIVINA
25739500:
CMA MACCHINE PER
CAFFE' SRL



4116210 DIST.PORTA
DOCCETTA DIVINA /
NET SHOWER SPACER
DIVINA
25422001:
CMA MACCHINE PER
CAFFE' SRL



4116077 PORTADOC
CETTA GRUPPO
EROGAZIONE /
NET SHOWER GROUP
HOLDER
ex43106:
CMA MACCHINE PER
CAFFE' SRL



4116099 ANELLO
AGGANCIATORE
CROMATO /
FILTER HOLDER RING
25250:
CMA MACCHINE PER
CAFFE' SRL



4116311 DIFFUSORE
/
DIFFUSER
25422004:
CMA MACCHINE PER
CAFFE' SRL
WY25422004:
WEGA SRL



4116207 MASSELLO
PER GRUPPO
NICHELATO /
NICHEL THICKNESS
FOR GROUP
31109171:
LA PAVONI SPA



4116279 MUSETTO /
FLANGE
100001:
MAGISTER SISTEMA
CAFFE' SRL



4116281 ROMPIGETT
O GR.EROGAZIONE /
STOP JET
07300124:
NUOVA SIMONELLI
SPA



4116282 PADIGLION
E GRUPPO PR./MAC /
GROUP FLANGE
PR./MAC
98004000:
NUOVA SIMONELLI
SPA

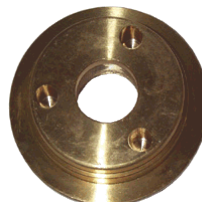

4116593 PISTONCIN
O CHIUSURA
COMPLETO /
COMPLETE GASKET
HOLDER FOR TAP
98008004:
NUOVA SIMONELLI
SPA



4116594 TAPPO
PORTA MOLLA R.V.
PR. 3/8" /
COUPLING 3/8" ø
SPRING HOLDER
07300110:
NUOVA SIMONELLI
SPA



4116081 ROTELLA
REGOLAZIONE
MACINATURA MD /
GRINDING
ADJUSTMENT WHEEL
38120065:
RANCILIO SPA



4116084 SCAMBIATO
RE ESTR. CURVO D. 42
/
HEAT EXCHANGER D.
42
63100:
CMA MACCHINE PER
CAFFE' SRL



4116590 INFUSORE /
INFUSER
900091:
MAGISTER SISTEMA
CAFFE' SRL



4116490 CAMME IN
OTTONE /
BRASS CAMME



4116529 CAMMA
SOLLEVAMENTO /
LIFTING CAMME



4116475 COPRI
FLANGIA IN
ALLUMINIO 12 FORI - 2
PEZZI - E/61 /
STEEL FLANGE COVER
12 HOLES 2 PIECES E61



4116476 COPRI
FLANGIA IN
ALLUMINIO 12 FORI
E/61 /
STEEL FLANGE COVER
12 HOLES E 61



4116095 CANDELA
PORTAGUARNIZIONE /
CANDLE gasket holder



4116541 ASTA
RUBINETTO /
ROD COCK
08461:
LA SPAZIALE SPA



4116473 PORTAPAST
IGLIA RUBINETTO /
TAP pad holder
100112:
MAGISTER SISTEMA
CAFFE' SRL



4116272 ASTA A
CAMMA /
CAM ROD



4116551 GIGLEUR
CON MOLLA /
GIGLEUR WITH
SPRING
80230070:
RANCLIO SPA



4116492 FUNGHETT
O SILICONE 70 Sh /
RUBBER CAP 70 SH



4116267 FERMAPAST
IGLIA RUB. /
PAD BLOCK
100012:
MAGISTER SISTEMA
CAFFE' SRL



4116271 GIGLEUR
GRUPPO D.1,00MM /
GIGLEUR D.1,00MM



4116528 BRACCIO
AMMORTIZZ.GR RE
/BRACKET SHOCK
ADSORBER
20122641EX:
RANCLIO SPA



4116198 GIUNTO
RAPIDO " L " 2X4-1/8"
VIT /
"RAPID JOINT "" L ""
2X4-1/8"" VIT"



4116199 GIUNTO
RAPIDO " T " 2X4-1/8"
VIT /
"RAPID JOINT "" T ""
2X4-1/8"" VIT"



4116201 GIUNTO
RAPIDO " I " 2X4-1/8"
VIT /
"RAPID JOINT "" I ""
2X4-1/8"" VIT"



4116217 PIPA
LIVELLO MGST /
LEVEL PIPE MGST
010041:
MAGISTER SISTEMA
CAFFE' SRL



4116228 COPRILIVEL
LO MGST /
LEVEL COVER MGST
030145:
MAGISTER SISTEMA
CAFFE' SRL



4116233 CHIUSURA
MAGNETICA C10 /
MAGNETIC LOCK C10
69000980
: RANCILIO SPA



4116241 MASCHERIN
A PER LIVELLO /
MASK FOR LEVEL
GLASS



4116260 FASCETTA
100X2,5MM
NEUTRA/NATURAL /
BAND 100X2,5MM
NEUTRA/NATURAL



4116261 FASCETTA
140X2,5MM
NEUTRA/NATURAL /
BAND 140X2,5MM
NEUTRA/NATURAL



4116294 INIETTORE
FAEMA E91 /
INJECTOR FAEMA E91



4116391 PESCANTE
CALDAIA /
BOILER DRAUGHT
900036:
MAGISTER SISTEMA
CAFFE' SRL



4116392 INIETTORE
SCAMB. /
INJECTOR
900035:
MAGISTER SISTEMA
CAFFE' SRL



4116429 CORPO
GRUPPO CON
INFUSORE /
BODY GROUP WITH
INFUSER
20101901:
RANCILIO SPA



4116506 CORPO
GRUPPO 85 /
BODY GROUP



4116572 LATTIERA
IN ACCIAIO
RIVESTIMENTO
ANTIADERENTE 350
ML /
NON-STICK COATING
STEEL MILK 350 ML



4116573 LATTIERA
IN ACCIAIO
RIVESTIMENTO
ANTIADERENTE 500
ML /
NON-STICK COATING
STEEL MILK 500 ML



4116027 PRESSINO A
MANO PLASTICA /
PLASTIC MANUAL
DAMPNER
38120005:
RANCILIO SPA



4116477 RACCORDO
INTERMEDIO PER
FORM. TUBO VAP. /
MIDDEL JOINT FOR
STEAM PIPE



4116489 LEVA
COMANDO GR..E/61
C/ROTELLA /
LEVER FOR GROUP
E/61



4116493 LEVA
INFERIORE CROMATA
TERRY /
LOWER LEVER TERRY



4116530 LEVA
COMANDO LUNGA
CROMATA /
LONG LEVER



4116507 LEVA
ACCIAIO LUNGA /
STEEL LONG LEVER
P127:
LA PICCOLA S.A.S.



4116595 ASTA INOX
RUBINETTO VAPORE /
TAP STAINLESS STEEL
PIN
07300221:
NUOVA SIMONELLI
SPA



4116623 Perno
Rubinetto Vapore P4-6 /
PIN STEAM VALVE P4-
6



4116508 SCAMBIATO
RE CAFFÈ 50X30X 110 /
HEAT EXCHANGER
50X30X110
M1A:
LA PICCOLA S.A.S.



4116509 ACCELERAT
ORE 92 /
ACCELERATOR 92
M5A:
LA PICCOLA S.A.S.



4116511 PIASTRA
INFERIORE 40X15 /
LOWER BRACKET
40X15
M3A:
LA PICCOLA S.A.S.



4116522 SPINA 8X50 /
PLUG 8X50
M21B:
LA PICCOLA S.A.S.



4116524 TANICA 9
LT /
TANK 9LT
P73:
LA PICCOLA S.A.S.



4116527 FORNELLO
GAS 3 GR. /
GAS BURNER 3 GR
210020:
MAGISTER SISTEMA
CAFFÈ SRL



4116169 GHIERA
MOZZO INFERIORE P-
C-B-A-GR-6-7-8-9
SILANOS /
PLASTIC RING P-C-B-
A-GR-6-7-8-9 SILANOS
900035:
SILANOS SRL



4116000 PIANTONE
COMPLETO ARC /
OPPOSITE SUPPORT
ARC
5902:
A.T.A. SRL



3105009 PIEDINO
LAVATAZZE M8 /
CUP-WASHERS
SUPPORT M8
904980:
SILANOS SRL

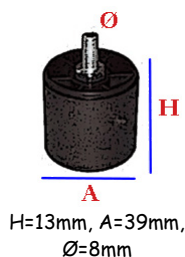

3105054 PIEDINO
LAVASTOVIGLIE M10
hmrsn /
FOOT DISHWASHER
M10 hmrsn
984006000:
GRUPPO CIMBALI SPA
9030005:
GRUPPO CIMBALI SPA

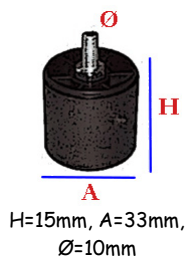

3105001 PIEDINO LT
M10 /
SUPPORT LT M10
69000230:
RANCILIO SPA

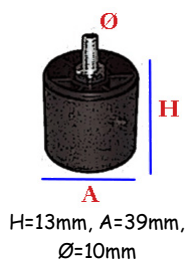

3105030 PIEDINO
30MM M10 /
FOOT 30 MM
210203:
COMENDA ALI SPA

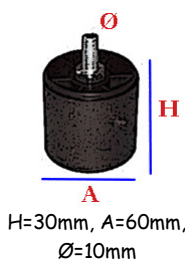

3105022 PIEDINO
BASE ESAGONALE
HNVD M10 /
SUPPORT HOONVED
210210:
HOONVED - ALI SPA
25209ex:
HOONVED - ALI SPA

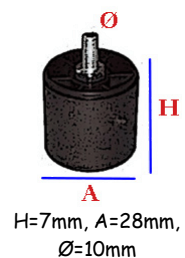

3105037 PIEDINO
REGOLABILE D=47 /
ADJUSTABLE
SUPPORT D=54
00000970:
ELFRAMO SPA

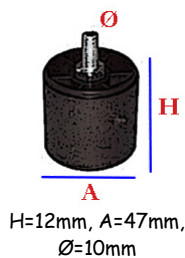

3105015 PIEDINO
M10 LAVAPIATTI /
FOOT M10
904990:
SILANOS SRL

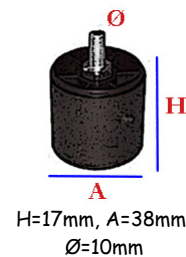

3105024 PIEDINO
REGOLABILE FAB A /
SUPPORT FAB A
ALL MODEL/TUTTI I
MODELLI: FAB A SRL



3105066 PIEDINI IN
GOMMA /
RUBBER SUPPORT
EB019: OBEL SRL



3105026 PIEDINO
COMPLETO MAZZER /
COMPLETE SUPPORT
MAZZER
500SPIA01QQQ:
MAZZER LUIGI SPA

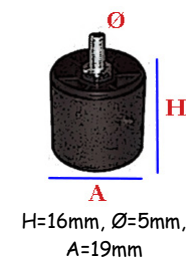

3105045 PIEDINO M6
D.20 H.15mm /
LEG DD 2015 H
P000PIA02QQQEX:
MAZZER LUIGI SPA
P000PIA04QQQ:
MAZZER LUIGI SPA

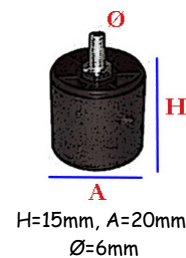
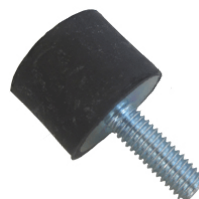

3105008 PIEDINO Z11
COMPLETO M10 /
COMPLETE SUPPORT
Z11
10090012:
RANCILIO SPA

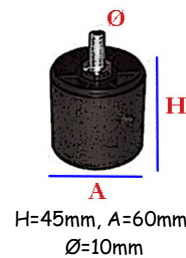
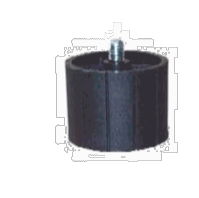

3105017 PIEDINO
REGOLABILE/RIALZAB
ILE UNIVERSALE /
UNIVERSAL
ADJUSTABLE/RAISABL
E SUPPORT
0300030+0300040:
**MAGISTER SISTEMA
CAFFE' SRL**
900069:
**MAGISTER SISTEMA
CAFFE' SRL**



H=57mm, A=58mm,
Ø=10mm

3105032 PIEDINO
AFFETTATRICE
FAMIGLIA A VENTOSA
M5 /
SUPPORT FOR SLICER
M5



3105050 PIEDINO
VENTOSA ALTO M6
H.45mm /
FOOT P.6 H. 42 mm



H=45mm, A=45mm,
Ø=6mm

3105042 PIEDINO
PER AFFETTATRICE
M8 H35mm /
SLICER SUPPORT H
33mm D.8mm



H=35mm, A=47mm,
Ø=8mm

3105035 PIEDINO A
VENTO D.40 H.10 /
FOOT D.40 H.10



3105023 PIEDINO
BASE ESAGONALE
INOX 55/65
REGOLABILE M10 /
STAINLESS STEEL
SUPPORT 55/65 M10



H min=55mm,
H max=65mm, A=33mm,
Ø=10mm

3105003 PIEDINO
COMPLETO Z9/S10 /
COMPLETE SUPPORT
Z9/S10
10090011:
RANCILIO SPA



H=41mm, Ø=10mm

3105048 PIEDINO
REGOLABILE RESINA /
ADJUSTABLE FOOT
RESIN
K01086:
**ARISTARCO KASTEL
SPA**
10017:
**BREMA ICE MAKERS
SPA**



H=17mm, HTot=39mm,
A=27mm, Ø=17mm

3105060 PIEDINO
REGOLABILE IN
PLASTICA NERO ALTO
/
ADJUSTABLE FOOT
PLASTIC BLACK HIGH
DW10851:
DIHR-ALI SPA



H=20mm, HTot=50mm,
A=27mm, Ø=17mm

3105038 PIEDINO
ESAGONALE PER
LAVABICCHIERI /
GLASS-WASHERS
SUPPORT
461010:
**ELETTOBAR
DIVISIONE DELLA
EUROTEC SRL**



3105028 PIEDINO
GOMMA NERA NE AC /
BLACK RUBBER FOOT
S90 NE SE
210404:
COMENDA ALI SPA
H210404:
HOONVED - ALI SPA

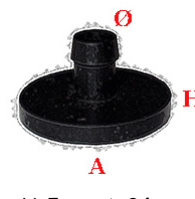

H=5mm, A=34mm,
Ø=10mm

3105020 GOMMINO
PER PIEDINO
MAGISTER /
RUBBER FOOT FOR
Magister
030040:
**MAGISTER SISTEMA
CAFFE' SRL**

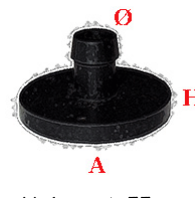

H=6mm, A=55mm,
Ø=20mm

3105053 PIEDINO
DURO /
FOOT HARD
C00071614:
MACAP SRL



3105055 PIEDINO /
FOOT
PR60009: FABA SRL

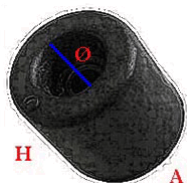

H=18mm, A=18mm,
Ø=8mm

3105018 RIALZO
PIEDINO H48mm /
SUPPORT H46mm



A=77mm, H=48mm

3118014 RACCORDO
A PIPA /
PIPE JOINT
38121034:
RANCILIO SPA
030151:
MAGISTER SISTEMA
CAFFE' SRL

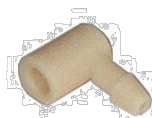

1125149 GHIERA DI
RIDUZIONE 1/4"X3/8"
SENZA BATTUTA /
RING NUT 1/4"x3/8"



1125221 "RIDUZIONE
3/8"-1/4" INOX da
TORN."
/ INOX REDUCTION
3/8"-1/4"
35273:
HOONVED - ALI SPA



1125176 RACCORDO
PORTAGOMMA /
FITTING HOLDER
RUBBER



1125115 RACC.
PORTAGOMMA M D.8
3/8x ADDOLCITORE
AUTOMATICO /
RUBBER-HOLDER M
D.8 3/8



1125116 RACC.
PORTAGOMMA M D.13
3/8 /
RUBBER-HOLDER M
D.13 3/8



1125071 PORTAGOM
MA F1/8 X 6 /
RUBBER-HOLDER F1/8
X 6



1125175 RACCORDO
VALVOLA /
FITTING VALVE



1125179 RACCORDO
IN OTTONE 3/8
PORTAGOMMA D12 /
BRASS CONNECTOR
3/8 HOSE
CONNECTION D12
927015:
ELETTROBAR
DIVISIONE DELLA
EUROTEC SRL



1125157 RACCORDO
CORPO POMPA FIR
M16 /
BODY PUMP
CONNECTION FIR M16
9180010:
GRUPPO CIMBALI
SPA



1125167 RACCORDO
POMPA M12 /
BODY PUMP
CONNECTION M12
4758:
UNIVER-BAR SRL

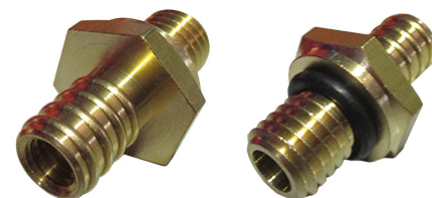

1125219 RACCORDO
POMPA M12 /
FITTING PUMP M12



M12

1125038 RACC.
SERPENTINA VAPORE
/
STEAM COIL
CONNECTION

280512:

COMENDA ALI SPA



1125034 PORTAGOM
MA OTTONE M.14X1 /
BRASS HOSE NOZZLE
M.14X1

34767:

HOONVED - ALI SPA



1125182 "RACCORD
O PORTAGOMMA F
1/2"X14" /
FITTING HOLDER
RUBBER-F 1/2 " X14 "



1125009 BUSSOLA
RUBINETTO /
TAP BUSH

23224001:

RANCILIO SPA

20126002EX:

RANCILIO SPA

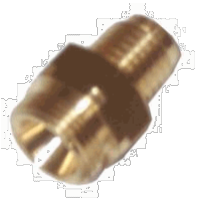

1125022 RACCORDO
PORTASONDA X
CALDAIA /
BOILER PROBE-
HOLDER JUNCTION

23218007:

RANCILIO SPA



1125088 RACCORDO
1200322/1 /
JUNCTION 1200322/1



1125087 RACCORDO
PER ACQUA CALDA
RANC. /
JUNCTION FOR HOT
WATER RANC.



1125138 NIPPLES
1/2" M CROMATO - F
PASSO METRICO /
"NIPLES 1/2" M"



GASKET= 2107162

1125010 DADO
RUBINETTO VAPORE /
STEAM COCK NUT

26220015:

RANCILIO SPA

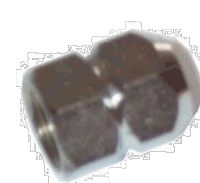

1125171 "GOMITO
MF 3/4" /
ELBOW MF 3/4" "



1125174 RACCORDO
GAS 1/4M /
GAS FITTING 1/4M



1125032 RACCORDO
TIPO BAR /
JOINT TYPE BAR

210074:

MAGISTER SISTEMA
CAFFE' SRL



1125004 BRACCIO
RINVIO NE /
RETURN ARM NE

20122631:

RANCILIO SPA



1125153 RACCORDO
RAPIDO 10-3/8"
X6101077 /
CONNECTION 10-3/8" X
6101077



1125154 RACCORDO
RAPIDO 8-3/8" /
CONNECTION 8-3/8"



1125159 RACCORDO
TENUTA OLIO /
OIL SEAL FITTING



Ø GUARNIZIONE=
22X14X1,5mm

1125158 RACCORDO
A T SL /
T-PIECE

20123001:
RANCILIO SPA



1139001 VETRO
LIVELLO RANCILIO
12X1,5X140 /
LEVEL GLASS
RANCILIO
41010010:
RANCILIO SPA



1139021 TUBO
LIVELLO
EPOCA/CLASSE 10 /
LEVEL GLASS
EPOCA/CLASSE 10
38228066:
RANCILIO SPA



1139021 TUBO
LIVELLO
EPOCA/CLASSE 10 /
LEVEL GLASS
EPOCA/CLASSE 10
38228066:
RANCILIO SPA



1139026 VETRINO
LIVELLO /
LEVEL GLASS
38123856:
RANCILIO SPA



1139022 VETRO PER
LIVELLO FAEMA /
LEVEL GLASS FOR
FAEMA



1139023 VETRO
LIVELLO FAEMA
COMPLETO /
COMPLETE LEVEL
GLASS FAEMA



1139003 VETRO
LIVELLO FAEMA E61 /
LEVEL GLASS FAEMA
E61

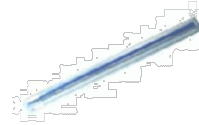

1139004 VETRO
LIVELLO WEGA /
LEVEL GLASS WEGA



gasket=2102050

1139009 VETRO
LIVELLO D.
11X1,5X185H /
LEVEL GLASS D.
11X1,5X185H



1139010 VETRO
LIVELLO D.
11X1,5X145H SPAZIALE
/
LEVEL GLASS D.
11X1,5X145H
267:
LA SPAZIALE SPA

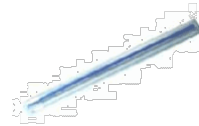

1139011 VETRO
LIVELLO D. 12X1,5X117
CIMBALI /
LEVEL GLASS D.
12X1,5X117 CIMBALI



1139028 VETRO
LIVELLO /
LEVEL GLASS



= 2101380

1120027 COPPIA
MACINE DRM ALINOX
Ø 68 DX /
PAIR GRINDERS DRM
ALINOX D. 68 RIGHT

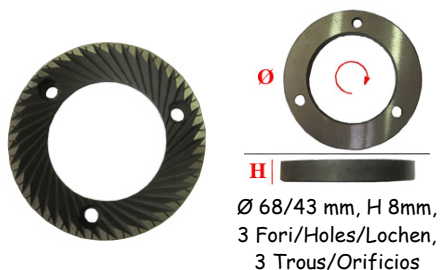

1120092 COPPIA
MACINE HAUS ANFIM
D.50 /
PAIR GRINDERS HAUS
ANFIM D.50
50: ANFIM SAS

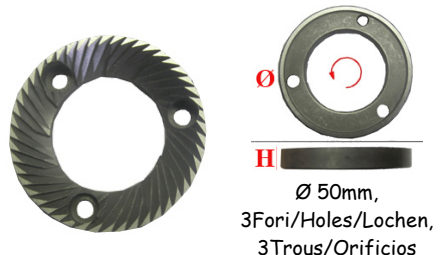

1120008 COPPIA
MACINE ANFIM D.64 /
PAIR GRINDERS
ANFIN D. 64

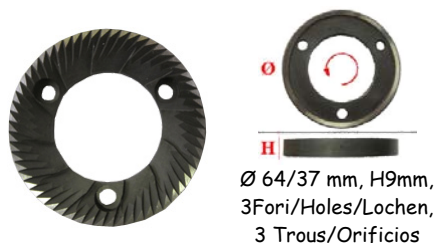

1120030 COPPIA
MACINE ANFIN D.75 SX
/
PAIR GRINDERS ANFIN
D.75 LEFT

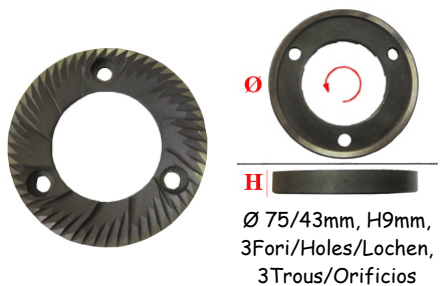

1120047 COPPIA
MACINE MM64
DIS.1224 ARISTARCO /
PAIR GRINDERS MM64
ARISTARCO
70111: ARISTARCO
SPA



1120079 COPPIA
MACINE CASADIO D.
84 /
PAIR GRINDERS
CASADIO D. 84

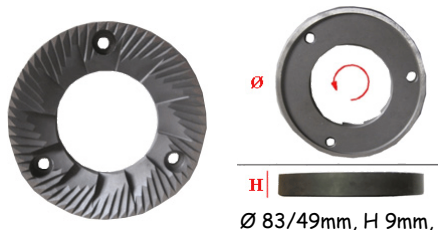

3 Fori/Holes/lochen,
3 TrouS/orificios

1120021 COPPIA
MACINE CIMBALI D.54
/
PAIR GRINDERS
CIMBALI D. 54

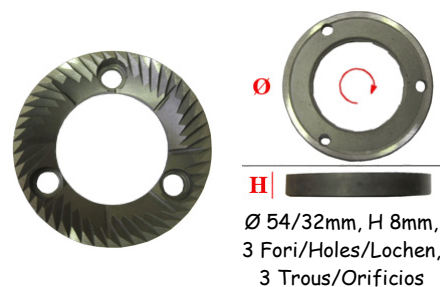

1120004 COPPIA
MACINE CIMBALI D. 64
/
PAIR GRINDERS
CIMBALI D. 64

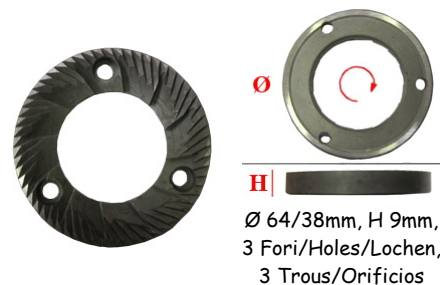

1120068 COPPIA
MACINE CIMBALI-
FAEMA D.75 DX /
PAIR GRINDERS
CIMBALI D. 75 DX

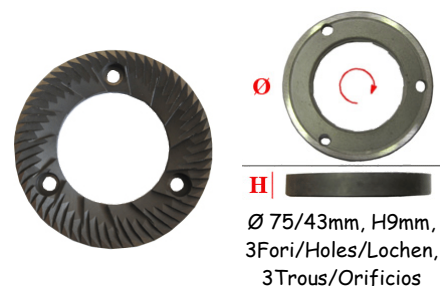

1120057 COPPIA
MACINE D.80 /
PAIR GRINDERS D. 80
SCREWED
75307:
DITTING
MASCHINEN AG

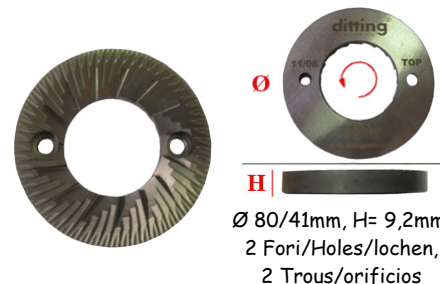

1120058 COPPIA
MACINE D.90 MSN /
PAIR GRINDERS D. 90
MSN
75400:
DITTING
MASCHINEN AG



1120059 COPPIA
MACINE D.100 MSN /
PAIR GRINDERS D.100
MSN

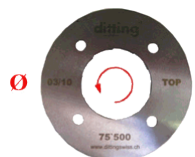

H |
Ø 100/46mm,
H=9,2mm, 4
Fori/Holes/lochen,
4 TrouS/orificios

1120099 COPPIA
MACINE DITTING D.120
KFA/KFR1203 /
COUPLE GRINDING
D.120 DITTING
KFA/KFR1203



H |
Ø 120/64mm,
4Fori/Holes/lochen,
4 TrouS/orificios

1120060 COPPIA
MACINE D.140 P MSN /
PAIR GRINDERS D.140 P
MSN
75702:
DITTING
MASCHINEN AG



H |
Ø 140/70mm,H=9,2mm,
4 Fori/Holes/lochen,
4 TrouS/orificios

1120102 COPPIA
MACINE DITTING D.180
H9 /
PAIR OF BLADES D.180
DITTING H9



H |
Ø180mm, H9mm,
3Fori/Holes/Lochen,
3 TrouS/orificios

1120098 COPPIA
MACINE EUREKA D.64 /
PAIR OF GRINDING
EUREKA d.64

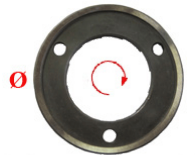

H |
Ø 64/37,6mm,
3Fori/Holes/Lochen,
3 TrouS/orificios

1120100 COPPIA
MACINE PIANE mm65
EUREKA OR /
GRINDING BLADES
FLAT mm65 EUREKA
MCD4:
EUREKA - CONTI
VALERIO SRL

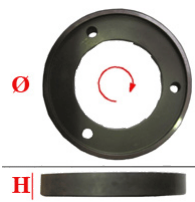

1120101 COPPIA
MACINE PIANE mm75
OR /
GRINDING BLADES
FLAT mm 75 EUREKA
OR
MCD4:
EUREKA - CONTI
VALERIO SRL



Ø 65mm,
3Fori/Holes/Lochen,
3 TrouS/orificios



H |
Ø 75mm, H9mm,
3Fori/Holes/Lochen,
3 TrouS/orificios

1120014 COPPIA
MACINE
QUICK/FAEMA 49DX /
PAIR GRINDERS
QUICK/FAEMA 49
RIGHT



H |
Ø 49/30 mm, H 8mm,
3 Fori/Holes/Lochen,
3 TrouS/orificios

1120020 COPPIA
MACINE FAEMA
D.54DX /
PAIR GRINDERS
FAEMA D. 54 RIGHT



H |
Ø 54/31mm, H8 mm,
3 Fori/Holes/Lochen,
3 TrouS/orificios

1120025 MACINE
FAEMA D. 54 SX /
PAIR GRINDERS
FAEMA D. 54 LEFT

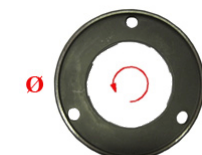

H |
Ø 54/31mm, H 8mm,
3 Fori/Holes/Lochen,
3 TrouS/orificios

1120019 COPPIA
MACINE FAEMA D64
DX /
PAIR GRINDERS
FAEMA D64 RIGHT

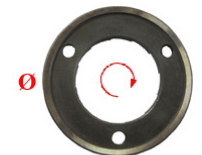

H |
Ø 64/37mm, H 9MM,
3 Fori/Holes/Lochen,
3 TrouS/orificios

1120022 MACINE
 FIORENZATO D. 64 /
 PAIR GRINDERS
 FIORENZATO D. 64
1120022:
 FIORENZATO SRL

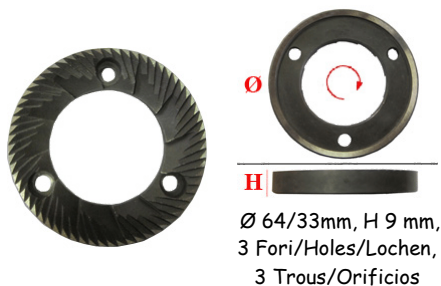

Ø 64/33mm, H 9 mm,
 3 Fori/Holes/Lochen,
 3 TrouS/Orificios

1120107 COPPIA
 MACINE FIORENZATO
 CS D.64 DX /
 PAIR GRINDERS
 FIORENZATO CS D.64
 DX
1120107:
 FIORENZATO SRL



Ø 64/37mm, H=8,5mm,
 3Fori/Holes/Lochen,
 3TrouS/Orificios

1120106 COPPIA
 MACINE FIORENZATO
 MC 82,5 DX /
 PAIR GRINDERS
 FIORENZATO MC 82,5
 DX
1120106:
 FIORENZATO SRL

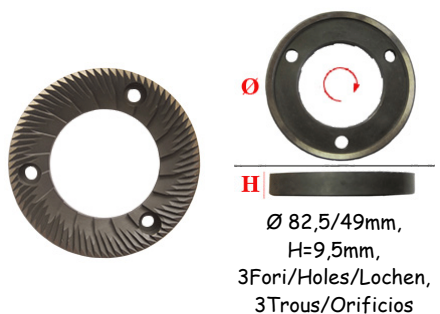

Ø 82,5/49mm,
 H=9,5mm,
 3Fori/Holes/Lochen,
 3TrouS/Orificios

1120024 COPPIA
 MACINE FIORENZATO
 D. 83 /
 PAIR GRINDERS
 FIORENZATO D. 83
1120024:
 FIORENZATO SRL

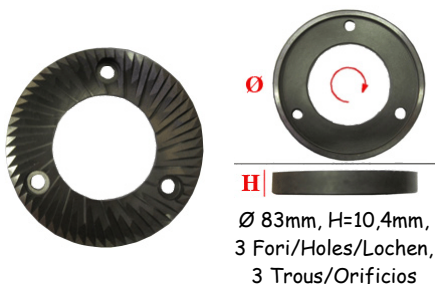

Ø 83mm, H=10,4mm,
 3 Fori/Holes/Lochen,
 3 TrouS/Orificios

1120109 COPPIA
 MACINE 50/1400 M2 /
 PAIR GRINDERS 50/1400
 M2
C244006: MACAP SRL

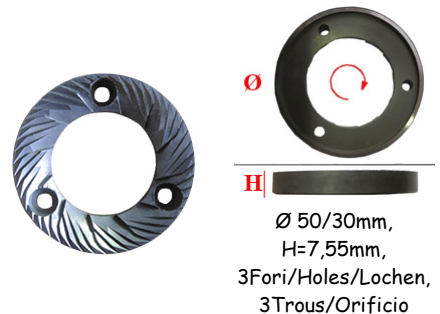

Ø 50/30mm,
 H=7,55mm,
 3Fori/Holes/Lochen,
 3TrouS/Orificio

1120071 COPPIA
 MACINE D. 58/1400 /
 PAIR GRINDERS D.
 58/1400
C0004M135:
 MACAP SRL

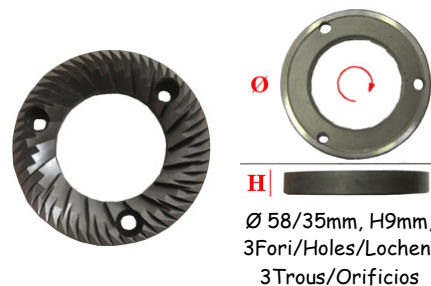

Ø 58/35mm, H9mm,
 3Fori/Holes/Lochen,
 3TrouS/Orificios

1120083 COPPIA
 MACINE D. 58 M5D /
 PAIR GRINDERS D. 58
 M5D
C0004M135A:
 MACAP SRL



Ø 58/35mm, H9mm,
 3Fori/Holes/Lochen,
 3TrouS/Orificios

1120097 COPPIA
 MACINE D. 65/900 /
 COUPLE GRINDING D.
 65/900
C0004M122A:
 MACAP SRL

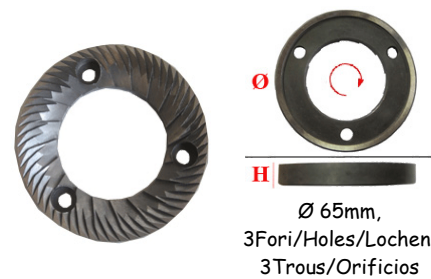

Ø 65mm,
 3Fori/Holes/Lochen,
 3TrouS/Orificios

1120104 COPPIA
 MACINE 70 /
 PAIR OF BLADES 70
C0004M123:
 MACAP SRL

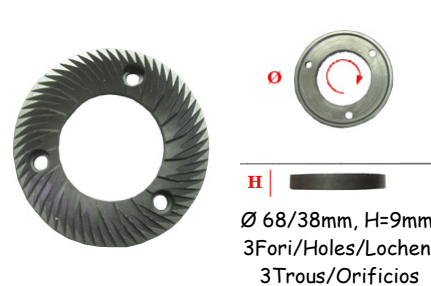

Ø 68/38mm, H=9mm,
 3Fori/Holes/Lochen,
 3 TrouS/Orificios

1120111 COPPIA
 MACINE 74/1400 /
 PAIR GRINDERS 74/1400
C0004M121:
 MACAP SRL

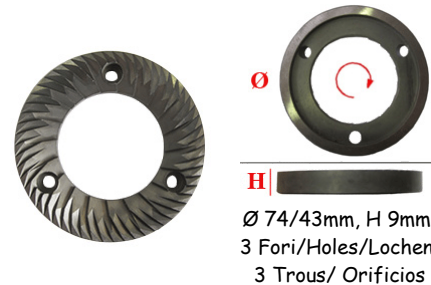

Ø 74/43mm, H 9mm,
 3 Fori/Holes/Lochen,
 3 TrouS/ Orificios

1120073 COPPIA
 MACINE D. 75/900 /
 PAIR GRINDERS D.
 75/900
C0004M121A:
 MACAP SRL

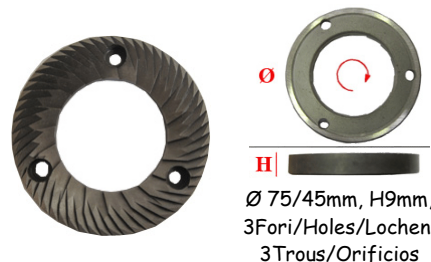

Ø 75/45mm, H9mm,
 3Fori/Holes/Lochen,
 3 TrouS/Orificios

1120044 COPPIA
MACINE MAHLKOENIG
D.65 K30ES /
PAIR GRINDERS X
K30ES D. 65
MAHLKOENIG
K30ES:
MAHLKOENIG GmbH &
Co. Kg

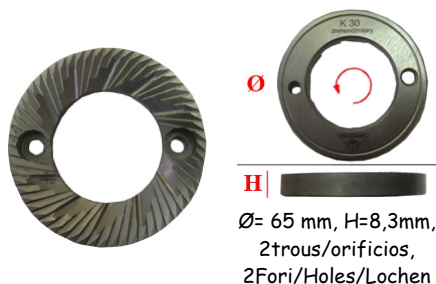

1120053 COPPIA
MACINE MAHLKONIG
GUATEMALA SB /
PAIR GRINDERS
MAHLKONIG
GUATEMALA SB
3921:
MAHLKOENIG GmbH &
Co. Kg

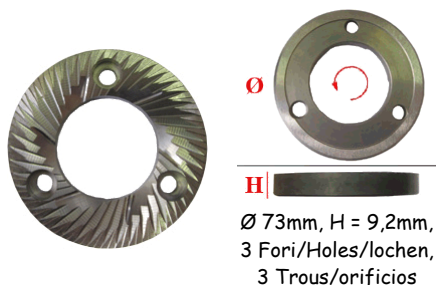

1120054 COPPIA
MACINE MAHLKONIG
EP43 - EK43 /
PAIR GRINDERS
MAHLKONIG EP43
303931:
MAHLKOENIG GmbH &
Co. Kg

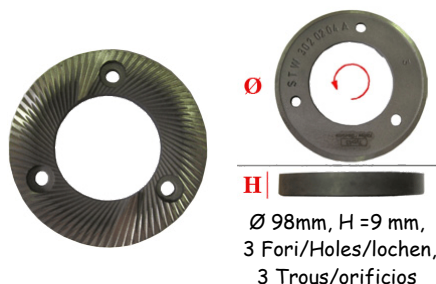

1120042 COPPIA
MACINE MAHLKOENIG
PER K501 D.115 /
PAIR GRINDERS X K501
D. 115
310140:
MAHLKOENIG GmbH &
Co. Kg

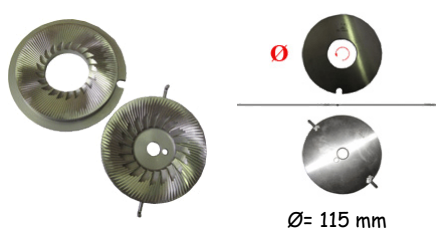

1120039 COPPIA
MACINE INOX H9,4,X
D.120SX MAHLKOENIG
/
PAIR GRINDERS H9,4 X
D.120 LEFT
MAHLKOENIG
VTA6S:
MAHLKOENIG GmbH &
Co. Kg

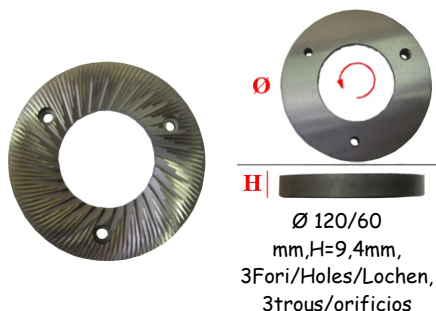

1120040 COPPIA
MACINE GHISA H11,2X
D.120SX MAHLKOENIG
/
PAIR GRINDERS H9,4 X
D.120 LEFT
MAHLKOENIG
VTA6S:
MAHLKOENIG GmbH &
Co. Kg

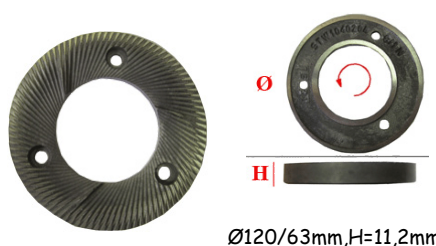

3Fori/Holes/Lochen,
3trous/orificios

1120045 COPPIA
MACINE MAHLKOENIG
PER DK7LS D.180 H.13,5
/
PAIR GRINDERS X
DK7LS D. 180 H.13,5
MAHLKOENIG
303950:
MAHLKOENIG GmbH
& Co. Kg



1120064 COPPIA
MACINE DK15LH TC
D.130 H.12 /
PAIR GRINDERS
308293:
MAHLKOENIG GmbH &
Co. Kg



1120046 COPPIA
MACINE MAHLKOENIG
PER DK5LS-DK15 D.130
H.12 /
PAIR GRINDERS X
DK5LS D.130 H.12
MAHLKOENIG
DK15-DK5:
MAHLKOENIG GmbH
& Co. Kg



1120065 COPPIA
MACINE MAZZER MINI
D.58 /
PAIR GRINDERS
MAZZER MINI D.58
FMA00182DQQQ:
MAZZER LUIGI SRL

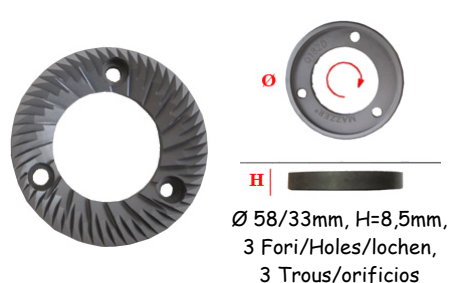

1120077 COPPIA
MACINE MAZZER LUX
/
PAIR GRINDERS
MAZZER LUX
FMA00195DQQQ:
MAZZER LUIGI SRL



1120069 COPPIA
MACINE MAZZER MINI
ELECTRONIC /
PAIR GRINDERS
MAZZER MINI
ELECTRONIC
FMA00189DQQQ:
MAZZER LUIGI SRL



1120006 COPPIA
MACINE MAZZER D.84
MONOFASE /
PAIR GRINDERS
MAZZER D. 84



1120005 COPPIA
MACINE MAZZER D. 64
MONOFASE /
PAIR GRINDERS
MAZZER D. 64



1120052 COPPIA
MACINE MAZZER D.84
OR. MONOFASE /
PAIR GRINDERS
MAZZER D. 84 OR.
MONOPHASE
FMA00151AQQQ:
MAZZER LUIGI SRL



1120031 COPPIA
MACINE MAZZER D.64
OR MONOFASE /
PAIR GRINDERS
MAZZER D.64 OR
FMA00033MQQQ:
MAZZER LUIGI SRL



1120051 COPPIA
MACINE MAZZER D.84
TRIFASE NO /
PAIR GRINDERS
MAZZER D. 84 3PHASES



1120050 COPPIA
MACINE MAZZER D.64
TRIFASE NO /
PAIR GRINDERS
MAZZER D. 64 3PHASES



1120032 COPPIA
MACINE MAZZER D.84
ORTRI /
PAIR GRINDERS
MAZZER D.84 ORTRI
FMA00151BQQQ:
MAZZER LUIGI SRL



1120041 COPPIA
MACINE MAZZER D.64
OR TRIFASE /
PAIR GRINDERS
MAZZER D.64 OR
THREE-PHASE
FMA00033TQQQ:
MAZZER LUIGI SRL



1120076 COPPIA
MACINE MAZZER
DR100 TRIFASE /
PAIR GRINDERS
MAZZER DR100
3PHASES
FMA0T193SQQQ:
MAZZER LUIGI SRL



1120075 COPPIA
MACINE MAZZER ZAR
MONOFASE /
PAIR GRINDERS
MAZZER ZAR 1 PHASE
FMA0T190SQQQ:
MAZZER LUIGI SRL

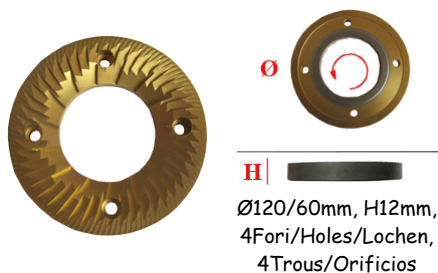

1120074 COPPIA
MACINE MAZZER ZAR
TRIFASE /
PAIR GRINDERS
MAZZER ZAR 3PHASES
FMA0T188SQQQ:
MAZZER LUIGI SRL



1120093 COPPIA
MACINE D50 3 FORI
NUOVA SIMONELLI /
PAIR GRINDERS D.50
3HOLES NUOVA
SIMONELLI
15800045:
NUOVA SIMONELLI
SPA



1120108 COPPIE
MACINE OBEL D.50 /
PIAR GRINDERS OBEL
LEFT D.50
DF8: OBEL SRL

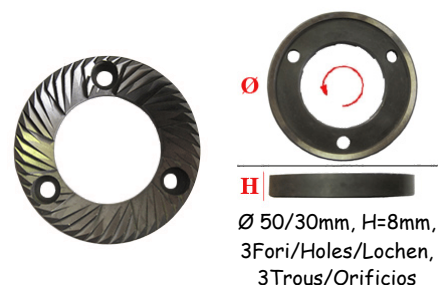

1120009 COPPIA
MACINE
BRASILIA/OBEL 3F
64SX /
PAIR GRINDERS
BRASILIA 3 HOLES 64
LEFT
EB08: OBEL SRL
0005820004:
BRASILIA SPA

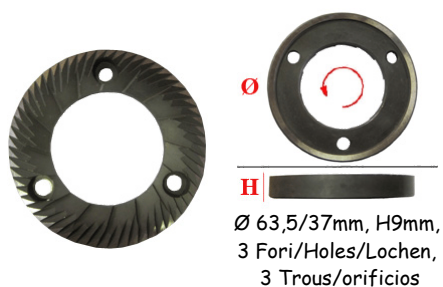

1120062 COPPIA
MACINE MAB60
MOKA-ESPRESSO /
PAIR GRINDERS MAB60
MOKA-ESPRESSO
MAB60MOKA-ESPRES:
PETRONCINI
IMPIANTI S.P.A.

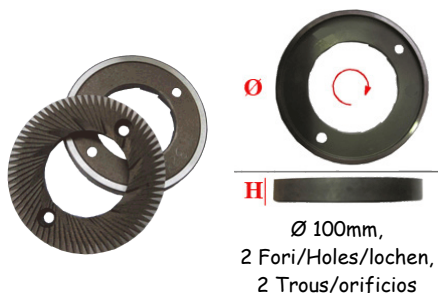

1120013 COPPIA
MACINE QUICK 43DX /
PAIR GRINDERS QUICK
43 LEFT

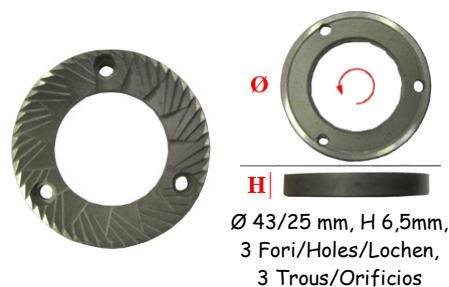

1120015 COPPIA
MACINE RANCILIO
50SX /
PAIR GRINDERS
RANCILIO 50 LEFT
69000032:
RANCILIO SPA

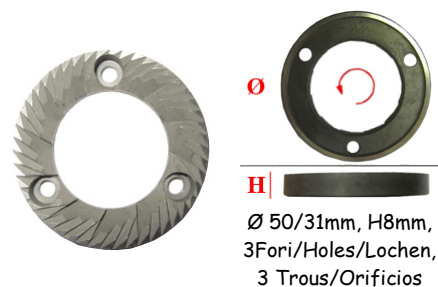

1120001 COPPIA
MACINE D.63,5 /
PAIR GRINDERS D. 63,5
69000033:
RANCILIO SPA



1120002 COPPIA
MACINE D.75 /
PAIR GRINDERS D. 75
MD80: RANCILIO SPA

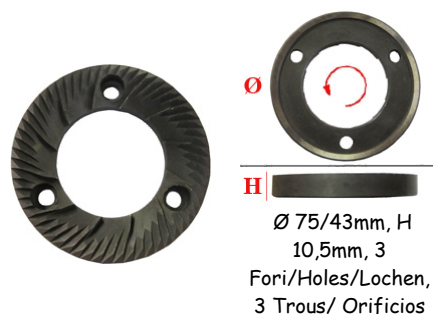

1120017 COPPIA
MACINE PIANA SAECO
43SX /
PAIR GRINDERS SAECO
43 LEFT

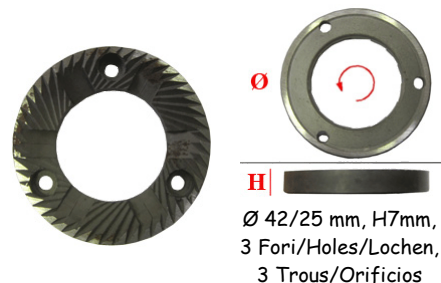

1120066 COPPIA
MACINE D.108X38XH12
/
PAIR GRINDERS
D.108X38XH12

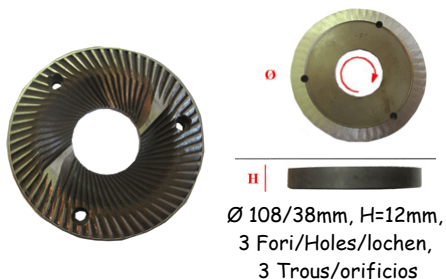

Ø 108/38mm, H=12mm,
3 Fori/Holes/lochen,
3 TrouS/orificios

1120007 COPPIA
MACINE SAN MARCO
D.64 /
PAIR GRINDERS SAN
MARCO D. 64

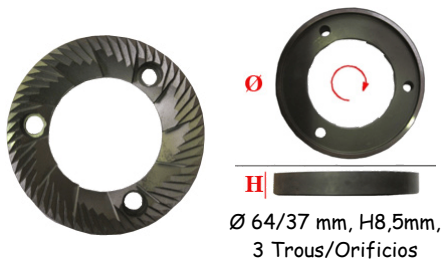

Ø 64/37 mm, H8,5mm,
3 TrouS/Orificios

1120029 COPPIA
MACINE SAN MARCO
D.84DX /
PAIR GRINDERS SAN
MARCO D.84 RIGHT

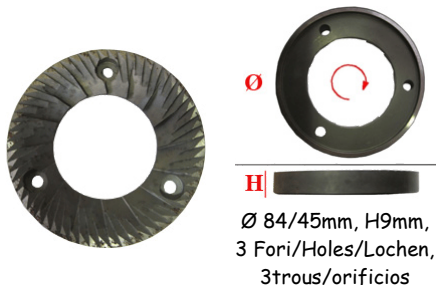

Ø 84/45mm, H9mm,
3 Fori/Holes/Lochen,
3trous/orificios

1120018 COPPIA
MACINE WEGA-
COMP.D64 DX /
PAIR GRINDERS WEGA
D. 64 RIGHT
1120018:
**WEGA MACCHINE PER
CAFFE' SRL**

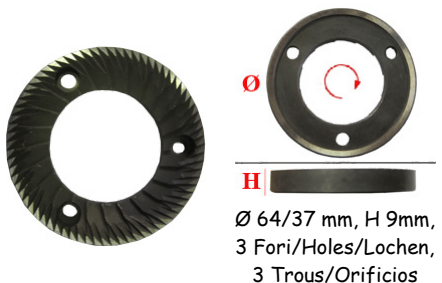

Ø 64/37 mm, H 9mm,
3 Fori/Holes/Lochen,
3 TrouS/Orificios

1120091 COPPIA
MACINE 65D K099
MAC. ASC. WEGA /
PAIR GRINDERS 65D
K099 MAC. ASC. WEGA
WY28217000:
**WEGA MACCHINE PER
CAFFE' SRL**

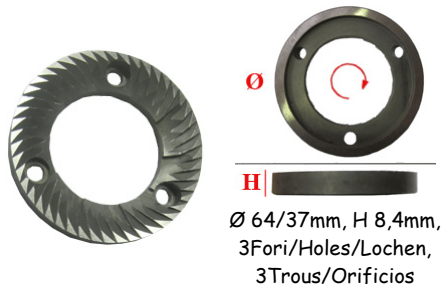

Ø 64/37mm, H 8,4mm,
3Fori/Holes/Lochen,
3TrouS/Orificios

1120080 COPPIA
MACINE WEGA
COMPAK D 80 /
PAIR GRINDERS WEGA
COMPAK D 80

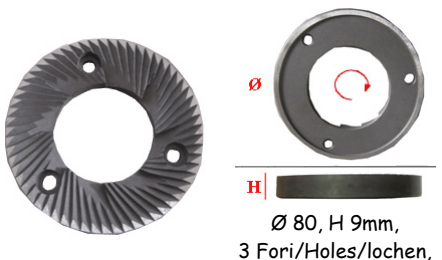

Ø 80, H 9mm,
3 Fori/Holes/lochen,

3 TrouS/orificios

1120067 KIT MACINE
ISTANTANEO CASADIO
/ PAIR GRINDERS
CASADIO
40090890000:
CASADIO SRL

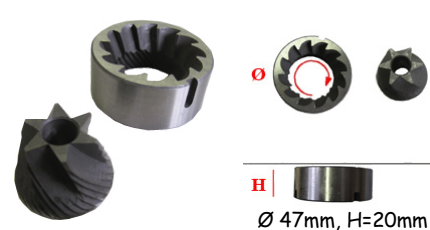

Ø 47mm, H=20mm

1120078 COPPIA
MACINE CONICHE
EROS D.68MM DX /
CONICAL PAIR
GRINDERS EROS
D.68MM DX



Ø 68mm, H=25mm

1120003 COPPIA
MACINE CONICHE
FAEMA /
CONICAL PAIR
GRINDERS FAEMA

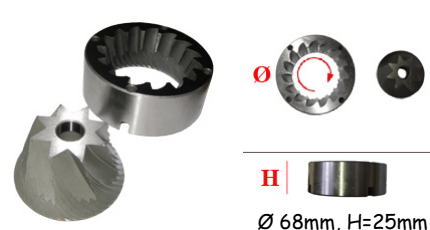

Ø 68mm, H=25mm

1120086 MACINA
CONICA FIOREZZATO
D.71/49 /
Conical grinder
FIOREZZATO D.71/49

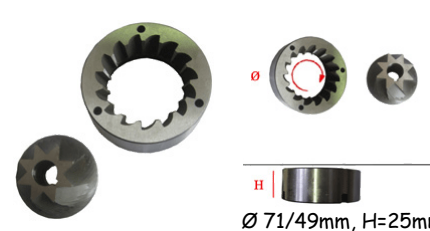

Ø 71/49mm, H=25mm

1120110 COPPIA
MACINE CONICHE 40-
63 MACAP /
CONICAL PAIR
GRINDERS 40-63
MACAP
C0004M122B:
MACAP SRL

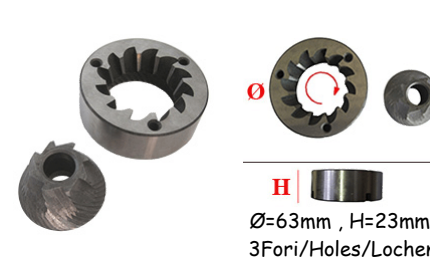

Ø=63mm , H=23mm,
3Fori/Holes/Lochen

1120072 COPPIA
MACINE CONICHE 49-
68 OR /
CONICAL PAIR
GRINDERS 49-68
C0004M121B:
MACAP SRL

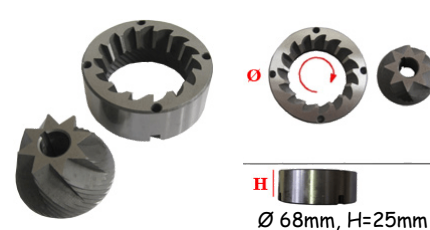

Ø 68mm, H=25mm

1120033 COPPIA
MACINE MAZZER
ROBUR TRIF. /
PAIR GRINDERS
MAZZER ROBUR
FMA00187CCQQ:
MAZZER LUIGI SRL

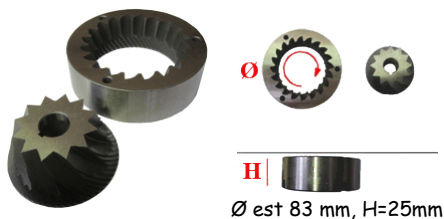

1120010 COPPIA
MACINE CONICHE D.38
DX /
CONICAL PAIR
GRINDERS D. 38 RIGHT
*****:
RANCILIO SPA



1120094 COPPIA
MACINE MAZZER
KONY MONOFASE NO /
PAIR GRINDERS
MAZZER KONY
MONOPHASE NO

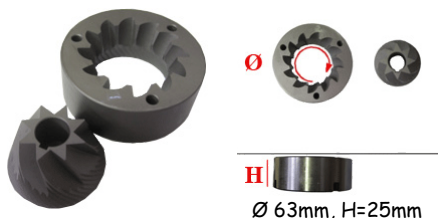

1120026 COPPIE
MACINE
ROSSI/CASADIO
CONICHE /
CONICAL PAIR
GRINDERS ROSSI

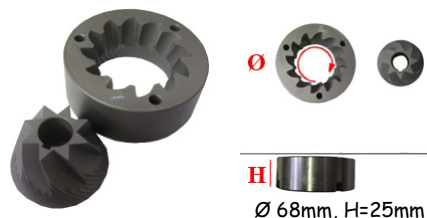

1120061 COPPIA
MACINE MAZZER
KONY MONOFASE /
PAIR GRINDERS
MAZZER KONY
MONOPHASE
191C:
MAZZER LUIGI SRL



1120016 COPPIA
MACINE CONICHE
48DX /
CONICAL PAIR
GRINDERS 48 RIGHT



1120095 MAZZER
KONY TRIFASE NO /
PAIR GRINDERS
MAZZER KONY
THREEPHASES NO

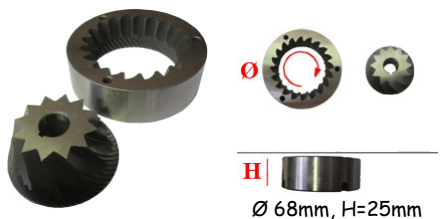

1120048 COPPIA
MACINE CONICHE SAN
MARCO /
CONICAL PAIR
GRINDERS SAN
MARCO



1120049 COPPIA
MACINE MAZZER
KONY TRIFASE /
CONICAL PAIR
GRINDERS MAZZER
FMA00192CCQQ:
MAZZER LUIGI SRL

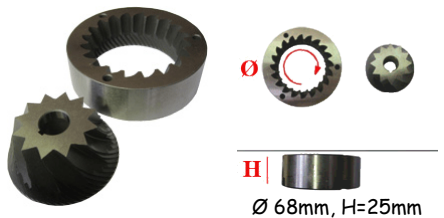

6101007 ADDOLCITO
RE MACCHINE
FAMIGLIA /
FAMILY MACHINE
WATER-SOFTNER
69000140:
RANCILIO SPA



1120070 COPPIA
MACINE MAZZER
ROBUR MONOFASE /
PAIR GRINDERS
MAZZER ROBUR
1PHASE
FMA00186CCQQ:
MAZZER LUIGI SRL

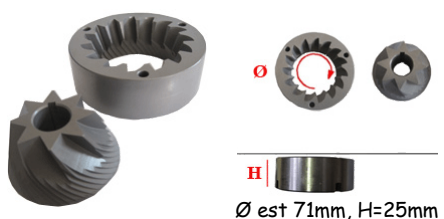

6101063 ADDOLCITO
RE FAMIGLIA RESINE
MACCHINE FAMIGLIA
GRC /
FAMILY MACHINE
WATER-SOFTNER
GRMC

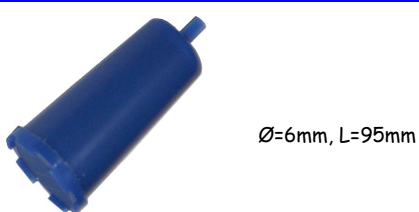

1120082 COPPIA
MACINE ROBUR
TRIFASE N.O. /
PAIR GRINDERS
ROBUR 3-PHASE N.O.



6101069 ADDOLCITO
RE FAMIGLIA RESINE
ALTO /
FAMILY MACHINE
WATER-SOFTNER

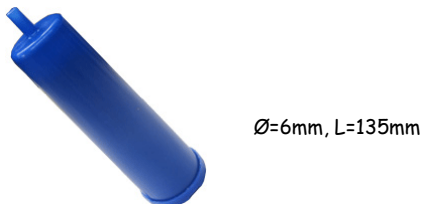

6101088 FILTRO
ADDOLCITORE ACQUA
/
WATER-SOFTNER
2260002000:
UGOLINI SPA



Ø=35X63mm,
Øportagomma=6mm

6101014 ADDOLCITO
RE 2 COLONNE /
2 COLUMNS WATER-
SOFTNER
640212:
COMENDA ALI SPA
38123250:
RANCILIO SPA



6101072 ADDOLCITO
RE 3 COLONNE /
3 COLUMNS WATER-
SOFTNER
33590:
HOONVED - ALI SPA



6101009 ADDOLCITO
RE 4 COLONNE /
4 COLUMNS WATER-
SOFTNER
117004:
ELETTROBAR
DIVISIONE DELLA
EUROTEC SRL
640209:
COMENDA ALI SPA
7641: A.T.A. SRL
171001:
ELETTROBAR
DIVISIONE DELLA
EUROTEC SRL
Z100P015:
S.V. ITALIA SRL
CERI47:
OMNIWASH SRL -
SOCIETA' A SOCIO
UNICO
902150:
SILANOS SRL
38123005:
RANCILIO SPA
DWD98: COLGED
10444: ADLER S.P.A.
9110002:
GRUPPO CIMBALI SPA
9120002:
GRUPPO CIMBALI SPA
977094000:
GRUPPO CIMBALI SPA
1148:
ARISTARCO KASTEL
SPA



6101112 ADDOLCITO
RE 4 COLON.
ENTR.CENT /
4 COLUMNS WATER-
SOFTNER - CENTRAL
ENTRANCE
H640216:
HOONVED - ALI SPA



6101086 ADDOLCITO
RE AUTOMATICO
CABINATO MINICAB
5LT 713 F79B A
VOLUME /
AUTOMATIC
VOLUMETRIC WATER
SOFTENER - CABINET
minicab 5 LT 713 F79B



P=425mm, H=465mm,
H aperto=560mm,
L=240mm,
KIT=6101087,
A=6101105, B=6101106,
C=6101107, D=6101102

6101089 ADDOLCITO
RE AUTOMATICO
CABINATO
VOLUMETRICO LT12
F79BS /
VOLUMETRIC WATER
SOFTENER - CABINET
LT 12 F79BS



P=530mm, H=600mm,
H aperto=700mm,
KIT=6101087,
L=330mm,
A=6101105, B=6101106,
C=6101107, D=6101102

6101105 VALVOLA
RUNXIN F79B VOLUME
3/4"UF/DF PISTONE
WBP CON ACCESSORI (
preset 5litri) /
VOLUMETRIC VALVE
RUNXIN F79B
3/4"UF/DF PISTON WBP
WITH ACCESSORIES
(preset 5L)



TRASFORMATORE=
6101103

6101103 TRASFORM
ATORE PER VALVOLA
TMF-EU 220/12 DC 1A /
TRANSFORMER FOR
VALVE TMF-EU 220/12
DC 1A



6101102 SCHEDA
ELETTRONICA DI
CONTROLLO PER
VALVOLA F79 /
ELECTRONIC
CONTROL BOARD FOR
F79 VALVE



6101106 SCHEDA
ELETTRONICA
DISPLAY PER
VALVOLA F79 /
DISPLAY P.C. BOARD
FOR F79 VALVE

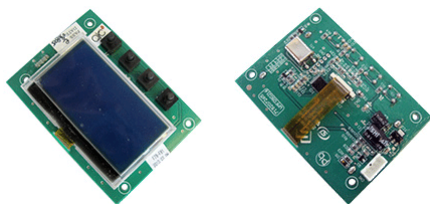

6101107 MOTORINO
PER F63C/F68C /
MOTOR FOR F63C/F68C



6101087 KIT
DISINFEZIONE DELLE
RESINE PER VALVOLA
RUNXIN /
KIT DISINFECTION
RESINS VALVE Runxin



6101101 COPPIA
RACCORDI 3/4"
CONTATORE PER
VALVOLA F79 /
PAIR METER
JUNCTION 3/4" FOR F79
VALVE



O-RING=6101099

6101109 KIT O-RING
TANK-PORTAGOMMA
BLFC DADO 3/8 /
KIT O-RING TANK-
RUBBER-HOLDER
BLFC NUT 3/8



G.PIATTA=19X5X3mm,
O-RING
Ø=72,5X5,12mm

6101099 O-RING
RACCORDO 3/4"
CONTATORE PER
VALVOLA F79 /
O-RING METER
JUNCTION 3/4" FOR F79
VALVE



Ø=19,3X2,62mm,
RACCORDO=6101101

6101104 TURBINA
CONTATORE PER
VALVOLA F79 /
METER FAN FOR F79
VALVE



H=13mm, Ø=23mm

6101036 ADDOLCITO
RE 8LT VOLUMETRICO
C/KIT DISINFEZIONE
RESINE /
VOLUMETRIC WATER-
SOFTNER 8LT

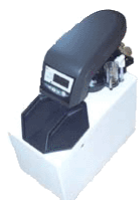

KIT
TESTATA=6101018,
KIT
MEMBRANE=6101019,
TIMER=1112314

6101035 ADDOLCITO
RE 8LT LOGIX
CABINATO 255/740 /
AUTOMATIC WATER-
SOFTNER 6L LOGIX

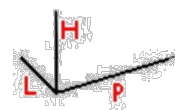

L=230mm, P=440 mm,
H=540 mm,
TIMER=1112314,
KIT
TESTATA=6101018,
KIT
MEMBRANE=6101019

6101037 ADDOLCITO
RE 12LT
VOLUMETRICO C/KIT
DISINFEZIONE RESINE
/
VOLUMETRIC WATER-
SOFTNER 12LT



6101049 ADDOLCITO
RE 12LT LOGIX
CABINATO 255/740 /
VOLUMETRIC WATER-
SOFTNER 12LT



6101018 KIT
TESTATA
ADDOLCITORE 6+1FIL.
/
WATER-SOFTNER
HEAD KIT 6 +1 FIL.



6101035, 6101061,
6101010, 6101011,
6101036

6101019 KIT
MEMBRANE PER AUT
255 /
MEMBRANE KIT FOR
AUT 255



6101035, 6101061,
6101010, 6101011,
6101036

6101071 AIR CHECK
KIT /
AIR CHECK KIT



6101022 TRASFORM
ATORE 220V 12V PER
AUTOTROL /
TRANSFORMER 220V
12V FOR AUTOTROL



6101065 ADDOLCITORE AUTOMATICO CAB. 5LT ELETTRONICO
ELECTRONIC AUTOMATIC WATER SOFTENER 5LT

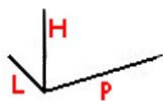

H=420mm, L= 215mm,
P=430mm,
gasket=6101082

6101082 KIT MEMBRANE (VALV. A DISCO PER 604) / MEMBRANES KIT x 6101065



6101081 KIT OR SCARICO E ENTRATA ADDOLCITORE AUTOMATICO / DRAIN AND INLET OR SET FOR AUTOMATIC WATER-SOFTENER



6101025 SACCO RESINA MONOSFERICA LT 25 / MONOSPHERICAL RESIN SACK 25 LT



6101026 BOMBOLA X ADDOLCITORE AUTOMATICO 5LT. / CYLINDER FOR AUTOMATIC WATER SOFTNER 5LT



6101039 DOLCEACQUA ANTICALCARE M1CP1 IN SCATOLA / DOLCEACQUA



6101040 TESTATA EVERPURE QL3B / WATER-SOFTNER HEAD EVERPURE QL3B



H=63mm

6101095 KIT TESTATA TWIN / KIT TWIN HEAD



FIL TER= 6101044

6101054 CARTUCCIA FILTRO PER MACCHINA PER CAFFE' ESO 7 / INSURICE CARTRIDGE FOR COFFEE MACHINE ESO 7



A= 6101051, B=6101052,
C= 6101040,
Capacity=2300 lt,
H=490mm, Ø=78mm

6101097 CARTUCCIA PER SCALEKLEEN PER ACQUA +2 RACCORDI 10-3/8" / CARTRIDGE FOR SANITIZING SCALEKLEEN



TESTATA=6101040,
CONFEZIONE 1KG=1143059

6101077 FILTRO DECARBONATTATORE PER ACQUA +2 RACCORDI 10-3/8" / WATERSOFTNERFILTE R + 2 CONNECTIONS 10-3/8"



5 KH= 14000lt,
10 KH=7000lt,
15 KH=4660lt,
20 KH= 3500lt,
25KH= 2800lt,
H=400mm,
Øbase=105mm

6101092 CARTUCCIA CON TESTATA BY PASS CLARIS ULTRA 170 / CARTRIDGE WITH HEAD BYPASS - CLARIS ULTRA 170



Ø=83mm,
H testata=85mm,
H=213mm

6101090 CARTUCCIA CON TESTATA BY PASS CLARIS ULTRA 500 / CARTRIDGE WITH HEAD BYPASS - CLARIS ULTRA 500



Ø=83mm,
H testata=85mm,
H=395mm

6101091 CARTUCCIA
CON TESTATA BY-
PASS CLARIS ULTRA
1000 /
CARTRIDGE WITH
HEAD BYPASS -
CLARIS ULTRA 1000



Ø=130mm,
H testata=85mm,
H=325mm

6101051 WATER
METER /
WATER METER



6101059 CONTALITR
I AQUAMETER
WATER+MORE /
WATER METER
WATER+MORE



6101052 FILTER
MONITOR /
FILTER MONITOR



6101073 CONTALITR
I ACQUA FREDDA
SECCO 3/4" /
COLD WATER METER
3/4"

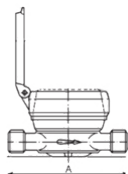

A=130mm

6101083 FILTRINO
DEPURATORE ACQUA
CASADIO /
Small filter CLEANER
WATER CASADIO
998064000:
CASADIO HBS SRL A
SOCIO UNICO



6101084 FILTRO
CASADIO /
FILTER CASADIO
998703000:
CASADIO HBS SRL A
SOCIO UNICO



6101076 ADDOLCITO
RE A SACCHETTO IN
SCATOLA /
WARTERSOFTNERBAG
IN A BOX



6101080 ADDOLCITO
RE COMPATTO 0,7LT. /
COMPACT WATER
SOFTNER 0,7LT
640222:
COMENDA ALI SPA



4118238 TRAMOGGI
A COMPLETA
CAIMANO /
COMPLETE HOPPER
CAIMANO
40C: ANFIM SAS



1121018 TRAMOGGI
A /
HOPPER COFFEE
1121018:
GRUPPO CIMBALI SPA



1121022 TRAMOGGI
A MAGNUM /
HOPPER MAGNUM
46581800:
GRUPPO CIMBALI SPA



1121023 CAMPANA
CON COPERCHIO M2 /
HOPPER WITH COVER
M2
C2470011: MACAP SRL



4118062 CAMPANA
CAFFE' NUOVA /
COFFE HOPPER NEW
C0007M113:
MACAP SRL



1121028 CAMPANA
CAFFE' M4 /
COFFEE HOPPER M4
C0007M161:
MACAP SRL



1121002 CAMPANA
CONICA S, JOLLY
COMPLETA /
HOPPER MAZZER
S00SCAE02AQQ:
MAZZER LUIGI SRL
PRCAMPMD:
MAGISTER SISTEMA



1121016 CAMPANA
MINI (320 GR.)
C/SERRANDA /
HOPPER MIN (320G)
WITH LOCK
SMISCAE07QQQ:
MAZZER LUIGI SRL



1121008 CAMPANA
ROBUR-MAJOR
COMPLETA /
COMPLETE HOPPER
ROBUR-MAJOR
S00SCAE07QQQ:
MAZZER LUIGI SRL



1121010 CAMPANA
MINI CON SERRANDA /
HOPPER MINI
SMISCAE04ex:
MAZZER LUIGI SRL



1121012 CAMPANA
KONY COMPLETA /
HOPPER KONY
SKOSCAE03QQQ:
MAZZER LUIGI SRL



4116428 CAMPANA
CILINDRICA S.
JOLLY/MAJOR /
CYLINDRICAL HOPPER
FOR JOLLY/MAJOR
S00SCAE04QQQ:
MAZZER LUIGI SRL



4118067 CAMPANA
CONICA JOLLY +
SERRANDA /
COMPLETE HOPPER
MAJOR
S00SCAE02AQQ:
MAZZER LUIGI SRL



1121014 TRAMOGGI
A COMPLETA 1KG /
COMPLETE HOPPER
1KG
G02+EB04+EB01:
OBEL SRL



1121019 TRAMOGGI
A KG.0,250 /
HOPPER kg.0, 250
DF2: OBEL SRL



1121020 TRAMOGGI
A KG.1,5 /
HOPPER KG.1, 5
G02: OBEL SRL



4118264 TRAMOGGI
A OBEL MODELLO
ZERO /
HOPPER MODEL ZERO
OBEL
MT02: OBEL SRL



cover=4118263

1121007 TRAMOGGI
A MD 40 COMPLETA /
COMPLETE HOPPER
MD 40
14030005:
RANCILIO SPA



1121001 TRAMOGGI
A MD50 COMPLETA /
COMPLET HOPPER
MD50
14030001:
RANCILIO SPA



1121003 TRAMOGGI
A MD 80 COMPLETA /
COMPLETE HOPPER
MD 80
14030011:
RANCILIO SPA



1121021 TRAMOGGI
A WEGA COMPLETA /
HOPPER COMPLETE
WEGA
WY28357001:
WEGA MACCHINE
PER CAFFE' SRL



1121027 CAMPANA
MACINADOSATORE
TANZANIA /
TANZANIA COFFEE
GRINDER HOPPER



4118237 COPERCHIO
DOSATORE /
COVER HOPPER
5: ANFIM SAS



4118292 COPERCHIO
TRAMOGGIA /
COVER HOPPER
44: ANFIM SAS



4118247 COPERCHIO
TRAMOGGIA /
HOPPER COVER



4118027 COPERCHIO
CAMPANA CAFFE'
NEW MACAP /
HOPPER COVER
MACAP
C0007M114:
MACAP SRL



4118034 COPERCHIO
DOSATORE MD
MACAP /
DOSING COVER MD
MACAP
C0007M105:
MACAP SRL



4118341 PIATTINO
CPS C18 /
CPS C18 DRIP TRAY
C0007CPS056C18:
MACAP SRL



4118047 COPERCHIO
DOSATORE MAZZER /
DOSING COVER
MAZZER
S000COD02QQQ:
MAZZER LUIGI SRL

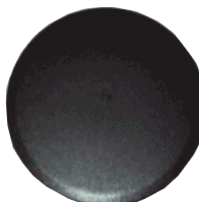

4118068 COPERCHIO
CAMPANA MINI /
HOPPER COVER MINI
SMI0COD01QQQ:
MAZZER LUIGI SRL



4118076 COPERCHIO
CAMPANA /
HOPPER COVER
S000COD01AQQ:
MAZZER LUIGI SRL



4118263 COPERCHIO
TRAMOGGIA
MODELLO ZERO /
HOPPER COVER
MODEL ZERO
MTO1: OBEL SRL

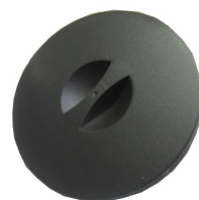

4118259 COPERCHIO
TRAMOGGIA /
HOPPER COVER
EB01: OBEL SRL

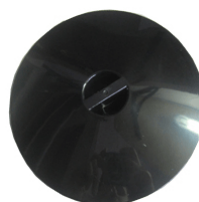

4118268 COPERCHIO
DOSATORE /
COVER DISPENSER
EB051: OBEL SRL



4118312 COPERCHIO
DOSATORE DIAM.95 /
DOSER COVER
DIAM.95
DF51M: OBEL SRL



4118282 VENTOLA
CAMPANA M2 /
FAN HOPPER M2
C247003: **MACAP SRL**



4118086 SERRANDA
CAMPANA TIPO
NUOVO /
HOPPER LOCK
SMI05E01AQQ:
MAZZER LUIGI SRL



4118187 SERRANDA
BOCCHETTONE
CAMPANA TIPO
VECCHIO /
DAMPER FOR HOPPER
OLD VERSION
S0005E01QQQ:
MAZZER LUIGI SRL



4118262 SERRANDA
BOCCHETTONE
ROBUR-KONY-MAJOR /
DAMPER FOR DRAIN
ROBUR-KONY-MAJOR
S0005E02AQQ:
MAZZER LUIGI SRL



4118303 BOCCHETT
ONE + SERRANDA
CAMPANA
MACINADOSATORE
ZERO OBEL /
FILLER + SHUTTER
HOPPER GRINDER -
ZERO OBEL
MT102IST:
OBEL SRL



4118193 APPOGGIO
PORTAFILTRO MC99 /
FILTERHOLDER
SUPPORT MC99



4118300 FORCELLA
M2 /
FORK M2
C247042: **MACAP SRL**



4118281 FORCELLA
M2D /
FORK M2D
C247022: **MACAP SRL**



4118196 FORCHETTA
/
FORK
S000F0B02CQQ:
MAZZER LUIGI SRL



4118046 FORCHETTA
LUNGA X PRESSINO
MAZZER /
LONG FORK FOR
TAMPER
S000F0B04BQQ:
MAZZER LUIGI SRL



4118233 FORCHETTA
LUNGA MJ-SJ
ELETTRONICO /
LONG FORK
ELECTRONIC MJ-SJ
S000F0B15QQQ:
MAZZER LUIGI SRL



4118232 FORCHETTA
1 E 2 DOSI /
FORK 1 AND 2 DOSES
S000F0B08BQQ:
MAZZER LUIGI SRL



4118267 FORCELLA
PORTAFILTRO /
FORK FILTERHOLDER
EB033: **OBEL SRL**



4118305 FORCELLA
PORTA FILTRO /
FILTER HOLDER FORK
DF33: **OBEL SRL**



4118025 FORCHETTA
PORTAFILTRO MD /
FORK FOR FILTER
HOLDER MD
21210501:
RANCILIO SPA



4118188 PIATTINO
MX NUOVO /
SAUCER NEW MX
C0007M1031:
MACAP SRL



4118051 PIATTINO
SUPER JOLLY-MAJOR-
KONY NUOVO /
PLATE SUPER JOLLY
NEW
SMIOPIB03QQQ:
MAZZER LUIGI SRL



4118058 PIATTINO
MINI /
DISH MINI
SMIOPIB01AQQEX:
MAZZER LUIGI SRL



4118207 PIATTINO
MINI NEW (PLASTICA)
/
NEW MINI PLASTIC
SAUCER
SMIOPIB02QQQ:
MAZZER LUIGI SRL



4118297 RACCOGLI
AFFE' MACININO ABS /
DRIP TRAY GRINDER
ABS
05000506:
NUOVA SIMONELLI
SPA



4118272 VASCHETT
A RACCOGLI CAFFE' /
PAN COLLECTOR
COFFEE
EB022: OBEL SRL



4118236 VETRO
DOSATORE PER HAUS /
CYLINDER FOR HAUS
202: ANFIM SAS



4118072 PLEXIGLAS
(2652) /
PLEXIGLAS (2652)
28050:
CMA MACCHINE PER
CAFFE' SRL
0142900002:
BRASILIA SPA



4118090 ANELLO
DOSATORE MX /
TANK GROUND
COFFEE DISPENSER
MX
C0007M106:
MACAP SRL



4118245 CILINDRO
DOSATORE MJ-RO-RL-
SK /
CYLINDER MJ-RO-RL-
SK
S000CIA03QQQ:
MAZZER LUIGI SRL



4118135 CILINDRO
DOSATORE /
CYLINDER DISPENSER
S000CIA01QQQ:
MAZZER LUIGI SRL



4118194 CILINDRO
DOSATORE MINI /
CYLINDER MINI
S000CIA02QQQ:
MAZZER LUIGI SRL



4118271 CILINDRO
DOSATORE /
CYLINDER DOSATORE
EB094: OBEL SRL

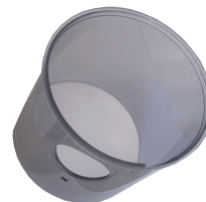

4118019 SERBATOIO
MACINATO MD 50 /
CONTAINER FOR
COFFEE DOSER MD 50
38125008A:
RANCILIO SPA



4118063 GRUPPO
DOSATORE MINI
MANUALE /
MAN. DOSING KIT
MINI
SMISGRA02BQQ:
MAZZER LUIGI SRL



4118285 GRUPPO
DOSATORE SUPER
JOLLY AUTOMATICO /
DOSING UNIT
AUTOMATIC SUPER
JOLLY
SSJSGRL03QQQ:
MAZZER LUIGI SRL



4118169 GRUPPO
DOS. S.JOLLY CON
CONTACOLPI /
DOSING UNIT JOLLY
WITH COUNTER
SSJSGRA05/Aex:
MAZZER LUIGI SRL



Ø=12mm

4118172 GRUPPO
DOSATORE MAJOR
MANUALE /
MAJOR MANUAL
DOSING UNIT
SMJSGRA02AAQ:
MAZZER LUIGI SRL



4118088 TUBO
DOSATORE
SUPERIORE JOLLY
MANUALE /
JOLLY MANUAL
DISPENSER TUBE TOP
SSJ0TUA03BQQ:
MAZZER LUIGI SRL

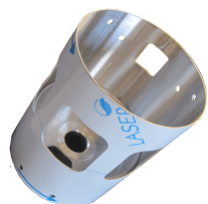

4118185 GRUPPO
DOSATORE ROBUR
ROYAL STARK /
DOSING UNIT FOR
ROBUR ROYAL STARK
SROSGRL04QQQ:
MAZZER LUIGI SRL



4118261 DOSATORE
COMP.CON TRIANG.-
CIL.-COP. /
DISPENSER COMPLETE
WITH TRIANG.-CIL-
COP.
EB92: OBEL SRL



4118036 STELLA
C/MOZZO MX-R8 MCP /
STAR MX-R8 MCP
C0002M1241:
MACAP SRL



4118065 STELLA
MASCHIO /
MALE STAR
S000STA02BQQ:
MAZZER LUIGI SRL



4118049 STELLA
FEMMINA MZZR /
STAR MAZZER
S000STA03BQQ:
MAZZER LUIGI SRL



4118070 STELLA
SMUOVICAFFE' CON
ASTINA S.J. /
STAR FOR COFFEE
SSJSSTA04QQQ:
MAZZER LUIGI SRL



4118302 STELLA
SMUOVICAFFE' CON
ASTINA MAJOR /
STAR MOVEMENT
COFFEE WITH ROD -
MAJOR
SMJSSTA04QQQ:
MAZZER LUIGI SRL



4118211 STELLA
SMUOVICAFFE' CON
ASTINA MINI /
STAR MOVEMENT
COFFEE WITH ROD
MINI
SMISSTA04QQQ:
MAZZER LUIGI SRL



4118139 SET STELLA
MAGGIORATA MAJOR
/
STAR SET MAJOR
S005GRA07AQQ:
MAZZER LUIGI SRL

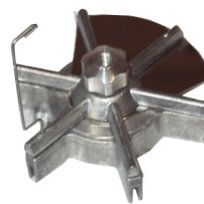

4118304 STELLA
MAGGIORATA +
MANOPOLINA /
STAR WITH
ADJUSTMENT KNOB
S005GRA08AQQ:
MAZZER LUIGI SPA



4118329 STELLA
INFERIORE /
LOWER STAR **EB062:**
OBEL SRL



4118309 REGOLATO
RE MICROMETRICO
COMPL. /
COMPLETE
MICROMETRIC
ADJUSTER
C0007M11700:
MACAP SRL



4118186 FONDO
DOSATORE /
FUND DISPENSER
S000FOA03QQQ:
MAZZER LUIGI SRL



4118087 FONDO
DOSATORE
COMPLETO /
DOSING BOTTOM
S00SFOA01QQQ:
MAZZER LUIGI SRL



4118326 FONDELLO
DOSATORE /
BOTTOM DOSER
EB093: OBEL SRL



4118209 POTENZIOM
ETRO MULTIGIRI 10
CABLATO ROSSO /
Multi-turn potentiometer
10 WIRED RED
S000POT02AQQ:
MAZZER LUIGI SRL



4118075 PORTAMAC.
ROTAN.X
MACIN.ORRIZ.(4984) /
GRINDERS HOLDER
(4984)
28259:
**CMA MACCHINE PER
CAFFE' SRL**
0207700004:
BRASILIA SPA



4118159 PORTAMACI
NE INFERIORE
MAJOR/ROYAL /
LOWER PAIR
GRINDERS HOLDER
MAJOR/ROYAL
SMJ0POA07QQQ:
MAZZER LUIGI SRL



4118204 PORTAMACI
NE INFERIORE SUPER
JOLLY /
GRINDING BURR
HOLDER TYPE JOLLY
SSJ0POA04QQQ:
MAZZER LUIGI SRL



4118153 FLANGIA
DISCO STAZIONARIO /
STATIONARY DISC
FLANGE
20025:
DITTING
MASCHINEN AG

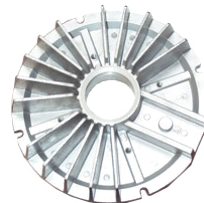

4118154 FLANGIA
DISCO ROTANTE /
ROTATING DISC
FLANGE

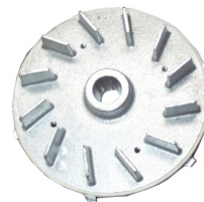

4118291 CORPO
MACININO x SL+SP+DR
/
BODY GRINDER x SL-
SP-DR
462: ANFIM SAS

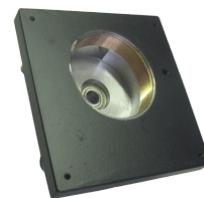

4118028 FERMAMAC
INE MACAP /
STOP GRINDERS PIN
MACAP
C0002M102:
MACAP SRL



4118039 MANIGLIA
DOSATORE MCP /
DOSING COFEEEE
GRINDER HANDLE
MCP
C0002M103:
MACAP SRL



4118206 LEVA
ORIZZ.
AUTOM.COMPLETA
MXA /
COMPLETE LEVER
MXA
C0007M150:
MACAP SRL



4118320 LEVA
COMPLETA CPS /
COMPLETE LEVER CPS
C0007CPS044:
MACAP SRL



4118344 LEVA
COMPLETA EASY
TAMPER /
EASY TAMPER
COMPLETE LEVER
S00SLEA05/QQQ:
MAZZER LUIGI SPA



4118299 MANETTIN
O DOSATORE /
LEVER DISPENSER
EB029P: OBEL SRL



4118004 LEVA
MACINADATORE
MD40/50/80 /
COFFEE GRINDER
LEVER MD 40/50/80
22105001:
RANCILIO SPA



4118005 FERMO
GHIERA MD 50 /
RING HOLDER MD 50
22208501:
RANCILIO SPA



4118307 POMOLO
PRESSINO Inferiore Ø 52
/
KNOB TAMPER Lower
Ø 52
19P: ANFIM SRL



4118308 POMOLO
PRESSINO Inferiore Ø56
/
KNOB TAMPER Lower
Ø 56
19G: ANFIM SRL



4118042 SUPPORTO
PRESSINO NUOVO
MCP /
TAMPER HOLDER FOR
NEW MCP
C0007M1071:
MACAP SRL



4118077 PRESSINO
D.54,5MM /
DAMPNER D.54,5MM
S000PRA02QQQ:
MAZZER LUIGI SRL



4118052 PRESSINO
MAZZER D.53MM /
TAMPER MAZZER
D.53MM
S000PRA02QAQ:
MAZZER LUIGI SRL



4118053 PRESSINO
MAZZER D.57,5MM /
TAMPER MAZZER
D.57,5MM
S000PRA02QCQ:
MAZZER LUIGI SRL



4118044 PRESSINO
D.51,5 MCP /
TAMPER D.51,5 MCP
C0007M102B:
MACAP SRL



4118043 PRESSINO
D.57 MCP /
TAMPER D.57 MCP
C0007M102A:
MACAP SRL



4118324 PRESSACAF
FE' DIAMETRO 52mm /
TAMPER DIAMETER
52mm
EB03752:
OBEL SRL



Ø=52mm

4118258 PRESSACAF
FE' d.56 mm /
TAMPER
EB037: OBEL SRL



Ø=56mm

4118332 POMOLO
SUPERIORE
PRESSACAFFE' /
KNOB TAMPER
SUPERIOR
EB047: **OBEL SRL**



ØFiletto=7mm,
Ø=40mm

4118335 PRESSINO d.
52 CPS (ART 12A) /
TAMPER D.52 CPS (ART
12A)
CO001CPS042A:
MACAP SRL



4118280 PRESSINO d.
53 CPS (ART 12C) /
TAMPER d. 53 CPS (ART
12C)
CO001CPS042C:
MACAP SRL



4118276 PRESSINO d.
57,5 CPS (ART 12) /
TAMPER d. 57.5 CPS
MACAP
CO001CPS042:
MACAP SRL



4118278 PIATTELLO
D. 53X19 mm AISI304 /
PLATE D.53X19 304
stainless steel

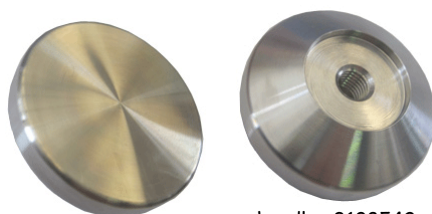

handle= 3108542

4118277 PIATTELLO
D.58X19 AISI 304 /
PLATE D.58X19 304
stainless steel

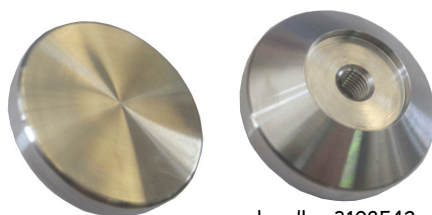

handle= 3108542

4118284 PRESSINO
ESPRESSOTECNICA
D53 mm DISCO INOX -
IMPUGNATURA
ALLUMINIO NERO /
TAMPER
"ESPRESSOTECNICA"
D53 mm DISK
STAINLESS STEEL
ALUMINUM HANDLE-
BLACK

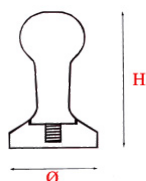

H=92mm, Ø = 53 mm

4118283 PRESSINO
ESPRESSOTECNICA
D58 mm DISCO INOX -
IMPUGNATURA
ALLUMINIO NERO /
TAMPER
"ESPRESSOTECNICA"
D58 mm DISK
STAINLESS STEEL
ALUMINUM HANDLE-
BLACK

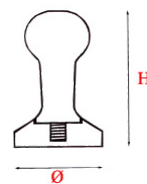

H=92mm, Ø = 58 mm

4118045 PRESSINO A
MOLLA X
PORTAFILTRO
RANCILIO/FAEMA /
TAMPER FOR
RANCILIO/FAEMA
S00SPRA04ACQ:
MAZZER LUIGI SRL



4118249 PACCO
AVVOLTO S.JOLLY-
KONY 220-240/50/1 /
STATOR S.JOLLY-
KONY 220-240/50/1
SSJSPAEO1QQQ:
MAZZER LUIGI SRL

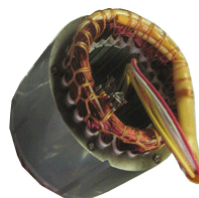

4118250 ROTORE
KONY /
ROTOR KONY
SKOOROA01QQQ:
MAZZER LUIGI SRL



4118163 CONTACOL
PI COMPLETO NEW /
COMPLETE NEW
COUNTER
S00SCOB02QQQ:
MAZZER LUIGI SRL



4118219 CONTACOL
PI M 20 + LEV. /
COUNTER M 20
69000085:
RANCILIO SPA



4118060 SCATOLA
MICRO MXA COMP. /
COMPLETE MICRO
BOX MXA
CO007M139A:
MACAP SRL



4118069 MICROSCAT
TO SUPERIORE /
MICROSWITCH
S005MIA09QQQex:
MAZZER LUIGI SRL



4118251 STAFFA
FISSAGGIO SCATOLA
MICRO /
BRACKET MICRO BOX



4118252 SCATOLA
MICRO /
MICRO BOX



4118253 COPERCHIO
SCATOLA MICRO /
MICRO BOX COVER



4118266 SPORTELLINO
COPRI
MICROINTERRUTTORE
/
DOOR MICRO SWITCH
COVER
EB087: OBEL SRL



4118310 CUSTODIA
MICRO IN PC-
COMPLETA S/MICRO /
MICROSWITCH
HOLDER WITH LID
EB0861: OBEL SRL



4118231 BASE MITO /
BASE GRINDER MITO
MT7: OBEL SRL



4118265 CUSTODIA
MICROINTERRUTTORE
/
MICRO SWITCH
HOUSING
EB086: OBEL SRL



4118254 ASSIEME
ARRESTO
AUTOMATICO. k322 /
AUTOMATIC BLOCK
K322

WY28002007:
WEGA MACCHINE
PER CAFFE' SRL



4118234 ASSIEME
ARRESTO AUTOM.
K322 MAC.ASC. /
AUTOMATIC BLOCK
K322

WY2800207:
WEGA MACCHINE
PER CAFFE' SRL



4118240 PERNO
SALTARELLO
ZIGRINATO /
PIN

60: ANFIM SAS



4118342 ART 8
ALBERINO CPS /
SHAFT CPS
C0004CPS038:

MACAP SRL



L=100mm

4118323 PERNO
BLOCCA
BOCCHETTONE / PIN
FOR HOPPER LOCK

SROOPEA02AQQ:
MAZZER LUIGI SPA



4118241 CAPPuccio
protezione saltarello in
neoprene /
CAP

61: ANFIM SAS



4118260 VENTOLA
CAMPANA CAFFE' /
FAN HOPPER COFFEE

C0007M101C:
MACAP SRL



4118032 PIEDINO
TENERO MCP /

FOOT MCP
C000716140:
MACAP SRL



4118203 CRICCO
DOSATORE SINISTRO /
PAWL SX

C0002M107:
MACAP SRL



4118038 CRICCO
DOSATORE MCP /
DOSING WHOLE PAWL
MCP

C0002M106:
MACAP SRL



4118316 ART 11
REGOLATORE MOLLA
CPS /
REGULATOR SPRING
CPS

C0004CPS041:
MACAP SRL



4118317 ART 10
SUPPORTO MOLLA
CPS /
SUPPORT SPRING CPS

C0001CPS040:
MACAP SRL

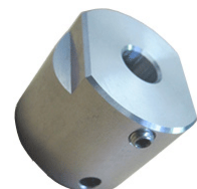

4118318 ART 3
INGRANAGGIO CPS /
GEAR CPS

C0004CPS033:
MACAP SRL



4118319 ART 13A
SUPPORTO
INGRANAGGI CPS /
SUPPORT GEAR CPS

C0001CPS050A:
MACAP SRL



4118321 ART 4
SUPPORTO LEVA CPS /
SUPPORT LEVER CPS

C0001CPS034:
MACAP SRL

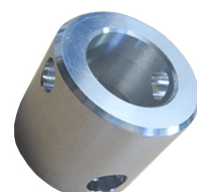

4118337 CAPPuccio
TRASCINATORE P206 /
HOOD DRIVER P 206

C0004S812:
MACAP SRL



4118340 NASELLO
MC6 /
NIB MC6

C0002M115: MACAP
SRL



4118040 MOLLA
TORSIONE DOSATORE
/

SPRING MCP
C0008M102:
MACAP SRL

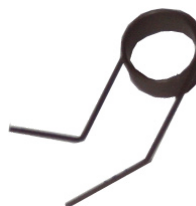

4118029 FORCELLA
APPOGGIA PRESSINO
MACAP /
FORK FOR TAMPER

C0004M109:
MACAP SRL



4118181 MOLLA
MICOSCATTO
INFERIORE /
MICRO SPRING STEP
LOWER

S000MOB06QQQ:
MAZZER LUGI SRL



4118270 PIATTELLO
RACCOGLITORE /
PLATE COLLECTOR

MT3: OBEL SRL

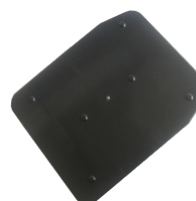

4118269 COPRIMANE
TTINO DOSATORE /
COVER HAND LEVER
DISPENSER

EB029A: OBEL SRL



4118313 COPRIMANE
TTINO DOSATORE -
OBEL- /
LEVER COVER OBEL
DF28: **OBEL SRL**

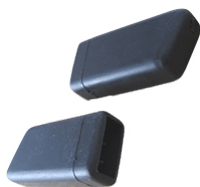

4118074 LAMIERINO
CAMP.R80/VIP
(S3352.10) /
BLADE FOR HOPPER
R80/VIP (S3352.10)
28190:
CMA MACCHINE PER
CAFFE' SRL
0177104001:
BRASILIA SPA



4118314 DIAFRAMM
A /
DIAPHRAGM FOR
DOSER
EB060: **OBEL SRL**



4118081 REGOLATO
RE CAFFE' / COFFEE
KNOB
C0007M123:
MACAP SRL



4118273 SFERE CPS
KIT DA 6 PEZZI /

BALLS OF 6 PIECES
KIT CPS
C0001CPS043:
MACAP SRL



4118200 PRESA
D'ARIA
MACINADOSATORE /
AIR INTAKE
C0007M141: **MACAP
SRL**



4118275 ART 7
CILINDRO CON FORI
CPS /
CYLINDER WITH
HOLES CPS
C0004CPS037:
MACAP SRL



4118214 IMBUTO
MINI ELETTRONICO /
FUNNEL FOR MINI
ELECTRONIC
S000IMB08QQQ:
MAZZER LUIGI SRL

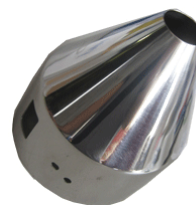

4118215 IMBUTO
MAJOR-ROBUR-
ROYAL ELETTRONICO
/
FUNNEL FOR
MAJOR/ROBUR-ROYAL
ELECTRONIC
S000IMB02QQQ:
MAZZER LUIGI SRL



4118288 GHIERA
REGOLAZIONE ROBUR
+ FERMO /
RING NUT SETTING
Robur
SRO0GHA01QQQ:
MAZZER LUIGI SRL

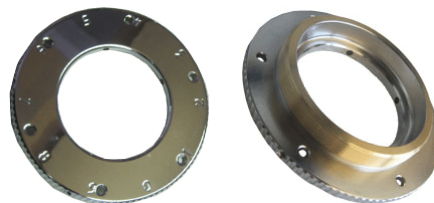

3124142 GHIERA
REGOLAZIONE
S.JOLLY-KONY-MINI
/
REGULATION NUT
S.JOLLY-KONY-MINI
SSJ0GHA02QQQ:
MAZZER LUIGI SRL



4118325 REGOLATO
RE /
REGULATOR
EB053: **OBEL SRL**

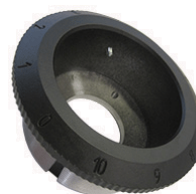

4118327 GOMMA
MOTORE ø 140 mm /
RUBBER MOTOR ø 140
mm
MT85: **OBEL SRL**



4118328 GOMMA
MOTORE MAXI /
GASKET FOR MOTOR
MAXI
G85: **OBEL SRL**



4118333 GUARNIZIONE GOMMA / TRAMOGGIA / SEAL RUBBER HOPPER
G103G: **OBEL SRL**



4118339 PROLUNGA GOMMA / RUBBER EXTENSION
G102: **OBEL SRL**

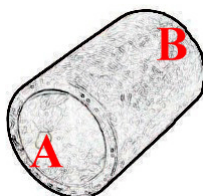

B=38mm, L= 43mm,
A=35mm

4118315 ANELLO COPRIVITI ø 126 mm / SCREW COVER RING NUT ø 126 mm
EB085: **OBEL SRL**



DIMENSIONS
125X80x11

4118330 POMOLO REGOLAZ. DOSATURA / DOSE ADJUSTMENT KNOB
EB048: **OBEL SRL**



4118279 CAMPANA LEVA OTTONE CRM / BELL HANDLE BRASS Chrome



4118178 PIATTINO ROBUR/ROYAL / DRIP TRAY ROBUR/ROYAL
SROOPIB02QQQ:
MAZZER LUIGI SRL



4118235 "RETINA PASSAGGIO CAFFE" TIPO "D" / RETINAL STEP COFFEE TYPE "D"
S000RETO4QQQ:
MAZZER LUIGI SRL

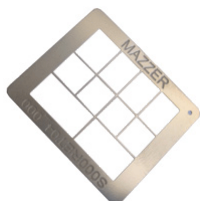

4118242 "RETINA PASSAGGIO CAFFE" TIPO "C" / RETINAL STEP COFFEE TYPE "C"
S000RETO3QQQ:
MAZZER LUIGI SRL

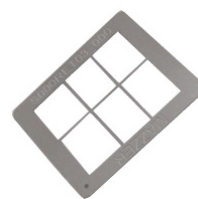

4118248 FRONTALE COPRIMOTORE S.JOLLY(DROGH./EL.) / FRONT ENGINE COVER S.JOLLY (DROGH. / EL.)
SSJOFRA04AQQ:
MAZZER LUIGI SRL

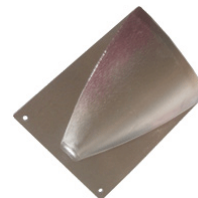

4118246 PORTAMACINE SUP. ROBUR MONOFASE / GRINDERS HOLDER ROBUR ONE-PHASE
SROOPOA08AQQ:
MAZZER LUIGI SRL

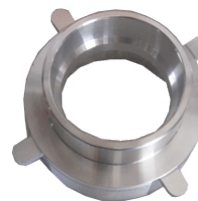

4118157 PROTEZIONE USCITA CAFFE' SJ-MJ-RO-RL-SK / COFFEE PROTECTION SJ-MJ-RO-RL-SK
S000PRB02QQQ:
MAZZER LUIGI SRL



4118213 PROTEZIONE USCITA CAFFE' MINI / COFFEE OUTLET GUARD MINI
SMIOPRB01QQQ:
MAZZER LUIGI SRL



4118082 NASELLO DOSATORE / NOSE DISPENSER
S000NAA01AQQ:
MAZZER LUIGI SRL



4118287 CHIAVETTA 3X3X30 UNI 6604A / UNI KEY 3X3X30 6604A
SOCH30030QQQ:
MAZZER LUIGI SRL



4118289 DADO BLOCCA GHIERA / HOLDER NUT FOR RING
SROODAG01AQQ:
MAZZER LUIGI SRL



4118290 PERNO
BLOCCA GHIERA /
PIN LOCK RING NUT
SROOPEA03QQQ:
MAZZER LUIGI SRL



4118083 TARGA
TIMER /
PLAQUE TIMER
S000TAA03QQQ:
MAZZER LUIGI SRL

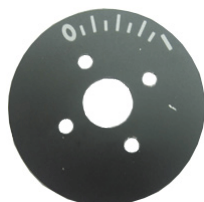

4118226 CUSCINETT
O 6202 DDU CM /
BEARING 6202 DDU CM
S000CUA07A:
MAZZER LUIGI SRL



4118091 FERMA
TIMER /
TIMER STOP
S000FEA01AQQ:
MAZZER LUIGI SRL



4118137 GRUPPO
BOCCHETTA
DROGHERIA /
GROCERIES SMALL
OPENING GROUP
S005GRC01QQQ:
MAZZER LUIGI SRL



4118145 CRICCO /
RATCHETING
S000CRA01EX:
MAZZER LUIGI SRL



4118311 PERNO
ARRESTO /
LOKING PIN
EBO6: OBEL SRL



4118295 PERNO
ARRESTO /
PIN STOP
G06: OBEL SRL



4118223 PROTEZ.BA
SAM.MD64/N /
PROTECTION
32920030:
RANCILIO SPA

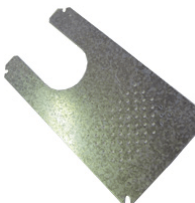

4118155 ASSIEME
TUBO GOMMA /
RUBBER TUBE
ASSEMBLY
40197:
DITTING
MASCHINEN AG



4118156 VASCHETT
A NERA /
TRAY BLACK
30205:
DITTING
MASCHINEN AG



4118174 FRUSTA PER
MESCOLATRICE DA
10L /
MIXER WHIP 10L
653269:
ELECTROLUX
PROFESSIONAL
S.P.A.



1106025 TERMOMET
RO DIGITALE 50+260° /
DIGITAL
THERMOMETER
50+260°
1106025:
UNIVERSALE



1106131 TERMOMET
RO INFRAROSSI -
18+260° /
INFRA-RED
THERMOMETER -
18+260°
:



4117027 SET
ALESATORI 12 PEZZI /
REAMERS KIT 12
PIECES



6103004 BILANCIA
TASCABILE 150GR. DIV
0,05 /
DIGITAL SCALE 150GR.
DIV 0,05



6103009 BILANCIA
DIGITALE 100GR. MOD.
TANITA /
DIGITAL SCALE 100GR.
MOD. TANITA



6103012 PHMETRO
DIGITALE USO
ALIMENTARE /
DIGITAL PHMETER



6103015 PHMETRO
DIGITALE PORTATILE
CON SONDA /
DIGITAL PHMETER
WITH PROBE



6103007 LAMPADA
FLUORESCENTE RS-8 /
LAMPE RS-8





Corso Sempione 238/8 - 21052 Busto Arsizio -VA- Italy
phone 0039 0331 324053 - fax 0039 0331 671063

C.F. - P.IVA IT 02980880120

Società Unipersonale - Cap. Soc. € 10.000,00 i.v. - Iscr. Reg. Imprese di VA 02980880120

info@sep-spareparts.com -- www.sep-spareparts.com