

S&P



Cooking

**Cooking Catalogue
2017**



S&P

**Corso Sempione 238/8
21052 Busto Arsizio (VA)
ITALY**

phone: +39.0331.324053



fax: +39.0331.671063

e-mail: info@sep-spareparts.com

web pages: www.sep-spareparts.com



Come ordinare, how to order, comment commander, Wie konnes Sie bestellen, Como ordinar :

Phone: +39.0331.324053

Fax : +39.0331.671063

E-mail: info.sep-spareparts.com

Ricambi fuori catalogo

preghiamo, nel limite del possibile, di fornire i seguenti dati:

Nome del costruttore

Modello dell'apparecchiatura

Numero matricola ed anno costruzione

Spare parts out of catalogue

Please give us the following data:

Manufacturer's name

Machine's model

Serial number and manufacture year

Pièces hors catalogue

Veillez nous fournir les données suivantes :

Nome du constructeur

Model de la machine

Numéro de série et année de fabrication

Ersatzteile, die im Katalog nicht enthalten sind

Im Rahmen des Möglichen, bitten wir Sie, um folgenden daten uns mitzuteilen und zwar:

Name des Herstellers

Maschinenmodell

Fabriknummer und Herstellungsjahr

Repuestos fuera del catalogo

Les pedimos que en el limite de lo posible proporcionar los siguientes datos:

Nombre del constructor

Modelo del aparato

Numero de matricula y año de construcción

In questo catalogo sono raffigurati i materiali più rappresentativi e di maggior importanza; a richiesta sono disponibili gli articoli specifici per i marchi più diffusi.

This catalogue shows the most representative and important materials; at request, the specific items of the well-known stamps are available.

Ce catalogue montre les matériels plus représentatifs et de majeure importance; à requête, les articles spécifiques des maisons plus connue sont disponibles.

In diesem Katalog sind die wichtigsten Artikel dargestellt; auf Wunsch sind bestimmte Artikel der meistverbreitesten Firmen verfügbare.

En este catalogo se presentan los materiales más representativos y de mayor importancia; sobre pedido están disponibles los artículos específicos de las marcas más conocidas.

Le informazioni contenute in questo catalogo sono soggette a modifiche senza preavviso.

Nessuna parte di questo catalogo può essere riprodotta in qualsiasi forma o mezzo elettronico o meccanico, per alcun uso, senza il permesso scritto della S&P.

The information you find in this catalogue can be modified without advise.

This catalogue cannot be reproduced in any form and elettronical or mechanical means without the express written authorisation of S&P.

Les renseignements de ce catalogue peuvent être modifiés sans avis.

Ce catalogue ne peut pas être reproduit avec n'importe quelle forme or moyen électronique ou mécanique sans autorisation écrite exprimée de la S&P.

Die in diesem Katalog enthaltenen Angaben können ohne Vorbehalten geändert werden.

Ohne schriftliche Genehmigung von der Firma S&P, kann keine seite von diesem Handbuch entweder elektronisch oder mechanisch für kein Zeil vervielfältigt werden.

Las informaciones contenidas en este catalogo estan sujetas a modifिकास sin pre aviso.

Ninguna parte de este catalogo puede ser reproducida en cualquier forma o medio electronico o mecanico para algun uso sin el permiso escrito de la S&P.

Condizioni generali

Prezzi: Le quotazioni esposte nei listini si intendono indicative e possono essere soggette a variazioni senza preavviso.

I prezzi non comprendono spese di trasporto, imballaggio, IVA ed eventuali altri oneri accessori; le spese per emissione di ricevute bancarie e tratte sono a carico del Cliente.

Resa della merce: Il materiale si intende venduto franco ns. magazzino, e pertanto l'obbligo di fornitura si intende assolto con la presa in consegna della merce da parte del trasportatore. La merce viaggia sempre, anche in caso di porto franco destino, a rischio e pericolo del Committente e, salvo precise disposizioni da parte del medesimo, l'inoltro della merce a destino verrà effettuato nel modo da noi ritenuto più idoneo, senza che ciò comporti alcuna responsabilità da parte della S&P, che non potrà essere ritenuta responsabile di eventuali ritardi o disguidi causati dal vettore.

Reclami: La S&P agisce quale rivenditore di materiali prodotti da terzi, non può pertanto assumersi responsabilità riferita ad eventuali difetti degli stessi. Qualsiasi reclamo dovrà essere indirizzato ad S&P con lettera o fax entro e non oltre otto (8) giorni dal ricevimento della merce.

Responsabilità: La S&P non si assume nessuna responsabilità per quanto riguarda i dati tecnici e le caratteristiche riportate nei propri cataloghi, né per le variazioni che le singole case costruttrici dovessero apportare.

Sale terms

Prices: The prices are indicative and can be changed without advice.

The costs of transport, packaging and eventual charges are not included in the prices.

Delivery terms: Ex-works

Complaints: S&P is a reseller so is not responsible for material defects. Every complaint has to be sent to S&P by fax or letter within 8 days on receipt of the goods.

Responsability: The S&P is not responsible for technic data or manufacture changes indicate in the catalogue.

Conditions générales de vente

Prix: Les prix sont indicatifs et peuvent être sujets à modifications sans avis. Ils ne comprennent costs de transport, emballage et charges eventuelles.

Délais de livraison: Ex-works.

Réclamations: La S&P est revendeur de matériel de tiers donc ne peut pas être responsable de eventuels défauts de fabrication. Les réclamations doivent être envoyées par fax ou lettre dans 8 jours de reception de la marchandise.

Responsabilité : La S&P n'est pas responsable pour les données techniques indiquées dans le catalogue ainsi que les variations faites des constructeurs.

Allgemeine Bedingungen

Preise: Die in unserer Liste angegebenen Preise können ohne Vorankündigung geändert werden. Transportkosten, Verpackung und eventuelle zusätzlichen Kosten sind in den Preisen nicht inbegriffen.

Lieferung: Ex-works.

Reklamationen: Eventuelle Reklamationen müssen schriftlich direkt an die Firma S&P innerhalb von 8 Tagen nach Warenerhalt vorgebracht werden.

Verantwortlichkeit: Die Richtigkeit der im katalog von verschiedenen Herstellern angegebenen technischen Angaben und Maße sind ohne Gewähr.

Condiciones generales

Precios: La cotizaciones espuestas en la lista se entienden indicativas y pueden ser sujetas a variaciones sin preaviso.

Los precios no comprenden gastos de transporte, embalaje y eventuales gastos accesorios.

Devolucion de la mercaderia: Ex-works.

Reclamos: La S&P actua como revendedor de materiales producidos por terceros, portanto no puede asumirse responsabilidad referida a eventuales defectos de los mismos productos. Cualquier reclamo tendrá que ser indirisado a la S&P con carta o fax entre y no depues de 8 dias del recevimiento de la mercanti

Responsabilidad: La S&P no se asume ninguna responsabilidad por quanto reguarda los datos tecnicos y las características reportadas en los propios catalogos ni por las variaciones que la singulas casas constructoras trendrian che aportar.

INDEX Cooking Catalogue 2017

Description	Cod.	Example					Page
Accenditori piezo / Piezoelectric starters	1132						138
Addolcitori / Water Softner	6101						213
Brucciatori / Burners	4111						123
Candele accensione / Candles	4102						150
Cavi / Cables	1128						166
Centraline elettroniche / P.C. Boards	1114						141
Cerniere per porta / Door hinges	8111						204
Cesti friggitrice / Fryer baskets	5107						208
Commutatori / Commutators	1115						113
Complementi tecnici / Technical complements	1143						237
Condensatori / Capacitors	1135						63
Cricchetti / Pawls	3125						207
Doccioni / Showers/cocks	6116						216
Elementi sensibili / Sensitive elements	1129						199
Elettropompe / Pumps	1103						49











INDEX Cooking Catalogue 2017

Description	Cod.	Example					Page
Elettrovalvole / Solenoid valves	1124						220
Filtri / Filters	3126						228
Gigleur iniezione gas / Gas injection gigleur	4105					167	
Giranti / Fans - Rods	3109					55	
Griglie / Grills	4137					201	
Guarnizioni O-Ring / O-Ring gaskets	2101					46	
Guarnizioni piatte / Flat gaskets	2102					47	
Guarnizioni porta frigoriferi/forni / Refrigerator/ oven door gaskets	2103					56	
Guarnizioni teflon / Teflon gaskets	2107					60	
Interruttori / Switches	1105					94	
Lame per affettatrici / Blades	7102					231	
Manometri / Manometers	1110					117	
Manopole / Knobs/Handles	3108					177	
Microinterruttori / Micro-switches	1107					119	
Molle / Springs	1117					238	

INDEX Cooking Catalogue 2017

Description	Cod.	Example					Page
Motoriduttori / Motoreducers	1134						61
Piedini / Feet	3105						279
Piloti / Pilots	4103						158
Pressostati / Pressure switches	1113						140
Pulsanti / Push buttons	1108						95
Raccorderia / Junctions- nipples	1125						282
Resistenze / Heating elements	1101						22
Relè-contattori / Relays-contactors	1109						105
Rubinetti / Cocks	4127						274
Rubinetti valvolati gas / Gas cocks	4130						173
Segnalatori luminosi / Lamps	1104						92
Spartifiamma per bruciatori / Flames spreaders	4109						122
Termocoppie / Thermocouples	4101						154
Termostati / Thermostats	1106						64
Timer-temporizzatori / Timers	1112						117

INDEX Cooking Catalogue 2017

Description	Cod.	Example					Page
Tubi di carico / Load pipes	2110						229
Tubi scarico / Drain pipes	2109						230
Valvole gas / Gas valves	4146						193
Vari cottura / Parts for cooking	4117 4217						240

Technical Notes

Filettature/edgings

1/8"	Ø 5/10 mm
1/4"	Ø 8/13 mm
3/8"	Ø 12/17 mm
1/2"	Ø 15/21 mm
3/4"	Ø 20/27 mm
1"	Ø 26/34 mm
1"1/4	Ø 33/42 mm
1"1/2	Ø 40/49 mm
2"	Ø 50/60 mm

Elettricità/electricity

Legge di Ohm / Ohm's law : $V = R \times I$

Potenza delle resistenze / heating elements power: $P = V \times I$

V = Volt

R = Ohm

I = Ampere

P = Watt

Potenze/powers

1 HP =	= 735,5 W
1 Kcal/h =	= 1,163 W

Sezione fili da rispettare in funzione della corrente utile/ Current flowing vs wires size to observe

Corrente utile/current	Sezione dei fili/wires size
$I \leq 16 A$	1,5
$16 A < I \leq 20 A$	2,5
$20 A < I \leq 32 A$	4
$32 A < I \leq 50 A$	6
$50 A < I \leq 63 A$	10

Temperature/temperatures

Fahrenheit	= $C^{\circ} (\times 9/5) + 32$
Celsius	= $(^{\circ}F - 32) \times 5/9$

Durezza H₂O/Hardness H₂O

(LT Resina/Resin \times 5000)

_____ = LT acqua addolcita/softened water \times ciclo/cycle
Durezza/Hardness H₂O ($^{\circ}F$)

SCHEDE TECNICHE / TECHNICAL SPECIFICATIONS

Per alcune categorie di prodotto sono state inserite nuove schede tecniche.
Da esse è possibile ricavare i vari ricambi correlati al codice a cui si riferiscono e anche vederli.

For some kind of products we did new technical specifications.
By looking at them it's possible to see parts or spares linked to the code they refer.

Esempio/Example: codice/code 1103001: POMPA 0,10 HP MANDATA DX/ANTICLOCKWISE PUMP 0,10 HP

Specifica tecnica/Technical information:

es/i.e: a = aspirazione pompa/pump entry =
misura/measure = 28mm

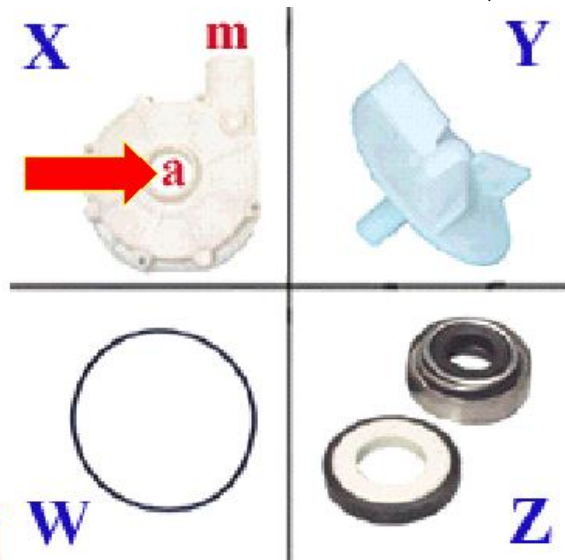

**Coordinate e codice corrispondente /
Coordinates and correspondent code:**

es/i.e: W= guarnizione pompa/pump gasket= codice S&P
S&P code 2104004



X= 1103148, a= 28mm,
m= 28mm, Y= 3109017,
W= 2104004, Z= 3110026

CONTROLLO DELLE DIMENSIONI O-RINGS

MEASUREMENT OF THE O-RINGS SIZES

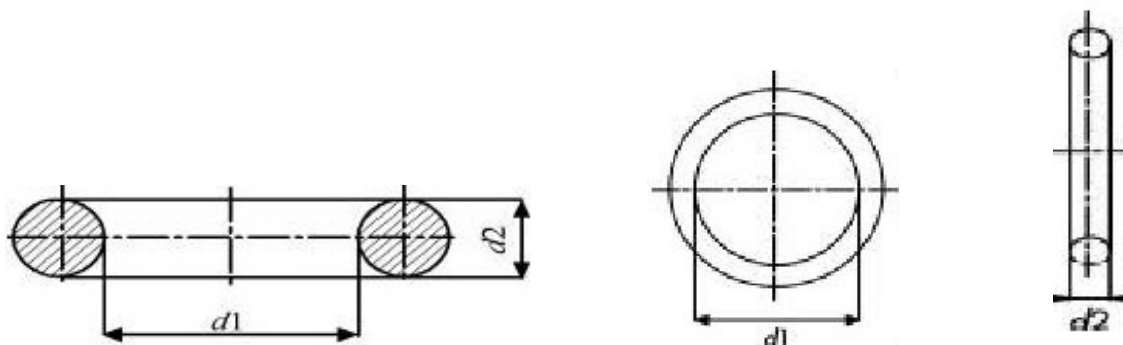

d1: diametro interno
d1: internal diameter
d1: diamètre intérieur
d1: diámetro interior

d2: spessore OR (diametro della corda)
d2: OR thickness (torus)
d2: épaisseur OR
d2: OR espesor

-Il controllo di D1 e D2 viene fatto in base alle tolleranze della tabella ISO 3601 (ex DIN 3771) parte 1.

-The measurement of D1 and D2 is carried out on the basis of the tolerances of the table ISO 3601 (ex DIN 3771) part 1.

Esempio di misurazione delle OR: codice **2101303**: (d1) 3,69 x (d2) 1,78

How to measure O-Rings: example code **2101303**: (d1) 3,69 x (d2) 1,78

d1: 3,69 diametro interno OR/ OR internal diameter

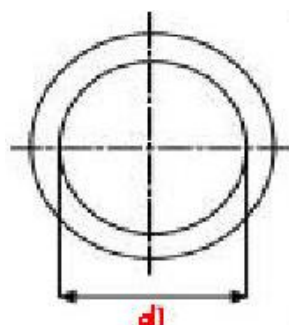

d2: 1,78 diametro della corda OR/OR thickness (torus)



S&P O-RINGS NBR

Codice/Code	Descrizione/Description d1xd2	Codice/Code	Descrizione/Description d1xd2
2101300	1,78X1,78 O-RING	2101348	95,00X1,78 O-RING
2101301	2,57X1,78 O-RING	2101349	98,05X1,78 O-RING
2101302	2,90X1,78 O-RING	2101350	101,34X1,78 O-RING
2101303	3,69X1,78 O-RING	2101351	104,40X1,78 O-RING
2101304	4,47X1,78 O-RING	2101352	107,70X1,78 O-RING
2101305	5,28X1,78 O-RING	2101353	114,00X1,78 O-RING
2101306	6,07X1,78 O-RING	2101354	117,10X1,78 O-RING
2101307	6,35X1,78 O-RING	2101355	120,40X1,78 O-RING
2101308	6,75X1,78 O-RING	2101356	133,10X1,78 O-RING
2101309	7,66X1,78 O-RING	2101357	142,11X1,78 O-RING
2101310	8,73X1,78 O-RING	2101358	161,16X1,78 O-RING
2101311	9,25X1,78 O-RING	2101359	164,34X1,78 O-RING
2101312	10,82X1,78 O-RING	2101360	2,20X1,90 O-RING
2101313	11,11X1,78 O-RING	2101361	2,40X1,90 O-RING
2101314	12,42X1,78 O-RING	2101362	2,60X1,90 O-RING
2101315	14,00X1,78 O-RING	2101363	3,40X1,90 O-RING
2101316	15,60X1,78 O-RING	2101364	4,20X1,90 O-RING
2101317	17,16X1,78 O-RING	2101365	4,90X1,90 O-RING
2101318	18,77X1,78 O-RING	2101366	5,70X1,90 O-RING
2101319	20,35X1,78 O-RING	2101367	6,40X1,90 O-RING
2101320	21,95X1,78 O-RING	2101368	7,20X1,90 O-RING
2101321	23,52X1,78 O-RING	2101369	8,00X1,90 O-RING
2101322	25,12X1,78 O-RING	2101370	8,90X1,90 O-RING
2101323	26,70X1,78 O-RING	2101796	5,60X2,40 O-RING
2101324	28,30X1,78 O-RING	2101798	7,60X2,40 O-RING
2101325	29,87X1,78 O-RING	2101797	9,60X2,40 O-RING
2101326	31,47X1,78 O-RING	2101371	2,84X2,62 O-RING
2101327	33,05X1,78 O-RING	2101372	3,63X2,62 O-RING
2101328	34,65X1,78 O-RING	2101373	4,42X2,62 O-RING
2101329	36,27X1,78 O-RING	2101374	5,23X2,62 O-RING
2101330	37,82X1,78 O-RING	2101375	6,02X2,62 O-RING
2101331	39,45X1,78 O-RING	2101376	7,60X2,62 O-RING
2101332	41,00X1,78 O-RING	2101377	9,13X2,62 O-RING
2101333	44,17X1,78 O-RING	2101378	9,19X2,62 O-RING
2101334	47,37X1,78 O-RING	2101379	9,92X2,62 O-RING
2101335	50,52X1,78 O-RING	2101380	10,78X2,62 O-RING
2101336	53,67X1,78 O-RING	2101381	11,91X2,62 O-RING
2101337	56,87X1,78 O-RING	2101382	12,37X2,62 O-RING
2101338	60,04X1,78 O-RING	2101383	13,10X2,62 O-RING
2101339	63,22X1,78 O-RING	2101384	13,95X2,62 O-RING
2101340	66,40X1,78 O-RING	2101385	15,08X2,62 O-RING
2101341	69,57X1,78 O-RING	2101386	15,54X2,62 O-RING
2101342	72,76X1,78 O-RING	2101387	15,88X2,62 O-RING
2101343	75,94X1,78 O-RING	2101388	17,13X2,62 O-RING
2101344	79,00X1,78 O-RING	2101389	17,86X2,62 O-RING
2101345	82,28X1,78 O-RING	2101390	18,72X2,62 O-RING
2101346	88,64X1,78 O-RING	2101391	20,29X2,62 O-RING
2101347	91,70X1,78 O-RING	2101392	20,64X2,62 O-RING

S&P O-RINGS NBR

Codice/Code	Descrizione/Description d1xd2	Codice/Code	Descrizione/Description d1xd2
2101393	21,90X2,62 O-RING	2101439	145,73X2,62 O-RING
2101394	22,23X2,62 O-RING	2101440	152,07X2,62 O-RING
2101395	23,47X2,62 O-RING	2101441	158,43X2,62 O-RING
2101396	23,81X2,62 O-RING	2101442	164,78X2,62 O-RING
2101397	25,07X2,62 O-RING	2101443	171,13X2,62 O-RING
2101398	26,65X2,62 O-RING	2101444	177,48X2,62 O-RING
2101399	28,25X2,62 O-RING	2101445	183,83X2,62 O-RING
2101400	29,83X2,62 O-RING	2101446	196,53X2,62 O-RING
2101401	31,42X2,62 O-RING	2101447	202,88X2,62 O-RING
2101402	33,00X2,62 O-RING	2101448	209,23X2,62 O-RING
2101403	34,60X2,62 O-RING	2101449	221,93X2,62 O-RING
2101404	36,17X2,62 O-RING	2101450	228,28X2,62 O-RING
2101405	37,77X2,62 O-RING	2101451	234,63X2,62 O-RING
2101406	39,35X2,62 O-RING	2101452	240,98X2,62 O-RING
2101407	40,95X2,62 O-RING	2101453	8,90X2,70 O-RING
2101408	42,52X2,62 O-RING	2101454	10,50X2,70 O-RING
2101409	44,12X2,62 O-RING	2101455	12,10X2,70 O-RING
2101410	45,70X2,62 O-RING	2101456	13,60X2,70 O-RING
2101411	47,30X2,62 O-RING	2101457	15,10X2,70 O-RING
2101412	48,90X2,62 O-RING	2101458	16,90X2,70 O-RING
2101413	50,47X2,62 O-RING	2101459	18,40X2,70 O-RING
2101414	52,07X2,62 O-RING	2101460	4,34X3,53 O-RING
2101415	53,65X2,62 O-RING	2101461	7,52X3,53 O-RING
2101416	55,25X2,62 O-RING	2101462	9,12X3,53 O-RING
2101417	56,82X2,62 O-RING	2101463	15,47X3,53 O-RING
2101418	58,42X2,62 O-RING	2101464	18,64X3,53 O-RING
2101419	60,00X2,62 O-RING	2101465	20,22X3,53 O-RING
2101420	61,60X2,62 O-RING	2101466	21,82X3,53 O-RING
2101421	63,17X2,62 O-RING	2101467	23,40X3,53 O-RING
2101422	64,77X2,62 O-RING	2101468	25,00X3,53 O-RING
2101423	66,35X2,62 O-RING	2101469	25,80X3,53 O-RING
2101424	67,95X2,62 O-RING	2101470	26,57X3,53 O-RING
2101425	69,52X2,62 O-RING	2101471	28,17X3,53 O-RING
2101426	71,12X2,62 O-RING	2101472	29,75X3,53 O-RING
2101427	72,70X2,62 O-RING	2101473	31,34X3,53 O-RING
2101428	75,88X2,62 O-RING	2101474	32,93X3,53 O-RING
2101429	80,60X2,62 O-RING	2101475	34,52X3,53 O-RING
2101430	82,22X2,62 O-RING	2101476	36,10X3,53 O-RING
2101431	88,58X2,62 O-RING	2101477	37,70X3,53 O-RING
2101432	94,93X2,62 O-RING	2101478	39,70X3,53 O-RING
2101433	101,28X2,62 O-RING	2101479	40,87X3,53 O-RING
2101434	113,98X2,62 O-RING	2101480	41,28X3,53 O-RING
2101435	120,33X2,62 O-RING	2101481	42,86X3,53 O-RING
2101436	126,67X2,62 O-RING	2101482	44,05X3,53 O-RING
2101437	133,00X2,62 O-RING	2101483	44,45X3,53 O-RING
2101438	139,38X2,62 O-RING	2101484	46,04X3,53 O-RING

S&P O-RINGS NBR

Codice/Code	Descrizione/Description d1xd2	Codice/Code	Descrizione/Description d1xd2
2101485	47,23X3,53 O-RING	2101531	142,47X3,53 O-RING
2101486	47,62X3,53 O-RING	2101532	145,65X3,53 O-RING
2101487	49,20X3,53 O-RING	2101533	148,82X3,53 O-RING
2101488	50,40X3,53 O-RING	2101534	152,00X3,53 O-RING
2101489	50,80X3,53 O-RING	2101535	158,35X3,53 O-RING
2101490	52,40X3,53 O-RING	2101536	164,70X3,53 O-RING
2101491	53,57X3,53 O-RING	2101537	171,05X3,53 O-RING
2101492	53,97X3,53 O-RING	2101538	177,40X3,53 O-RING
2101493	55,56X3,53 O-RING	2101539	183,75X3,53 O-RING
2101494	56,75X3,53 O-RING	2101540	190,10X3,53 O-RING
2101495	57,15X3,53 O-RING	2101541	196,45X3,53 O-RING
2101496	58,74X3,53 O-RING	2101542	202,80X3,53 O-RING
2101497	59,92X3,53 O-RING	2101543	209,15X3,53 O-RING
2101498	60,32X3,53 O-RING	2101544	215,50X3,53 O-RING
2101499	61,90X3,53 O-RING	2101545	221,85X3,53 O-RING
2101500	63,10X3,53 O-RING	2101546	228,20X3,53 O-RING
2101501	65,10X3,53 O-RING	2101547	234,55X3,53 O-RING
2101502	66,27X3,53 O-RING	2101548	240,90X3,53 O-RING
2101503	66,67X3,53 O-RING	2101549	247,25X3,35 O-RING
2101504	68,26X3,53 O-RING	2101550	253,60X3,53 O-RING
2101505	69,85X3,53 O-RING	2101551	266,30X3,53 O-RING
2101506	71,44X3,53 O-RING	2101552	279,00X3,53 O-RING
2101507	69,44X3,53 O-RING	2101553	291,70X3,53 O-RING
2101508	72,62X3,53 O-RING	2101554	304,40X3,53 O-RING
2101509	73,02X3,53 O-RING	2101555	329,80X3,53 O-RING
2101510	74,60X3,53 O-RING	2101556	355,20X3,53 O-RING
2101511	75,80X3,53 O-RING	2101557	380,60 X3,53 O-RING
2101512	78,97X3,53 O-RING	2101558	405,26X 3,53 O-RING
2101513	82,14X3,53 O-RING	2101559	430,66X3,53 O-RING
2101514	85,32X3,53 O-RING	2101560	18,30X3,60 O-RING
2101515	88,50X3,53 O-RING	2101561	19,80X3,60 O-RING
2101516	91,67X3,53 O-RING	2101562	21,30X3,60 O-RING
2101517	94,84X3,53 O-RING	2101563	23,00X3,60 O-RING
2101518	101,2X3,53 O-RING	2101564	24,60X3,60 O-RING
2101519	104,37X3,53 O-RING	2101565	26,20X3,60 O-RING
2101520	107,54X3,53 O-RING	2101566	27,80X3,60 O-RING
2101521	110,72X3,53 O-RING	2101567	29,30X3,60 O-RING
2101522	113,90X3,53 O-RING	2101568	30,80X3,60 O-RING
2101523	117,07X3,53 O-RING	2101569	32,50X3,60 O-RING
2101524	120,24X3,53 O-RING	2101570	34,10X3,60 O-RING
2101525	123,42X3,53 O-RING	2101571	35,60X3,60 O-RING
2101526	126,60X3,53 O-RING	2101572	37,30X3,60 O-RING
2101527	129,77X3,53 O-RING	2101573	16,81X5,34 O-RING
2101528	132,94X3,53 O-RING	2101574	18,42X5,34 O-RING
2101529	136,12X3,53 O-RING	2101575	24,77X5,34 O-RING
2101530	139,30X3,53 O-RING	2101576	27,94X5,34 O-RING

S&P O-RINGS NBR

Codice/Code	Descrizione/Description d1xd2	Codice/Code	Descrizione/Description d1xd2
2101577	29,51X5,34 O-RING	2101626	142,88X5,34 O-RING
2101578	31,12X5,34 O-RING	2101627	145,42X5,34 O-RING
2101579	34,29X5,34 O-RING	2101628	146,05X5,34 O-RING
2101581	40,65X5,34 O-RING	2101629	148,60X5,34 O-RING
2101582	43,82X5,34 O-RING	2101630	149,23X5,64 O-RING
2101584	50,16X5,34 O-RING	2101631	151,77X5,34 O-RING
2101585	53,34X5,34 O-RING	2101632	158,12X5,34 O-RING
2101587	59,70X5,34 O-RING	2101633	164,47X5,34 O-RING
2101588	62,87X5,34 O-RING	2101634	170,82X5,34 O-RING
2101589	66,04X5,34 O-RING	2101635	177,17X5,34 O-RING
2101590	69,22X5,34 O-RING	2101636	183,52X5,34 O-RING
2101591	72,40X5,34 O-RING	2101637	189,87X5,34 O-RING
2101592	74,63X5,34 O-RING	2101638	196,22X5,34 O-RING
2101593	75,57X5,34 O-RING	2101639	202,57X5,34 O-RING
2101594	78,74X5,34 O-RING	2101640	208,92X5,34 O-RING
2101595	79,77X5,34 O-RING	2101641	215,27X5,34 O-RING
2101596	81,92X5,34 O-RING	2101642	221,62X5,34 O-RING
2101597	85,10X5,34 O-RING	2101643	227,97X 5,34 O-RING
2101598	88,27X5,34 O-RING	2101644	278,77X5,34 O-RING
2101599	89,69X5,34 O-RING	2101645	291,47X5,34 O-RING
2101600	91,44X5,34 O-RING	2101646	304,17X5,34 O-RING
2101601	94,62X5,34 O-RING	2101647	380,37X5,34 O-RING
2101602	97,80X5,34 O-RING	2101648	405,26X5,34 O-RING
2101603	100,00X5,34 O-RING	2101649	430,66X5,34 O-RING
2101604	100,97X5,34 O-RING	2101650	481,46X5,34 O-RING
2101605	104,14X5,34 O-RING	2101893	47,00X6,00 O-RING
2101606	107,32X5,34 O-RING	2101651	113,67X6,99 O-RING
2101607	109,54X5,43 O-RING	2101652	114,70X6,99 O-RING
2101608	110,50X5,3 4 O-RING	2101653	116,84X6,99 O-RING
2101609	113,67,5,34 O-RING	2101654	120,02X6,99 O-RING
2101610	116,84X5,34 O-RING	2101655	123,20X6,99 O-RING
2101611	117,48X5,34 O-RING	2101656	124,60X6,99 O-RING
2101612	120,02X5,34 O-RING	2101657	126,37X6,99 O-RING
2101613	120,65X5,34 O-RING	2101658	129,54X6,99 O-RING
2101614	123,20X5,34 O-RING	2101659	132,72X6,99 O-RING
2101615	123,83X5,34 O-RING	2101660	134,50X6,99 O-RING
2101616	126,37X5,34 O-RING	2101661	135,90X6,99 O-RING
2101617	127,00X5,34 O-RING	2101662	139,07X6,99 O-RING
2101618	129,54X5,34 O-RING	2101663	142,24X6,99 O-RING
2101619	130,18X5,34 O-RING	2101664	145,42X6,99 O-RING
2101620	132,72X5,34 O-RING	2101665	148,60,X6,99 O-RING
2101621	133,35X5,34 O-RING	2101666	151,77X6,99 O-RING
2101622	135,90X5,34 O-RING	2101667	155,60X6,99 O-RING
2101623	136,53X5,34 O-RING	2101668	158,12X6,99 O-RING
2101624	139,70X5,34 O-RING	2101669	159,50X6,99 O-RING
2101625	142,24X5,34 O-RING	2101670	161,90X6,99 O-RING

S&P O-RINGS NBR

Codice/Code	Descrizione/Description d1xd2	Codice/Code	Descrizione/Description d1xd2
2101671	164,47X6,99 O-RING	2101717	98,02X3,53 O-RING
2101672	166,70X6,99 O-RING	2101118	37X1,5 O-RING
2101673	168,30X6,99 O-RING	2101119	58X1,5 O-RING
2101674	170,82X6,99 O-RING	2101132	2X9,5X13,5 O-RING
2101675	174,60X6,99 O-RING	2101137	1X7X9 O-RING
2101676	177,17X6,99 O-RING	2101151	6X3X12 O-RING
2101677	181,00X6,99 O-RING	2101152	81X87X3 O-RING
2101678	183,52X6,99 O-RING	2101153	43X49X3 O-RING
2101679	187,30X6,99 O-RING	2101156	70X94X2 O-RING
2101680	189,87X6,99 O-RING	2101187	13X2X17 O-RING
2101681	193,70X6,99 O-RING	2101231	28X2,5 O-RING
2101682	196,22X6,99 O-RING	2101031	37X5,33 O-RING
2101683	200,00X6,99 O-RING	2101032	46,99X5,33 O-RING
2101684	202,57X6,99 O-RING	2101033	56,52X5,33 O-RING
2101685	208,92X6,99 O-RING		
2101686	215,27X6,99 O-RING		
2101687	221,62X6,99 O-RING		
2101688	227,97X6,99 O-RING		
2101689	234,32X6,99 O-RING		
2101690	240,67X6,99 O-RING		
2101691	247,00X6,99 O-RING		
2101692	253,57X6,99 O-RING		
2101693	259,70X6,99 O-RING		
2101694	266,07X6,99 O-RING		
2101695	272,40X6,99 O-RING		
2101696	278,77X6,99 O-RING		
2101697	285,10X6,99 O-RING		
2101698	291,47X6,99 O-RING		
2101699	304,17X6,99 O-RING		
2101700	316,87X6,99 O-RING		
2101701	329,57X6,99 O-RING		
2101702	342,27X6,99 O-RING		
2101703	354,97X6,99 O-RING		
2101704	367,67X6,99 O-RING		
2101705	380,37X6,99 O-RING		
2101706	393,07X6,99 O-RING		
2101707	405,26X6,99 O-RING		
2101708	417,96X6,99 O-RING		
2101709	430,66X6,99 O-RING		
2101710	443,36X6,99 O-RING		
2101711	456,06X6,99 O-RING		
2101712	468,76X6,99 O-RING		
2101713	481,46X6,99 O-RING		
2101714	494,16X6,99 O-RING		
2101715	506,86X6,99 O-RING		
2101716	63,50X3,53 O-RING		



**NIPPLES DOPPIO MM
MALE-MALE NIPPLES**

CODICE-CODE	MISURA-SIZE
1125008	3/8
1125019	1/8
1125091	1/4
1125092	1/2
1125093	3/4

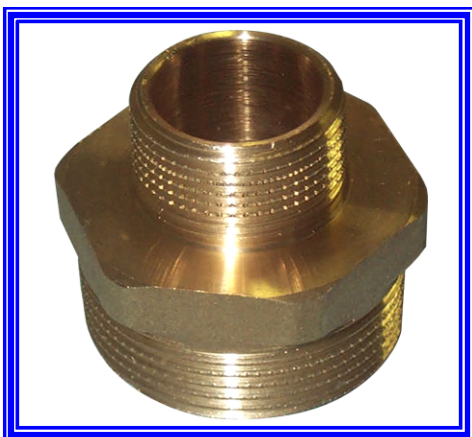

**NIPPLES RIDOTTO MM
MALE-MALE REDUCED NIPPLE**

CODICE-CODE	MISURA-SIZE
1125014	1/4 - 3/8
1125015	1/8 - 1/4
1125017	3/8 - 1/2
1125044	1/2 - 1/4
1125045	3/8 - 3/4
1125046	1/2 - 3/4
1125047	1" - 1/2
1125048	1/2 - 1"1/4
1125049	3/4 - 1"
1125050	3/4 - 1"1/4
1125051	1" - 1"1/4
1125052	1" - 1"1/2
1125053	1" - 2"
1125054	1"1/4 - 1"1/2



**RIDUZIONE ESAGONALE
HEXAGONAL REDUCTION**

CODICE-CODE	MISURA-SIZE
1125020	3/4 - 3/8
1125043	1" - 1"1/4
1125055	1/8 - 1/4
1125056	1/8 - 3/8
1125057	1/4 - 3/8
1125058	1/4 - 1/2
1125059	3/8 - 1/2
1125060	1/2 - 3/4
1125061	1/2 - 1"
1125062	1/2 - 1"1/4
1125063	1/2 - 1"1/2
1125064	1/2 - 2"
1125065	3/4 - 1"
1125066	3/4 - 1"1/4
1125067	3/4 - 1"1/2
1125068	3/4 - 2"
1125069	1" - 1"1/2
1125070	1" - 2"



**RIDUZIONE ESAGONALE F-M
F-M HEXAGONAL REDUCTION**

CODICE-CODE	MISURA-SIZE
1125108	1/4 - 1/8
1125109	3/8 - 1/4
1125110	3/8 - 1/2
1125112	1/2 - 3/8
1125113	1/2 - 1/2
1125114	3/4 - 1/2
1125126	3/4 - 3/8



**RIDUZIONE ESAGONALE F-F
F-F HEXAGONAL REDUCTION**

CODICE-CODE	MISURA-SIZE
1125097	3/8 - 1/2
1125111	3/8 - 3/8



**GOMITO F-F
ELBOW JUNCTION F-F**

CODICE-CODE	MISURA-SIZE
1125117	1/2 - 1/2
1125118	3/4 - 3/4



**RACCORDO TRE VIE OTTONE TEE F-F-F
T HOLDER JUNCTION F-F-F**

CODICE-CODE	MISURA-SIZE
1125025	3/8 - 3/8 - 3/8
1125119	1/2 - 1/2 - 1/2
1125120	3/4 - 3/4 - 3/4

SERRAFIETTI PER RACCORDERIA



1143021 Serrafiletto omologato come sigillante per gas e acqua potabile, smontabile e resistente ad urti e vibrazioni.

Caratteristiche tecniche:

Diametro: M24

Gioco max : mm 0,20

Temperatura di impiego: -55 + 150

1143021 Medium strength anaerobic adhesive for thread locking of nuts and bolts of all types that require to be dismantled. Suitable to be used on oily surfaces.

Highly resistant to heat, corrosion, vibrations, water, gas, oils, hydrocarbons and many chemicals.

Technical specifications:

Diameter: M24

Temperature range : -55 + 150

1143013 Loctite 55 è un sottile nastro bianco multifilo, senza trama, di circa 1mm di larghezza per 0.25mm di spessore in grado di sigillare istantaneamente raccordi filettati (fino a 6" di diametro), in plastica e metallo. Sostituisce canapa e nastri in PTFE.

Caratteristiche tecniche:

Sigillatura di componenti filettati, come giunzioni e raccordi per tubi; sigilla fluidi e non fuma alla temperatura di 150 C. È particolarmente adatto in caso di utilizzo immediato dell'impianto e dove vi sia la necessità di un riposizionamento prima dell'uso.

1143013 Loctite 55 is a general purpose threaded pipe and fitting sealant. A non-curing coated multifilament cord that seals out air and other common gases and fluids.

Recommended for sealing metal and plastic tapered pipe fittings up to 4" NPT for use in industrial

applications in aqueous and non-aqueous fluids. Particularly suitable in threaded assembly applications that require immediate use and may undergo small readjustments before use. This product is typically used in applications up to 149 C.



THREADSEALING-THREADLOCKING



**GHIERA DI RIDUZIONE
REDUCTION METAL RING**

CODICE-CODE	MISURA-SIZE
1125074	3/8 - 1/2
1125075	1/2 - 3/4



**MANICOTTO FF
FEMALE-FEMALE JOINT**

CODICE-CODE	MISURA-SIZE
1125094	1/4
1125095	3/8
1125096	1/2



**TAPPO M
MALE CAP**

CODICE-CODE	MISURA-SIZE
1125098	1/8
1125099	1/4
1125100	3/8
1125101	1/2



**TAPPO F
FEMALE CAP**











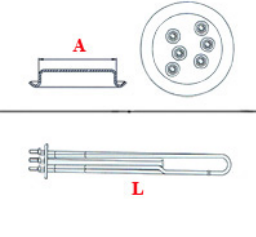

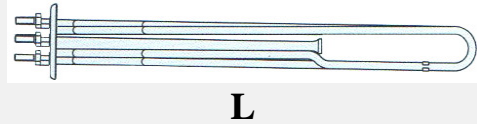
CODICE-CODE	MISURA-SIZE
1125102	1/4
1125103	3/8
1125104	1/2

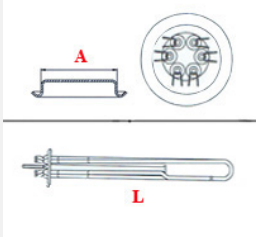

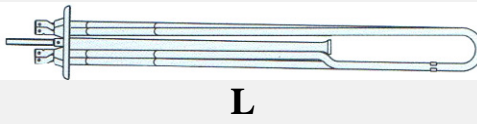
**RACCORDO TRE VIE OTTONE TEE M-M-M
T HOLDER JUNCTION M-M-M**

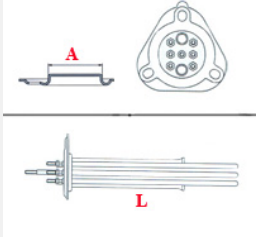









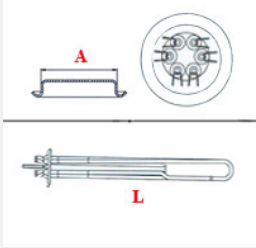



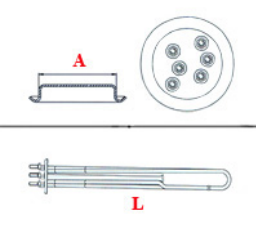

CODICE-CODE	MISURA-SIZE
1125140	1/4 - 1/4 - 1/4
1125141	3/8 - 3/8 - 3/8
1125142	1/2 - 1/2 - 1/2
1125143	3/4 - 3/4 - 3/4

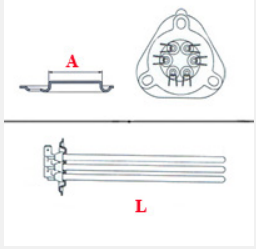
S&P Cooking Catalogue 2017



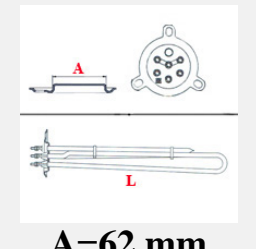



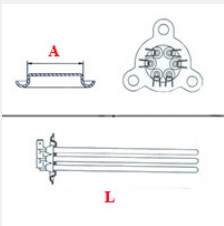

Flangia / Flange Potenza / Watts	Codice / Code	Lunghezza / Length	Guarnizione Gasket
 A=47 mm		 L	
3000 W	1101292	L=270 mm	2101032
4500 W	1101013	L=390 mm	2101032
6000 W	1101362	L=365 mm	2101032
6000 W	1101541	L=355 mm	2101032
6000 W	1101063	L=475 mm	2101032
 A=47 mm		 L	
4500-4900 W	1101491	L=370 mm	2101032
5000 W	1101215	L=250 mm	2101032
6000 W	1101506	L=290 mm	2101032
 A=47 mm		 L	
3000 W	1101524	L=260 mm	2101032
4500 W	1101372	L=340 mm	2101032
4500 W	1101539	L=370 mm	2101032
5000 W	1101218	L=260 mm	2101032
6000 W	1101352	L=370 mm	2101032
7600 W	1101898	L=330 mm	2101032
8000 W	1101301	L=360 mm	2101032
9000 W	1101913	L=360 mm	2101032
9500 W	1101465	L=330 mm	2101032
10200 W	1101867	L=400 mm	2101032

Flangia / Flange Potenza / Watts	Codice / Code	Lunghezza / Length	Guarnizione Gasket
 A=47 mm		 L	
3000 W	1101236	L=165 mm	2101032
4500 W	1101423	L=225 mm	2101032
4500 W	1101771	L=260 mm	2101032
6000 W	1101917	L=330mm	2101032
10500 W	1101415	L= 380 mm	2101032
 A=57 mm		 L	
3000 W	1101893	L=350 mm	2101033
3500 W	1101089	L=350 mm	2101033
4500 W	1101106	L=380 mm	2101033
5000 W	1101509	L=345 mm	2101033
9000 W	1101545	L=450 mm	2101033
9000 W	1101787	L=330 mm	2101033
10500 W	1101481	L=350 mm	2101033
 A=57 mm		 L	
3000 W	1101159	L=350 mm	2101033
4000 W	1101823	L=300 mm	2101033
4200 W	1101158	L=350 mm	2101033
6000 W	1101157	L=250 mm	2101033
6000 W	1101620	L=350mm	2101033
6000 W	1101261	L=485mm	2101033
7500 W	1101828	L=410 mm	2101033
8000 W	1101522	L=470 mm	2101033
9000 W	1101827	L=390 mm	2101033
10000 W	1101286	L=480 mm	2101033
12000 W	1101791	L=490 mm	2101033

S&P Cooking Catalogue 2017

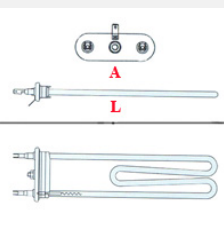
Flangia / Flange Potenza / Watts	Codice / Code	Lunghezza / Length	Guarnizione Gasket
 A=57 mm		 L	
6000 W	1101410	L=460 mm	2101033
 A=57 mm		 L	
9000/9800 W	1101531	L=460 mm	2101033
12000/13070W	1101223	L=470 mm	2101033
14000-15240 W	1101514	L=470 mm	2101033
 A=57 mm		 L	
 A=62 mm		 L	
14000 W	1101673	L=480 mm	2101058

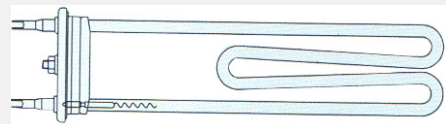
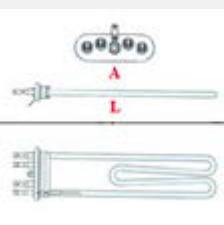
S&P Cooking Catalogue 2017

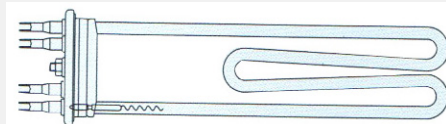
Flangia / Flange Potenza / Watts	Codice / Code	Lunghezza / Length	Guarnizione Gasket
 A=62 mm		 L	
4500 W	1101230	L=270 mm	2101058
6000 W	1101280	L=350 mm	2101058
9000 W	1101926	L=447 mm	2101058
		 L	A
1800 W	1101244	L=182 mm	56 mm
1800 W	1101852	L=495 mm	50mm
2000 W	1101162	L=290 mm	56 mm
3000 W	1101644	L=315 mm	68 mm
3000 W	1101766	L=345 mm	60 mm
3500 W	1101380	L=315 mm	68 mm
1950 W	1101802	L=230 mm	70 mm
2600 W	1101131	L=266 mm	70 mm
2750 W	1101348	L=340 mm	70 mm
2600 W	1101284	L=266 mm	80 mm
		 L	A
3000 W	1101757	L=400 mm	80 mm
4000 W	1101570	L=355 mm	70 mm
4000 W	1101815	L=340 mm	70 mm
6000 W	1101845	L=410 mm	80 mm
7600 W	1101294	L=390 mm	80 mm

S&P Cooking Catalogue 2017

1101254 RESISTEN
ZA 7000W/230V A.PO /
HEATING ELEMENT
A.PO 7000W/230V
32G1160:
ANGELO PO
GRANDI CUCINE
SPA

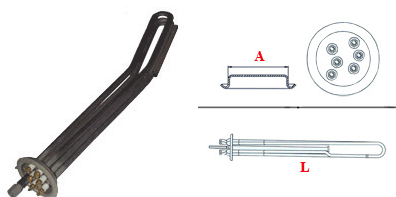

1101584 RESIST.TR
IFASI 2500W 220-380V
/
HEATING ELEMENT
2500W 220-380V

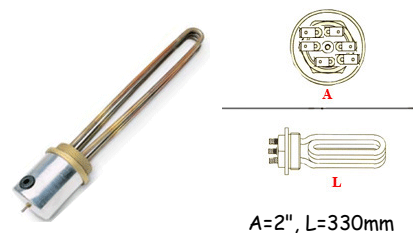

A=2", L=330mm

1101255 RESISTEN
ZA 7000W/400V A.PO /
HEATING ELEMENT
A.PO 7000W/400V
32G2330:
ANGELO PO
GRANDI CUCINE
SPA

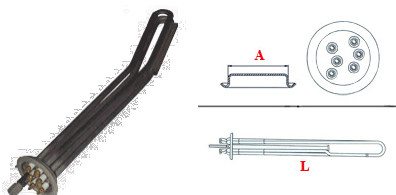

1101603 RESIST. X
BOILER RICURVA
ATT. /
BOILER HEATING
ELEMENT

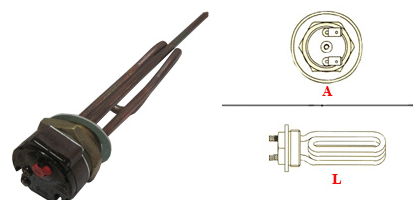

1101150 RESISTEN
ZA 7000W 230V A.PO
32G1031 /
HEATING ELEMENT
700W 230V A.PO
32G1031
32G1031:
ANGELO PO
GRANDI CUCINE
SPA

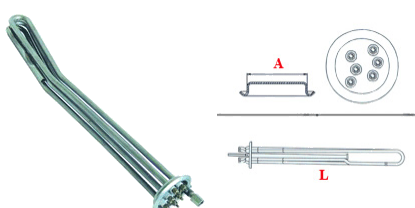

1101834 RESISTEN
ZA CUOCIPASTA
3,8KW 230V /
HEATING
ELEMENT PASTA
COOKER 3.8 KW 230V
66507415:
MODULAR SPA

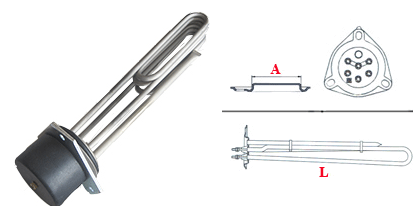

1101667 RESISTEN
ZA W.9000 V230
TLV/75E /
HEATING ELEMENT
W.9000 V230 TLV/75E
EE26100:
OEM ALI SPA

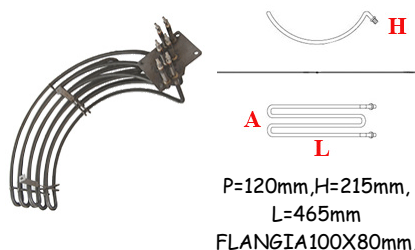

1101838 RESISTEN
ZA LATERALE 2500W
230V /
LATERAL HEATING
ELEMENT 2500W
230V
R210050: ILSA SPA

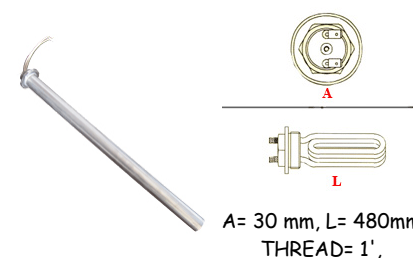

A= 30 mm, L= 480mm
THREAD= 1",

1101567 RESISTEN
ZA LIVELLO ACQUA
PENTOLA /
HEATING ELEMENT
BOILING POT
*: MARENO
INDUSTRIE ALI
SPA
CR0682160R:
MARENO
INDUSTRIE ALI
SPA
CR0682160R:
SILKO ALI SPA

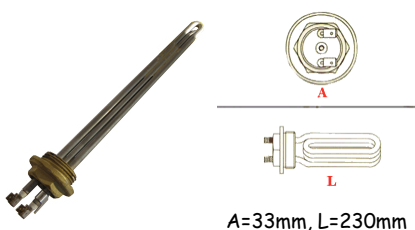

A=33mm, L=230mm

1101835 RESIST.LA
TERALE 1800W 230V /
HEATING ELEMENT
1800W 230V
R241050: ILSA SPA

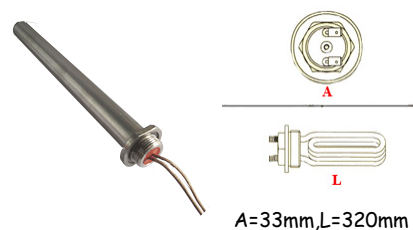

A=33mm, L=320mm

1101713 RESISTEN
ZA 2500 W 230 V 1" /
HEATING ELEMENT
2500 W 230 V 1"

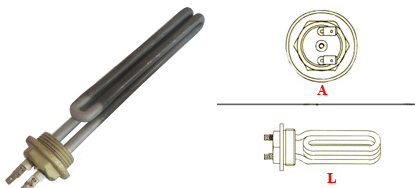

1101598 RESISTEN
ZA CUOCIPASTA 2500
W 230V 1"1/2 /
PASTACOOKER
HEATING ELEMENT
2500 W 230V 1"1/2
898986:
OFFCAR THE GREAT
COOKING S.R.L.
R210060ex:
ILSA SPA
R210061: ILSA SPA

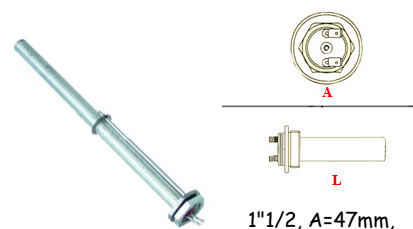

1"1/2, A=47mm,
L=490mm

S&P Cooking Catalogue 2017

1101066 RESISTEN
ZA TOSTIERA 800W
4F /
TOASTER HEATING
ELEMENT 800W 4
HOLES

2: **MBM- EUROTEC
SRL - DIV.
COOKING SERVICE
Z100E309:
S.V. ITALIA SRL
T2: RANCILIO SPA
P2 OLD: FABA SRL**

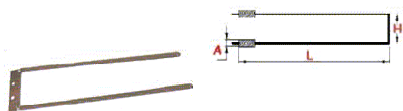

L= 290mm, H= 11mm
INSULATION=
1101088

1101026 RESISTEN
ZA TOSTIERA 1000W
4 FORI /
TOASTER HEATING
ELEMENT 1000W 4
HOLES

30014100:
**BERTO'S SPA
1: MBM- EUROTEC
SRL - DIV.
COOKING SERVICE
923003:
ELETTROBAR
DIVISIONE DELLA
EUROTEC SRL
T6, T3:
RANCILIO SPA
1: S.V. ITALIA SRL
S.V. ITALIA SRL
DIHR-ALI SPA
P3 OLD, P6 OLD:
FABA SRL
DW8070:
DIHR-ALI SPA**

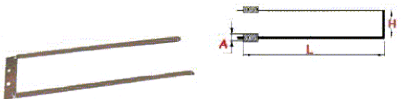

L=420mm, H=110mm
ISULATION=
1101088,

1101535 RESISTEN
ZA IN COPPIA
FORNO/3-6P /
OVEN HEATING
ELEMENT 3-6P

603:
**ARISTARCO
KASTEL SPA**



WIDTH= 120 mm,
LENGTH= 245 mm

1101554 RESISTEN
ZE QUARZO TN 2
(400W 115V
SINGOLA) /
QUARZ HEATING
ELEMENT TN2 (400W
115V)

TN2: **FABA SRL**



L=260mm

1101534 ASS.
RESISTENZA
QUARZO 110V X
390W FORNO AUT.
2P-4P L=265MM tubo /
HEATING ELEMENT
110V X 390W

6988:
**ARISTARCO
KASTEL SPA**



L=285mm

1101310 RESISTEN
ZA QUARZO115/500W
X TN3/TN6 /
HEATING ELEMENT
155/500W X TN3/TN6
PR40057: **FABA SRL**



Ø vetro=11,5mm,
Ø ceramica=16mm,
L=385mm

1101916 RESISTEN
ZA PER TOSTIERA
INFRARED
BOCC.CERAMICHE
F60-120 500W 115V /
TOASTER HEATING
ELEMENT F60-120
500W 115V

DW8156: **DIHR-ALI
SPA**



Ø vetro=10mm,
Ø ceramica=14,4mm,
L=385mm

1101386 ASS.
RESISTENZA
QUARZO 110V X
500W FORNO 3P-6P
MOD. 2003 L=400MM /
OVEN HEATING
ELEMENT 110V 500W
3P-6P MOD. 2003
L=360MM

6989:
**ARISTARCO
KASTEL SPA**



L=400mm

1101468 RESIST.
QUARZO CON
FASTON 115V 300W
NUOVO MOD. /
HEATING ELEMENT
WITH FASTON 115V
300W NEW TYPE
PR46018: **FABA SRL**



L=430mm

1101688 COPPIA
TUBI
QUARZO+RESISTENZ
E.230/1000 /
QUARZHOSE PAIR
WITH HEATING
ELEMENT 230/1000
EE01300:
OEM ALI SPA



L resistenza=400mm,
L tubo=390mm

1101536 TUBO
QUARZO 11X12X390
FORNO/3-6P /
QUARZHOSE FOR
OVEN 11X12X390 /3-
6P
615:

**ARISTARCO
KASTEL SPA**



L=390mm

1101309 TUBO
QUARZO X MAXI
GRILL /
QUARTZ PIPE FOR
MAXI GRILL
PR46017: **FABA SRL**



L=440mm

1101088 COPPIA
ISOLANTI X
TOSTIERA /
TOASTER PAIR
INSULATORS
PR405/6+PR405/7:
FABA SRL



1101250 RESISTEN
ZA FRIGGITRICE
18000 W A.PO /
FRYER HEATING
ELEMENT A.PO
1800W
32G2400:
ANGELO PO
GRANDI CUCINE
SPA



1101914 RESISTEN
ZA 7,2kW-230V /
HEATING ELEMENT
7,2kW-230V
32G2610:
ANGELO PO
GRANDI CUCINE
SPA

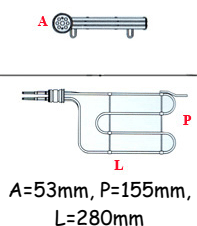

1101778 RESISTEN
ZA FRIGGITRICE
ELETTRICA 8,500W /
HEATING ELEMENT
ELECTRIC FRYER
8,500 W
K29902: A.T.A. SRL

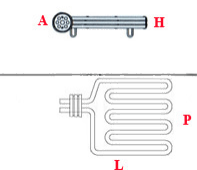

1101600 RESIST.CO
R.ROT.F18 13500W
230V3(S) /
HEATING ELEMENT
F18 13500W 230V
537021401:
LOTUS SPA

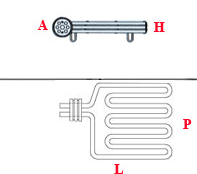

1101487 RESISTEN
ZA CUOCIPASTA
5,67KW 380V SERIE
70 /
HEATING ELEMENT
PASTA COOKER
5,67KW 380V SERIES
70
PC7-4E:
MARENO
INDUSTRIE ALI
SPA
MA1870000R:
SILKO ALI SPA

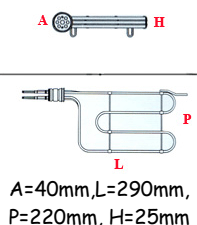

1101030 RESISTEN
ZA C.PASTA 8,5KW
230V /
PASTA COOKER
HEATING ELEMENT
8,5KW 230V
MA1869900R:
SILKO ALI SPA
MA1869900R:
MARENO
INDUSTRIE ALI
SPA

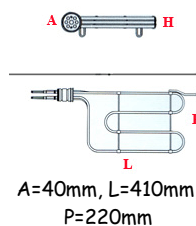

1101650 ASS.
RESISTENZA
CUOCIPASTA 900 /
PASTA COOKER
HEATING ELEMENT
CR0582040R:
MARENO
INDUSTRIE ALI
SPA
CR0582040R:
SILKO ALI SPA



1101674 ASS.RESIS
TENZA FRIGGITRICE
10L 9KW /
FRYER HEATING
ELEMENT 10L 8KW
MA1037316601R:
MARENO
INDUSTRIE ALI
SPA
MA1037316601R:
SILKO ALI SPA

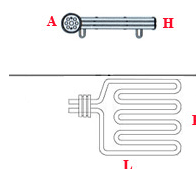

1101642 RESISTEN
ZA FRIGGITRICE
16500W 90
1GOL6P387001 /
FRYER HEATING
ELEMENT 16500W 90
1GOL6P387001
0105151:
SILKO ALI SPA
MACM032401:
MARENO
INDUSTRIE ALI
SPA
MACM032401R:
MARENO
INDUSTRIE ALI
SPA
MACM032401R:
SILKO ALI SPA

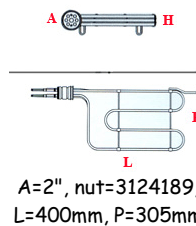

1101593 RESISTEN
ZA 1800W 230V /
HEATING ELEMENT
1800W 230V
537003501:
LOTUS SPA

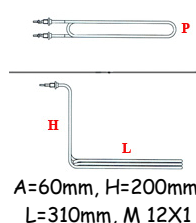
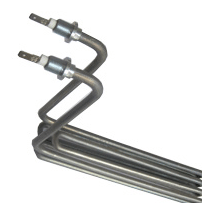

S&P Cooking Catalogue 2017

1101129 RESISTEN
ZA FRIGGITRICE
2000W 220V /
FRYER HEATING
ELEMENT 2000W
220V
00033141:
ELFRAMO SPA

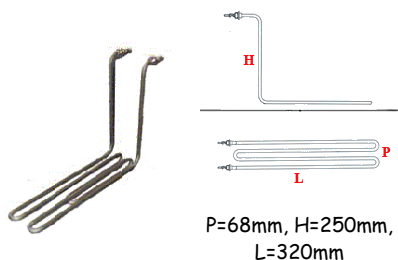

P=68mm, H=250mm,
L=320mm

1101691 RESISTEN
ZA FRIGGITRICE
ELETRICA F8B-2KW
1GOL6BN34001 /
HEATING ELEMENT
ELECTRIC FRYER
F8B-2KW
1GOL6BN34001
180588:
MBM- EUROTEC SRL
- DIV. COOKING
SERVICE

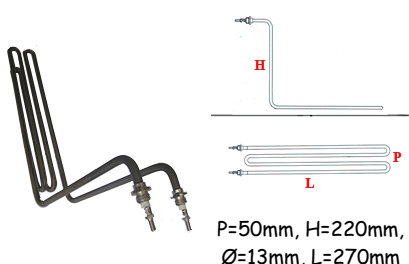

P=50mm, H=220mm,
Ø=13mm, L=270mm

1101358 RESISTEN
ZA FRIGGITRICE
2100W 230V /
FRYER HEATING
ELEMENT 2100W
230V
6002155:
GIORIK SPA

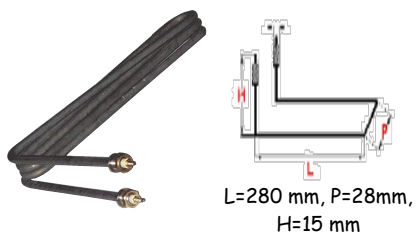

L=280 mm, P=28mm,
H=15 mm

1101579 RESISTEN
ZA FRE 2500W - 230V
/
HEATING ELEMENT
FRE2500W - 230V
66502800:
MODULAR SPA

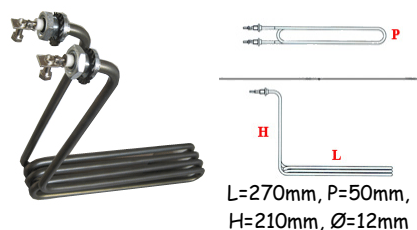

L=270mm, P=50mm,
H=210mm, Ø=12mm

1101903 RESISTEN
ZA 2500W 230V /
HEATING ELEMENT
2500W 230V
059188:
ELECTROLUX
PROFESSIONAL
S.P.A.

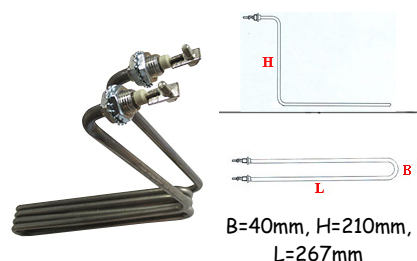

B=40mm, H=210mm,
L=267mm

1101394 RESISTEN
ZA FRIGGITRICE
3000W 220V /
HEATING ELEMENT
FRYER 3000W 220V
00033142:
ELFRAMO SPA

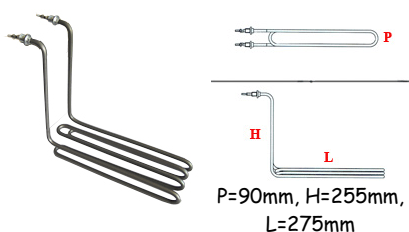

P=90mm, H=255mm,
L=275mm

1101497 R.EF60BP
3KW230 /
HEATING ELEMENT
60BP 3KW230
161879:
ELETTROBAR
DIVISIONE DELLA
EUROTEC SRL
161879:
MBM- EUROTEC SRL
- DIV. COOKING
SERVICE
180580:
MBM- EUROTEC SRL
- DIV. COOKING
SERVICE

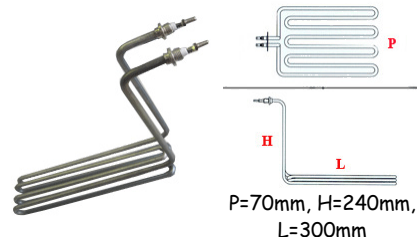

P=70mm, H=240mm,
L=300mm

1101369 RESISTEN
ZA FRIGGITRICE
3100W FRIGGI 7 /
FRYER HEATING
ELEMENT 3100W
FRIGGI7
FRIGGI7: FABBA SRL

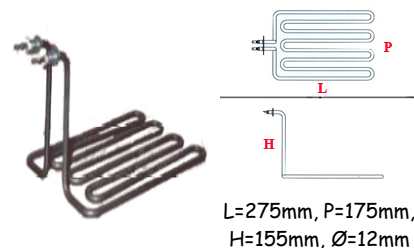

L=275mm, P=175mm,
H=155mm, Ø=12mm

1101562 RESISTEN
ZA 3300W FRIGGI 6M
- 6+6M /
HEATING ELEMENT
3300W FOR FRITEUSE
6+6M
PR70054: FABBA SRL

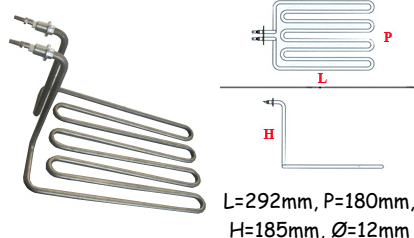

L=292mm, P=180mm,
H=185mm, Ø=12mm

1101761 ELEMENT
O RESISTENZA PER
FRIGGITRICE KW3,3
230V /
HEATING ELEMENT
ELEMENT FOR
FRYER KW3,3 230V
00033151:
ELFRAMO SPA

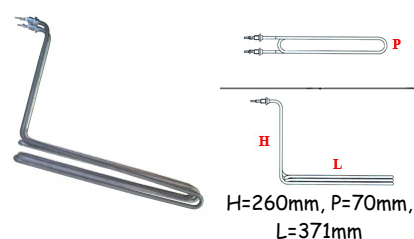

H=260mm, P=70mm,
L=371mm

1101891 RESISTEN
ZA FRIGGITRICE FRE
3400W 230V /
FRYER HEATING
ELEMENT 3400W
230V
96500900:
MODULAR SPA

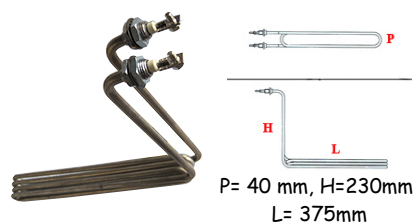

P= 40 mm, H=230mm,
L= 375mm

1101569 RESISTEN
ZA 3500W F5-6M /
HEATING ELEMENT
3500W F5-6M
PR70211: FABBA SRL

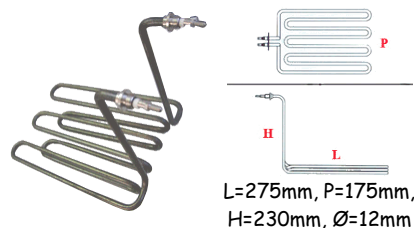

L=275mm, P=175mm,
H=230mm, Ø=12mm

1101882 RESISTEN
ZA 5000 W 220 V
FRIGGITRICE /
FRYER HEATING
ELEMENT 5000 W 220
V

MA1464000:
MARENO
INDUSTRIE ALI
SPA

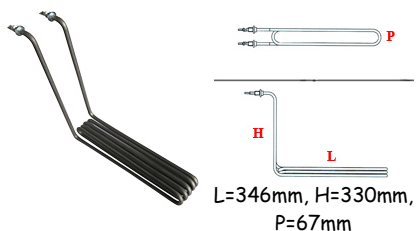

1101436 AS.RES.EF
8B-6KW 1GOL6V511 /
HEATING ELEMENT
EF8B-6KW
1GOL6V511

164716:
ELETTROBAR
DIVISIONE DELLA
EUROTEC SRL
161861:
ELETTROBAR
DIVISIONE DELLA
EUROTEC SRL
164716:
MBM- EUROTEC SRL
- DIV. COOKING
SERVICE

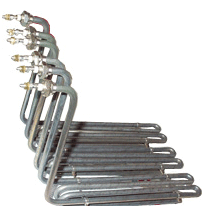

1101437 KIT
RESISTENZA DRB81
(8KW) /
HEATING ELEMENT
KIT DRB81 (8KW)

*:
MBM- EUROTEC SRL
- DIV. COOKING
SERVICE
927280:
ELETTROBAR
DIVISIONE DELLA
EUROTEC SRL
DRB81: COLGED

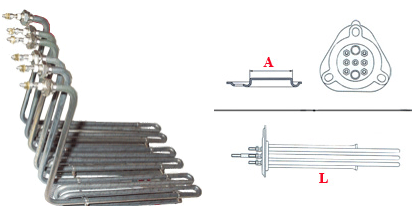

1101660 RESISTEN
ZA FRIGGITRICE
9000W BARON /
FRYER HEATING
ELEMENT 9000W
BARON

BN9000482:
POLARIS/BARON
ALI S.P.A.
BN9000482:
OLIS DIVISIONE
DI ALI GROUP SPA -

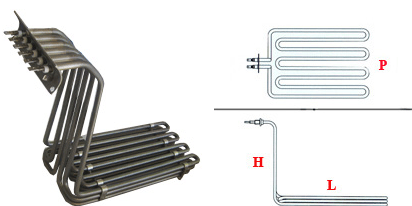

1101664 AS.RES.EF
25S-12KW
1GOL6V632001 /
HEATING ELEMENT
12KW 1GOL6V632001

*: MBM- EUROTEC
SRL - DIV.
COOKING SERVICE
164718:
MBM- EUROTEC SRL
- DIV. COOKING

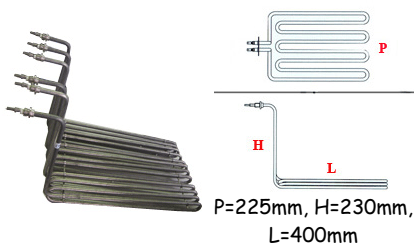

SERVICE

1101364 ASS.RESIS
TENZA FQE41/61 6KW

/
COMPLETE HEATING
ELEMENT FQE41/61
6KW

MA1037317100:
MARENO
INDUSTRIE ALI
SPA
MA1037317100:
SILKO ALI SPA

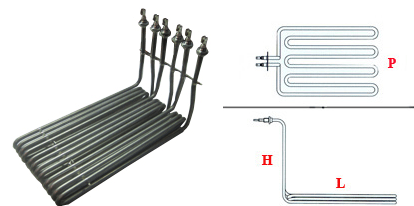

1101508 RESISTEN
ZA FRIGGITRICE
7000W BERTO'S /
FRYER HEATING
ELEMENT 7000W
BERTO'S
33026500:
BERTO'S SPA



1101485 RESIST.ZA
8250W/230V 3F ME15 /
HEATING ELEMENT
8250W/230V 3F ME15

*:
MBM- EUROTEC SRL
- DIV. COOKING
SERVICE

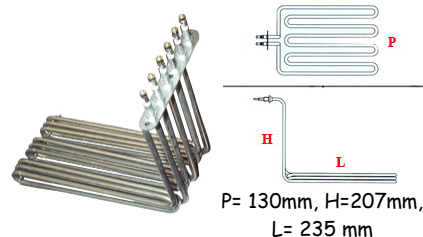

1101463 PIASTRA
EL.W 1500 D.145R V
230 /
PLATE 1500W D-145R
230V

6001065:
GIORIK SPA



1101537 PIASTRA
ELETTRICA Ø145MM
1500W 230V /
HEATING ELEMENT
GRILL Ø145MM 1500W
230V

RTC700087:
MBM- EUROTEC SRL
- DIV. COOKING
SERVICE



1101782 PIASTRA
ELETTRICA Ø 180MM
230V 1500W /
ELECTRIC HOT
PLATE Ø 180MM
1500W 230V



1101460 PIASTRA
EL.W 2000 D.180 V 230

/
GRILL 2000W D.180
230V

537019800 :

LOTUS SPA
AER002ZR10:
GIGA GRANDI
CUCINE SRL

36037500:

BERTO'S SPA

BN6A048901:

OLIS DIVISIONE
DI ALI GROUP SPA -

32G0290:

ANGELO PO

GRANDI CUCINE

SPA

6001064:

GIORIK SPA



Ø 180mm

BERTO'S SPA

1832313:

SILKO ALI SPA

X45300:

GIGA GRANDI

CUCINE SRL

0101482:

SILKO ALI SPA

MA1832313:

SILKO ALI SPA

SIRO101482:

SILKO ALI SPA

1101432 PIASTRA

ELETTRICA Ø180MM

2000W 400V /

ELECTRIC PLATE

2000W 400V Ø180mm



Ø 180mm

1101433 PIASTRA

ELETTRICA; DIA

22CM 2600W 400V /

HEATING ELEMENT

GRILL 2600W/400V

D.220mm

22037900:

BERTO'S SPA

RTC700127:

MBM- EUROTEC SRL

- DIV. COOKING

SERVICE

BN6A045600:

OLIS DIVISIONE

DI ALI GROUP SPA -

003931:

ELECTROLUX

PROFESSIONAL

S.P.A.

32G0300:

ANGELO PO

GRANDI CUCINE

SPA



Ø 220mm

1101605 PIASTRA

COTTURA Ø220MM

2000W 230V /

ELECTRIC PLATE

Ø220MM 2000W 230V



Ø 220 mm

1101542 PIANO

COTTURA D.300MM

3500W 220V /

HEATING ELEMENT

GRILL 3500W/220V

D.300mm



Ø 300mm

1101248 PIASTRA

ELETTRICA

2600W/230V D.220mm

/

HEATING ELEMENT

GRILL 2600W/230V

D.220mm

MA1832313:

MARENO

INDUSTRIE ALI

SPA

RTC700086:

MBM- EUROTEC SRL

- DIV. COOKING

SERVICE

BN6A045300:

OLIS DIVISIONE

DI ALI GROUP SPA -

843412:

OFFCAR THE

GREAT COOKING

S.R.L.

053407:

ELECTROLUX

PROFESSIONAL

S.P.A.

22037800:



Ø 220 mm

1101341 PIASTRA

240V 250W HOT DOG

/

HOT DOG GRILL

240V 250W

HOT DOG -SW1:

CB SRL



1101888 Piastra

radiante 200 mm 1700

W 230 V /

RADIATION HEATER

200mm 1700W 230V



Ø=200mm

1101774 PIASTRE
RISCALDANTI
SOTTOPIANO 1800 W
230 V CON
TERMOSTATO DI
LAVORO 128 °C E
SICUREZZA 250°C /
UNDER PLAN
HEATING PLATES
1800 W 230 V WITH
THERMOSTAT 128 °C
AND SAFETY 250 °C

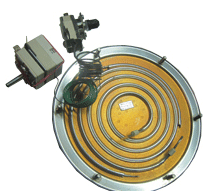

FLANGE= 4217054,
GASKET= 2102542

1101837 ELEMENT
O RADIANTE 1.8 KW
230V /
RADIANT ELEMENT
1.8 KW 230V
CR0511570:
MARENO
INDUSTRIE ALI
SPA
CR0511570:
SILKO ALI SPA

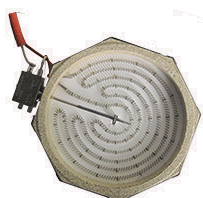

1101818 ELEMENT
O RADIANTE 3,4KW
V9 /
HEATING ELEMENT
V9 3,4KW
CR0509620:
MARENO
INDUSTRIE ALI
SPA
BN6A001405MAG:
OLIS DIVISIONE
DI ALI GROUP SPA -



1101895 PIASTRA
ELETTRICA
220x220mm 2000 W
400 V /
HOT PLATE
220x220mm 2000 W
400 V

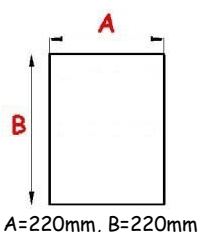

1101272 PIASTRA
ELETTRICA
220X220mm 2600W
230V /
HEATING ELEMENT
GRILL 220X220mm
X45500:
GIGA GRANDI
CUCINE SRL
0A2199:
ELECTROLUX
PROFESSIONAL
S.P.A.
006220:
ELECTROLUX
PROFESSIONAL
S.P.A.
0A2198:
ELECTROLUX
PROFESSIONAL
S.P.A.
0101475:

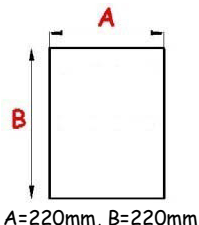
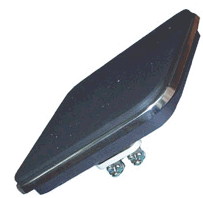

SILKO ALI SPA
SIR0101475:
SILKO ALI SPA

1101826 PIASTRA
ELETTRICA
220X220MM 2600W
230V N.E. /
ELECTRIC PLATE
2600W 230V
220X220MM N.E.
CO0637:
EMMEPI GRANDI
CUCINE S.R.L.
537017000:
LOTUS SPA

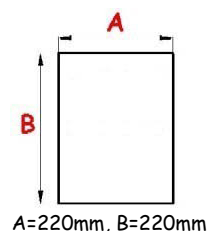

1101896 PIASTRA
ELETTRICA
220x220mm 2600 W
400 V /
HOT PLATE
220x220mm 2600 W
400 V
32G2860:
ANGELO PO
GRANDI CUCINE
SPA
BN6A036730:
OLIS DIVISIONE
DI ALI GROUP SPA
537022700:
LOTUS SPA

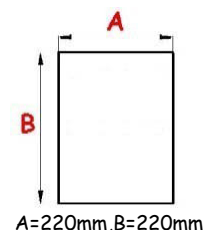

1101314 PIASTRA
ELETTRICA
300X300mm 3000W
230V /
HOT PLATE
300X300mm 3000W
230V

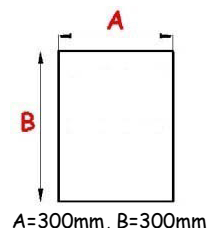

1101458 PIASTRA
EL.Q300 3000W 230V
EGO1133454247 /
HOT PLATE Q300
3000W 230V
EGO1133454247
96500300:
MODULAR SPA
RTC800115:
MBM- EUROTEC SRL
- DIV. COOKING
SERVICE
MA1937100:
MARENO
INDUSTRIE ALI
SPA
052196:
ELECTROLUX
PROFESSIONAL
S.P.A.
052198:
ELECTROLUX
PROFESSIONAL
S.P.A.

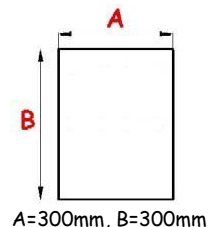

1101558 PIASTRA
COTTURA 300X300
3000W 230V N.E. /
HEATING ELEMENT
GRILL 300X300 3000W
230V

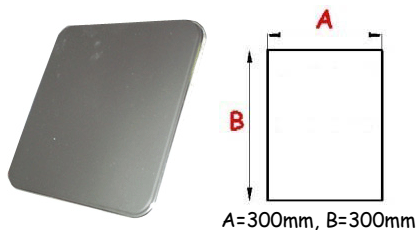

1101459 PIASTRA
EL.Q300 3000W 400V
1133454248 /
GRILL Q300 3000W
400V 1133454248
MA1937200:
MARENO
INDUSTRIE ALI
SPA

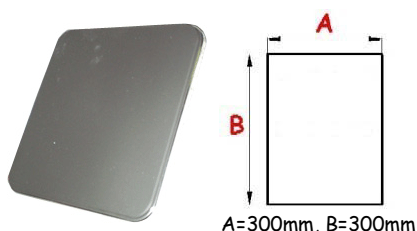

1101512 PIASTRA
ELETTRICA
300X300MM 4000W
230V /
HOT PLATE
300X300mm 4000W
230V
1937300:
MARENO
INDUSTRIE ALI
SPA

RTC800116ex:
MBM- EUROTEC
SRL - DIV.
COOKING SERVICE
96500400:
MODULAR SPA
RTC800118:
MBM- EUROTEC SRL
- DIV. COOKING
SERVICE
052199:
ELECTROLUX
PROFESSIONAL
S.P.A.
MA1937300:
MARENO
INDUSTRIE ALI
SPA
MA1937300:
SILKO ALI SPA

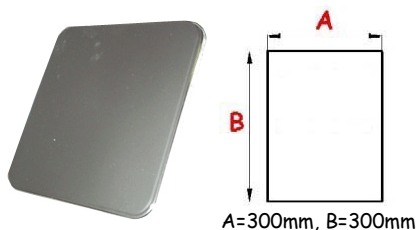

1101801 PIASTRA
ELETTRICA
300X300M 4000W
230V N.E. /
ELECTRIC PLATE
4000W 230V
300X300M N.E

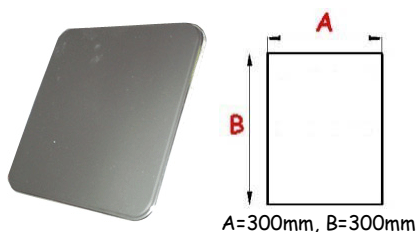

1101488 PIASTRA
ELETTRICA
300X300MM 4000W
400V /
HOT PLATE
300X300MM 4000W
400V

MA1937400:
MARENO
INDUSTRIE ALI
SPA
052200:
ELECTROLUX
PROFESSIONAL
S.P.A.
3261080:
ANGELO PO
GRANDI CUCINE
SPA
MA1937400:
SILKO ALI SPA

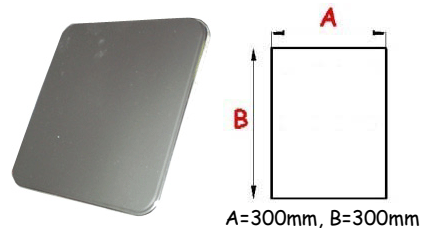

1101132 RESISTEN
ZA MICA TOSTIERA
VERTICALE 120V /
TOASTER VERTICAL
HEATING ELEMENT
1104:
ARISTARCO
KASTEL SPA

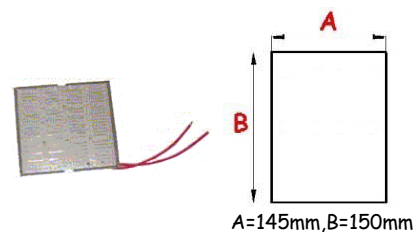

1101396 RESISTEN
ZA SINGOLA
VETROCERAMICA /
PLATE HEATING
ELEMENT
PR13009: FABA SRL

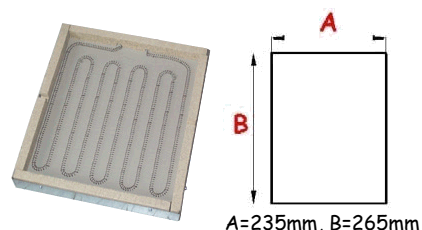

1101395 RESISTEN
ZA MEDIA
VETROCERAMICA /
PLATE HEATING
ELEMENT
PR13095: FABA SRL

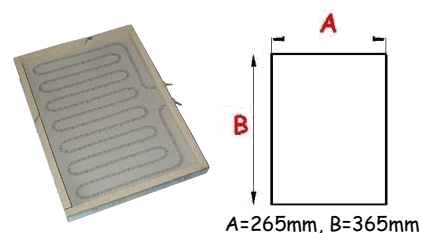

1101549 RESISTEN
ZA RADIANTE
300X300MM 4000W
380V /
HEATING ELEMENT
300X300MM 4000W
380V

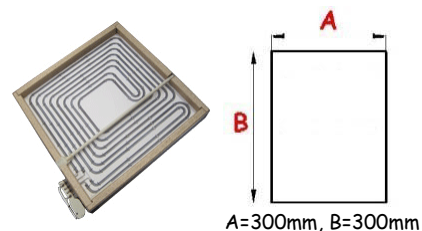

1101789 PIASTRA
ELETTRICA 4000W
400V /
ELECTRIC PLATE
4000W 400V

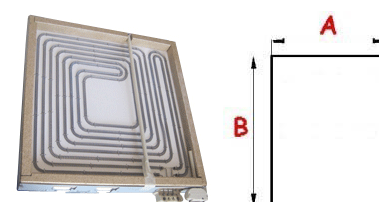

S&P Cooking Catalogue 2017

1101499 RESISTEN
ZA 5000W 230V /
HEATING ELEMENT
5000W 230V
005942:
ELECTROLUX
PROFESSIONAL
S.P.A.

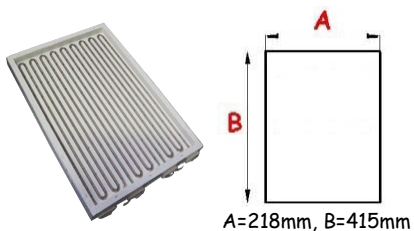

1101883 RESISTEN
ZA 230V 1100W
ORION/1.5 /
HEATING ELEMENT
230V 1100W
ORION/1.5
2396:
ARISTARCO
KASTEL SPA

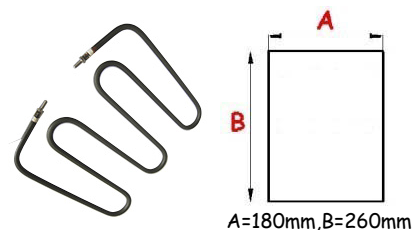

1101639 RESISTEN
ZA RETTANGOLARE
4000 W (3X1334) 230 V
/
HEATING ELEMENT
4000 W (3X1334) 230 V

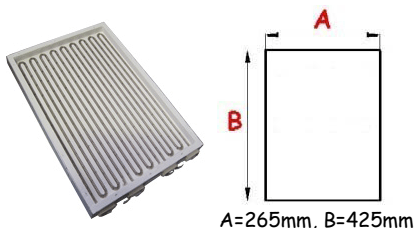

1101519 RESISTEN
ZA 230V 1200W
ORION/1.5 /
HEATING ELEMENT
230V 1200W
ORION/1.5
2397:
ARISTARCO
KASTEL SPA

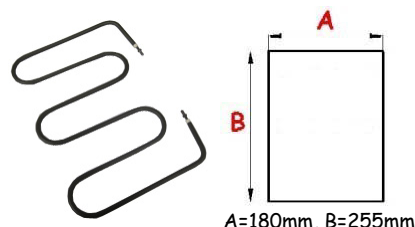

1101792 *R*
ASSIEME
RESISTENZA .
RAD.IANTE 6000W
230V C-P_/
RADIANT HEATING
ELEMENT
ASSEMBLY C-P
6000W-230V
770124250:
GICO SPA

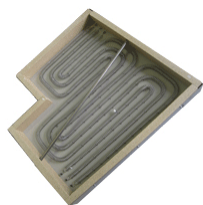

1101195 RESISTEN
ZA INF.COMP.1000W
230V 30023500 /
HEATING ELEMENT
1000W 230V 30023500
30023500:
BERTO'S SPA

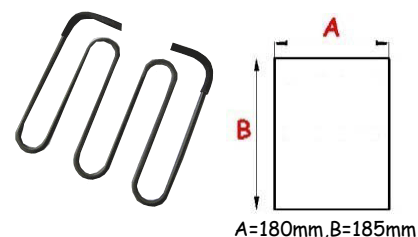

1101796 RESISTEN
ZA CPE INFRAROSSI
7,5 kW 400V** /
CPE INFRARED
HEATER 7.5kW 400V
96503700:
MODULAR SPA

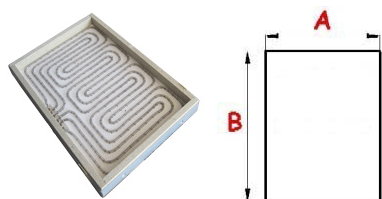

1101500 RESISTEN
ZA COMPL. 700W
230V /
HEATING ELEMENT
700W 230V
30022500:
BERTO'S SPA

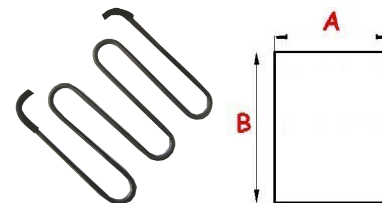

1101573 RESISTEN
ZA 230V 870W
ORION/1-2 220V 800W
/
HEATING ELEMENT
230V 870W ORION/1-2
220V 800W
1597:
ARISTARCO
KASTEL SPA

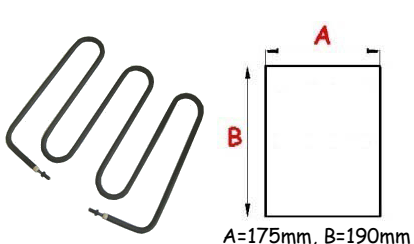

1101303 RESISTEN
ZA 1000W PIASTRA
BERTOS /
GRILL HEATING
ELEMENT 1000W
BERTO'S
30024100:
BERTO'S SPA

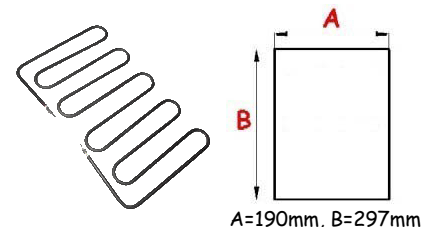

1101321 RESISTEN
ZA 220V 900W
ORION/1-2 230V 980W
/ HEATING ELEMENT
220V 900W ORION/1-2
230V 980W
1598:
ARISTARCO
KASTEL SPA

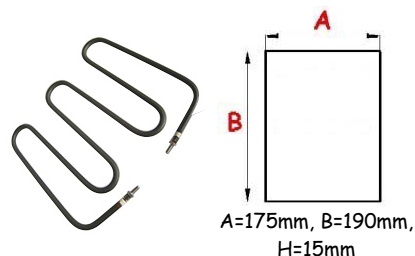

1101304 RESISTEN
ZA 1500W PIASTRA
BERTOS /
GRILL HEATING
ELEMENT 1500W
BERTO'S
30024300:
BERTO'S SPA

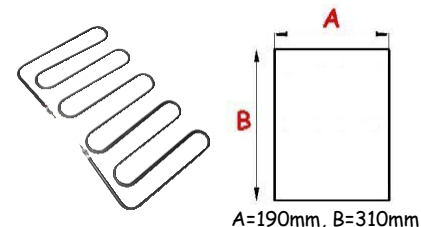

1101110 RESISTEN
ZA PIASTRA 800W
230V /
PLATE HEATING
ELEMENT 800W 230V
3: MBM- EUROTEC
69000643:
RANCILIO SPA
PR10013: FABA SRL
DW9008: DIHR

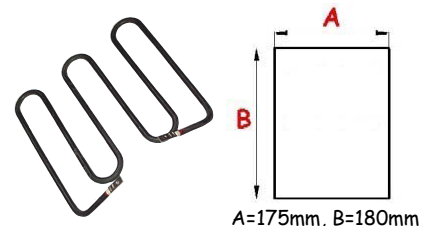

110112 RESISTEN
ZA PIASTRA 1000W
230V /
PLATE HEATING
ELEMENT 1000W
230V

5: MBM- EUROTEC
SRL - DIV.
COOKING SERVICE
69000644:
RANCILIO SPA
PR10003: FABA SRL

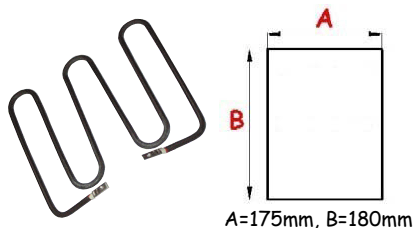

1101187 RESISTEN
ZA PIASTRA S/D
0,75KW 380V /
PLATE HEATING
ELEMENT S/D
0,75KW 380V
905660:
SILANOS SRL

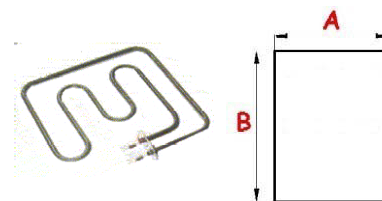

1101191 RESISTEN
ZA PIASTRA 750W
230V /
PLATE HEATING
ELEMENT 750W 230V
905650:
SILANOS SRL

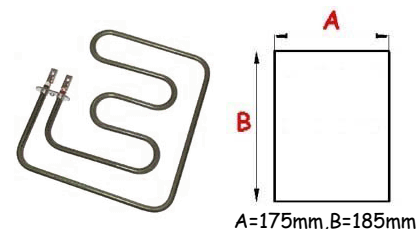

1101111 RESISTEN
ZA PIASTRA 1200W
230V /
PLATE HEATING
ELEMENT 1200W
230V

6: MBM- EUROTEC
SRL - DIV.
COOKING SERVICE
690000:
RANCILIO SPA
PR1031: FABA SRL

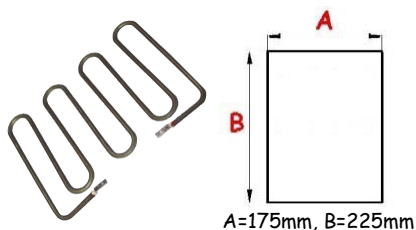

1101760 RESISTEN
ZA PIASTRA MEDIA
1,2 Kw 230V /
HEATING ELEMENT
PLATE MEDIA 1.2 Kw
230V
905615:
SILANOS SRL

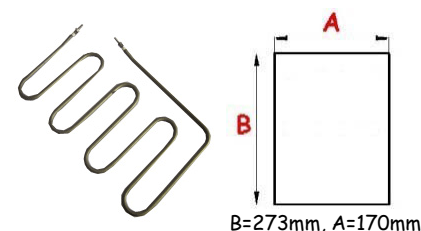

1101242 RESISTEN
ZA 1500W 230V /
HEATING ELEMENT
1500W 230V
PR1032: FABA SRL

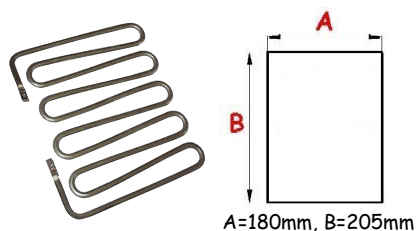

1101879 RESISTEN
ZA PIASTRA
SUPERIORE
PV2063/2064/2066
630W 230V /
SUPERIOR PLATE
HEATING ELEMENT
PV2063/2064/2066
630W 230V
XRPV2: VEMA SRL

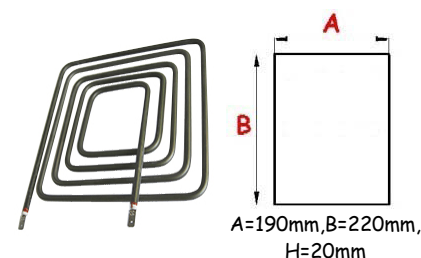

1101393 RESIST. P.
MEDIA 1,4 KW 230V /
PLATE HEATING
ELEMENT 1,4 KW
230V
905635:
SILANOS SRL

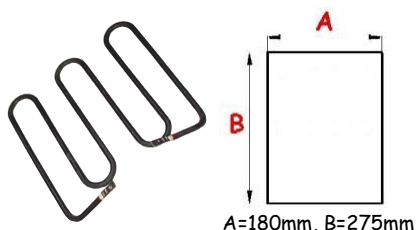

1101287 RESISTEN
ZA 1100W SUP. GRILL
ROTANTE /
HEATING ELEMENT
1100W
PR4G042: FABA SRL

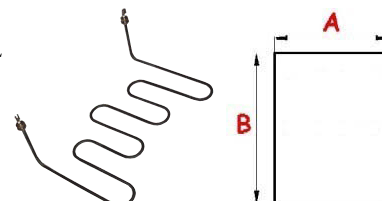

1101559 RESIST. P.
S/D 1 KW 230V+CAVI
/
HEATING ELEMENT
L/R 1 KW 230W
905671ex:
SILANOS SRL
905670:
SILANOS SRL

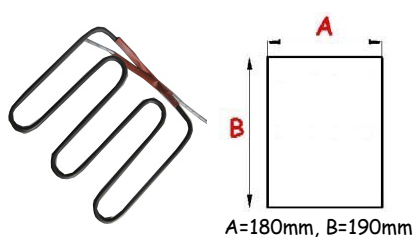

1101417 RESISTEN
ZA CENTRALE 1100W
230V /
HEATING ELEMENT
1100W 230V
PR4G041: FABA SRL

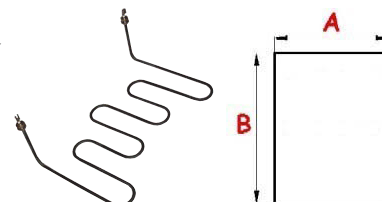

1101633 RESIST. P.
VTC 0,80 KW 230V /
HEATING ELEMENT
0,80 KW 230V
905683:
SILANOS SRL

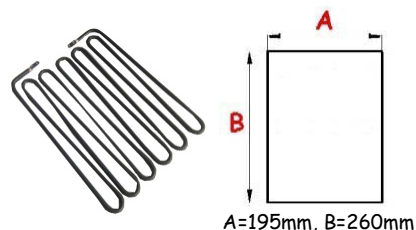

1101418 RESISTEN
ZA INFERIORE 1100W
230V /
HEATING ELEMENT
1100W 230V
PR4G040: FABA SRL

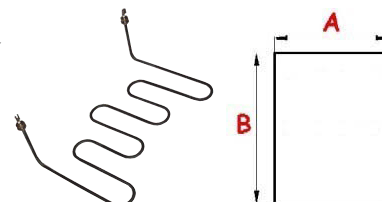

S&P Cooking Catalogue 2017

1101442 RESISTEN

ZA EC45 3KW230 /
HEATING ELEMENT
EC452 3KW230

RTBF800168:

MBM- EUROTEC SRL
- DIV. COOKING
SERVICE

RTC800342:

MBM- EUROTEC SRL



GASKET= 2101386

1101371 "RESISTEN

ZA; 2200W 230V" /
HEATING ELEMENT
2200W 230V

059401:

ELECTROLUX
PROFESSIONAL
S.P.A.

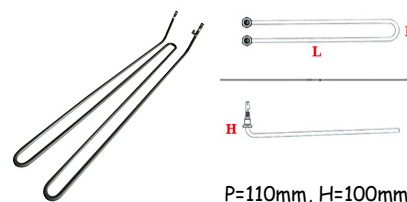

P=110mm, H=100mm,
L=565mm

1101597 R.EC77

3KW230 /
HEATING ELEMENT
FOR EC77 3KW 230V

RTC700284:

MBM- EUROTEC SRL
- DIV. COOKING
SERVICE



1101788 RESISTEN

ZA FRY-TOP 1370W
230V /
FRY-TOP HEATING
ELEMENT 1370W

230V

270200662:

GICO SPA

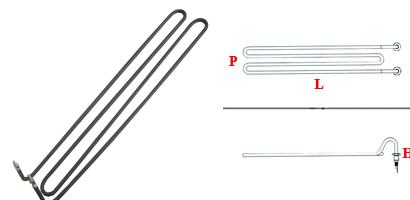

1101251 RESISTEN

ZA 1500W/230V A .PO
/
HEATING ELEMENT
A.PO 1500W/230V

32G1921:

ANGELO PO
GRANDI CUCINE
SPA

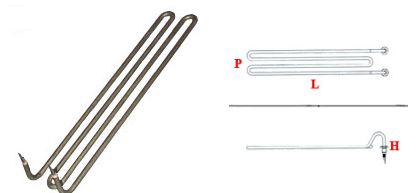

1101641 R.EFT47

1,35KW240 /
HEATING ELEMENT
1,35KW 240

RTC700278:

MBM- EUROTEC SRL
- DIV. COOKING
SERVICE

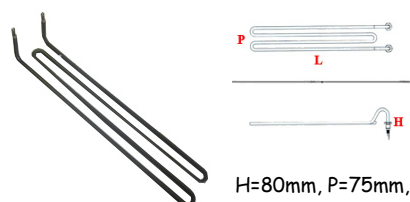

H=80mm, P=75mm,
L=450mm

1101258 RESISTEN

ZA 1700W/400V
PIASTRA A.PO /
GRILL HEATING
ELEMENT A.PO
1700W/400V

32G1040:

ANGELO PO
GRANDI CUCINE
SPA

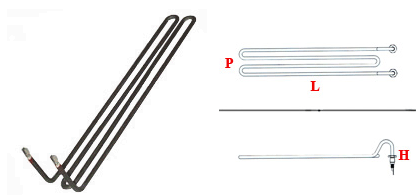

1101525 RESISTEN

ZA 1600W FRY-TOP
700 1G1K1N747002 /
HEATING ELEMENT
FRY-TOP 700
1G1K1N747002

MACM164800:

MARENO
INDUSTRIE ALI
SPA

CM164800:

MARENO
INDUSTRIE ALI
SPA

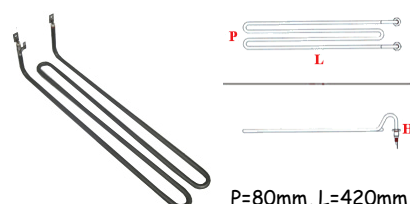

P=80mm, L=420mm,
H=115mm

1101252 RESISTEN

ZA 1750W/230V A.PO /
HEATING ELEMENT
A.PO 1750W/230V

32G0251:

ANGELO PO
GRANDI CUCINE
SPA

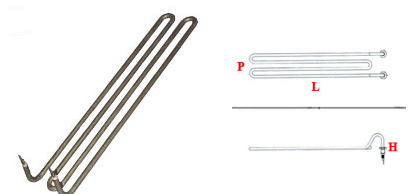

1101839 RESISTEN

ZA ELETTRICA EFT49
2KW240
1G1K1C139006 /
HEATING ELEMENT
EFT49 2KW240
1G1K1C139006

RTBF800038:

MBM- EUROTEC SRL
- DIV. COOKING
SERVICE

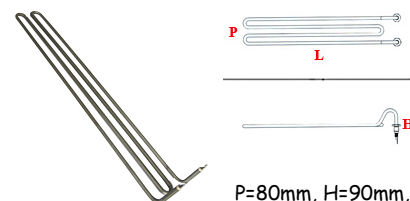

P=80mm, H=90mm,
L=570mm

1101253 RESISTEN

ZA 2000W/230V A.PO /
HEATING ELEMENT
A.PO 2000W/230V

32G2481:

ANGELO PO

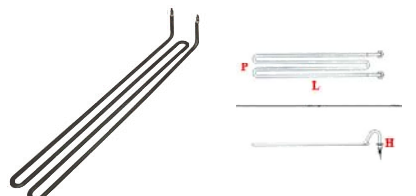

1101259 RESISTEN

ZA 2200W/400V
PIASTRA A .PO /
GRILL HEATING
ELEMENT A.PO
2200W/400V

32G1870:

ANGELO PO
GRANDI CUCINE
SPA



L=572mm, P=81mm,
H=85mm

1101690 RESISTEN

ZA CORAZZATA
2020W 230V /
HEATING ELEMENT
2020W 230V

290200112:

GICO SPA

290200112:

MBM- EUROTEC SRL
- DIV. COOKING
SERVICE

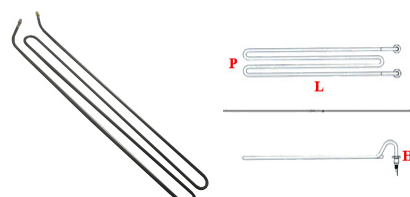

S&P Cooking Catalogue 2017

1101262 RESISTEN
ZA 1450W/230
BAGNOMARIA A.PO /
BAIN-MARIE
HEATING ELEMENT
A.PO 1450W/230V
32G0280:
ANGELO PO
GRANDI CUCINE
SPA

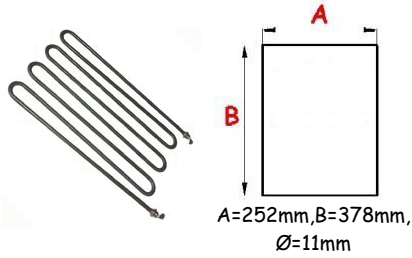

H=40mm, L=590mm

1101327 RESISTEN
ZA 230V 1450W CB /
HEATING ELEMENT
230V 1450W CB
GIRARROSTO EP12:
CB SRL

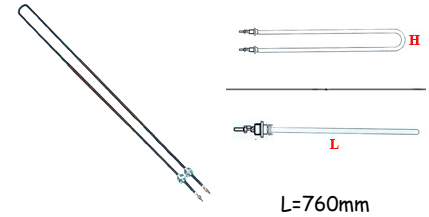

L=760mm

1101849 RESISTEN
ZA 800W.220V /
HEATING ELEMENT
800W 220V
32G0090:
ANGELO PO
GRANDI CUCINE
SPA



H= 60 mm, L=400mm

1101329 RESISTEN
ZA 230V 1500W CB
L580 /
HEATING ELEMENT
230V 1500W CB L580
G GV16/20: CB SRL



H=45mm, L=580mm

1101331 RESISTEN
ZA 230V 1600W CB /
HEATING ELEMENT
230V 1600W CB
ECV 1050: CB SRL

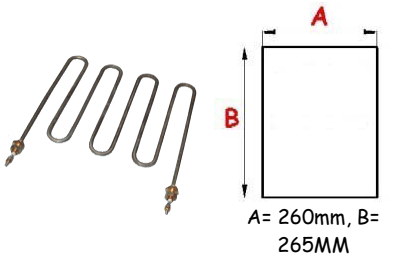

A= 260mm, B= 265MM

1101368 RESISTEN
ZA 230V 1900W
L=670mm /
HEATING ELEMENT
230V 1900W L=690mm
07031230EX: CB SRL
07032324: CB SRL



H=40mm, L=755mm

1101333 RESISTEN
ZA 230V 1700W CB /
HEATING ELEMENT
230V 1700W CB
ECV/SELF-3110-
4143: CB SRL

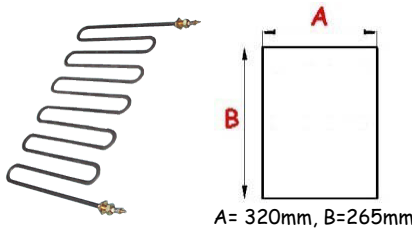

A= 320mm, B=265mm

1101328 RESISTEN
ZA 230V 2480W CB /
HEATING ELEMENT
230V 2480W CB
E 12P/20P -
GV35/70-
GV/GVP24/48:
CB SRL



L=760mm

1101332 RESISTEN
ZA 230V 2000W CB /
HEATING ELEMENT
230V 2000W CB
ECV/SELF-2076:
CB SRL

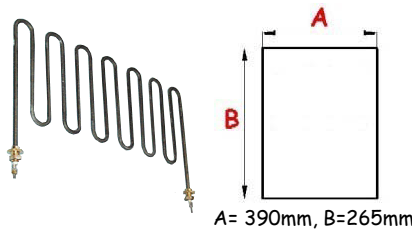

A= 390mm, B=265mm

1101224 RESISTEN
ZA 220V 3000W X
GIRARROSTI 24/96P /
HEATING ELEMENT
220V 3000W 24/96P
GIRARROSTI
24/96P: CB SRL

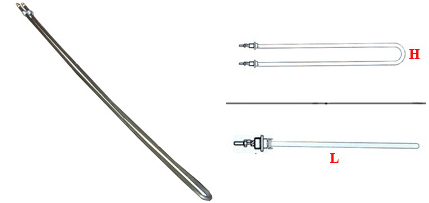

L=760mm

1101338 RESISTEN
ZA 230V 1200W
FORNI PIZZA CB /
HEATING ELEMENT
230V 1200W FOR
PIZZA OVEN CB
PIZZA F6-REV:
CB SRL

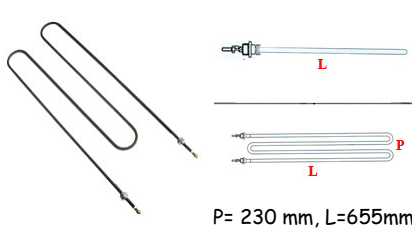

P= 230 mm, L=655mm

1101343 RESISTEN
ZA CUOCI WÜRSTEL
240V/200W /
HEATING ELEMENT
TO COOK WÜRSTEL
240V/200W
W24/7- W32/9:
CB SRL



1101583 RESISTEN
ZA 230V 1400W
L=590mm /
HEATING ELEMENT
1400W 230V
07030070: CB SRL

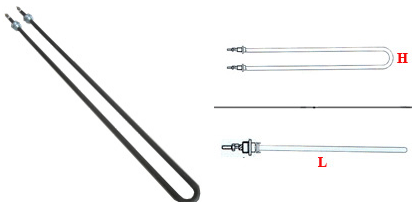

1101336 RESISTEN
ZA 230V 1450W
FORNI PIZZA CB /
HEATING ELEMENT
230V 1450W FOR
PIZZA OVEN CB
PIZZA CB500:
CB SRL

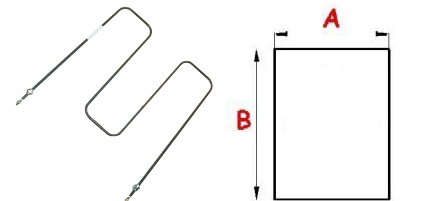

S&P Cooking Catalogue 2017

1101339 RESISTEN
ZA 230V 1900W
FORNI PIZZA CB /
HEATING ELEMENT
230V 1900W FOR
PIAZZA OVEN CB
PIZZA FP9: **CB SRL**

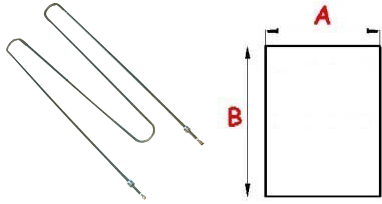

1101880 RESISTEN
ZA BAGNOMARIA
2500W/ 230V M14X1,5
/
BAIN-MARIE
HEATING ELEMENT
2500W/V M14X1,5

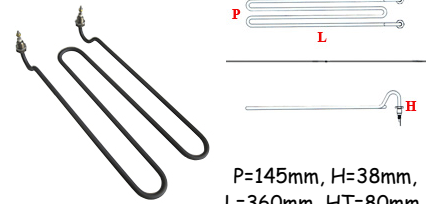

P=145mm, H=38mm,
L=360mm, HT=80mm,
M14X1,5

1101337 RESISTEN
ZA 230V 2000W
FORNI PIZZA CB /
HEATING ELEMENT
230V 2000W FOR
PIZZA OVEN CB
PIZZA CB FP4:
CB SRL

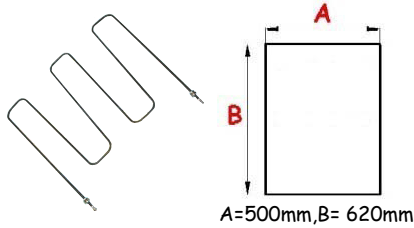

A=500mm, B= 620mm

1101568 RESISTEN
ZA BAGNOMARIA
GICO 2700W /
BAIN-MARIE
HEATING ELEMENT
GICO 2700W
270204530:
GICO SPA

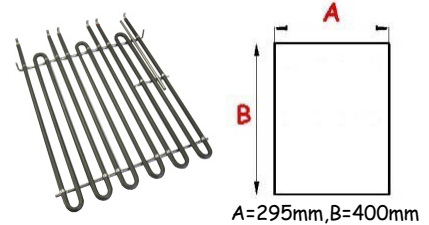

A=295mm, B=400mm

1101430 RESISTEN
ZA: 1900W 220V /
HEATING ELEMENT
1900W 220V
056783:
ELECTROLUX
PROFESSIONAL
S.P.A.

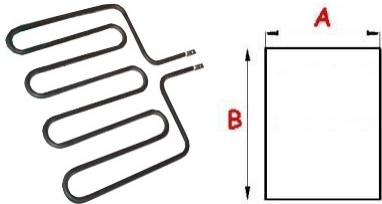

1101861 RESISTEN
ZA 1500W 230V PER
CUOCIPASTA /
HEATING ELEMENT
1500W/230V FOR
PASTA-COOKING
Y19800:
GIGA GRANDI
CUCINE SRL



H=51mm, Ø=14mm,
L=300mm

1101173 RESISTEN
ZA 350W VETRINA
FABA /
WARM SHOW CASES
HEATING ELEMENT
350W FABA
PRF0030: **FABA SRL**

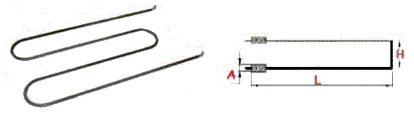

1101411 RESISTEN
ZA 2730W /
HEATING ELEMENT
2730W
6002066:
GIORIK SPA

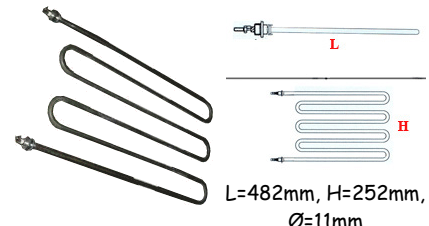

L=482mm, H=252mm,
Ø=11mm

1101174 RESISTEN
ZA VETRINA FABA
450W /
WARM SHOW CASES
HEATING ELEMENT
450W FABA
PRF0031: **FABA SRL**

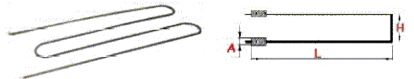

H=240mm, L=600mm

1101831 RESISTEN
ZA CORAZZATA SAL.
1200W 230V /
HEATING ELEMENT
1200W 230V
243200560:
GICO SPA

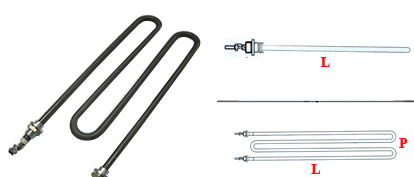

L=235mm, P=103mm

1101412 RESISTEN
ZA 3000W /
HEATING ELEMENT
3000W
6003052:
GIORIK SPA

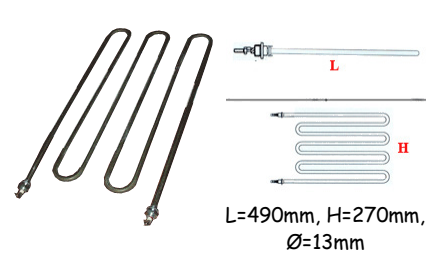

L=490mm, H=270mm,
Ø=13mm

1101850 RESISTEN
ZA BAGNO MARIA -
SELF-SERVICE 1300W
230V /
BAIN MARIE
HEATING ELEMENT
1300W 230V
241200562:
GICO SPA

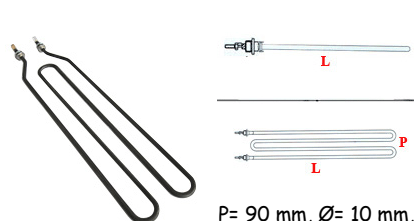

P= 90 mm, Ø= 10 mm,
L= 365 mm

1101678 RESISTEN
ZA CIELO W700 V.400
MF4/8 /
HEATING ELEMENT
SKY V.400 MF4 W700
/ 8
EE13400:
OEM ALI SPA

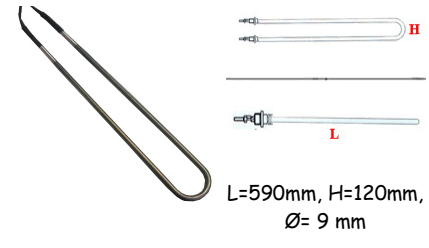

L=590mm, H=120mm,
Ø= 9 mm

S&P Cooking Catalogue 2017

1101775 RESIST.PL

ATEA W600 V.400
MF4-8 /
HEATING ELEMENT
PLATEA W600 V.400
MF4-8

EE13500:

OEM ALI SPA

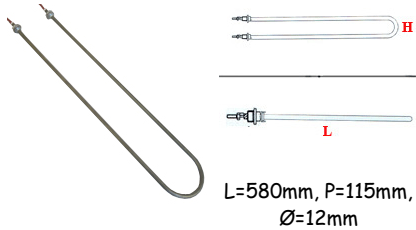

L=580mm, P=115mm,
Ø=12mm

1101715 RESISTEN

ZA W.875 V.230
F.635L TN /
HEATING ELEMENT
W.875 V.230 F.635L
TN

EE29400:

OEM ALI SPA

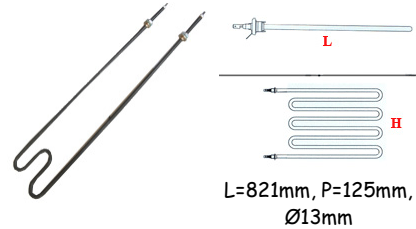

L=821mm, P=125mm,
Ø13mm

1101790 RESISTEN

ZA W.900 V.230
PLATEA F.32 /
HEATING ELEMENT
W.900 V.230 STALLS
F.32

EE10500:

OEM ALI SPA

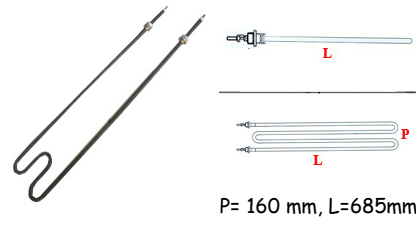

P= 160 mm, L=685mm

1101188 RESISTEN

ZA 900W 400V F.23-
MF5-9 /
HEATING ELEMENT
900W 400V F.23-MF5-9

EE11100:

OEM ALI SPA



L= 980mm, P= 120mm

1101718 RESISTEN

ZA W.900 V400
PLATEA F.32 /
HEATING ELEMENT
900W V400 F.32

EE10700:

OEM ALI SPA

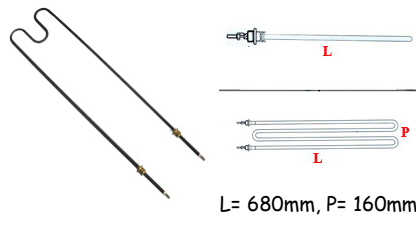

L= 680mm, P= 160mm

1101860 RESISTEN

ZA BAGNOMARIA
1000 W 230 V L 455
mm A 180 mm /
HEATING ELEMENT
BAIN MARIE 1000W
230V L 455 mm 180
mm

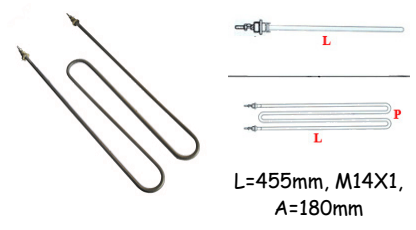

L=455mm, M14X1,
A=180mm

1101878 RESISTEN

ZA W.1000 V.230 F635
XL TN /
HEATING ELEMENT
1000W 230V F635 XL
TN

EE29500:

OEM ALI SPA

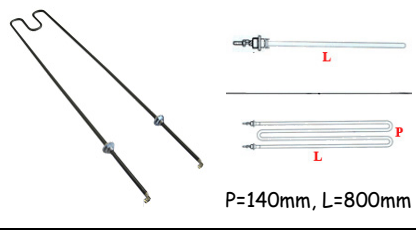

P=140mm, L=800mm

1101719 RESISTEN

ZA W.1100 V.230 F.435
TN /
HEATING ELEMENT
W.1100 V.230 F.435 TN

EE29300:

OEM ALI SPA

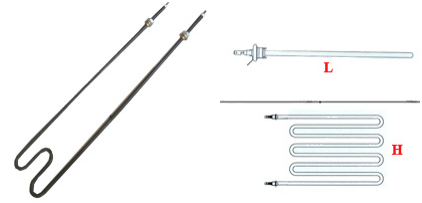

1101189 RESISTEN

ZA 1100W 400V F.23
MF9 /
HEATING ELEMENT
1100W 400V F.23 MF9

EE11000:

OEM ALI SPA



L= 980mm, P= 120mm

1101606 RESISTEN

ZA W.1100 V.400
F.96M /
HEATING ELEMENT
W.1100 V.400 F.96M

EE10600:

OEM ALI SPA



P=157mm, L=683mm,
Ø=16mm

1101700 RES.W.115

0 V230 CIELO TL105
TN /
HEATING ELEMENT
1150W 230V CIELO
TL105 TN

EE25500:

OEM ALI SPA

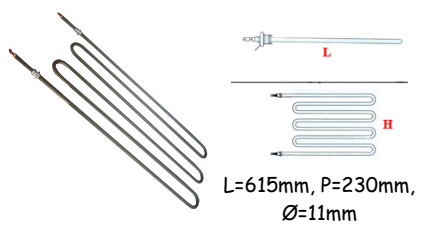

L=615mm, P=230mm,
Ø=11mm

1101513 RESISTEN

ZA FORNO FRE111
1150W 400V /
OVEN HEATING
ELEMENT FRE111

EE17400:

OEM ALI SPA



H=190mm, L=1200mm

1101640 RESISTEN

ZA W.1300 V.230
F69M+E /
HEATING ELEMENT
W.1300 V.230 F69M +
E

EE24600:

OEM ALI SPA



L=980mm, P=145mm,
Ø=16mm

1101666 RESISTEN

ZA W.1300 V.230
F96M+E /
HEATING ELEMENT
W1300 V320 F96M+E

EE24700:

OEM ALI SPA



P=116mm, L=685mm,
Ø=16mm

S&P Cooking Catalogue 2017

1101662 RESISTEN
ZA CIELO W.1300
V.400 F.69M /
HEATING ELEMENT
HEAVEN W.1300
V.400 F.69M

EE14900:
OEM ALI SPA

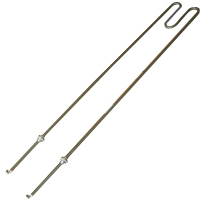

1101856 RESISTEN
ZA W.2100 V.400
F34H+109M /
HEATING ELEMENT
W.2100 V400 F34H +
109M

EE15100:
OEM ALI SPA

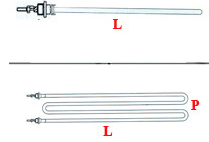

P= 162mm, Ø= 16mm,
L= 1280mm

1101669 RESIST.W.
1300 V.400
F.32H+96MC /
HEATING ELEMENT
1300W 400V F.32H +
96MC

EE12800:
OEM ALI SPA

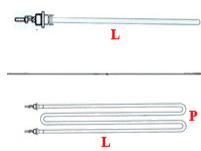

P=160mm, L=680mm,
Ø=17mm

1101654 RESIST.W2
200 V230
430+4DS+MF3 /
HEATING ELEMENT
2000W 230V

EE28200:
OEM ALI SPA

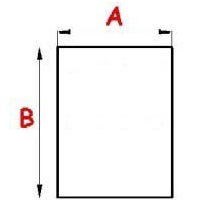
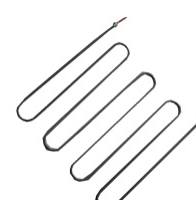

A=570mm, B=600mm

1101877 RESISTEN
ZA W.1600 V.230 5-
10DS /
HEATING ELEMENT
1600W 230V 5-10DS

EE24400:
OEM ALI SPA

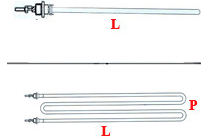

L=895mm,
L Totale=985mm,
P=210mm

1101906 RESISTEN
ZA BANCO CALDO
2186 W 230 V /
HEATING ELEMENT
2186 W 230 V

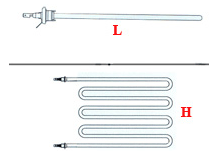

H=270mm, L=447mm

1101707 RESISTEN
ZA W1600 V.400
F.33M-99M PL /
HEATING ELEMENT
1600W 400V

EE11400:
OEM ALI SPA

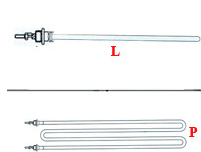

L=985mm, P=162mm

1101717 RESISTEN
ZA 15000W 230V
BOILER
1GEL8T569001 /
15000W 230V BOILER
HEATING ELEMENT
1GEL8T569001

BN6A037484:
OLIS DIVISIONE
DI ALI GROUP SPA -



1101586 RESIST.W.
1900 V.400 33H+99M-
C. /
HEATING ELEMENT
1900W 400V
33H+99MC

EE15000:
OEM ALI SPA

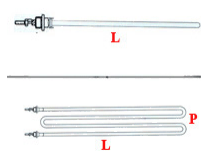

P=165mm, L=985mm,
Ø=16,5mm

1101865 "RESISTEN
ZA CPE ""65"" ""60""
3000W 230V" /
HEATING ELEMENT
3000W 230V - CPE

66503200:
MODULAR SPA

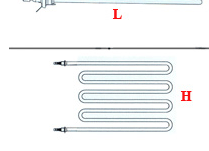

H=155mm, Ø=10mm,
L=302mm

1101659 RESISTEN
ZA W.2000 V.230
F99M+E /
HEATING ELEMENT
2000W 230V F99M+E

EE24800:
OEM ALI SPA

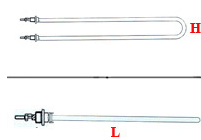

H= 165 mm,
L=984mm, Ø= 17 mm

1101629 RESISTEN
ZA 833W 230V /
HEATING ELEMENT
833W 230V

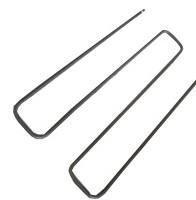

1101695 RESISTEN
ZA CORAZZATA AD
EMME 850W 230V /
HEATING ELEMENT
"M" SHAPED 850W
230V

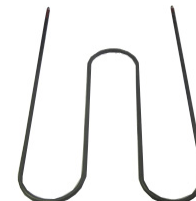

S&P Cooking Catalogue 2017

1101825 RESISTEN
ZA CORAZZATA AD
EMME 1500W 230V /
HEATING ELEMENT
"M" SHAPED 1500W
230V

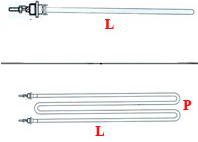

P=110mm, L=240mm,
GASKET=2101007,
D=12mm

1101851 RESISTEN
ZA A SECCO 1600 W
230 V 220mmX220mm
/
DRY HEATING
ELEMENT 1600W
230V 22 mX220mm

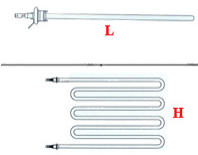

H= 235mm, Ø= 10mm,
L= 220mm

1101872 RESISTEN
ZA ELETTRICA A
SECCO 900 W 230 V /
HEATING ELEMENT
900 W 230 V

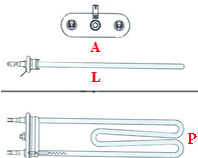

P=180mm, L=420mm
A=70X22mm

1101638 HEATING
ELEMENT KBM
1300W 230V 1GIK /
HEATING ELEMENT
KBM 1300W 230V
1GIK

MA1037039613:
MARENO
INDUSTRIE ALI
SPA

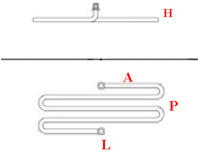

P=130mm, L=290mm,
A=150mm, H=18mm

1101919 RESISTEN
ZA 1000W 230V /
HEATING ELEMENT
1000W 230V

MA1037039513:
MARENO
INDUSTRIE ALI
SPA

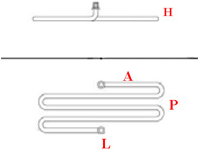

P=83mm, A=150mm,
H=25mm, L=295mm

1101256 RESISTEN
ZA 800W/230V A.PO /
HEATING ELEMENT
A.PO 800W/230V

32G0160:
ANGELO PO
GRANDI CUCINE
SPA

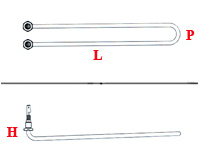
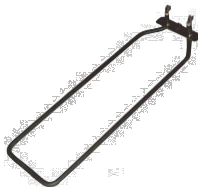

1101257 RESISTEN
ZA 2600W/400V A.PO /
HEATING ELEMENT
A.PO 2600W/400V

32G1350:
ANGELO PO
GRANDI CUCINE
SPA

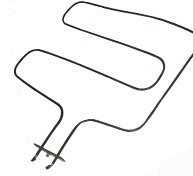

1101311 RESISTEN
ZA 2600W 230V /
HEATING ELEMENT
2600W 230V

32G1591:
ANGELO PO
GRANDI CUCINE
SPA

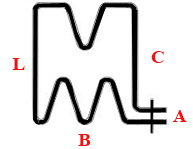

1101552 RESISTEN
ZA 2700W 400V /
HEATING ELEMENT
2700W 400V

32G0951:
ANGELO PO
GRANDI CUCINE
SPA

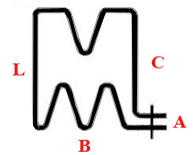
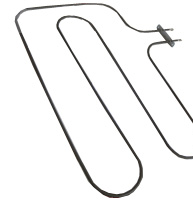

1101663 RESISTEN
ZA 2600W 230V /
HEATING ELEMENT
2600W 230V

32G1601:
ANGELO PO
GRANDI CUCINE
SPA

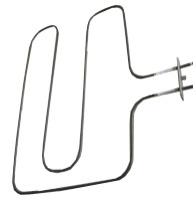

1101870 RESISTEN
ZA 2600W 400V /
HEATING ELEMENT
2600W 400V

32G1621:
ANGELO PO
GRANDI CUCINE
SPA

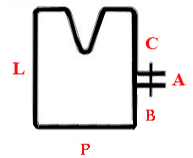

L=510mm, A=60mm,
B=155mm, P=158mm,
C=290mm,
FLANGIA:100X22mm

1101871 RESISTEN
ZA 2700W 400V /
HEATING ELEMENT
2700W 400V

32G3250: ANGELO
PO GRANDI CUCINE
SPA

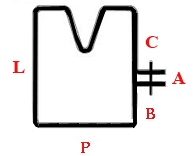
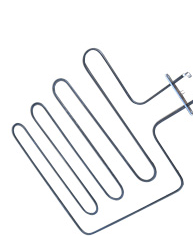

P=370mm, A=60mm,
B=150mm, L=385mm,
C=170mm,
FLANGIA:100X22mm

S&P Cooking Catalogue 2017

1101915 RESISTEN
ZA 2700W. 230V /
HEATING ELEMENT
2700W 230V
3003790:
ANGELO PO
GRANDI CUCINE
SPA

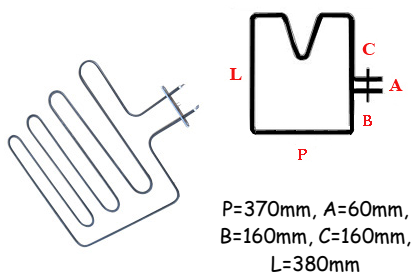

1101756 RESISTEN
ZA W.3000 V.400
PF45HT+MT /
HEATING ELEMENT
3000W 400V
PF45HT+MT
EE16200:
OEM ALI SPA

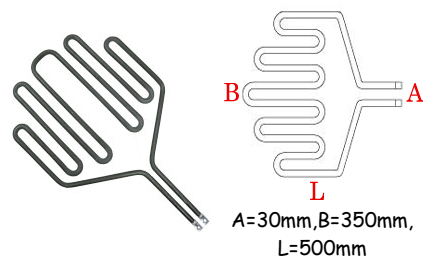

1101335 RESISTEN
ZA 230V 2500W CB /
HEATING ELEMENT
230V 2500W CB
GOLOSO 4 GRILL:
CB SRL

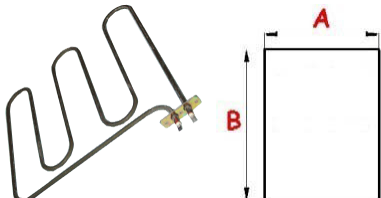

1101263 RESISTEN
ZA 1000W/230
BAGNOMARIA A.PO /
BAIN-MARIE
HEATING ELEMENT
A.PO 1000W/230V
3262220:
ANGELO PO
GRANDI CUCINE
SPA

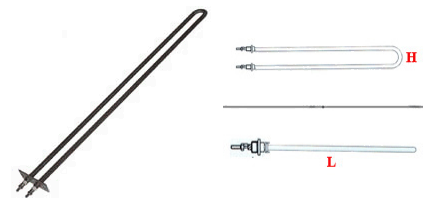

1101062 RESISTEN
ZA ZANUSSI 053577 /
HEATING ELEMENT
ZANUSSI 053577
053577:
ELECTROLUX
PROFESSIONAL
S.P.A.



1101665 RESISTEN
ZA FORNO MORETTI
700 W 220 V L 712 mm
W 80 mm /
HEATING ELEMENT
FOR MORETTI OVEN
700W 220V L 712mm



1101505 RESISTEN
ZA FORNO 2200W /
HEATING ELEMENT
FOR OVEN 2200W
C10192:
EMMEPI GRANDI
CUCINE S.R.L.

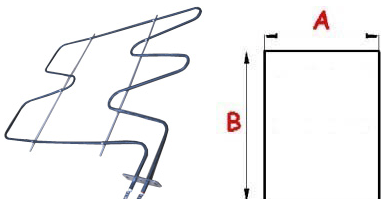

1101518 "RESISTEN
ZA: 1350W 225V" /
HEATING ELEMENT
1350W 225V
056906:
ELECTROLUX
PROFESSIONAL
S.P.A.

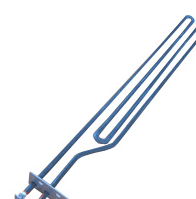

1101866 RESISTEN
ZA FORNO 2500W -
230V"UNIFICATA" /
OVEN HEATING
ELEMENT 2500W -
230V
C10194:
EMMEPI GRANDI
CUCINE S.R.L.

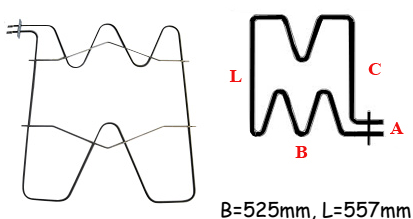

1101793 "RESISTEN
ZA: 230V 1650W" /
HEATING ELEMENT;
230V 1650W
006853:
ELECTROLUX
PROFESSIONAL
S.P.A.



1101779 RESIST.
CORAZ. FORNO
2740W 400V /
OVEN HEATING
ELEMENT 2740W
400V
270203360:
GICO SPA

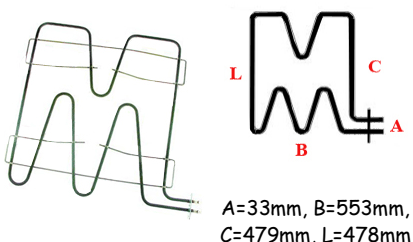

1101892 RESISTEN
ZA
CUOCIPASTA.CPT-
64E 5000W 3-230V /
PASTA COOKER
HEATING ELEMENT
CPT 64E 500W 3-230V
537035901:
LOTUS SPA

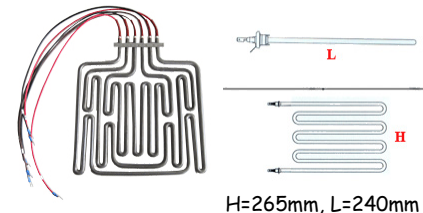

1101720 RESISTEN
ZA W.1500 V.400
PF/33 /
HEATING ELEMENT
W.1500 V.400 PF/33
EE18100:
OEM ALI SPA



1101646 R.FEC100
2,5KW240
1GIK2.R853.002 /
HEATING ELEMENT
FEC100 2,5KW240
1GIK2.R853.002
RTFOC00068:
MBM- EUROTEC SRL
RTFOC00068:
ELETTROBAR



1101822 RESISTEN
ZA BRASIERA 5000W

/
BRATT PAN
HEATING ELEMENT
5000W

CR0683221:

MARENO
INDUSTRIE ALI
SPA

CR0683221:

SILKO ALI SPA

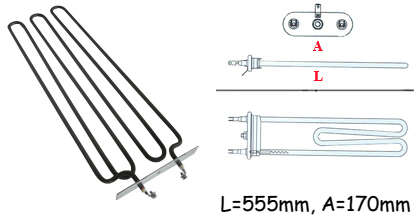

L=555mm, A=170mm

22015500:

BERTO'S SPA

1101109 RESISTEN

ZA FORNO 2600W
240V d.190 /
OVEN HEATING
ELEMENT 3000W
240V

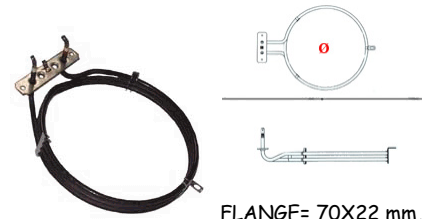

FLANGE= 70X22 mm,
Ø 190mm

1101899 RESISTEN

ZA ELETTRICA
SALAMANDRA
2000W 230V /
HEATING ELEMENT
2000W 230V

RC00003706:

TECNOINOX SRL

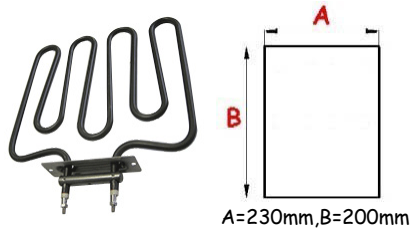

A=230mm, B=200mm

1101389 RESISTEN

ZA FORNO .EF0V7
2,6KW 230V
1GIK3L698002 /
HEATING ELEMENT
OVEN. EF0V7 2.6
KW2301GIK3L698002

RTC0700650:

MBM- EUROTEC SRL
- DIV. COOKING
SERVICE

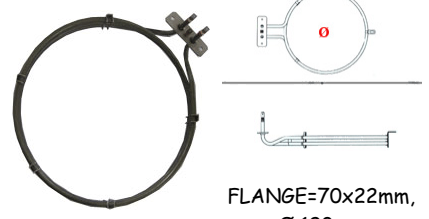

FLANGE=70x22mm,
Ø 190mm

1101697 RESISTEN

ZA BAGNOMARIA
700W 230V A SECCO /
DRY BAINE-MARIE
HEATING ELEMENT
700W 230V

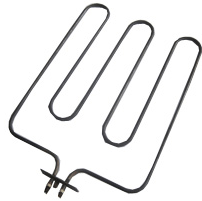

1101681 RESISTEN

ZA CIRCOLARE
FORNO 1550 W 230 V /
HEATING ELEMENT
OVEN 1550W 230V

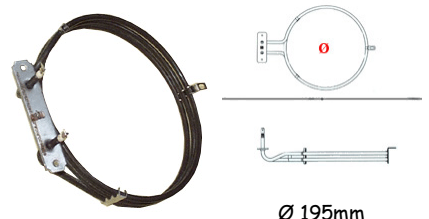

Ø 195mm

1101658 RESISTEN

ZA FORNO 3000W
230V /
OVEN HEATING
ELEMENT 3000W
230V

055503:

ELECTROLUX
PROFESSIONAL
S.P.A.

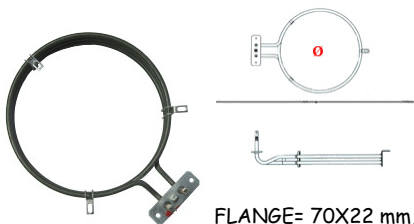

FLANGE= 70X22 mm,
Ø 183mm

1101844 RESISTEN

ZA CIRCOLARE1600
W 230 V D195MM /
CIRCULAR HEATING
ELEMENT 1600W
230V D.195MM

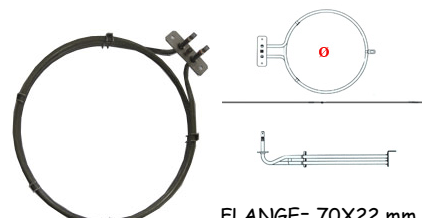

FLANGE= 70X22 mm,
Ø 195mm

1101107 RESISTEN

ZA FORNO 220V
054843 2500W /
OVEN HEATING
ELEMENT 220V
054843

054843:

ELECTROLUX
PROFESSIONAL
S.P.A.

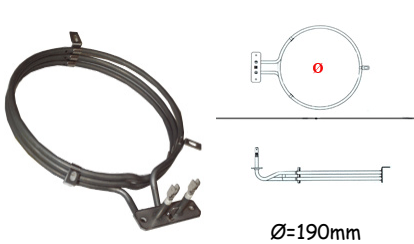

Ø=190mm

1101334 RESISTEN

ZA 230V 2580W CB /
HEATING ELEMENT
230V 2580W CB
GOLOSO4 BAKE /
CHEF: CB SRL

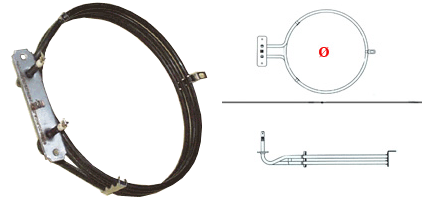

Ø=190mm

1101192 RESISTEN

ZA 2500W 240V D. 190
/
HEATING ELEMENT
2500W 240V D. 190

X68002:

GIGA GRANDI
CUCINE SRL
004934:

ELECTROLUX
PROFESSIONAL
S.P.A.

MA7800400:

MARENO
INDUSTRIE ALI
SPA

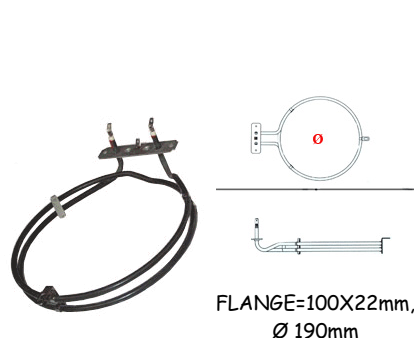

FLANGE=100X22mm,
Ø 190mm

1101283 RESISTEN

ZA 2000W 230V 2
SPIRE D. 200 /
HEATING ELEMENT
2000W 230V D. 200

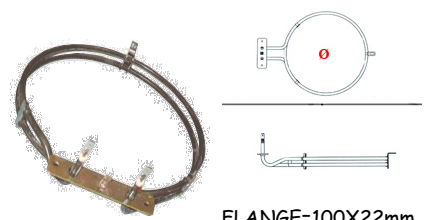

FLANGE=100X22mm,
Ø = 200 mm, 2000 W

S&P Cooking Catalogue 2017

1101520 RESISTEN
ZA CIRCOLARE
FORNO 3300W /
OVEN HEATING
ELEMENT 3300W
RES017:
GARBIN
INDUSTRIES SRL

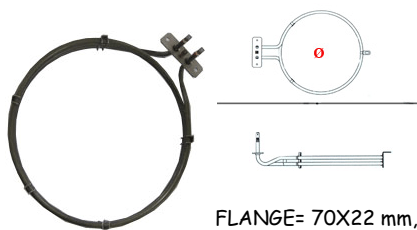

FLANGE= 70X22 mm,
Ø=235mm

1101413 R.FEC065
7,5KW240
1GIK3M134001 /
HEATING ELEMENT
FEC065 7,5KW240
1GIK3M134001
RTFOC00433:
MBM- EUROTEC SRL
- DIV. COOKING
SERVICE

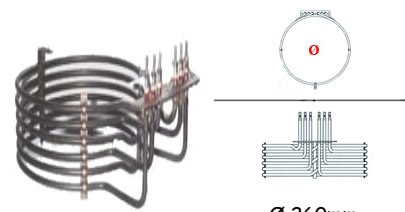

Ø 260mm

1101624 RESISTEN
ZA FORNO 2000W X 2
230V /
OVEN HEATING
ELEMENT 2000W X 2
230V
RES000:
GARBIN
INDUSTRIES SRL

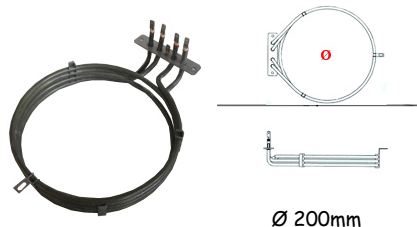

Ø 200mm

1101097 RESISTEN
ZA EL.TRIFASE
CIRCOLARE 7500W/
CIRCULAR THREE-
PHASE HEATING
ELEMENT 7500W
R65011540:
LAINOX ALI SPA
LAR65011540:
LAINOX ALI SPA

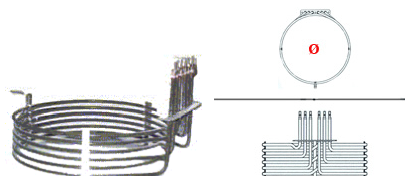

Ø=265mm, 7500 W

1101096 RESISTEN
ZA 5400W 230V
LAINOX /
HEATING ELEMENT
5400W 230V LAINOX
R65011500:
LAINOX ALI SPA
LAR65011500:
LAINOX ALI SPA

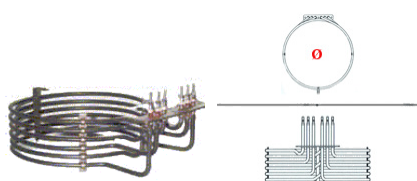

FLANGE=140X22mm,
Ø 203mm

1101901 RESISTEN
ZA FORNO 8000W
230V /
OVEN HEATING
ELEMENT 8000W
230V

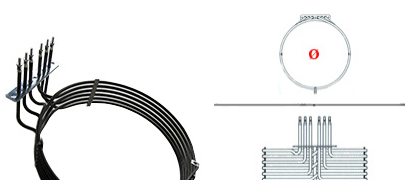

FLANGE=142X25mm,
Ø=300mm

1101810 RESISTEN
ZA 4000W /
HEATING ELEMENT
4000W
RES015:
GARBIN
INDUSTRIES SRL

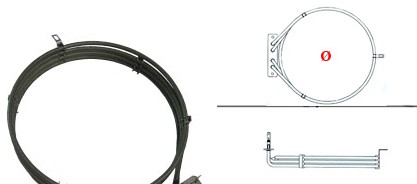

FLANGE=100X22mm,
Ø=220mm

1101290 RESISTEN
ZA 8700W/230V APO /
HEATING ELEMENT
8700W/230V APO
32G1691:
ANGELO PO
GRANDI CUCINE
SPA

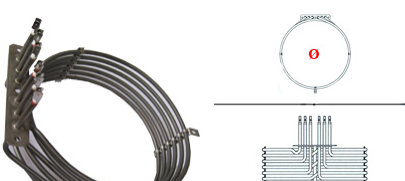

Ø =330mm

1101795 RESISTEN
ZA W6000 V 230 /
HEATING ELEMENT
W6000 V 230
6002111:
GIORIK SPA

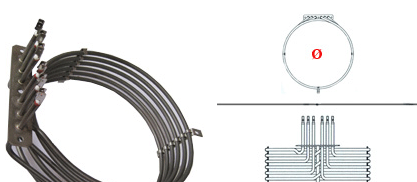

Ø=230mm

1101466 RESISTEN
ZA CAMERA 15000W /
HEATING ELEMENT
15000W
R65011310:
LAINOX ALI SPA
LAR65011310:
LAINOX ALI SPA

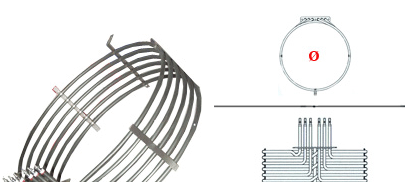

FLANGE=140X25mm,
Ø 405mm

1101291 RESISTEN
ZA 4100W-230V APO
D.248mm H70mm /
HEATING ELEMENT
4100W-230V APO
D.248mm H70mm
32G1940:
ANGELO PO
GRANDI CUCINE
SPA



Ø 248mm

1101226 RESISTEN
ZA 16.4KW230V A.PO
32G1701 /
HEATING ELEMENT
16.4KW230V A.PO
32G1701
32G1701:
ANGELO PO
GRANDI CUCINE
SPA

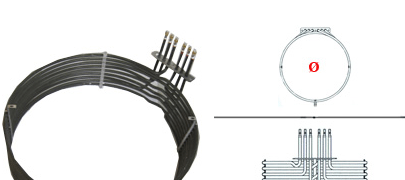

Ø 455mm

S&P Cooking Catalogue 2017

1101816 RESISTEN
ZA CAMERA 21000W /
CHAMBER HEATING
ELEMENT 21000W
LAR65011280:
LAINOX ALI SPA

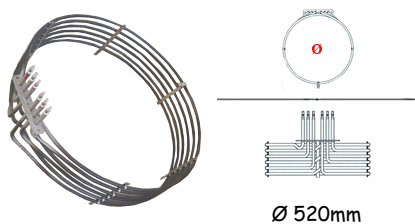

Ø 520mm

1101784 RESISTEN
ZA 650 W 230 V PER
CUOCIWURSTEL /
HEATING ELEMENT
650 W 230 V FOR HOT
DOG COOKER

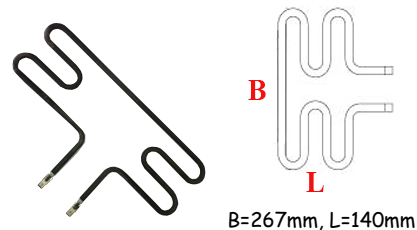

B=267mm, L=140mm

1101635 "RESISTEN
ZA; 400V-5670W; KIT"
/
HEATIN ELEMENT
400V-5670W
OC5364:
ELECTROLUX
PROFESSIONAL
S.P.A.



1101618 RESISTEN
ZA 1500W 230V
KEBAB /
HEATING ELEMENT
FOR KEBAB 1500W
230V

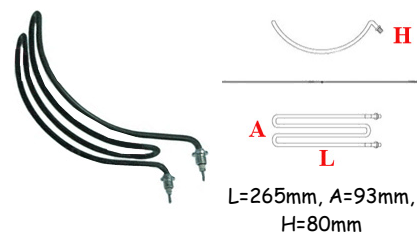

L=265mm, A=93mm,
H=80mm

1101656 "RESISTEN
ZA; 8KW 400V" /
HEATING ELEMENT
8KW 400V
OA5330:
ELECTROLUX
PROFESSIONAL
S.P.A.



1101590 RESISTEN
ZA FRY TOP EMMEPI
1000W /
FRY TOP HEATING
ELEMENT EMMEPI
1000W
C10199:
EMMEPI GRANDI
CUCINE S.R.L.

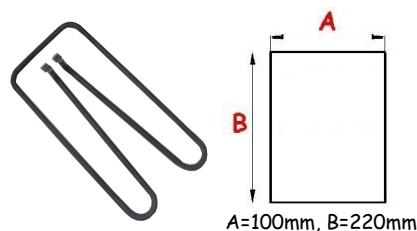

A=100mm, B=220mm

1101794 RESISTEN
ZA 900W 230V PER
FORNO /
OVEN HEATING
ELEMENT 900W 230V



L=260mm, H=115mm,
Ø=11mm, Ø200mm

1101161 RESISTEN
ZA 4800W 220V A.PO /
HEATING ELEMENT
4800W 220V A.PO
32G0650:
ANGELO PO
GRANDI CUCINE
SPA

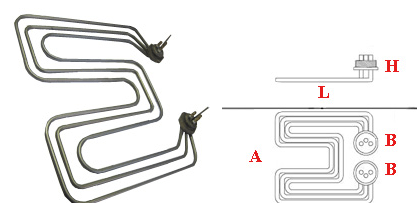

1101113 RESISTEN
ZA CREPIERES 2000W
230V /
CREPIERE HEATING
ELEMENT 2000W
230V
PR30001: FABBA SRL



Ø 300mm

1101193 RESISTEN
ZA X
CIOCCOLATIERA
COMPL. DI
GUARNIZIONE /
CHOCOLATE POT
HEATING ELEMENT
WITH GASKET
SL3000990004:
GBG ALI SPA
99004+6606:
GBG ALI SPA
SL3000990004:
GBG ALI SPA

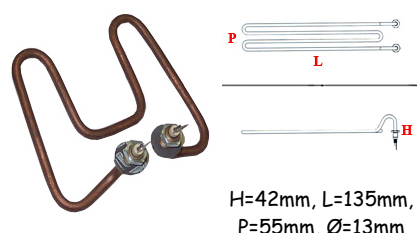

H=42mm, L=135mm,
P=55mm, Ø=13mm

1101777 RESIST.W.
3600 V.400 X P.D.400 /
HEATING ELEMENT
3600W 400V X P.D.400
EE27000:
OEM ALI SPA



Ø 400mm

1101684 RESIST.W.
3600 V.400 X P.D.450 /
HEATING ELEMENT
3600W V400 X-P
D.450
EE27100:
OEM ALI SPA

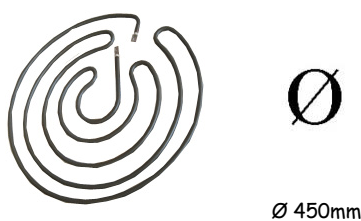

Ø 450mm

1101884 RESISTEN
ZA PER
TERMOSIGILLATRIC
E 900W 230V /
THERMOSEALING
HEATING ELEMENT
900W 230V

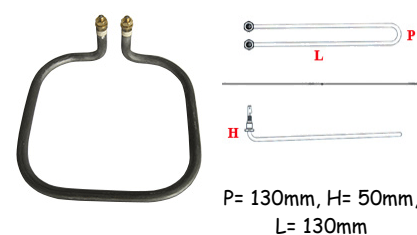

P= 130mm, H= 50mm,
L= 130mm

1101833 RESISTEN
ZA PER
VENTILATORI
TANGENZIALI 8L180
2000W-230V /
RESISTANCE TO
FANS TANGENZIALI
8L180 2x100W)



FAN=1103857,
FAN=1103856,
FAN=1103858

1101330 RESISTEN
ZA 240V 2 X 1000W
CB /
HEATING ELEMENT
240V 2X1000W CB
VR-EV-ESP/2:
CB SRL

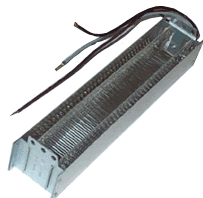

1101455 RESISTEN
ZA ALETTATA PER
AS 230V-1500W /
HEATING ELEMENT
FINNED - FOR AS
230V-1500W
110706:
COMENDA ALI SPA



P=50mm, H=25mm,
L=398mm

1101847 RESISTEN
ZA ELETTRICA 1000
W /
HEATING ELEMENT
1000W
3063250:
ANGELO PO
GRANDI CUCINE
SPA



H= 50 mm, L= 400mm

1101812 RESISTEN
ZA FILO MS082-282E /
HEATING ELEMENT
WIRE MS082-282E
LAR65014890 :
LAINOX ALI SPA



1101126 RESISTEN
ZA
AUTOREGOLAZIONE
+PTC MARENO /
AUTOREGULATION
HEATING
ELEMENT+PTC
MARENO
MA4646700:
MARENO
INDUSTRIE ALI
SPA
4646700:
SILKO ALI SPA



L=230mm

1101340 RESISTEN
ZA CARTUCCIA 230V
80W /
CARTRIDGE
HEATING ELEMENT
230V 80W
HOT DOG - TP:
CB SRL



1101084 RESISISTE
NZA ADESIVA 1000W
240V 32094
275X400MM /
HEATING ELEMENT
37X40CM 100W 240V
32094
032094:
ELECTROLUX
PROFESSIONAL
S.P.A.

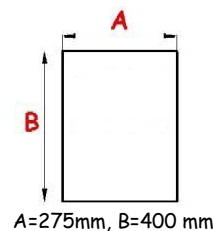

A=275mm, B=400 mm

1101900 RESISTEN
ZA ADESIVA 2500W
490X400MM MAX
175° /
HEATING ELEMENT
2500W 490X400MM
MAX 175°

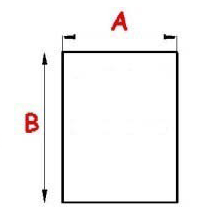

A=400mm B=490mm

1101881 RESISTEN
ZA+FOGLIO
ALLUMINIO P.CAL
400W 230V /
HEATING ELEMENT
400W 230V
M785500900:
MODULAR SPA

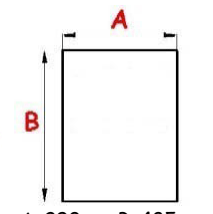
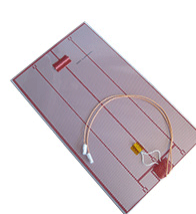

A=290mm, B=485mm

2101031 GUARNIZI
ONE OR D. 37X5.33 /
O RING D.37 47X5.33
907981:
SILANOS SRL
36404015:
RANCILIO SPA
103415:
KRUPPS S.R.L.
36401001:
RANCILIO SPA
29938:
HOONVED - ALI
SPA
456075:
ELETTROBAR

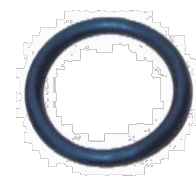

2101032 GUARNIZI
ONE OR D. 46 99X5.33
/
O RING D.46 99X5.33
*: MBM
2662: ARISTARCO
4207*: A.T.A. SRL
REB456002: LOTUS
0101176: MEIKO
067620:
ELECTROLUX
DW13005:
DIHR-ALI SPA
0L2765:
ELECTROLUX
0835534701 :
MODULAR SPA

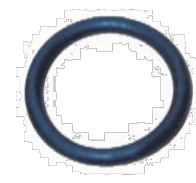

2101033 GUARNIZI

ONE OR D. 56 52X5.33
/ O RING D.56 52X5.33

200815:

COMENDA ALI SPA

7496029: BEZZERA

929046: COLGED

7496011: BEZZERA

3150430:

ANGELO PO

GRANDI CUCINE

SPA

DW13015:

DIHR-ALI SPA

200815:

HOONVED - ALI

SPA

0200041:

LAMBER SRL

33402:

HOONVED - ALI

SPA

12010040:

FAGOR

INDUSTRIALE

S.R.L.

TR0115:

SILANOS SRL

103435:

KRUPPS S.R.L.

103445:

KRUPPS S.R.L.

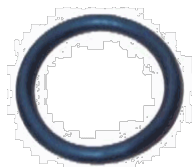

2101053 OR PER
RACCORDI MINISIT /
O-RING X MINISIT

0925034: SIT



2101097 OR
RUBINETTO /
OR TAP GBG

SL300000118:

GBG ALI SPA

118: GBG ALI SPA



2101817 GUARNIZI
ONE OR TAMPONE
AMB RL 6,5 /
O-RING AMB RL 6,5



2101795 O RING /
O RING

64004113:

SCOTSMAN ICE SRL



2102521 GUARNIZI

ONE
BRUCIATORE/SCAM
BIATORE /
GASKET

R63140060:

LAINOX ALI SPA

LAR63140060:

LAINOX ALI SPA

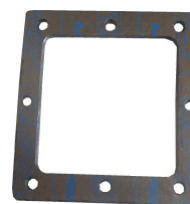

2102533 GUARNIZI

ONE CONDOTTO
FUMI /
SEAL CONDUCTED
SMOKE

R63140020:

LAINOX ALI SPA

LAR63140020:

LAINOX ALI SPA



2102554 GUARNIZI

ONE /
GASKET

007005:

ELECTROLUX

PROFESSIONAL

S.P.A.

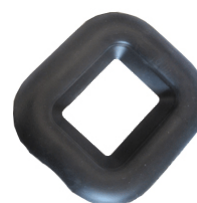

2102498 V-RING D.

14 VAP12-E2 /
V-RING D. 14 VA

75508: CEADO SRL

PR75508: FABA SRL



2102504 GUARNIZI

ONE GOMMA
BICCH.FRULL. /
RUBBER GASKET
FOR MIXER GLASS

C0007F323:

MACAP SRL

DW60183:

DIHR-ALI SPA



2102538 GUARNIZI

ONE PULSANTIERA
FELSINEA /
KEYBOARD GASKET
FELSINEA



2102155 GUARNIZI

ONE P/LAMPADA
FCV /
GASKET FOR FCV

161283: MBM

RTFOC00202:

MBM- EUROTEC SRL

- DIV. COOKING

SERVICE



2102897 GUARNIZI
ONE LAMPADA /
LAMP GASKET



DIMENSIONS
93X78X2,5mm

2102534 GUARNIZI
ONE /
GASKET

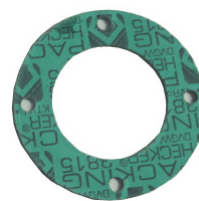

R63140050:
LAINOX ALI SPA
LAR63140050:
LAINOX ALI SPA

2102410 GUARNIZI
ONE
COPRILAMPADA
RETTANGOLARE /
GASKET FOR LAMP
RECTUANGULAR



AL032:
OEM ALI SPA
AL03220:
OEM ALI SPA

2102888 GUARNIZI
ONE ESENTE
14,5X6X2 PER DADO
3/8" /
GASKET D.14,5X6X2
FOR NUT 3/8"



2102409 GUARNIZI
ONE
COPRILAMPADA /
GASKET FOR LAMP



2102036 GUARNIZI
ONE RAME 3/8
23X17X1 /
TAP COPPER
GASKET 3/8 23X17X1



27350001:
RANCILIO SPA
12154:
CMA MACCHINE
PER CAFFE' SRL

2102500 GUARN.L
AMP.DI.32,5 D.E.55
SP12 /
GASKET FOR LAMP
DI.32,5 E.D.55
THICKNESS 12



AL26600:
OEM ALI SPA

2102146 GUARNIZI
ONE RAME 174
18X13,5X1 /
COPPER GASKET 174
18/13,5X1

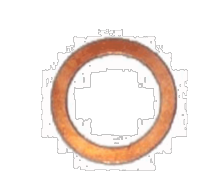

2102545 GUARNZI
ONE FRY TOP
K9EFR10PP0 /
SEAL FRY TOP
K9EFR10PP0
K00077: A.T.A. SRL



2102019 GUARNIZI
ONE RAME 21X27X1
1/2 /
COPPER GASKET
21X27X1 1/2

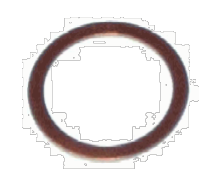

27400001:
RANCILIO SPA

2102109 GUARNIZI
ONE DUTRAL
18,5X10X3 F2 /
GASKET 18,5X10X3
F2



200415:
COMENDA ALI SPA
200415:
HOONVED - ALI
SPA

2102209 GUARNIZI
ONE SILICONE
RUBINETTI
DISPENSER /
SILICON GASKET
FOR COCK
DISPENSER



2102218 GUARNIZI
ONE ELEMENTO
SENSIBILE 19,5X15X3
/
GASKET FOR
SENSITIVE ELEMENT
19,5X15X3



2102267 GUARNIZI
ONE BULBO A.PO /
SEAL BULB A.PO
3150270:



ANGELO PO
GRANDI CUCINE
SPA

2102601 GUARNIZI
ONE 35x18x7 mm /
GASKET 35X18X7MM
3004400:
ANGELO PO
GRANDI CUCINE
SPA



EMMEPI GRANDI
CUCINE S.R.L.
10731: FOINOX
S.P.A.
66402500:
MODULAR SPA

2102893 GUARNIZI
ONE RIDUTTORE DI
PRESSIONE (GA282) /
GASKET PRESSURE
REDUCER (GA282)
AD26000:
OEM ALI SPA



DIMENSIONS
23,5X15,5X3mm

1103329 MOTOVEN
TILATORE CB /
FAN MOTOR CB
ECV/SELF: CB SRL



2102444 GUARNIZI
ONE SCANAL. TAMP.
TRESPADE KG. 7/10 /
GASKET TRESPADE
KG. 7/10



1103332 VENTILAT
ORE RADIALE 230V
CB /
RADIAL MOTOR
230V CB
GOLOS04: CB SRL
07010013+0141001:
CB SRL



2102542 GUARNIZI
ON D INTERNO 160
mm DIAMETRO
ESTERNO 200 mm /
SEAL INSIDE
DIAMETER 160 mm
OUTSIDE DIAMETER
200 mm

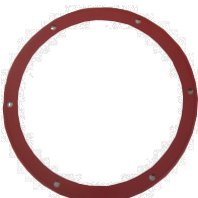

1103355 MOTORE+
VENTOLA FECO23
VN120 H25 25W /
MOTOR + FAN
FECO23 VN120 H25
RTFOC00623: MBM

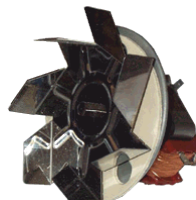

1103477 MOTORE
PER FORNI CON
VENTOLA 34W -h40- /
OVEN FAN MOTOR
48W
MA1037300300:
MARENO
INDUSTRIE ALI
SPA

RTFOC00623:
MBM- EUROTEC SRL
- DIV. COOKING
SERVICE
RTC700450:
MBM- EUROTEC SRL
- DIV. COOKING
SERVICE
RTC800153:
MBM- EUROTEC SRL
- DIV. COOKING
SERVICE
1037300300:
MARENO
INDUSTRIE ALI
SPA
BN6A036410:
OLIS DIVISIONE
DI ALI GROUP SPA
-
507007: GICO SPA
807206:

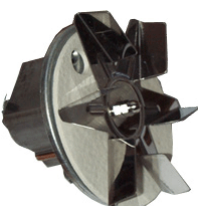

1103327 VENTILAT
ORE 230V 50HZ KLF /
FAN 230V 50HZ KLF
GE VENTILATO:
CB SRL

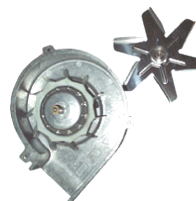

1103286 MOTORE
0,75KW APO /
MOTOR 0,75KW A.PO
32M4260:
ANGELO PO
GRANDI CUCINE
SPA

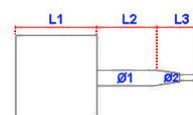
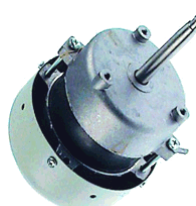

L2=38mm, L3=36mm,
Ø1=12mm, Ø2=10mm,
L1=120mm

1103756 ASSIEME
MOTORE 230/380 /
MOTOR ASSEMBLY
230/380
OD0887:
ELECTROLUX
PROFESSIONAL
S.P.A.



1103480 MOTORE
FORNO 1 VELOCITA'
230V 1057 /
MOTOR FOR OVEN 1
SPEED 230V

10705:

FOINOX S.P.A.

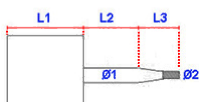

L1=120mm, L2=78mm,
L3=30mm, = 3109147,
Ø1=15mm, Ø2=10mm
FAN= 3109147

FAN=3109147,
Ø1=15mm, Ø2=10mm
FAN=3109147

1103911 MOTORE
ASINCRONO
MONOFASE 1-V
0,25HP 200-240V /
MOTOR 1071.3250
0.25HP 200/240V

293200840:

GICO SPA



fan=1103912

1103393 MOTORE
LAINOX R65040071 /
MOTOR LAINOX
R65040071

R65040071:

LAINOX ALI SPA

LAR65040071:

LAINOX ALI SPA



1103384 MOTORE /
MOTOR

R65040011:

LAINOX ALI SPA

LAR65040011:

LAINOX ALI SPA



1103705 MOTORE
1057.2155 0,37KW
230V s/condensatore /
MOTOR 1057.2155
0,37KW 230V

LAR65040420:

LAINOX ALI SPA



1103707 MOTORE
1057C2401 0,25KW
230V s/condensatore /
MOTOR 1057C2401
0,25KW 230V

LAR65040421:

LAINOX ALI SPA



1103850 MOTORE
0.25HP 230V 50HZ
1400/1700RPM /
MOTOR 0.25HP 230V
50HZ 1400/1700RPM

LAR65040021:

LAINOX ALI SPA

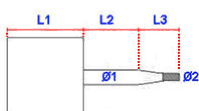

L1=105mm, L2=77mm,
L3=31mm,

1103462 MOTORE
PER FORNO DOPPIA
VELOCITA' 0,5/0,1HP
/

MOTOR 2 SPEED FOR
OVEN

LAR65040260:

MARENO

INDUSTRIE ALI
SPA

R65040260:

MARENO

INDUSTRIE ALI
SPA

R65040260:

LAINOX ALI SPA

LAR65040260:

LAINOX ALI SPA

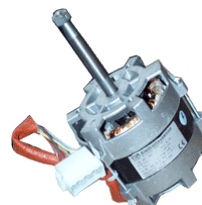

1103396 MOTORE
VENT.FEC060
1075.3163 /
FAN MOTOR FEC060
1075.3162

168843: MBM

RTFOC00011EX:

MBM

166843: MBM



1103595 MOTORE
0,37KW 230V /
MOTOR 0,37KW 230V

168844:

MBM- EUROTEC SRL
- DIV. COOKING
SERVICE

176014:

MBM- EUROTEC SRL
- DIV. COOKING
SERVICE



1103555 MOTORE
FORNO 0,2KW 230V
50HZ /
MOTOR FOR OVEN



1103940 MOTORE
VENTILATORE
230/400V 0,37KW 1020
/

FAN MOTOR
230/400V 0,37KW 1020

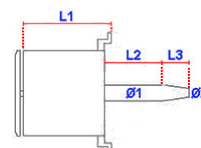

L2=62mm, L3=27mm,
Ø1=17mm, Ø2=12mm,
L1=150mm

1103941 MOTORE
VENTILATORE 200-
240/415V 0,15/0,55KW
2 VELOCITA' 3042 /
FAN MOTOR 200-
240/415V 0,15/0,55KW
2 SPEED 3042

R65040520:
LAINOX ALI SPA

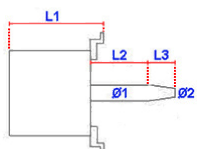

L2=53mm, L3=40mm,
Ø1=24mm, Ø2=20mm,
L1=150mm

S.P.A.

1103819 "MOTORE;
4/6POLI 190W 230V" /
"MOTOR, 4/6 POLES
230 V-190W"

002698:
ELECTROLUX
PROFESSIONAL
S.P.A.



1103942 MOTORE
VENTILATORE 230V
0,37KW 1021 /
FAN MOTOR 230V
0,37KW 1021



1103525 MOTORE
AS.3PH FB80
HP1,0/0,3 V380 /
MOTOR AS.3PH FB80
HP1,0/0,3 V380

6033145: GIORIK
SPA



1103615 MOTORE
FORNO 0.55KW 4
POLI FM /
OVEN MOTOR
0.55KW 4 POLES FM

32M6722:
ANGELO PO
GRANDI CUCINE
SPA



1103473 KIT
MOTORE HP 1 F3 P4
200-480V /
MOTOR HP 1 F3 P4
200-480V

R65040061:
LAINOX ALI SPA
LAR65040061:
LAINOX ALI SPA



1103889 MOTORE
PER FORNO VFB80
4/8P 0.55/0.11Kw 400V
50Hz /
MOTOR VFB80 4/8
0.55/0.11Kw 400V
50Hz

32M6802:
ANGELO PO
GRANDI CUCINE
SPA



FAN=3109224

1103635 MOTORE
VENT.FEC100M8035E
31761 /
FAN MOTOR
FEC100M8035E31761

RTFOC00066:
MBM- EUROTEC SRL
- DIV. COOKING
SERVICE
RIC0004598:
MBM- EUROTEC SRL
- DIV. COOKING
SERVICE



1103758 "MOTORE;
190W 230V 50/60HZ
4/6POLI" /
"MOTOR, 190W 230V
50/60HZ 4/6 POLES"

006998:
ELECTROLUX
PROFESSIONAL
S.P.A.



1103755 MOTORE
FORNO THYRODE /
MOTOR OVEN
THYRODE 304 267



1103787 MOTORE /
MOTOR

005750:
ELECTROLUX
PROFESSIONAL
S.P.A.



1103706 MOTORE
3042D2350
KW0,55/0,15 230V /
MOTOR 3042D2350
KW0,55/0,15 230V

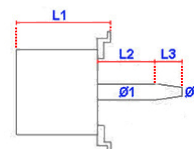

L2=54mm, L3=48mm,
Ø1=24mm, Ø2=20mm,
L1=150mm

1103806 "MOTORE
FORNO 190W 230V 1P
50/60HZ" /
"MOTOR OVEN 190W
230V 50/60HZ 1P"

0F0007:
ELECTROLUX
PROFESSIONAL



3109014 MOTOVEN
TILATORE 054842 /
FAN MOTOR
054842*:
ELECTROLUX
PROFESSIONAL
S.P.A.



1103395 KIT
TRASFORMAZIONE
MOTORE LAINOX /
MOTOR KIT LAINOX
R65490710:
LAINOX ALI SPA
LAR65490710:
LAINOX ALI SPA

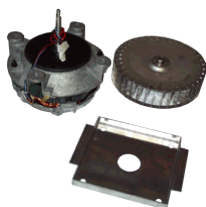

1103397 MOTORE
MONOFASE /
MONOPHASE
MOTOR
R65041000:
LAINOX ALI SPA
*:
GARBIN
INDUSTRIES SRL
LAR65041000ex:
LAINOX ALI SPA
LAR65041010:
LAINOX ALI SPA

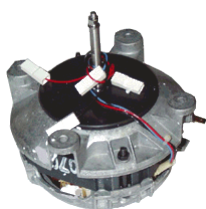

1103885 MOTORE
FORNO MONOFASE
P1-0,18KW P2-0,12KW
/
MONOPHASE
MOTOR FOR OVEN
P1-0,18KW P2-0,12
KW
MOTO17:
GARBIN
INDUSTRIES SRL



1103727 MOTORE
1F HP0,25 /
MOTOR 1F HP0,25
6032116: GIORIK
SPA



1103907 MOTORE
VENTILATORE
0,12KW 230V 50/60Hz
/
FAN MOTOR 0,12KW
230V 50/60Hz



1103548 MOTORE
VENTILATORE 230V
0,12KW 50HZ /
FAN MOTOR 230V
0,12KW 50HZ



1103407 MOTORE
PER FORNI /
MOTOR FOR OVEN



1103399 MOTORE
SPREMIAGRUMI S98
/ MOTOR FOR S98
30104: CEADO SRL



1103411 MOTORE
SPREMIAGRUMI
SL98 /
MOTOR FOR SL 98
30102: CEADO SRL



1103899 MOTORE
230V 1PH /
MOTOR 230C 1hp
CE605503:
FIMAR S.P.A.



1103830 MOTORE
FRULLAT. P105 235 /
BLENDER MOTOR
P105 235
C00061225:
MACAP SRL



1103922 MOTORE
FRULLAT. 800 W 230
V /
MOTOR FOR MIXER
800W
C00061224:
MACAP SRL



1103863 MOTORE
ROBOUT COUPE /
MOTOR FOR
ROBOUT COUPE



1103757 MOTORE
COMPL.FRULLINO
235 /
COMPLETE ENGINE
235 BEATER
C00061218:
MACAP SRL



1103326 MOTORE
230V M56 CB /
MOTOR 230V M56 CB
GE-GS 48/96: CB
SRL



1103284 MOTORE
0,24KW T71 /
MOTOR 0,24KW T71
32M3820:
ANGELO PO
GRANDI CUCINE
SPA



L2=40mm, L3=19mm,
Ø1=10mm,
Ø2=7X8mm, L1=90mm

1103768 MOTORE
.KW.0,09+FR.V.230/40
0/50/60 /
MOTOR KW.0,09 +
FR.V.230/400/50/60
ES06600:
OEM ALI SPA

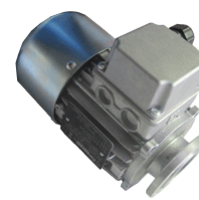

1103802 MOTORE
PL30 KW.1,1
230/400/3/50 V /
MOTOR PL30 KW.1,1
230/400/3/50 V
50DAA73880:
OEM ALI SPA



1103769 MOTORE
M71 KW.0,37
V230/400 50/60 /
MOTOR M71 KW.0,37
V230 / 400 50/60
ES00800:
OEM ALI SPA



1103724 MOT.MA9
0 KW.0,56
V230/400T+1T /
MOTOR MA90
KW.0,56
V230/400T+1T
ES16800:
OEM ALI SPA



1103923 MOT.KW.0
,09
V.230M/50+FRENO+1
T /
MOTOR KW.0,09
V.230M/50+BRAKE+1
T
ES08900:
OEM ALI SPA



1103242 MOTORE
0,045KW O,0765 /
MOTOR 0,045KW
O,0765
32M4301:
ANGELO PO
GRANDI CUCINE
SPA

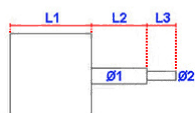

L2=40mm, L3=19mm,
Ø1=10mm,
Ø2=7X8mm,
L1=90mm

1103780 MOTORE
220V L35E OMAS /
OMAS MOTOR 220V
L35E



1103311 MOTORE
B113/4TBW 230/400V
IP44 /
MOTOR B113/4TBW
230/400V IP44



1103856 VENTILAT
ORE TANGENZIALE
180-15 DX /
TANGENTIAL FAN
180-15 DX



HEATING
ELEMENT=1101833

1103325 MOTORE
380V M56 B4 CB /
MOTOR 380V M56 B4
CB
GP-GV: CB SRL



1103857 VENTILAT
ORE TANGENZIALE
180-15 SX /
TANGENTIAL FAN
180-15 SX



HEATING
ELEMENT=1101833

1103858 VENTILAT
ORE TANGENZIALE
DOPPIO 180+180 -20 /
DOUBLE
TANGENTIAL FAN
180 + 180 -20
3526028: L



HEATING
ELEMENT=1101833

1103328 VENTILAT
ORE TANGENZIALE
CB /
TANGENTIAL
MOTOR CB
VR-EV-ESP/2:
CB SRL



1103759 "POMPA;
230-240V 50-60HZ;
UL" / PUMP, 230-240V
50-60HZ, UL"
OC9067:
ELECTROLUX
PROFESSIONAL
S.P.A.
OC8347EX:
ELECTROLUX
PROFESSIONAL
S.P.A.
OCA120:
ELECTROLUX
PROFESSIONAL
S.P.A.



1103655 MOTORE
CAPPA ASPIRANTE /
MOTOR EXTRACTOR
HOOD
MOTO0068:
DR. ZANOLLI S.R.L.



1103774 POMPA
VIBRAZIONE 48W
230V CNTT-OTN /
VIBRATION PUMP
48W 230V



1103838 ASPIRATO
RE VMN
402+M.0,25KW
SENZA
REGOLAZIONE DI
VELOCITA' /
EXHAUSTER 402
VMN + M.0,25KW
WITHOUT SETTING
SPEED
ES33000:
OEM ALI SPA



1103912 VENTOLA
CV 5 50HZ /
IMPELLER CV 5 50HZ
293200680: GICO
SPA

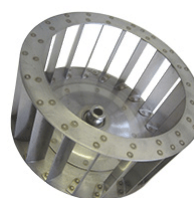

1103331 MOTORE
GYROS GAS
COMPLETO CB /
COMPLETE GAS
GYROS MOTOR CB
GYROS GAS: CB SRL



1103878 VENTOLA
DIAMETRO 250X120
H (26 ALETTE) /
IMPELLER
DIAMETER 250 X 120
H (26 FINS
C2430-11K :
INOXTREND S.R.L.



1103839 VARIATO
RE /
VARIATOR
ES2300: OEM ALI
SPA



1103556 VENTOLA
FORNO SUPERIORE /
FAN FOR OVEN



1103929 GRUPPO
MOTORE+CUFFIA
RIDUTTORE
EXPORT20 RISP.
ENERG. V230-400/50-
60/3 TRIFASE, C/OLIO
P/RIDUTTORE /
GEARMOTOR
3416718:
ING. ROMEO
AGUSTONI SRL



1103743 VENTILAT
ORE PER VALVOLA
GAS /
FAN FOR GAS
VALVE
R63130010:
LAINOX ALI SPA
LAR63130010:
LAINOX ALI SPA



1103864 VENTILAT
ORE PANNELLO
COMANDI
80X80X38MM /
FAN CONTROL
PANEL 80X80X38MM
77045:

ELETTROBAR
DIVISIONE DELLA
EUROTEC SRL



DIMENSIONS
80 X 80 X 38 MM

1103686 VENTILAT
ORE ASSIALE
80X80X25
CUSCINETTI /
AXIAL FAN
80X80X25

05BA0012002:
SPM DRINK
SYSTEMS SPA
006125:
ELECTROLUX
PROFESSIONAL
S.P.A.



1103726 VENTOLA
24VDC 92X92X25
F.TUNN. /
FAN 24VDC
92X92X25
ES27800:
OEM ALI SPA



1103811 FILTRO X
VENTILATORE.120X1
20X38(ES227 /
FAN FILTER X
120X120X38
ES30900:
OEM ALI SPA



1103685 VENTILAT
ORE ASSIALE
120X120X25MM
CUSCINETTI /
AXIAL FAN
120X120X25MM



1103832 VENTILAT
ORE PROTETTO
INOX 1V+DISC.PROT.
/
Fan PROTECTED
STAINLESS 1V +
DISC.PROT
32M6610:
ANGELO PO
GRANDI CUCINE
SPA



1103687 VENTILAT
ORE ASSIALE
120X120X38MM
CUSCINETTI /
AXIAL FAN
120X120X38MM
3380006900:
UGOLINI SPA
1648110107:
POLARIS/BARON
ALI S.P.A.
10724:
FOINOX S.P.A.
ES39100:
OEM ALI SPA
OC4106:

ELECTROLUX
PROFESSIONAL
S.P.A.

BN3102350:
OLIS DIVISIONE
DI ALI GROUP SPA
LAR65060050:
LAINOX ALI SPA



3109008 VENTOLA
D. 160 31TC A.PO /
FAN D. 160 31TC A.
PO
32M0370:
ANGELO PO
GRANDI CUCINE
SPA

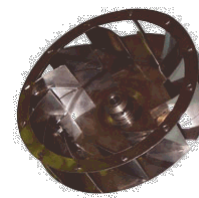

Ø=160mm

3109224 VENTOLA
RADIALE §365 /
FAN - D. 365mm
32M6761:
ANGELO PO
GRANDI CUCINE
SPA

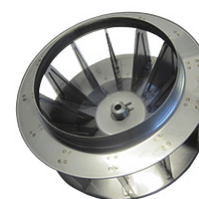

=1103889

1103466 VENTILAT
ORE FORNO
ZANUSSI 0C4423 /
OVEN FAN ZANUSSI
0C4423
OC4423:
ELECTROLUX
PROFESSIONAL
S.P.A.



3109206 "VENTOL
A; DIA 350X135 MM" /
FAN OVEN 350X135
MM DIAMETER
054890:
ELECTROLUX
PROFESSIONAL
S.P.A.



Ø=350mm

3109214 VENTOLA
/ FAN
VEN000:
GARBIN
INDUSTRIES SRL



1103912 VENTOLA
CV 5 50HZ /
IMPELLER CV 5 50HZ
293200680:
GICO SPA

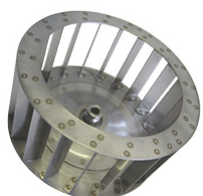

1103878 VENTOLA
DIAMETRO 250X120
H (26 ALETTE) /
IMPELLER
DIAMETER 250 X 120
H (26 FINS
C2430-11K :
INOXTREND S.R.L.

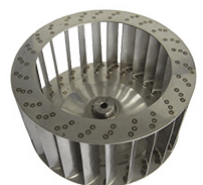

3109147 VENTOLA
D.220mm /
FAN D.220mm
R75400230:
LAINOX ALI SPA
LAR75400230:
LAINOX ALI SPA
LAR75400230:
SILKO ALI SPA



Ø=220mm

3109226 GIRANTE
X
MOTOASPIRATORE
(ES288) /
FAN (ES288)
ES348R0:
OEM ALI SPA



H=77mm, Ø=133mm

1103556 VENTOLA
FORNO SUPERIORE /
FAN FOR OVEN



2103002 GUARNIZI
ONE PORTA FCV61 A.
PO /
COMBI OVEN DOOR
GASKET FCV61 A.PO
37Q0952:
ANGELO PO
GRANDI CUCINE
SPA

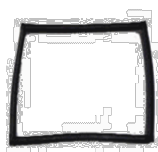

2103012 GUARNIZI
ONE PORTA FORNO
A. PO /
OVEN DOOR
GASKET A.PO
37Q0970:
ANGELO PO
GRANDI CUCINE
SPA
37Q0972:
ANGELO PO
GRANDI CUCINE
SPA



2103264 GUARNIZI
ONE FACCIATA
695X485mm /
OVEN GASKET
695X485mm
36E3021:
ANGELO PO
GRANDI CUCINE
SPA

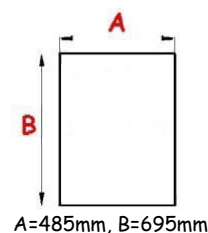

A=485mm, B=695mm

2103003 GUARNIZI
ONE FORNO FCV61
A. PO /
COMBI OVEN
GASKET FCV61 A.PO
37Q2982:
ANGELO PO
GRANDI CUCINE
SPA

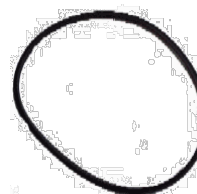

2103013 GUARNIZI
ONE PORTA FORNO
A. PO /
OVEN DOOR
GASKET A.PO
37Q2992:
ANGELO PO
GRANDI CUCINE
SPA



2103705 GUARNIZI
ONE FORNO AL
METRO /
OVEN GASKET SOLD
PER METER
3031880:
ANGELO PO
GRANDI CUCINE
SPA



DIMENSIONS
14X8mm

2103111 GUARNIZI
ONE /
GASKET
3150900:
ANGELO PO
GRANDI CUCINE
SPA



2103076 GUARNIZI
ONE FORNO A. PO
37Q3220 /
OVEN GASKET A.PO
37Q3220
37Q3220:
ANGELO PO
GRANDI CUCINE
SPA



2103140 GUARNIZI
ONE PORTA FORNO
320X420mm /
GASKET OVEN
DOOR 320X420mm
05020016: CB SRL

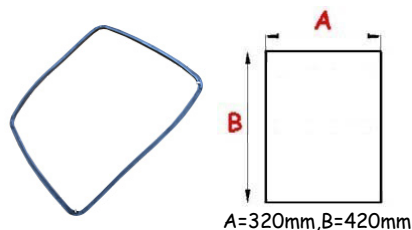

2103135 GUARNIZI
ONE PORTA FORNO
GOLOSO /
OVEN DOOR
GASKET GOLOSO
GOLOSO: CB SRL



2103577 GUARNIZI
ONE PORTA FORNO
CONVOTHERM
458X506mm /
OVEN DOOR
GASKET 458X506 mm

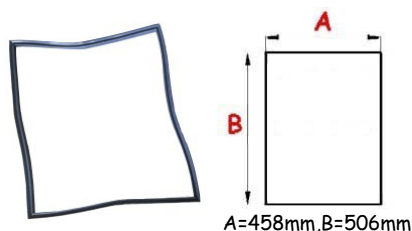

2103219 GUARNIZI
ONE VETRO FORNO
COVEN TEC6 /
GLASS GASKET FOR
OVEN COVEN TEC6

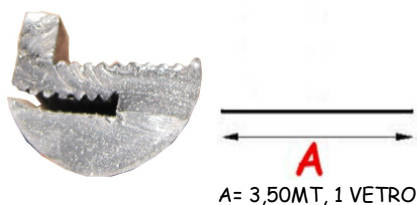

2103467 GUARNIZI
ONE PORTA FORNO
COVEN /
OVEN DOOR SEAL
COVEN



2103631 "GUARNIZI
IONE PORTA;
475X450MM" /
OVEN DOOR
GASKET 500x480 mm
0C1496:
ELECTROLUX
PROFESSIONAL
S.P.A.

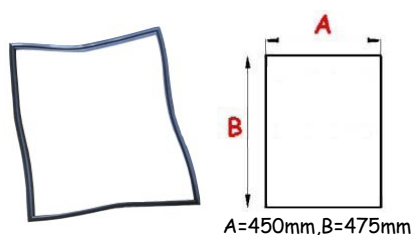

2103434 "GUARNIZI
IONE FORNO;
725X450MM" /
SEAL OVEN;
725X450MM
007069EX:
ELECTROLUX
PROFESSIONAL
S.P.A.
0C1477:
ELECTROLUX
PROFESSIONAL
S.P.A.

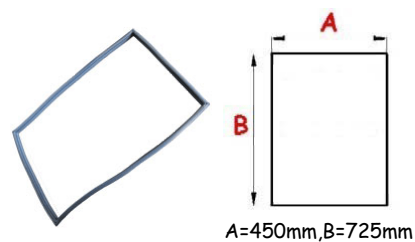

2103009 GUARNIZI
ONE PORTA FORNO
10GN 55315
640X720mm /
OVEN DOOR
GASKET 10GN 55315
640X720mm
055315:
ELECTROLUX
PROFESSIONAL
S.P.A.

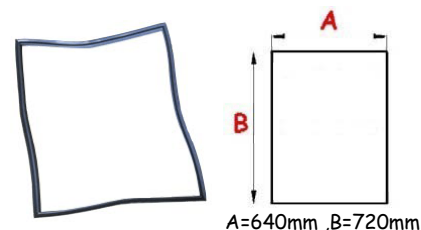

2103671 "GUARNIZI
IONE PORTA;
INFERIORE; L=807
MM" /
LOWER DOOR
GASKET
0C4131:
ELECTROLUX
PROFESSIONAL
S.P.A.



2103186 GUARNIZI
ONE /
GASKET
002745:
ELECTROLUX
PROFESSIONAL
S.P.A.

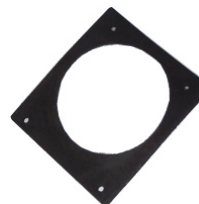

2103220 GUARNIZI
ONE PORTA FORNO
TEC6 /
DOOR GASKET FOR
OVEN TEC6
9629918:
EMMEPI GRANDI
CUCINE S.R.L.



2103482 GUARNIZI
ONE PORTA FORNO
DAGA 700X700 /
OVEN DOOR SEAL
DAGA 700X700
C10090:
EMMEPI GRANDI
CUCINE S.R.L.

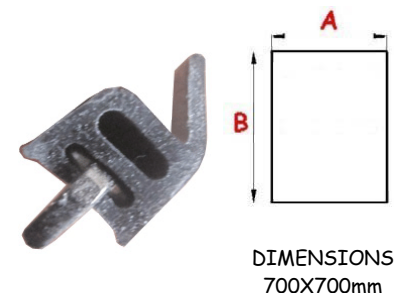

S&P Cooking Catalogue 2017

2103666 GUARNIZI
ONE FORNO FOINOX
FM200EPPA /
GASKET FOR OVEN
DOOR FOINOX
FM200EPPA

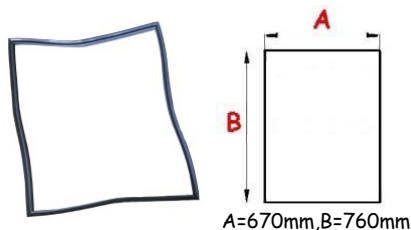

2103696 GUARNIZI
ONE PORTA /
DOOR GASKET



2103595 GUARNIZI
ONE PORTA
BLUPASTRY /
GASKET DOOR
BLUPASTRY



2103624 GUARNIZI
ONE PORTA FORNO /
OVEN DOOR
GASKET



2103706 GUARNIZI
ONE PORTA FORNO
685X385mm /
OVEN DOOR
GASKET 685X385mm
GUA222:
GARBIN
INDUSTRIES SRL
GUA006:
GARBIN
INDUSTRIES SRL

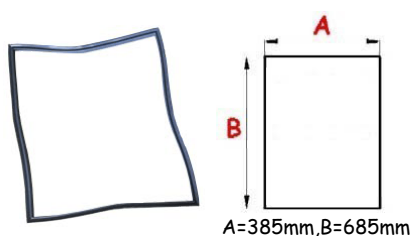

2103245 GUARNIZI
ONE PORTA FORNO /
OVEN DOOR
GASKET GARBIN
GUA013:
GARBIN
INDUSTRIES SRL

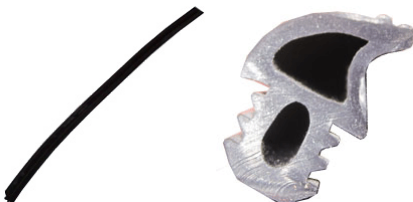

2103593 GUARNIZI
ONE PORTA (TELAIO)
716X706 /
GASKET DOOR
(FRAME) 716X706
7070175: GIORIK
SPA

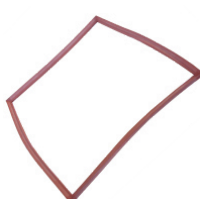

2103115 GUARNIZI
ONE TELAIO PORTA
FORNO FG10 /
DOOR OVEN
GASKET FG10
7070172: GIORIK
SPA

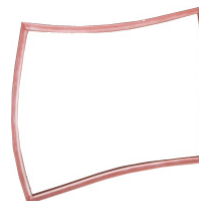

2103114 GUARNIZI
ONE LCS56T NERA X
VETRO /
GASKET LCS56T
7070161: GIORIK
SPA
7070161:
OFFCAR THE GREAT
COOKING S.R.L.



2103209 GUARNIZI
ONE PORTA FORNO /
OVEN DOOR
GASKET
R70041540:
LAINOX ALI SPA
5050950: LAINOX
ALI SPA
LAR70041540:
LAINOX ALI SPA
5066959: L

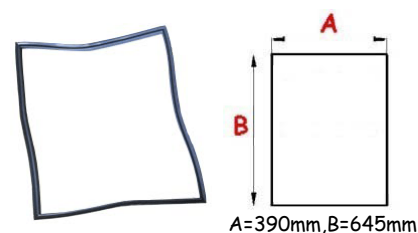

2103553 GUARNIZI
ONE FACCIATA
FORNO 610X435MM /
OVEN GASKET
LAR70044340:
LAINOX ALI SPA
LAR70044340:
SILKO ALI SPA

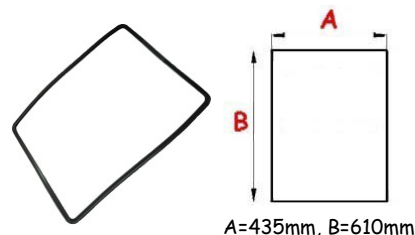

2103646 GUARNIZI
ONE PORTA FORNO
660X500mm /
OVEN DOOR
GASKET 660X500mm
LAR70044540:
LAINOX ALI SPA
LAR70044540:
SILKO ALI SPA

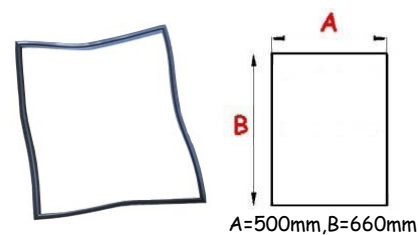

2103366 GUARNIZI
ONE FACCIATA
FORNO /
GASKET FRONT
OVEN
*: LAINOX ALI SPA
LAR70044230:
LAINOX ALI SPA
LAR70044230:
SILKO ALI SPA

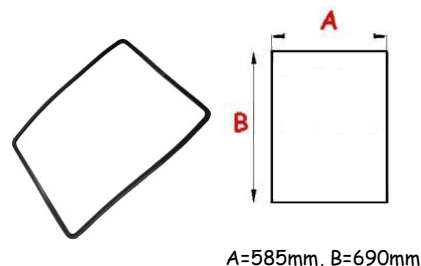

S&P Cooking Catalogue 2017

2103614 GUARNIZI
ONE FORNO LAINOX
RG10 655 mm L 755
mm /
OVEN GASKET
LAINOX RG10 655
mm L 755 mm

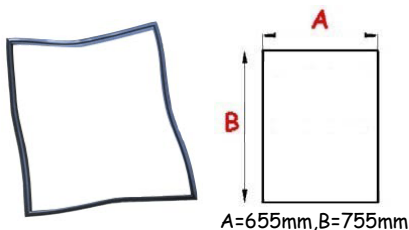

2103672 GUARNIZI
ONE PORTA /
DOOR GASKET
LAR70043110:
LAINOX ALI SPA
LAR70043110:
SILKO ALI SPA



L=2400mm

2103375 GUARNIZI
ONE PORTA /
GASKET DOOR
R70042510:
LAINOX ALI SPA
LAR70042510:
LAINOX ALI SPA
LAR70042510:
SILKO ALI SPA

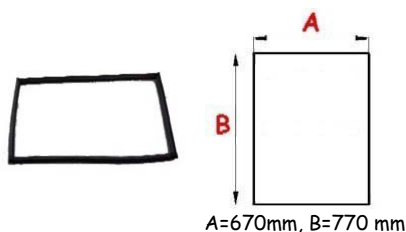

2103300 GUARNIZI
ONE FACCIATA
FORNO /
OVER DOOR GASKET
R70042870ex:
LAINOX ALI SPA
LAR70042870:
LAINOX ALI SPA
LAR70042870:
SILKO ALI SPA

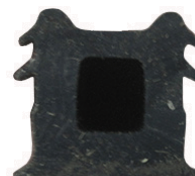

L=2500mm

2103599 GUARNIZI
ONE FACCIATA
FORNO 680X805mm /
OVEN DOOR
GASKET 680X805mm
LAR70044110:
LAINOX ALI SPA
LAR70044110:
SILKO ALI SPA

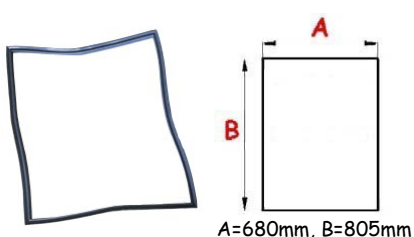

2103263 GUARNIZI
ONE CARRELLO CON
TAMPONAMENTO /
CADDIE GASKET
LAR70044360:
SILKO ALI SPA
LAR70044360:
LAINOX ALI SPA
R70044360:
LAINOX ALI SPA



2103602 GUARNIZI
ONE FACCIATA
FORNO /
GASKET FRONT
OVEN
LAR70044220:
SILKO ALI SPA
LAR70044220:
OLIS DIVISIONE
DI ALI GROUP SPA
-
LAR70044220:
LAINOX ALI SPA

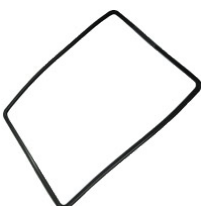

2103650 GUARNIZI
ONE PORTA
MANTENITORE
682X595mm /
GASKET DOOR
maintainer 682X595mm
LAR70044960:
MARENO
A32101100:
MARENO
INDUSTRIE ALI
SPA

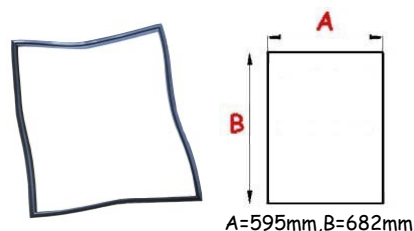

2103372 GUARNIZI
ONE PORTA RG10 /
DOOR GASKET RG10
R70041290:
LAINOX ALI SPA
LAR70041290:
LAINOX ALI SPA



2103035 PROFILO
GUARNIZIONE
PORTA FC6 MARENO
/
DOOR GASKET FC6
MARENO
MA2885900:
MARENO
INDUSTRIE ALI
SPA

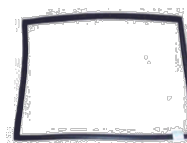

2103029 GUARNIZI
ONE TENUTA
CARRELLO /
OVEN GASKET
R70041150:
LAINOX ALI SPA
LAR70041150:
LAINOX ALI SPA



2103163 GUARNIZ.
P.F.FEC065
GIUNTATA /
GASKET P.F.FEC065
RTFOC00723:
MBM- EUROTEC SRL
- DIV. COOKING
SERVICE

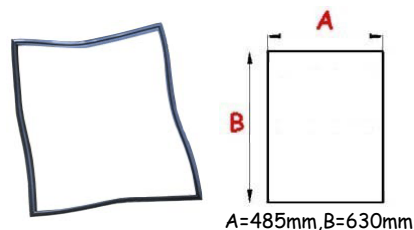

2103077 GUARNIZI
ONE PORTA FORNO
715X685mm /
GASKET OVEN
DOOR 715X685mm

RTFOC00722:

MBM- EUROTEC SRL
- DIV. COOKING
SERVICE

173827:

MBM- EUROTEC SRL
- DIV. COOKING
SERVICE

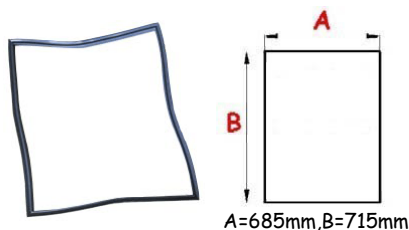

A=685mm, B=715mm

2103435 GUARNIZI
ONE PROFILO
THERMIC - 60/T MTR
SV.52 /

OVEN GASKET
PROFILE THERMIC
60/T MRT SV.52

844491:

OFFCAR THE GREAT
COOKING S.R.L.



2103584 GUARNIZI
ONE SUPERIORE
F.G4SF7 /

UPPER GASKET
G4SF7

164738:

MBM- EUROTEC
SRL - DIV.
COOKING SERVICE



L=596mm

2103217 GUARNIZI
ONE PORTA FORNO
450X540MM /
DOOR SEAL
450X540MM

BN3108600:

OLIS DIVISIONE
DI ALI GROUP SPA

-

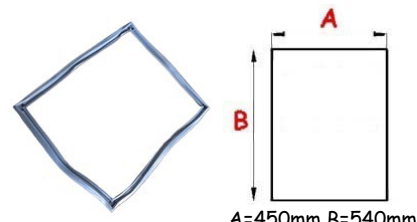

A=450mm, B=540mm

2103155 *GUARNIZ
.P.F.FECFGC200100 /
DOOR GASKET
FECFGC200100

RTFOC00094:

MBM- EUROTEC SRL
- DIV. COOKING
SERVICE

PAFOC00575:

MBM- EUROTEC SRL
- DIV. COOKING
SERVICE

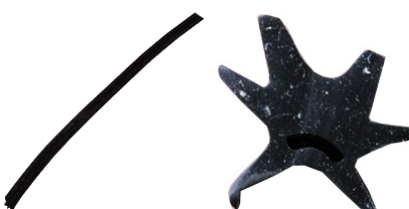

2103281 GUARNIZI
ONE PORTA FORNO
OLIS 640X770MM /
OVEN DOOR
GASKET OLIS
640X770MM

2103281:

OLIS DIVISIONE
DI ALI GROUP SPA

-

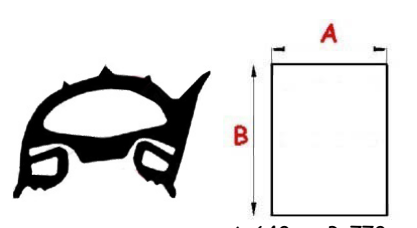

A=640mm, B=770mm

2103464 GUARNIZI
ONE PORTA FORNO
2410 /
OVEN DOOR
GASKET 04880 - 3 m



DIMENSIONS
26X26,4MM

2103053 KIT
GUARNIZIONE
PORTA FORNO
590x305 /
OVEN DOOR
GASKET

RIC0004731:

MBM- EUROTEC SRL
- DIV. COOKING
SERVICE

RTC0800097EX:

MBM- EUROTEC SRL
- DIV. COOKING
SERVICE



2 Guarnizioni con
guida=305mm, 1
Guarnizione con
guida=590mm

2107204 BRONZIN
A FRULLATORE L. 5 /
BUSHING BLENDER
LT5

C0009F305:

MACAP SRL



2107109 BOCCOLA
REGOLAZIONE ARIA
PER BRUCIATORE
TOP MODULAR /
AIR REGULATOR
ROD SLIDE FOR
BURNER TOP
MODULAR

67201600:

MODULAR SPA



2103393 GUARNIZI
ONE FORNO
MODULAR TIPO
NUOVO /
GASKET FOR
MODULAR OVEN
NEW TYPE

65201300:

MODULAR SPA



2107195 BUSSOLA
AUTOL.45E7/55/65X39
+6 /
BUSH
AUTOL.45E7/55/65X39
+6

AE04600:

OEM ALI SPA



2107203 BOCC.PER

NO PORTA
DM+S.2000+GAS /
BUSH PIVOT DOOR
DM + S.2000 + GAS

HKT0100:

OEM ALI SPA

E1K0300:

OEM ALI SPA



2107214 BUSSOLA

AUTOLUBRIFICANTE
20E7/26X15 BM2 /
BUSHING AUTOLUBE
20E7 / 26X15 BM2

AE04500:

OEM ALI SPA



1134016 MOTORID

UTTORE CON
BOCCOLA /
MOTO REDUCER
WITH BUSH

007010053: CB SRL

07010116: CB SRL



1134064 MOTORID

UTTORE 240V<=""
reducer="" moto=""
wurstel="">

CUOCI WUSTEL A

RULLI: CB SRL

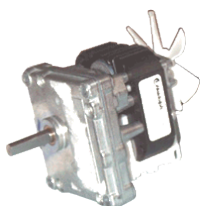

1134028 MOTORID

UTTORE
BRUSCHETTATRICE
5W 2,4 RPM /
BRUSCHETTATRICE
MOTO REDUCER

PR4G033: FABA SRL

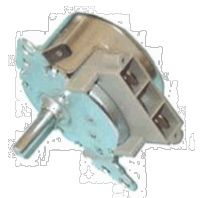

1134024 MOTORIN

O AGITATORE /
MOTO-MIXER

SL3CHML740A:

GBG ALI SPA

SL300006055ex:

GBG ALI SPA

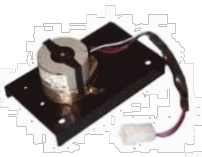

1134104 MOTORID

UTTORE
CIOCCOLATIERA
230V 50HZ /
GEAR MOTOR FOR
CHOCOLATE
MACHINE 230V 50HZ

2209200012:

UGOLINI SPA

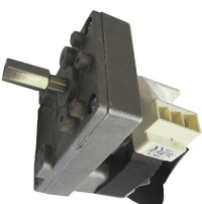

ALBERO Ø 5X20mm,
STAFFA= 4119068

1134110 MOTORID

UTTORE 3-5 LT 230V
50HZ /
GEAR MOTOR 3-5 LT
230V 50HZ

2250002400:

UGOLINI SPA

2250002410:

UGOLINI SPA



ALBERO Ø 5X20mm

1134055 MOTORID

UTTORE PER
SPIRALI MR130 /
MOTO REDUCER
MR130



1134036 MOTORID

UTTORE MR330 H12
1,8rpm ANTIORARIO /
MOTO REDUCER
MR330 H12 1,8rpm
ANTICLOCKWISE



1134039 MOTORID

UTTORE MR330 H20
16WCLH 2 RPM 230V
/
MOTO REDUCER
MR330 H20 16WCLH 2
RPM 230V

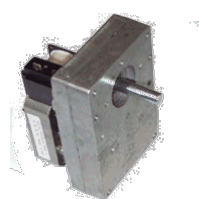

1134041 MOTORID

UTTORE 2RPM
220V/50HZ 16W CLH /
MOTO REDUCER
2RPM 220V/50HZ 16W
CLH



1134044 MOTORID

UTTORE MR330
6RPM 240V /
MOTO REDUCER
MR330 6RPM 240V

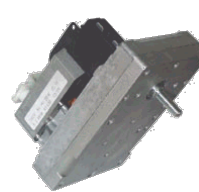

1134048 MOTORID

UTTORE MR 530 H40
39rpm /
MOTO REDUCER MR
530 H40 39rpm

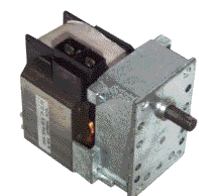

S&P Cooking Catalogue 2017

1134050 MOTORID
UTTORE MR 330 /
MOTO REDUCER MR
330



1134119 Motoridutto
re completo /
complete gearmotor
07010006: **CB SRL**



1134056 MOTORID
UTTORE ASR30V
230V 6RPM /
MOTO REDUCER
ASR30V 230V 6RPM



1134134 MOTORID
UTTORE 230V 50Hz /
GEARMOTOR 230V
50Hz
CO1488: **FIMAR
S.P.A.**



1134081 MOTORID
UTTORE MR 330 H12
0,7 RPM /
MOTOREDCER MR
330 H12 0,7 RPM

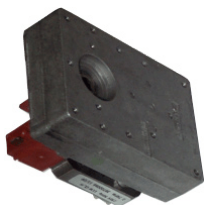

1134130 RIDUTTO
RE MVF 49/FO R.1/60
BM2 /
GEAR MVF 49/FO
R.1/60 BM2
KD02700:
OEM ALI SPA



1134059 MOTORID
UTTORE M56 B4
GIRARROSTI
PLANETARI CB /
MOTO REDUCER M56
B4 CB
GIRARROSTI
PLANETARI E GV:
CB SRL



1134060 RIDUTTO
RE RMI 28/50 CB /
MOTO REDUCER RMI
28/50 CB
GP 20/24/30/36/72:
CB SRL













1134061 RIDUTTO
RE MCF CB /
MOTO REDUCER
MCF CB
GP 48/96: **CB SRL**





1134062 RIDUTTO
RE CRMI 28/40 FP /
MOTO REDUCER
CRMI 28/40 FP
GV: **CB SRL**



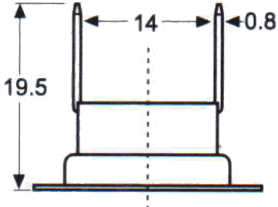
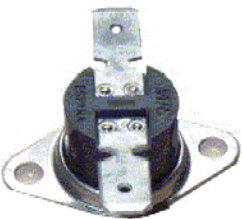
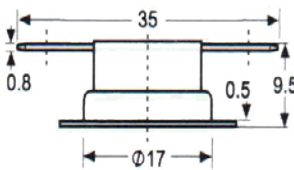

S&P Cooking Catalogue 2017

CODICE S&P S&P CODE		CAPACITA' ELETTRICA μ F CAPACITANCE μ F	ADATTABILITA' ADAPTABILITY
1135008		4 μ F	
1135007		5 μ F	206010: ELETTOBAR DIVISIONE DELLA EUROTEC SRL 631208: COMENDA ALI SPA 00300105: LAMBER DI AFFABA FRANCESCO & C. 3113034: WINTERHALTER ITALIA SRL
1135003		6,3 μ F	631216: COMENDA ALI SPA 0300110: LAMBER DI AFFABA FRANCESCO & C.
1135004		8 μ F	631201: COMENDA ALI SPA 32Z2490: ANGELO PO
1135001		10 μ F	180018: MAGISTER SISTEMA CAFFE' SRL 34020003: RANCILIO SPA 0300106: LAMBER DI AFFABA FRANCESCO & C. R65190180: LAINOX ALI SPA 531401600: CIMBALI
1135002		12,5 μ F	34020004: RANCILIO SPA CECN12: I.M.E. SRL 621207: COMENDA ALI SPA DW1581: DIHR-ALI SPA 047883: ZANUSSI 047541: ZANUSSI
1135006		16 μ F	3400016: RANCILIO SPA 206004: ELETTOBAR DIVISIONE DELLA EUROTEC SRL
1135005		18 μ F	
1135012		20 μ F	206005: ELETTOBAR DIVISIONE DELLA EUROTEC SRL
1135010		25 μ F	

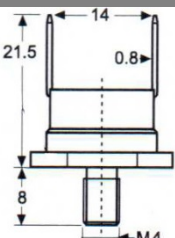
TERMOSTATI A CONTATTO / CONTACT THERMOSTATS

CODICE S&P S&P CODE	TEMPERATURA °C TEMPERATURE °C	SCHEDA TECNICA DATA SHEET	ADATTABILITA' ADAPTABILITY
			
1106237	60°C		LT35-22: ELETTOBAR
1106183	80°C		236048: ELETTOBAR
1106111	90°C		236052: ELETTOBAR
1106148	95°C		34200074: RANCILIO SPA 34200059: RANCILIO SPA
1106316	110°C		34200056: RANCILIO SPA
1106159	115°C		
1106149	130°C		
1106160	140°C		
1106150	155°C		
1106151	160°C		
1106152	165°C		
1106153	170°C		
1106154	175°C		
1106155	180°C		
			
1106289	55°C		L2061: LUXIA SRL
1106047	57°C		907123: SILANOS SRL
1106442	75°C		
1106740	100°C		
1106080	140°C		
			
1106481	95°C		
1106016	100°C		34200074: RANCILIO SPA
1106430	107°C		

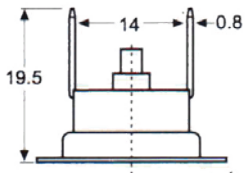
S&P Cooking Catalogue 2017

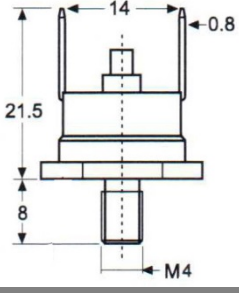
CODICE S&P S&P CODE	TEMPERATURA °C TEMPERATURE °C	SCHEDA TECNICA DATA SHEET	ADATTABILITA' ADAPTABILITY
1106017	135°C		34200075: RANCILIO SPA
1106432	125°C		
1106345	165°C		34200053: RANCILIO SPA
			
1106334	95°C		926189: ELETTOBAR 236047: ELETTOBAR
1106744	100°C		907245: SILANOS SRL
1106364	105°C		0300302: LAMBER
1106182	110°C		236039: ELETTOBAR
1106454	130°C		
			
1106483	145°C		
1106043	165°C		34200058: RANCILIO SPA

TERMOSTATI DI LAVORO MONOFASE / THERMOSTATS SINGLE PHASE

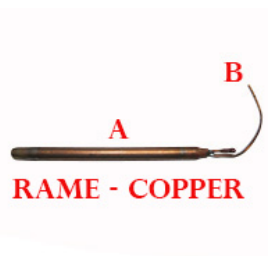

CODICE S&P S&P CODE	TEMPERATURA °C TEMPERATURE °C	N. POLI N. POLES	SCHEDA TECNICA DATA SHEET	CAPILLARE RICOPERTO CAPILLARY COVERED	ADATTABILITA' ADAPTABILITY
1106001	0-90°	3	A=Ø6,5X95mm B=1500mm	SI - YES	907110: SILANOS H120501: HOONVED 1106001: LASA T40-80-00005: VELOX BARCHITTA 808726ex: EMMEPI CETB85: OMNIWASH 34200047: RANCILIO 1106001: S.V. ITALIA 1106001: EURO 2000 1080: A.T.A. UNIVERSAL: ARISTARCO 120501: COMENDA 103345: KRUPPS
1106315	0-120°	3	A=Ø6X83mm B=900mm	NO	T40-80-00006: VELOX BARCHITTA
1106389	30-120°	3	A=Ø6X68mm B=1500mm	SI - YES	SL300099001: GBG
1106093	40-210°	3	A=Ø5X120 mm B=1500mm	SI - YES	

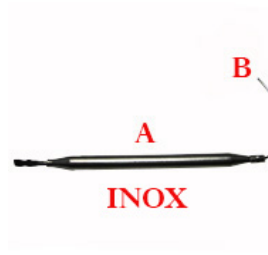

CODICE S&P S&P CODE	TEMPERATURA °C TEMPERATURE °C	N. POLI N. POLES	SCHEDA TECNICA DATA SHEET	CAPILLARE RICOPERTO CAPILLARY COVERED	ADATTABILITA' ADAPTABILITY
1106186	0-195°	3	A=Ø5X100 mm B=1500mm	NO	

TERMOSTATI DI LAVORO MONOFASE / THERMOSTATS SINGLE PHASE

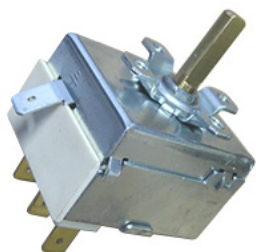

CODICE S&P S&P CODE	TEMPERATURA °C TEMPERATURE °C	N. POLI N.POLES	SCHEDA TECNICA DATA SHEET	CAPILLARE RICOPERTO CAPILLARY COVERED	ADATTABILITA' ADAPTABILITY
1106106	50-300°	3	A=Ø4X195mm B=1000mm	NO	Z300E003:S.V. ITALIA



CODICE S&P S&P CODE	TEMPERATURA °C TEMPERATURE °C	N. POLI N.POLES	SCHEDA TECNICA DATA SHEET	CAPILLARE RICOPERTO CAPILLARY COVERED	ADATTABILITA' ADAPTABILITY
1106010	90°	3	A=Ø6,5X95mm B=1500mm	SI - YES	22180004: ELFRAMO 0300005: LAMBER DW10707/1:DIHR 120530: COMENDA 907120: SILANOS AL03, AL05, AL10, AL26, AL54, AL55, AL40, AL46:A.T.A. 929107: ELETTOBAR UNIVERSALE:ARISTARCO 14197: FABAR

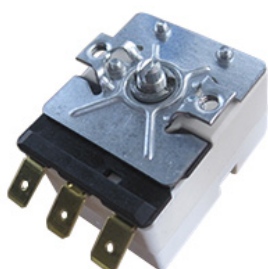

CODICE S&P S&P CODE	TEMPERATURA °C TEMPERATURE °C	N. POLI N.POLES	SCHEDA TECNICA DATA SHEET	CAPILLARE RICOPERTO CAPILLARY COVERED	ADATTABILITA' ADAPTABILITY
1106399	30-90°	3	A=Ø6X114mm B=880mm	SI - YES	0L1633, 068582, 068012: ELECTROLUX

TERMOSTATI DI SICUREZZA MONOFASE / SAFETY THERMOSTATS SINGLE PHASE



CODICE S&P S&P CODE	TEMPERATURA °C TEMPERATURE °C	N. POLI N.POLES	SCHEDA TECNICA DATA SHEET	CAPILLARE RICOPERTO CAPILLARY COVERED	ADATTABILITA' ADAPTABILITY
1106029	110°	3	A=Ø5,5X130mm B=1000mm	NO	120519*:COMENDA 13121*: A.T.A.
1106037	50-110°	2	A=Ø6,5X95 mm B=1000mm	NO	H120519:HOONVED 3267100: LASA 120519: COMENDA 13121: A.T.A. 141197A: FABAR 907125: SILANOS
1106185	95-135°	3	A=Ø5,5X130mm B=1000mm	SI - YES	



CODICE S&P S&P CODE	TEMPERATURA °C TEMPERATURE °C	N. POLI N.POLES	SCHEDA TECNICA DATA SHEET	CAPILLARE RICOPERTO CAPILLARY COVERED	ADATTABILITA' ADAPTABILITY
1106695	320°	2	A=Ø3X180mm B=1400mm C=M9X1	NO	TER008:GARBIN

TERMOSTATI DI SICUREZZA MONOFASE / SAFETY THERMOSTATS SINGLE PHASE



CODICE S&P S&P CODE	TEMPERATURA °C TEMPERATURE °C	N. POLI N. POLES	SCHEDA TECNICA DATA SHEET	CAPILLARE RICOPERTO CAPILLARY COVERED	ADATTABILITA' ADAPTABILITY
1106377	230°	2	A=Ø3X155mm B=890mm	SI - YES	



CODICE S&P S&P CODE	TEMPERATURA °C TEMPERATURE °C	N. POLI N. POLES	SCHEDA TECNICA DATA SHEET	CAPILLARE RICOPERTO CAPILLARY COVERED	ADATTABILITA' ADAPTABILITY
1106691	120°	2	A=Ø6,5X93mm B=1500mm	SI - YES	
1106234	130°	2	A=Ø6X60mm B=500mm	SI - YES	9041052:HEMERSON 984115000:GRUPPO CIMBALI



CODICE S&P S&P CODE	TEMPERATURA °C TEMPERATURE °C	N. POLI N. POLES	SCHEDA TECNICA DATA SHEET	CAPILLARE RICOPERTO CAPILLARY COVERED	ADATTABILITA' ADAPTABILITY
1106431	124°	3	A=Ø4x70mm B=900mm	SI - YES	20198EX: ADLER 20673: FABAR

TERMOSTATI DI SICUREZZA MONOFASE / SAFETY THERMOSTATS SINGLE PHASE



CODICE S&P S&P CODE	TEMPERATURA °C TEMPERATURE °C	N. POLI N.POLES	SCHEDA TECNICA DATA SHEET	CAPILLARE RICOPERTO CAPILLARY COVERED	ADATTABILITA' ADAPTABILITY
1106244	108°	4	A=1000mm	NO	STA-GOLOSO4-PIZZA CB- FP-BAKE/CHEF:CB
1106247	108°	4	A=1000mm	NO	FP OLD MODEL:CB

TERMOSTATI DI LAVORO MONOFASE / THERMOSTATS SINGLE PHASE



CODICE S&P S&P CODE	TEMPERATURA °C TEMPERATURE °C	N. POLI N.POLES	SCHEDA TECNICA DATA SHEET	CAPILLARE RICOPERTO CAPILLARY COVERED	ADATTABILITA' ADAPTABILITY
1106303	30-90°	2	A=Ø6X130mm B=2000mm	SI - YES	BN6A046050:OLIS
1106110	30-90°	2	A=Ø11X135mm B=1000mm		PRF0020: FABA
1106260	30-90°	3	A=Ø6X130mm B=1500mm	NO	MA7800300:MARENO
1106242	0-110°	2	A=Ø6X130mm B=900mm	SI - YES	ECV/SELF: CB
1106378	30-110°	3	A=Ø6X13 mm B=1000mm	NO	
1106273	135°	2	A=Ø6X75mm B=1500mm	SI - YES	
1106736	0-150°	2	A=Ø3X145mm B=1600mm	SI - YES	BN6A001414: OLIS E10600: GIGA
1106706	45-170°	2	A=Ø3X220mm B=900mm	SI - YES	031480:ELECTROLUX
1106441	100-180°	2	A=Ø4X213mm B=900mm	SI - YES	ED04800:OEM
1106357	55-180°	2	A=Ø4X90 mm B=1500mm	NO	00030507:ELFRAMO

S&P Cooking Catalogue 2017

CODICE S&P S&P CODE	TEMPERATURA °C TEMPERATURE °C	N. POLI N. POLES	SCHEDA TECNICA DATA SHEET	CAPILLARE RICOPERTO CAPILLARY COVERED	ADATTABILITA' ADAPTABILITY
1106014	90-185°	2	A=Ø4X240mm B=1300mm	SI - YES	050412:ELECTROLUX
1106058	50-190°	2	A=Ø6X90mm B=490mm	SI - YES	22140004:ELFRAMO PR70009: FABA 33065700:BERTO'S
1106361	60-200°	3	A=Ø6X78mm B=800mm	NO	
1106347	60-200°	3	A=Ø6X75mm B=1000mm	NO	
1106363	50-250°	2	A=Ø3X180mm B=800mm	NO	
1106239	0-250°	3	A=Ø6X69mm B=900mm	SI - YES	GIRARROSTI VENTILATI MANUALI: CB
1106243	0-280°	2	A=Ø3,1X226mm B=870mm	SI - YES	WUSTER T-GOLOSO 4-BAKE/CHEF: CB
1106348	50-296°	2	A=Ø3,1X226mm B=980mm	SI - YES	056384:ELECTROLUX
1106057	0-300°	2	A=Ø3X190mm B=1000mm	NO	PR10009: FABA R65070210-503043: LAINOX 0101382:SILKO X43600:GIGA GRANDI CUCINE DW9010:DIHR MA1037102300:MARENO 69000646:RANCILIO 924024:ELETTROBAR 3529: FOINOX 23063600:BERTO'S
1106445	50-320°		A=Ø3X219mm B=900mm	NO	
1106699	55-320°	2	A=Ø3X230mm B=1000mm	SI - YES	RTCU700085:EUROTEC
1106461	20-358°	2	A=Ø3X178mm B=870mm	NO	
1106719	50-400°	3	A=Ø4X230mm B=900mm	SI - YES	ED05800: OEM
1106446	60-400°	2	A=Ø3X150mm B=600mm	NO	ED10300:OEM
1106107	0-450°	2	A=Ø4X230mm B=1000mm	SI - YES	PR13012: FABA
1106265	50-500°	2	A=Ø4X230mm B=900mm	NO	

TERMOSTATI DI LAVORO MONOFASE / THERMOSTATS SINGLE PHASE

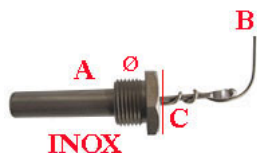

CODICE S&P S&P CODE	TEMPERATURA °C TEMPERATURE °C	N. POLI N. POLES	SCHEDA TECNICA DATA SHEET	CAPILLARE RICOPERTO CAPILLARY COVERED	ADATTABILITA' ADAPTABILITY
1106048	70-170°	2	A=Ø14X25mm B=800mm C=25mm	SI - YES	



CODICE S&P S&P CODE	TEMPERATURA °C TEMPERATURE °C	N. POLI N. POLES	SCHEDA TECNICA DATA SHEET	CAPILLARE RICOPERTO CAPILLARY COVERED	ADATTABILITA' ADAPTABILITY
1106337	30-90°	3	A=Ø6X130mm B=2500mm C=M10X1	NO	32Z0160:ANGELO PO
1106386	30-90°	2	A=Ø6X130mm B=890mm C=M9X1	SI - YES	537001500 LOTUS 10140,0101403, SIR0101403: SILKO
1106748	85-170°	2	A=Ø4X231mm B=900mm C=9X1	SI - YES	
1106007	180°	2	A=Ø6,5X135mm B=1000mm C=M9X1	SI - YES	MA1981900:MARENO
1106259	90-180°	2	A=Ø6X130mm B=900mm C=M9X1	NO	
1106051	100-180°	2	A=Ø6,5X135mm B=1000mm C=M9X1	SI - YES	22140004*:ELFRAMO
1106405	182°	2	A=Ø6X130mm B=900mm C=M9X1	SI - YES	537037700:LOTUS
1106295	185°	2	A=Ø6,5X135mm B=1000mm C=M9X1	SI - YES	161791:ELETTROBAR RTC0700609ex:EUROTEC

S&P Cooking Catalogue 2017

CODICE S&P S&P CODE	TEMPERATURA °C TEMPERATURE °C	N. POLI N. POLES	SCHEDA TECNICA DATA SHEET	CAPILLARE RICOPERTO CAPILLARY COVERED	ADATTABILITA' ADAPTABILITY
1106397	187°	2	A=Ø6X130mm B=1000mm C=M10X1	SI - YES	3168460:ANGELO PO
1106013	100-190°	2	A=Ø6X133mm B=870mm C=M9X1	NO	MA1450914: MARENO
1106392	100-190°	2	A=Ø6,5X130mm B=1800mm C=M9X1	SI - YES	
1106729	105-190°	2	A=Ø4X235mm B=1500mm C=M10X1	SI - YES	22140003ex, 22140004: ELFRAMO
1106261	50-250°	3	A=Ø3,1X226mm B=1150mm C=M9X1	NO	



CODICE S&P S&P CODE	TEMPERATURA °C TEMPERATURE °C	N. POLI N. POLES	SCHEDA TECNICA DATA SHEET	CAPILLARE RICOPERTO CAPILLARY COVERED	ADATTABILITA' ADAPTABILITY
1106023	50-250°	2	A=Ø3X228mm B=1250mm C=16,5mm D=M8X1	SI - YES	32Z5820: ANGELO PO



CODICE S&P S&P CODE	TEMPERATURA °C TEMPERATURE °C	N. POLI N. POLES	SCHEDA TECNICA DATA SHEET	CAPILLARE RICOPERTO CAPILLARY COVERED	ADATTABILITA' ADAPTABILITY
1106181	150°	2	A=Ø6X74mm B=900mm	SI-YES	32Z9380:ANGELO PO

THERMOSTATS SINGLE PHASE / THERMOSTATS SINGLE PHASE

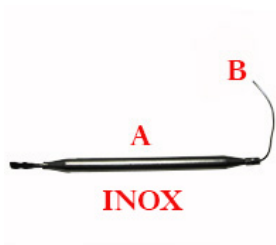

CODICE S&P S&P CODE	TEMPERATURA °C TEMPERATURE °C	N. POLI N. POLES	SCHEDA TECNICA DATA SHEET	CAPILLARE RICOPERTO CAPILLARY COVERED	ADATTABILITA' ADAPTABILITY
1106689	50-170°	2	A=Ø6X75 mm B=400mm	SI-YES	

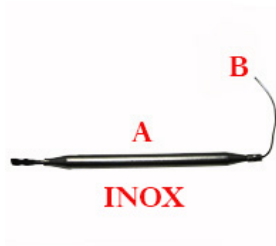

CODICE S&P S&P CODE	TEMPERATURA °C TEMPERATURE °C	N. POLI N. POLES	SCHEDA TECNICA DATA SHEET	CAPILLARE RICOPERTO CAPILLARY COVERED	ADATTABILITA' ADAPTABILITY
1106319	30-205°	2	A=Ø6X77mm B=870mm	NO	



CODICE S&P S&P CODE	TEMPERATURA °C TEMPERATURE °C	N. POLI N. POLES	SCHEDA TECNICA DATA SHEET	CAPILLARE RICOPERTO CAPILLARY COVERED	ADATTABILITA' ADAPTABILITY
1106321	60-215°	2	A=Ø3X200mm B=850mm C=M9X1	SI - YES	

THERMOSTATS SINGLE PHASE / THERMOSTATS SINGLE PHASE

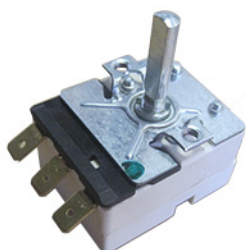

CODICE S&P S&P CODE	TEMPERATURA °C TEMPERATURE °C	N. POLI N. POLES	SCHEDA TECNICA DATA SHEET	CAPILLARE RICOPERTO CAPILLARY COVERED	ADATTABILITA' ADAPTABILITY
1106341	60-220°	2	A=Ø3,5X190mm B=600mm	SI - YES	236044:EUROTEC 236044: ELETTOBAR
1106264	50-300°	3	A=Ø3,1X160mm B=1200mm	SI - YES	15320005:NUOVA SIMONELLI
1106056	50-300°	2	A=Ø3,1X160mm B=1200mm	SI - YES	R65070210:LAINOX



CODICE S&P S&P CODE	TEMPERATURA °C TEMPERATURE °C	N. POLI N. POLES	SCHEDA TECNICA DATA SHEET	CAPILLARE RICOPERTO CAPILLARY COVERED	ADATTABILITA' ADAPTABILITY
1106282	95-190°	2	A=Ø6X131mm B=900mm C=M10X1	SI - YES	6010005: GIORIK 0108014:SILKO 808935:EMMEPI 058163:ELECTROLUX RTBF800163: MBM 862115: OFFCAR THE
1106320	40-200°	2	A=Ø6X77mm B=850mm C=M9X1	NO	

TERMOSTATI DI LAVORO MONOFASE / THERMOSTATS SINGLE PHASE



CODICE S&P S&P CODE	TEMPERATURA °C TEMPERATURE °C	N. POLI N. POLES	SCHEDA TECNICA DATA SHEET	CAPILLARE RICOPERTO CAPILLARY COVERED	ADATTABILITA' ADAPTABILITY
1106355	55-265°	2	A=Ø3X219mm B=2000mm	NO	

TERMOSTATI CON INTERRUETTORE MONOFASE / THERMOSTATS WITH SWITCH SINGLE PHASE



CODICE S&P S&P CODE	TEMPERATURA °C TEMPERATURE °C	N. POLI N. POLES	SCHEDA TECNICA DATA SHEET	CAPILLARE RICOPERTO CAPILLARY COVERED	ADATTABILITA' ADAPTABILITY
1106112	30-110°	2+4	A=Ø6X115mm B=890mm	NO	32Z9270:ANGELO PO
1106142	50-310°	2+4	A=Ø4X128mm B=1500mm	SI - YES	32V6510: ANGELO PO

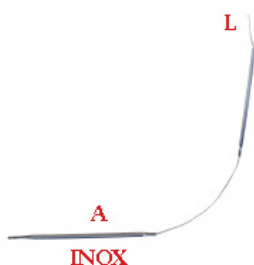

CODICE S&P S&P CODE	TEMPERATURA °C TEMPERATURE °C	N. POLI N. POLES	SCHEDA TECNICA DATA SHEET	CAPILLARE RICOPERTO CAPILLARY COVERED	ADATTABILITA' ADAPTABILITY
1106228	62-189°	2+4	A=Ø4X120mm B=700mm	SI - YES	CM097800:MARENO

TERMOSTATI CON INTERRUTTORE MONOFASE / THERMOSTATS WITH SWITCH SINGLE PHASE



CODICE S&P S&P CODE	TEMPERATURA °C TEMPERATURE °C	N. POLI N. POLES	SCHEDA TECNICA DATA SHEET	CAPILLARE RICOPERTO CAPILLARY COVERED	ADATTABILITA' ADAPTABILITY
1106288	90-185°	2+4	A=Ø4X230mm B=2400mm	NO	052330:ELECTROLUX
1106733	0-187°	2+4	A=Ø4X230mm B=2450mm	SI - YES	
1105030	260°		A=Ø4X120mm B=1270mm	SI - YES	002109:ELECTROLUX
1106698	100-615°	3+6	A=Ø4X230mm B=1100mm	SI - YES	53401100615:GICO

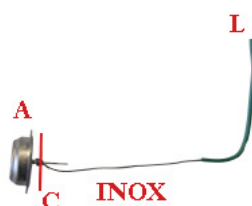
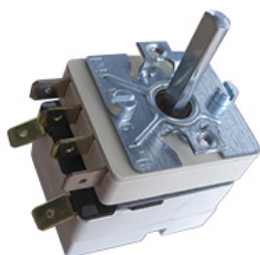

CODICE S&P S&P CODE	TEMPERATURA °C TEMPERATURE °C	N. POLI N. POLES	SCHEDA TECNICA DATA SHEET	CAPILLARE RICOPERTO CAPILLARY COVERED	ADATTABILITA' ADAPTABILITY
1106134	30-90	2+4	A=Ø23X10mm B=850mm C=31mm	SI - YES	32Z0410: ANGELO PO



CODICE S&P S&P CODE	TEMPERATURA °C TEMPERATURE °C	N. POLI N. POLES	SCHEDA TECNICA DATA SHEET	CAPILLARE RICOPERTO CAPILLARY COVERED	ADATTABILITA' ADAPTABILITY
1106168	105-185°	2+8	A=Ø21X84mm B=850mm C=25mm	SI - YES	6300738:ANGELO PO
1106172	185°	2+8	A=Ø21X84mm B=850mm C=25mm	SI - YES	6005040:ANGELO PO

TERMOSTATI CON INTERRUTTORE MONOFASE / THERMOSTATS WITH SWITCH SINGLE PHASE



CODICE S&P S&P CODE	TEMPERATURA °C TEMPERATURE °C	N. POLI N. POLES	SCHEDA TECNICA DATA SHEET	CAPILLARE RICOPERTO CAPILLARY COVERED	ADATTABILITA' ADAPTABILITY
1106125	270°	3+4	A=Ø3X220mm B=1000mm	NO	30064600:BERTO'S 921046:EUROTEC 921046:ELETTROBAR
1106173	60-320°	4+8	A=Ø4X130mm B=1500mm	SI - YES	32V0661: ANGELO PO

TERMOSTATI DI SICUREZZA MONOFASE / SAFETY THERMOSTATS SINGLE PHASE



CODICE S&P S&P CODE	TEMPERATURA °C TEMPERATURE °C	N. POLI N. POLES	SCHEDA TECNICA DATA SHEET	CAPILLARE RICOPERTO CAPILLARY COVERED	ADATTABILITA' ADAPTABILITY
1106732	125°	2	A=Ø6X77mm B=870mm	SI - YES	
1106470	140°	2	A=Ø3X226mm B=900mm	SI - YES	RTCP800067:EUROTEC
1106071	230°	2	A=Ø4X226mm B=1450mm	SI - YES	22170001:ELFRAMO
1106749	230°	2	A=Ø4X116mm B=1500mm	NO	
1106426	250°	2	A=Ø6X87mm B=1500mm	SI - YES	ED04900: OEM
1106272	320°	2	A=Ø6X80mm B=900mm	SI - YES	
1106745	350°	2	A=Ø3,1X201mm B=900mm	SI - YES	
1106447	500°	2	A=Ø3,9X230mm B=900mm	SI - YES	ED02300:OEM

TERMOSTATI DI SICUREZZA MONOFASE / SAFETY THERMOSTATS SINGLE PHASE



CODICE S&P S&P CODE	TEMPERATURA °C TEMPERATURE °C	N. POLI N. POLES	SCHEDA TECNICA DATA SHEET	CAPILLARE RICOPERTO CAPILLARY COVERED	ADATTABILITA' ADAPTABILITY
1106313	220°	2	A=Ø5X80mm B=900mm C=M10X1	SI - YES	RTBF900094:EUROTEC RTBF900094EX:ELETTROBAR
1106271	220°	2	A=Ø6X140mm B=1800mm C=M9X1	SI - YES	PR70008*: FABA 0108038*:SILKO BN6A049401:OLIS 53400112220:GICO
1106474	220°	2	A=Ø4X120mm B=850mm C=M9X1	SI - YES	5340011200:EUROTEC 5340011200:GICO
1106692	230°	2	A=Ø6X77mm B=860mm C=M10X1	SI - YES	0108038:SILKO 058164:ELECTROLUX 2011140: GIORIK 4185322001046:POLARIS/BARON



CODICE S&P S&P CODE	TEMPERATURA °C TEMPERATURE °C	N. POLI N. POLES	SCHEDA TECNICA DATA SHEET	CAPILLARE RICOPERTO CAPILLARY COVERED	ADATTABILITA' ADAPTABILITY
1106302	230°	2	A=Ø14X15mm B=900mm C=25mm	NO	66103400: MODULAR
1106697	230°	2	A=Ø14X28mm B=850mm C=25mm	SI	

TERMOSTATI DI SICUREZZA MONOFASE / SAFETY THERMOSTATS SINGLE PHASE



CODICE S&P S&P CODE	TEMPERATURA °C TEMPERATURE °C	N. POLI N. POLES	SCHEDA TECNICA DATA SHEET	CAPILLARE RICOPERTO CAPILLARY COVERED	ADATTABILITA' ADAPTABILITY
1106018	220°	4	A=Ø6X78mm B=900mm C=M9X1	NO	733100EX:MARENO



CODICE S&P S&P CODE	TEMPERATURA °C TEMPERATURE °C	N. POLI N. POLES	SCHEDA TECNICA DATA SHEET	CAPILLARE RICOPERTO CAPILLARY COVERED	ADATTABILITA' ADAPTABILITY
1106067	150°	2	A=Ø6X83mm B=900mm	SI - YES	LAR65070081: OLIS LAR65070081 ,LAR65075000, R65075000: LAINOX
1106760	245°	3	A=Ø6X74mm B=1300mm	SI - YES	
1106167	285°	3	A=Ø4X122mm B=1500mm	SI - YES	32Z5610:ANGELO PO
1106307	330°	2	A=Ø6X79mm B=900mm	SI - YES	R65070060:LAINOX

TERMOSTATI DI SICUREZZA MONOFASE / SAFETY THERMOSTATS SINGLE PHASE

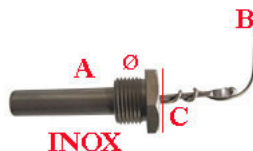

CODICE S&P S&P CODE	TEMPERATURA °C TEMPERATURE °C	N. POLI N.POLES	SCHEDA TECNICA DATA SHEET	CAPILLARE RICOPERTO CAPILLARY COVERED	ADATTABILITA' ADAPTABILITY
1106103	350°	2	A=Ø14X12 mm B=900mm C=24mm	SI - YES	32Z6790:ANGELO PO 002730:ELECTROLUX
1106362	350°		A=Ø14X16mm B=900mm	SI - YES	R65070070:LAINOX
1106475	360°	2	A=14X12mm B=880mm C=25mm	SI - YES	



CODICE S&P S&P CODE	TEMPERATURA °C TEMPERATURE °C	N. POLI N.POLES	SCHEDA TECNICA DATA SHEET	CAPILLARE RICOPERTO CAPILLARY COVERED	ADATTABILITA' ADAPTABILITY
1106082	235°	2	A=Ø4X86mm B=500mm	SI - YES	PR70008: FABA 25070000: BERTO'S



CODICE S&P S&P CODE	TEMPERATURA °C TEMPERATURE °C	N. POLI N.POLES	SCHEDA TECNICA DATA SHEET	CAPILLARE RICOPERTO CAPILLARY COVERED	ADATTABILITA' ADAPTABILITY
1106450	240°	2	A=Ø6x77mm B=1280mm C=M10X1	NO	6010006: GIORIK

TERMOSTATI DI LAVORO TRIFASE / THERMOSTATS THREE PHASE



CODICE S&P S&P CODE	TEMPERATURA °C TEMPERATURE °C	N. POLI N. POLES	SCHEDA TECNICA DATA SHEET	CAPILLARE RICOPERTO CAPILLARY COVERED	ADATTABILITA' ADAPTABILITY
1106283	30-90°	6	A=Ø6X129mm B=1480mm C=M10X1	SI - YES	1037035000:MARENO
1106411	30-90°	6	A=Ø6X150mm B=1500mm C=M12X1	SI - YES	
1106410	30-110°	6	A=Ø6X160mm B=1500mm C=M9X1	SI - YES	
1106304	32-110°	9	A=Ø6X138mm B=3000mm C=M9X1	SI - YES	808058:EMMEPI GRANDI CUCINE
1106266	30-110°	6	A=Ø6X140mm B=1500mm C=M9X1	NO	
1106267	95-180°	6	A=Ø6X133mm B=1800mm C=M9X1	SI - YES	66104100:MODULAR 33066200:BERTO'S 53401031820:GICO BN8219601:OLIS
1106300	95-195°	6	A=Ø6X120mm B=1700mm C=M9X1	SI - YES	X43800: GIGA MA643800: MARENO
1106409	50-200°	6	A=Ø6X120mm B=1500mm C=M9X1	SI - YES	
1106412	50-300°	6	A=Ø3X195mm B=1500mm C=M9X1	SI - YES	

TERMOSTATI DI LAVORO TRIFASE / THERMOSTATS THREE PHASE



CODICE S&P S&P CODE	TEMPERATURA °C TEMPERATURE °C	N. POLI N. POLES	SCHEDA TECNICA DATA SHEET	CAPILLARE RICOPERTO CAPILLARY COVERED	ADATTABILITA' ADAPTABILITY
1106735	60-185°	6	A=Ø4X230mm B=1200mm	SI - YES	005940: ELECTROLUX
1106346	100-285°		A=Ø3X219mm B=1150mm	SI - YES	
1106268	50-300°	6	A=Ø4X292mm B=1440mm	NO	
1106236	50-320°	6	A=Ø3X219mm B=1200mm	NO	0101384: SILKO
1106020	50-350°	6	A=Ø3X226mm B=1500mm	SI - YES	0A2206: ELECTROLUX 1037035200EX: MARENO K24015: A.T.A.
1106269	100-350°	6	A=Ø6X80mm B=1800mm	NO	
1106270	50-470°	6	A=Ø4X308mm B=990mm	NO	

TERMOSTATI CON INTERRUOTTORE TRIFASE / THERMOSTATS WITH SWITCH THREE PHASE

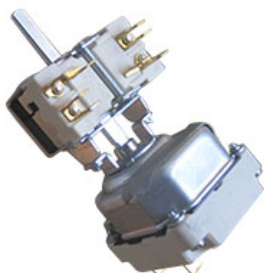

CODICE S&P S&P CODE	TEMPERATURA °C TEMPERATURE °C	N. POLI N. POLES	SCHEDA TECNICA DATA SHEET	CAPILLARE RICOPERTO CAPILLARY COVERED	ADATTABILITA' ADAPTABILITY
1106176	30-110°	6+6	A=Ø6X130mm B=1200mm	SI - YES	32V0060: ANGELO PO
1106165	100-260°	6+8	A=Ø6X80mm B=900mm	SI - YES	32Z7400: ANGELO PO
1106163	65-300°	6+13	A=Ø3X220mm B=1400mm	SI - YES	32Z3551: ANGELO PO
1106164	100-300°	6+8	A=Ø3,5X78mm B=1200mm	SI - YES	32Z3790: ANGELO PO

TERMOSTATI CON INTERRUTTORE TRIFASE / THERMOSTATS WITH SWITCH THREE PHASE



CODICE S&P S&P CODE	TEMPERATURA °C TEMPERATURE °C	N. POLI N. POLES	SCHEDA TECNICA DATA SHEET	CAPILLARE RICOPERTO CAPILLARY COVERED	ADATTABILITA' ADAPTABILITY
1106296	650°C (50,50- 600,70-650°C)	6+4	A=Ø4X23mm B=900mm	SI - YES	

TERMOSTATI DI SICUREZZA TRIFASE / SAFETY THERMOSTATS THREE PHASE



CODICE S&P S&P CODE	TEMPERATURA °C TEMPERATURE °C	N. POLI N. POLES	SCHEDA TECNICA DATA SHEET	CAPILLARE RICOPERTO CAPILLARY COVERED	ADATTABILITA' ADAPTABILITY
1106298	118°	6	A=Ø6x78mm B=1000mm	SI - YES	22100002:ELFRAMO
1106406	135°		A=Ø3,1X225mm B= 900mm	SI - YES	RTCP900074:EUROTEC
1106233	140°	6	A=Ø4X126mm B=900mm	SI - YES	9041033:HEMERSON 984140000:GRUPPO CIMBALI 1037305000:MARENO
1106714	140°	7	A=Ø6X88mm B=900mm	SI - YES	LAR65070020:LAINOX
1106104	150°		A=Ø6X80mm B=1500mm	SI - YES	002711:ELECTROLUX
1106277	169°	6	A=Ø4X128mm B=900mm	SI - YES	34200095:RANCILIO
1106408	187°		A=Ø4X125mm B=1000mm	SI - YES	34200096:RANCILIO
1106274	230°	6	A=Ø6X220mm B=1700mm	SI - YES	33070800:BERTO'S
1106133	230°	6	A=Ø6,5X240mm B=850mm	NO	22150002ex:ELFRAMO

S&P Cooking Catalogue 2017

CODICE S&P S&P CODE	TEMPERATURA °C TEMPERATURE °C	N. POLI N. POLES	SCHEDA TECNICA DATA SHEET	CAPILLARE RICOPERTO CAPILLARY COVERED	ADATTABILITA' ADAPTABILITY
1106734	230°	6	A=Ø6X82mm B=880mm	SI - YES	0C4463: ELECTROLUX
1106170	240°	6	A=Ø6X87mm B=2000mm	SI - YES	32Z3631: ANGELO PO
1106763	270°	7	A=Ø6X74mm B=2000mm	SI - YES	
1106275	320°	6	A=Ø6X176mm B=1450mm	SI - YES	
1106174	350°	7	A=Ø4X120mm B=1300mm	SI - YES	32Z9201: ANGELO PO
1106285	350°		A=Ø6X175mm B=950mm	SI - YES	051454: ELECTROLUX
1106276	360°	7	A=Ø4X120mm B=1500mm	SI - YES	0101375: SILKO 053980: ELECTROLUX 22069700: BERTO'S
1106178	360°	3	A=Ø4X120mm B=1500mm	SI - YES	32Z1400: ANGELO PO 003594: ELECTROLUX.

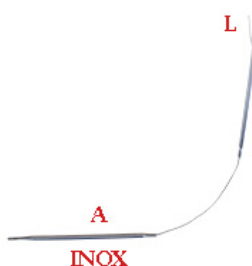

CODICE S&P S&P CODE	TEMPERATURA °C TEMPERATURE °C	N. POLI N. POLES	SCHEDA TECNICA DATA SHEET	CAPILLARE RICOPERTO CAPILLARY COVERED	ADATTABILITA' ADAPTABILITY
1106382	230°	6	A=Ø4X120mm B=900mm	SI - YES	CM097700EX: SILKO CM097700EX: MARENO

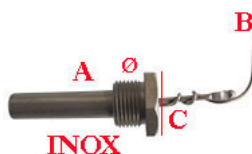

CODICE S&P S&P CODE	TEMPERATURA °C TEMPERATURE °C	N. POLI N. POLES	SCHEDA TECNICA DATA SHEET	CAPILLARE RICOPERTO CAPILLARY COVERED	ADATTABILITA' ADAPTABILITY
1106175	135°	6	A=Ø14X27,5mm B=1000mm	SI - YES	32Z9620: ANGELO PO
1106713	338°	5	A=Ø10X53mm B=900mm	SI - YES	007042: ELECTROLUX
1106238	330°	6	A=Ø14X18,5mm B=900mm	SI - YES	GIRRAROSTI VENTILATI: CB

TERMOSTATI DI SICUREZZA TRIFASE / SAFETY THERMOSTATS THREE PHASE



CODICE S&P S&P CODE	TEMPERATURA °C TEMPERATURE °C	N. POLI N. POLES	SCHEDA TECNICA DATA SHEET	CAPILLARE RICOPERTO CAPILLARY COVERED	ADATTABILITA' ADAPTABILITY
1106198	150°	9	A=Ø6X90mm B=1500mm C=M9X1	SI - YES	32Z2710:ANGELO PO
1106290	225°	6	A=Ø6X94mm B=900mm C=M10X1	NO	RTBF800164: MBM 60010037:GIORIK
1106398	235°	6	A=Ø4X120mm B=1800mm C=M9X1	SI - YES	
1106255	245°	6	A=Ø6X95mm B=800mm C=M10X1	SI - YES	807349:EMMEPI GRANDI CUCINE
1106294	250°	6	A=Ø6X107mm B=1000mm C=M9X1	SI - YES	66104800:MODULAR
1106065	340°	5	A=Ø4X222mm B=1250mm C=M17X1	SI - YES	3111950: ANGELO PO



CODICE S&P S&P CODE	TEMPERATURA °C TEMPERATURE °C	N. POLI N. POLES	SCHEDA TECNICA DATA SHEET	CAPILLARE RICOPERTO CAPILLARY COVERED	ADATTABILITA' ADAPTABILITY
1106335	135°	7	A=Ø6X80mm B=900mm C=M9X1	NO	MA1878900:SILKO 1878900:MARENO

TERMOSTATI DI SICUREZZA TRIFASE / SAFETY THERMOSTATS THREE PHASE



CODICE S&P S&P CODE	TEMPERATURA °C TEMPERATURE °C	N. POLI N. POLES	SCHEDA TECNICA DATA SHEET	CAPILLARE RICOPERTO CAPILLARY COVERED	ADATTABILITA' ADAPTABILITY
1106180	160°	6	A=Ø6X80mm B=900mm	SI - YES	32Z9210:ANGELO PO
1106006	230°	6	A=Ø6x89mm B=3000mm	SI - YES	MA1982000:MARENO
1106293	360°	6	A=Ø6X79mm B=850mm	NO	1878500:SILKO MA1878500:MARENO



CODICE S&P S&P CODE	TEMPERATURA °C TEMPERATURE °C	N. POLI N. POLES	SCHEDA TECNICA DATA SHEET	CAPILLARE RICOPERTO CAPILLARY COVERED	ADATTABILITA' ADAPTABILITY
1106033	170°	2	A=Ø3X155mm B=400mm	SI - YES	031482:ELECTROLUX

1106053 TERMOST
ATO -35/+35 F/2000
MONOFASE -
SENSORE Ø
6,5X115mm
CAPILLARE 1500mm /
THERMOSTAT -
35/+35 F/200 SINGLE
PHASE -SENSOR Ø
6,5X115mm
CAPILLARY 1500mm
80583002:
IRF- C&D-
FIOCCHETTI

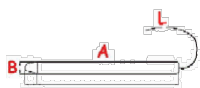

A= 115mm, B= 6,5mm,
L= 1500mm

1106709 TERMOST
ATO IM 0-90°C.TC/2
542564 /
THERMOSTAT 0-90 °
C.TC IM / 2 542564
120515:
COMENDA ALI SPA



1106424 KIT
 TERMOSTATO DI
 SICUREZZA /
 SAFETY
 THERMOSTAT KIT
 120520:
 COMENDA ALI SPA
 H120520:
 HOONVED - ALI
 SPA



1106326 KIT
 TERMOSTATO
 AUSILIARIO /
 THERMOSTAT KIT
 CM814533480:
 CASTEL MAC SPA
 CM81453348:
 SCOTSMAN ICE
 SRL



1106015 TERMOST
 ATO 160°-190°
 FRIGGITRICE A.PO
 SENSORE Ø 20X126
 mm CAPILLARE
 126mm /
 FRYER
 THERMOSTAT 160°-
 190° A.PO SENSOR Ø
 20X126 mm
 CAPILLARY 126mm
 6300359:
 ANGELO PO
 GRANDI CUCINE
 SPA

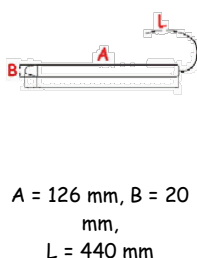

1106146 TERMOME
 TRO D. 52 0-120°
 CAP.1500mm -
 SENSORE Ø 6X40 mm
 CAPILLARE 1500mm /
 THERMOMETER D.52
 0.120° CAP.1500mm
 SENSOR Ø 6X40 mm
 CAPILLARY 1500mm
 1037104500:
 MARENO
 INDUSTRIE
 H450905:
 HOONVED - ALI
 SPA
 450905:
 COMENDA ALI SPA

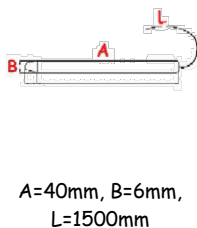

1106220 TELETER
 MOMETRO 0-120°
 D.60mm CAPILLARE
 1500X6 /
 THERMOMETER 0-
 120° D.60mm 1500X6
 00074420*:
 ELFRAMO SPA
 32100003*:
 ELFRAMO SPA

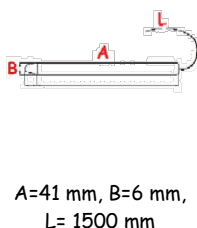

1106292 TERMOME
 TRO D=52 0/250°C /
 THERMOMETER
 D=52 0/250°C
 161827:
 MBM- EUROTEC SRL
 - DIV. COOKING
 SERVICE
 483004:
 MBM- EUROTEC SRL
 - DIV. COOKING
 SERVICE
 161827:
 ELETTROBAR
 DIVISIONE DELLA
 EUROTEC SRL
 32100002:
 ELFRAMO SPA

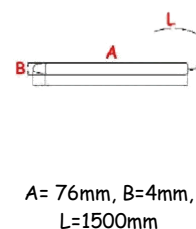

1106054 TERMOME
 TRO D.52 50/350° -
 SENSORE Ø 6X28mm
 CAPILLARE 1500mm /
 THERMOMETER
 D.52 50/350° -SENSOR
 Ø 6X28mm
 CAPILLARY 1500mm
 LAR65340050:
 MARENO
 INDUSTRIE ALI
 SPA
 0593: FOINOX
 S.P.A.
 LAR65340050:
 LAINOX ALI SPA

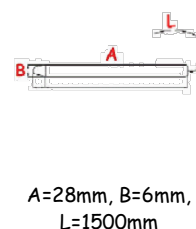

1106211 TERMOME
 TRO ANGELO PO 0-
 350°C D.52MM /
 THERMOMETER
 A.PO
 3220151:
 ANGELO PO
 GRANDI CUCINE
 SPA

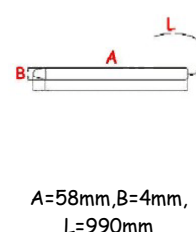

1106329 TERMOME
 TRO D=60 0/120°C /
 THERMOMETER
 D=60 0/120°C
 32100003:
 ELFRAMO SPA



1106191 TERMOME
 TRO 0-350° D.60mm
 CAPILLARE 1500X6 /
 THERMOMETER 0-
 350° D.60mm 1500X6

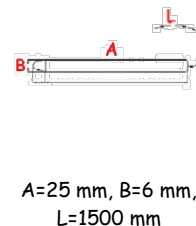

1106484 TERMOME
TRO D.52 +40/-40 /
THERMOMETER D.52
+40 / -40



1106472 TERMOME
TRO CIRCOLARE
D.52 mm CPNF -40+40
/
D.52 ROUND
THERMOMETER -40
+40 mm CPNF



DIAMETER=52MM

1106210 TELETER
MOMETRO -40+40
D.60 CF72 /
THERMOMETER-
40+40 D.60 CF72



A=50mm,B=6mm,
L=1500mm

1106195 TERMORE
GOLATORE 0-120°
72X72X1500 /
THERMOSTAT 0-120°
72X72X1500



A=57mm, B= 7mm,
L=1500mm

1106118 TERMOST
ATO TQ60 0/500°
FERMO 400°
MONOFASE -
SENSORE Ø 8X145
mm CAPILLARE
1100mm /
THERMOSTAT TQ60
0/500° SINGLE PHASE
- SENSOR Ø 8X145
mm CAPILLARY
1100mm
ED02200:
OEM ALI SPA



A=145mm,B=8mm,
L=1100mm,

1106188 TERMOME
TRO 0-120°
58X25X1500 /
THERMOMETER 0-
120° 58X25X1500
5693:
ARISTARCO
KASTEL
1106188: EURO 2000
13725: A.T.A. SRL
CETEM:
OMNIWASH SRL
DW10500005:
DIHR-ALI SPA
4507:
UNIVER-BAR SRL

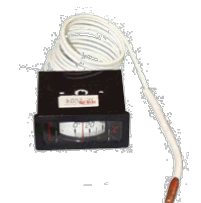

23236:
HOONVED - ALI
SPA
9140214*:
GRUPPO CIMBALI
SPA
32110003:
ELFRAMO SPA
977034000:
GRUPPO CIMBALI

1106196 TERMOME
TRO 0-120
CAP.3000mm 6,5X20 /
THERMOMETER 0-
120 3000mm 6,5X20
14198: FABAR SRL
907090:
SILANOS SRL



A=20 mm, B=7mm,
L=3000mm

1106323 TERMOME
TRO
RETTANGOLARE P
43E-P 48E /
DISH-WASHER
THERMOMETER P
43E- P 48E
DW10500011:
DIHR-ALI SPA
9131500:
GRUPPO CIMBALI
SPA
5576:
ARISTARCO
KASTEL SPA
984124000:
GRUPPO CIMBALI



1106425 TERMOME
TRO PER PASSPORT
45.30-50.32-1040
62X11MM 20-130°C /
THERMOMETER
FOR PASSPORT 45.30-
50.32-1040 62X11MM
20-130°C
5576:
ARISTARCO
KASTEL SPA



1106061 TERMOME
TRO DIG. FISS. CLIPS
DTE+ SCATOLA--
50+70°C /
CLIPS FASTENER
DIGITAL
THERMOMETER DTE
1188017:
MONDIAL GROUP
S.R.L.



1106077 TERMOMETRO PER FREEZER - 50+70 / REFRIGERATOR THERMOMETER - 50+70



1106025 TERMOMETRO DIGITALE - 50+260° / DIGITAL THERMOMETER 50+260°



1106204 TERMOMETRO PER FORNO / THERMOSTAT FOR OVEN



1106466 TERMOIGROMETRO ELETTRONICO CON MIN/MAX / THERMOIGROMETER



1106467 TERMOIGROMETRO CON SONDA INTERNO/ESTERNO / THERMOIGROMETER WITH INTERNAL/EXTERNAL PROBE



1106218 TERMOMETRO DIGITALE CON SONDA FISSA - 50+150 / DIGITAL THERMOMETRE WITH FIXED PROBE - 50+150



1106318 TERMOMETRO DIGITALE CON SONDA FISSA - 50°C+300°C / DIGITAL THERMOMETER WITH FIXED PROBE - 50°C+300°C



1106131 TERMOMETRO INFRAROSSI - 18+400° / INFRA-RED THERMOMETER - 18+260°



1106075 TERMOMETRO ABS -40+40 / ALCOHOL MOPLER THERMOMETER - 40+40



1106076 TERMOMETRO MOPLER -50+50 / ALCOHOL ABS THERMOMETER - 40+40



1106688 "THERMOREGOLATORE; EWPX174/L -4 C" / "THERMOREGULATOR; EWPX174 / L -4 C"



087161EX: ELECTROLUX
085975EX: ELECTROLUX
089904EX: ELECTROLUX
050788:ELECTROLUX

1106365 TERMOMETRO DIGITALE / DIGITAL THERMOMETER



32Z8250: ANGELO PO
GRANDI CUCINE SPA
TR0402: SILANOS SRL

1106240 TERMOSTATO DIGITALE 0-250° 230V SENZA SONDA IC912 / DIGITAL THERMOSTAT 0-250° 230V WITHOUT PROBE



GV: CB SRL

1106241 TERMOSTATO DIGITALE 0-99° 230V SENZA SONDA / DIGITAL THERMOSTAT 0-99° 230V WITHOUT PROBE



VR-EV-ESP/2: CB SRL

1106428 TERM.IC
912 TCJ
230V.PR.SP.OEM /
THERMOSTAT IC 912
TCJ 230V.PR.SP.OEM
ED07700:
OEM ALI SPA



1106349 TERMORE
GOLATORE ELIWELL
IC912 /
THERMOSTAT
ELIWELL IC912



1106353 TERMORE
GOLA.ON-OFF
EV7401J7E000002 /
THERMOREGOLATO
R ON-OFF
EV7401J7E000002
6011125: GIORIK
SPA



1106696 CONTROL
LORE DI
TEMPERATURA A 1
GRADINO,
ALIMENTAZIONE
24/230 VAC INGRESSI
ANALOGICIi1 per J/K
relè 1 da 8 A res. @ 250
VAC CON BUZZER /
TEMPERATURE
CONTROLLER TO 1
STEP, POWER 24/230
VAC INPUT
ANALOGICIi1 J / K
relay 1 8 res. @ 250
VAC WITH BUZZER



1106423 IGROMET
RO IC 915/R 84X2
230V UMIDITA' /
HYGROMETER IC
915/R 84X2 230V



1106453 TERMOST
ATO VISUALIZZATO
GUIDA DIN, 1 PUNTO
DI INTERVENTO
230V /
DIGITAL
THERMOSTAT 230V



1106427 "TERMOC"
"J" D.2X250+CAVO
2,5MT" /
THERMOCOUPLE
D.2X250 + CABLE
2,5MT
ED06600:
OEM ALI SPA



1106073 TERMOST
ATO 180° MONOFASE
SICUREZZA /
SAFETY
THERMOSTAT 180°
SINGLE PHASE
*****.
RANCILIO SPA
PR10015: FABA SRL

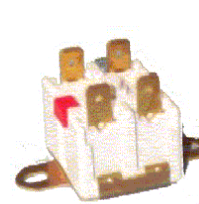

1106309 TERMOST
ATO 2
TEMP.9.2480.O1/130[/
THERMOSTAT 2
TEMP.9.2480.O1/130[



SPIE LUMINOSE / LUMINOUS LIGHTS

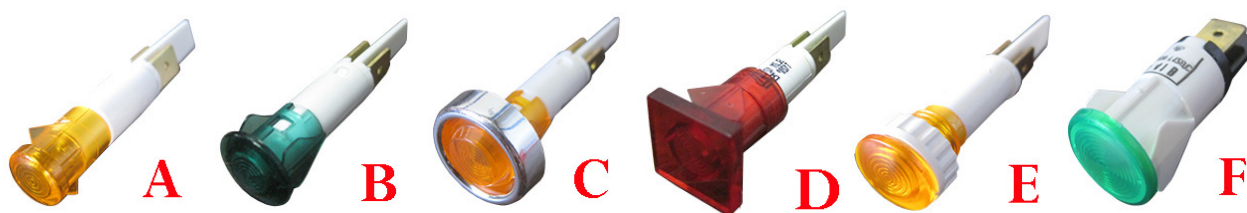

S&P CODE	TYPE	DIMENSIONI DIMENSIONS	V	COLORE COLOR	S&P CODE	TYPE	DIMENSIONI DIMENSIONS	V	COLORE COLOR
1104013	A	Ø=10mm	230V	ARANCIO ORANGE	1104072	D	Ø=12mm	250V	VERDE GREEN
1104012	A	Ø=10mm	230V	VERDE GREEN	1104073	D	Ø=12mm	250V	ROSSO RED
1104071	B	Ø=10mm	250V	ARANCIO ORANGE	1104034	F	Ø=12mm	250V	ARANCIO ORANGE
1104070	B	Ø=10mm	250V	VERDE GREEN	1104033	F	Ø=12mm	250V	VERDE GREEN
1104107	B	Ø=10mm	250V	VERDE GREEN	1104032	F	Ø=12mm	250V	ROSSO RED
1104069	B	Ø=10mm	250V	ROSSO RED	1104042	E	Ø=10mm	380V	ARANCIO ORANGE
1104024	C	Ø=10mm	250V	ARANCIO ORANGE	1104044	E	Ø=10mm	380V	VERDE GREEN
1104025	C	Ø=10mm	250V	VERDE GREEN	1104043	E	Ø=10mm	380V	ROSSO RED
1104062	D	Ø=10mm	250V	ARANCIO ORANGE	1104066	B	Ø=10mm	400V	ARANCIO ORANGE
1104060	D	Ø=10mm	250V	VERDE GREEN	1104068	B	Ø=10mm	400V	VERDE GREEN
1104061	D	Ø=10mm	250V	ROSSO RED	1104067	B	Ø=10mm	400V	ROSSO RED
1104057	E	Ø=10mm	250V	ARANCIO ORANGE	1104232	B	Ø=10mm	12V	ROSSO RED
1104058	E	Ø=10mm	250V	VERDE GREEN	1104063	B	Ø=10mm	24V	ARANCIO ORANGE
1104059	E	Ø=10mm	250V	ROSSO RED	1104065	B	Ø=10mm	24V	VERDE GREEN
1104087	B	Ø=12mm	250V	ARANCIO ORANGE	1104064	B	Ø=10mm	24V	ROSSO RED
1104086	B	Ø=12mm	250V	VERDE GREEN	1104054	E	Ø=10mm	24V	ARANCIO ORANGE
1104085	B	Ø=12mm	250V	ROSSO RED	1104055	E	Ø=10mm	24V	VERDE GREEN
1104074	D	Ø=12mm	250V	ARANCIO ORANGE	1104056	E	Ø=10mm	24V	ROSSO RED



S&P CODE	TYPE	DIMENSIONI DIMENSIONS	V	COLORE COLOR	S&P CODE	TYPE	DIMENSIONI DIMENSIONS	V	COLORE COLOR
1104029	D	Ø=10mm L=200mm	230V	VERDE GREEN	1104078	F	Ø=6mm L=200mm	380V	VERDE GREEN
4118166	E	Ø=10mm L=400mm	230-400V	VERDE GREEN	1104077	F	Ø=6mm L=200mm	380V	ROSSO RED
1104084	F	Ø=6mm L=200mm	250V	ARANCIO ORANGE	1104237	D	Ø=10mm L=200mm	380V	VERDE GREEN
1104080	F	Ø=6mm L=200mm	250V	VERDE GREEN	1104051	C	Ø=10mm L=200mm	400V	ARANCIO ORANGE
1104083	F	Ø=6mm L=200mm	250V	ROSSO RED	1104053	C	Ø=10mm L=200mm	400V	VERDE GREEN
1104267	F	Ø=6mm L=200mm	250V	BLU BLUE	1104052	C	Ø=10mm L=200mm	400V	ROSSO RED
1104045	C	Ø=10mm L=200mm	250V	ARANCIO ORANGE	1104201	B	Ø=12mm	400V	ARANCIO ORANGE
1104047	C	Ø=10mm L=200mm	250V	VERDE GREEN	1104199	B	Ø=12mm	400V	VERDE GREEN
1104046	C	Ø=10mm L=200mm	250V	ROSSO RED	1104200	B	Ø=12mm	400V	ROSSO RED
1104178	A	Ø=12mm	250V	ARANCIO ORANGE	1104082	F	Ø=6mm L=200mm	24V	ARANCIO ORANGE
1104179	A	Ø=12mm	250V	VERDE GREEN	1104081	F	Ø=6mm L=200mm	24V	VERDE GREEN
1104177	A	Ø=12mm	250V	ROSSO RED	1104079	F	Ø=6mm L=200mm	24V	ROSSO RED
1104181	B	Ø=12mm	250V	ARANCIO ORANGE	1104048	C	Ø=10mm L=200mm	24V	ARANCIO ORANGE
1104182	B	Ø=12mm	250V	VERDE GREEN	1104050	C	Ø=10mm L=200mm	24V	VERDE GREEN
1104180	B	Ø=12mm	250V	ROSSO RED	1104049	C	Ø=10mm L=200mm	24V	ROSSO RED
1104076	F	Ø=6mm L=200mm	380V	ARANCIO ORANGE	1104222	D	Ø=10mm	24V	BIANCO WHITE



S&P CODE	TYPE	DIMENSIONI DIMENSIONS	V	COLORE COLOR	S&P CODE	TYPE	DIMENSIONI DIMENSIONS	V	COLORE COLOR
1104120	C	Ø=8mm	230V	FLUORESCENTE FLUORESCENT	1104176	B	10X34mm	400V	ARANCIO ORANGE
1104121	C	Ø=8mm	230V	BIANCO WHITE	1104175	B	10X34mm	400V	VERDE GREEN
1104037	D	Ø=8mm L=300mm	230V	VERDE GREEN	1104218	A	22X30mm	24V	ARANCIO ORANGE
1104041	A	22X30mm	230V	ARANCIO ORANGE	1104038	E	Ø=12mm		VERDE GREEN
1104039	A	22X30mm	230V	VERDE GREEN	1104036	E	Ø=12mm		ROSSO RED
1104040	A	22X30mm	230V	ROSSO RED	1104151	E	Ø=12mm		ARANCIO ORANGE
1104184	D	Ø=8mm L=300mm	115V	VERDE GREEN					

INTERRUTTORI / SWITCHES

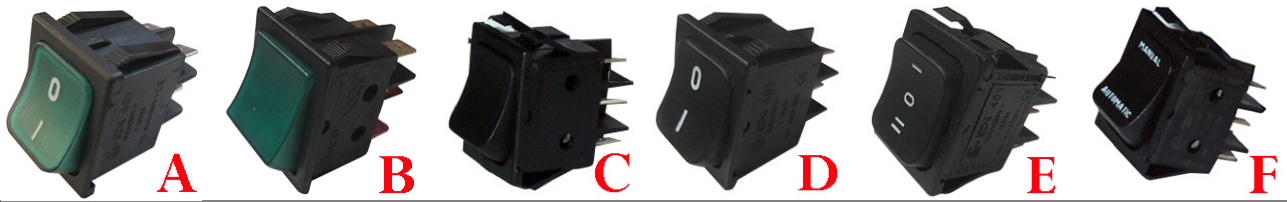

S&P CODE	TYPE	DIMENSIONI DIMENSIONS	POLI POLES	V	COLORE COLOR	S&P CODE	TYPE	DIMENSIONI DIMENSIONS	POLI POLES	V	COLORE COLOR
1105205	C	22X28mm	4	230V	NERO BLACK	1105198	A	22X30mm	4	230V 380V	VERDE GREEN
1105204	C	22X28mm	6	230V	NERO BLACK	1105345	A	22X30mm	5	230V	BLU BLUE
1105201	F	22X28mm	6	230V	NERO BLACK	1105045	A	22X30mm	4	230V	NON LUMINOSO NERO BLACK SWITCH NOT LUMINOUS
1105008	A	22X30mm	4	230V	VERDE GREEN	1105066	D	13X20mm	4	250V	NERO BLACK
1105007	A	22X30mm	6	230V	VERDE GREEN	1105045	D	22X30mm	4	250V	NERO BLACK
1105006	A	22X30mm	4	230V	ROSSO RED	1105178	E	22X28mm	6	250V	NERO BLACK
1105044	A	22X30mm	4	230V	ARANCIO ORANGE						

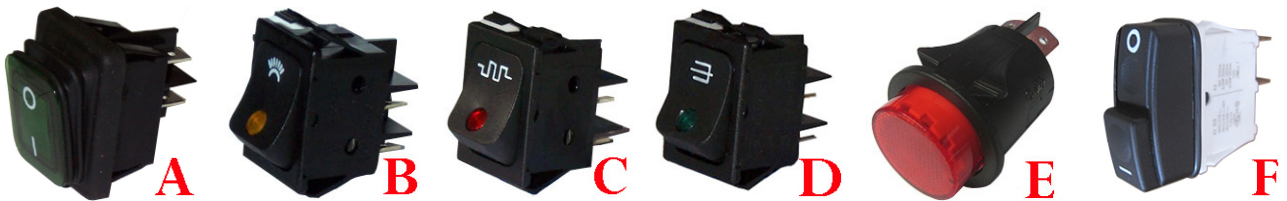

S&P CODE	TYPE	DIMENSIONI DIMENSIONS	POLI POLES	V	COLORE COLOR	S&P CODE	TYPE	DIMENSIONI DIMENSIONS	POLI POLES	V	COLORE COLOR
1105217	A	22X28mm	4	230V	VERDE GREEN	1105199	D	22X28mm	4	230V 380V	VERDE GREEN
1105246	A	22X28mm	4	230V	ARANCIO ORANGE	1105033	E	Ø=25mm	4	230V	ROSSO RED
1105247	A	22X28mm	4	230V	ROSSO RED	1105034	E	Ø=25mm	4	230V	ARANCIO ORANGE
1105200	B	22X28mm	4	230V 380V	ARANCIO ORANGE	1105035	E	Ø=25mm	4	230V	VERDE GREEN
1105196	C	22X28mm	4	230V 380V	ROSSO RED	1105405	F	11X27mm	2	250V	NERO BLACK



S&P CODE	TYPE	DIMENSIONI DIMENSIONS	POLI POLES	V	COLORE COLOR	S&P CODE	TYPE	DIMENSIONI DIMENSIONS	POLI POLES	V	COLORE COLOR
1105049	A	11X27mm	3	250V	NERO BLACK	1105053	C	22X30mm	4	250V	LUMINOSO LUMINOUS
1105185	B	11X27mm	3	250V	ARANCIO ORANGE	1105288	D	22X30mm	4	250V	ROSSO-VERDE RED-GREEN
1105375	B	11X27mm	3	250V	NERO BLACK	1105306	E	22X28mm	6	250V	BIANCO-NERO WHITE-BLACK

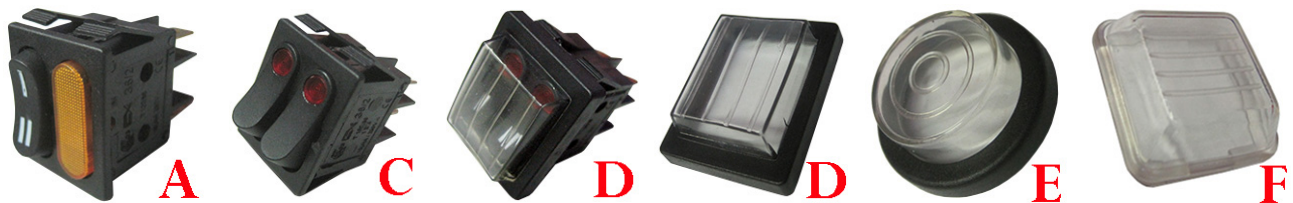

S&P CODE	TYPE	DIMENSIONI DIMENSIONS	POLI POLES	V	COLORE COLOR	S&P CODE	TYPE	DIMENSIONI DIMENSIONS	POLI POLES	V	COLORE COLOR
1105047	A	22X28mm	4	250V	ARANCIO ORANGE	1105037	D	CAPPuccio PROTEZIONE RETTANGOLARE RECTANGULAR PROTECTION CAP			
1105186	A	22X28mm	4	250V	BIANCO WHITE	1105038	E	CAPPuccio PROTEZIONE TONDO ROUND PROTECTION CAP			
1105050	B	22X28mm	6	250V	ROSSO RED	1105337	F	CAPPuccio PROTEZIONE QUADRATO SQUARE PROTECTION CAP			
1105206	C	22X28mm	6	230V 380V	ROSSO RED						

PULSANTI / PUSH-BUTTON



S&P CODE	TYPE	DIMENSIONI DIMENSIONS	POLI POLES	V	COLORE COLOR	S&P CODE	TYPE	DIMENSIONI DIMENSIONS	POLI POLES	V	COLORE COLOR
1108002	A	22X30mm	4	230V	GIALLO YELLOW	1108143	B	22X30mm	4	230V	ROSSO RED
1108032	A	22X30mm	4	230V	VERDE GREEN	1108122	C	25X25mm	4	230V	ROSSO RED
1108136	A	22X30mm	5	230V	GIALLO YELLOW	1108033	D	Ø=25mm	4	230V	NERO BLACK
1108134	A	22X30mm	6	230V	VERDE GREEN	1108158	E	Ø=25mm		250V	NERO BLACK
1108145	A	22X30mm	2	230V	NON LUMINOSO NERO BLACK SWITCH NOT LUMINOUS	1108159	F	Ø=25mm		250V	NERO BLACK



S&P CODE	TYPE	DIMENSIONI DIMENSIONS	POLI POLES	V	S&P CODE	TYPE	DIMENSIONI DIMENSIONS	POLI POLES	V
1108057	A	19X24mm	2	230V	1108067	D	19X24mm	6	230V
1108058	B	19X24mm	4	230V	1108068	E	19X30mm	6	230V
1108123	C	19X24mm	6	230V					



S&P CODE	TYPE	DIMENSIONI DIMENSIONS	POLI POLES	V	S&P CODE	TYPE	DIMENSIONI DIMENSIONS	POLI POLES	V
1105117	A	19X24mm	2	230V	1105389	D	19X30mm	3	230V
1105154	B	19X24mm	4	230V	1105245	E	19X30mm	6	230V
1105155	C	19X24mm	6	230V	1105170	F	19X30mm	6	230V
1105169	C	19X24mm	6 ORIZZONTALI 6 HORIZONTAL	230V					

TASTI / BUTTON



S&P CODE	TYPE	DIMENSIONI DIMENSIONS	COLORE COLOR	S&P CODE	TYPE	DIMENSIONI DIMENSIONS	COLORE COLOR
1105118	A	TASTO TONDO ROUND BUTTON	NERO BLACK	1105127	E	Ø=23mm	VERDE GREEN
1105119	A	TASTO QUADRATO SQUARE BUTTON	NERO BLACK	1105128	E	Ø=23mm	GIALLO YELLOW
1105120	B	TASTO TONDO ROUND BUTTON	NERO BLACK	1105175	E	Ø=23mm	GRIGIO GREY
1105121	B	TASTO QUADRATO SQUARE BUTTON	NERO BLACK	1105134	F	23X23mm	NERO BLACK
1105122	C	TASTO TONDO ROUND BUTTON	NERO BLACK	1105135	F	23X23mm	ROSSO RED
1105123	C	TASTO QUADRATO SQUARE BUTTON	NERO BLACK	1105136	F	23X23mm	BLU BLUE
1105226	D	TASTO RETTANGOLARE RECTANGULAR BUTTON	NERO BLACK	1105137	F	23X23mm	VERDE GREEN
1105125	E	Ø=23mm	ROSSO RED	1105138	F	23X23mm	GIALLO YELLOW
1105126	E	Ø=23mm	BLU BLUE				



S&P CODE	TYPE	DIMENSIONI DIMENSIONS	COLORE COLOR	S&P CODE	TYPE	DIMENSIONI DIMENSIONS	COLORE COLOR
1105129	A	Ø=23mm	NERO BLACK	1105143	B	23X23mm	GIALLO YELLOW
1105130	A	Ø=23mm	ROSSO RED	1105227	C	18X30mm	NERO BLACK
1105131	A	Ø=23mm	BLU BLUE	1105228	C	18X30mm	VERDE GREEN
1105132	A	Ø=23mm	VERDE GREEN	1105229	C	18X30mm	ROSSO RED
1105133	A	Ø=23mm	GIALLO YELLOW	1105230	C	18X30mm	BLU BLUE
1105139	B	23X23mm	NERO BLACK	1105231	C	18X30mm	GIALLO YELLOW
1105140	B	23X23mm	ROSSO RED	1105144	D	VERDE/ARANCIO PER DOMINO TONDO/QUADRO GREEN/ORANGE FOR ROUND/SQUARE DOMINO	
1105141	B	23X23mm	BLU BLUE	1105232	D	VERDE/ARANCIO PER DOMINO RETTANGOLARE GREEN/ORANGE FOR RECTANGUL. DOMINO	
1105142	B	23X23mm	VERDE GREEN	1108019	E	GRIGIO GREY	

1104122 STRUTTU
RA GUIDA LAMPADA
(X120-121) /
LAMP GUIDE
STRUCTURE (X120-
121)
32891:
HOONVED - ALI
SPA



SERVICE
054840:
ELECTROLUX
PROFESSIONAL
S.P.A.
32W0210:
ANGELO PO
GRANDI CUCINE
SPA

1104183 GHIERA
METALLICA BASSO
PROFILO PER
SEGNALE
ATORI D.12MM /
RING FOR LIGHT D.
12MM



1104256 LAMPADA
ALOG. V.220 H64861T
E14 /
HALOGEN LAMP
220V H64861T E14
EL06600:
OEM ALI SPA



1104017 LAMPADA
FORNO 300° 15W
230V E14 /
OVEN LAMP 300°
15W 230V E14
RTFOC00658:
MBM- EUROTEC SRL
- DIV. COOKING
SERVICE
MA2861900:
MARENO
INDUSTRIE ALI
SPA

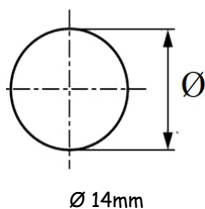

1104281 LAMPADA
ALOGENA OSRAM G4
20 W 12V H64428 /
HALOGEN LAMP
OSRAM G4 20 W 12V
H64428
EL07900:
OEM ALI SPA



1104166 LAMPADA
FORNO 300° 25W E14 /
LAMP FOR OVEN
300° 25W
RTFOC00037:
MBM- EUROTEC SRL
- DIV. COOKING

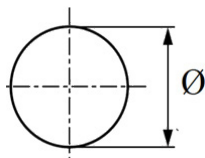

1104245 MICROLA
MP.ALOG.GY6.35 12V
35 W /
HALOGEN LAMP
GY6.35 12V 35W
EL06200:
OEM ALI SPA



1104248 LAMPADA
ALOG.V.220 G9 40 W /
HALOGEN LAMP
220V G9 40W
EL07400:
OEM ALI SPA



1104239 PORTALA
MPADA
ATT.MIGNON PER
FORNI CUCINE /
LAMPHOLDER
ATT.MIGNON FOR
OVENS



1104240 PORTALA
MPADE FORNI
ATT.MIGNON AD
ARISTON /
OVEN LAMPHOLDER
ATT.MIGNON AD
ARISTON



1104244 VETRO
LAMPADA
F.S2000+PJ+MF+DS /
OVEN LAMP GLASS
F.S2000 + PJ + MF +
DS
AL20100:
OEM ALI SPA



=2102500

1104262 VETRO
LAMPADA OVALE
SERIE BJB
77.717.1106.23 /
OVAL GLASS LAMP
SERIES BJB
77.717.1106.23
A87IL74007:
PIZZA GROUP S.R.L.



1104164 LAMPADA
25W 230V
C/PORTALAMPADA /
LAMP 25W 230V
WITH LAMP-HOLTER
FORNI PIZZA FP:
CB SRL



1104273 Ghiera
portalampada metallica /
metal holder ring
91410000:
CUPPONE F.LLI SRL



1104250 PARABOL
A LUCE IN
ALLUMINIO FORNI /
REFLECTOR LIGHT
ALUMINUM for
OVENS
UAT2200:
OEM ALI SPA



QAT2200:
OEM ALI SPA

1104257 PORTALA
MPADA 29.201.3703.00
/
Lampholder
29.201.3703.00
EL06900:
OEM ALI SPA



1104270 PORTALA
MPADA G9
77.208.U106.10 /
Lampholder G9
77.208.U 106.10
EL07300:
OEM ALI SPA

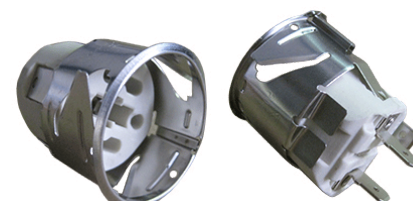

2 contatti

1104272 Portalampad
a E14 grande /
LAMP RECEPTACLE
WITH GLASS E14
91310186:
CUPPONE F.LLI SRL



1104159 PORTALA
MPADA NEON TL-D /
NEON LAMP-
HOLDER TL-D
ECV/SELF-EVF:
CB SRL



1104247 COMPL.PO
RTALAMPADA
FORNI /
OVENS LAMP
SOCKET
EL05600:
OEM ALI SPA



1104282 PORTALA
MPADA F.OPTYMO
77.912.U113.10 /
LAMPHOLDER
F.OPTYMO
77.912.U113.10
EL07700:
OEM ALI SPA



1104160 LAMPADA
NEON TLD15W /
NEON LAMP TLD
15W
ECV1050: CB SRL



1104161 LAMPADA
NEON TLD18W /
NEON LAMP TLD
18W
ECV/SELF2'76-
EVF2-EVF80-
EVF630: **CB SRL**



1104162 LAMPADA
NEON TLD23W /
NEON LAMP TLD
23W
ECV/SELF3110-
EVF3-EVF116:
CB SRL



1104163 LAMPADA
NEON TLD36W /
NEON LAMP TLD
36W
ECV/SELF 4143:
CB SRL



1105022 REGOLAT
ORE DI ENERGIA 13A
230V / ENERGY
GOVERNOR
OC1605:
**ELECTROLUX
PROFESSIONAL
S.P.A.**
PR4G002: **FABA SRL**
W-HOTDOG-SW1-
DIPA-
FP:E6P,E15P55,20PS
5,E30P55,E48S8,IR
400/500: **CB SRL**
TERM0050:
DR. ZANOLLI S.R.L.
REG001:
GARBIN S.R.L.
LA65080250:
**MARENO
INDUSTRIE ALI
SPA**



1105316 TESTA
SELETT. 3 POSIZ.
COMEPI /
SELECTOR 3 POS.
COMEPI
31420:
**HOONVED - ALI
SPA**



1115070 SELETTOR
E LUMINOSO VERDE
/ GREEN OPERATION
SWITCH
ED700:
**HOONVED - ALI
SPA**



1105412 PTM/10
INTERRUTTORE
EMERGENZA /
PTM / 10
EMERGENCY
SWITCH
RC916R0:
OEM ALI SPA



Ø=15mm

1105413 PTM/10
INTERRUTTORE
START /
PTM / 10 SWITCH
START
RC913R0:
OEM ALI SPA



Ø=15mm

1115097 SELETTOR
E 1-2-3 3 POSIZIONI
(DA M /
1-2-3 SWITCH 3-
POSITION
CESC6284NT:
**OMNIWASH SRL -
SOCIETA' A SOCIO
UNICO**



1105095 SELETTOR
E 0-1 /
SELECTOR 0-1
DW2000311:
DIHR-ALI SPA

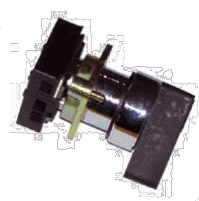

1115079 INTERRUT
TORE MONOFASE /
ROTATORY SWITCH
13186: **FABAR SRL**

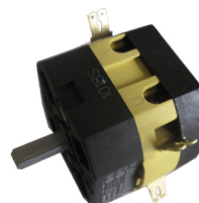

1115034 SELETTOR
E PROGRAMMI 4
POSIZIONI TIPO
NUOVO /
SELECTOR 4
POSITIONS NEW
TYPE
3168190:
LASA SRL

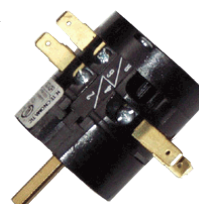

1115041 SELETTOR
E C/F 3 POSIZIONI
3SB30 00-2EA11 /
COMMUTATOR C/F 3
POS. 3SB30 00-2EA11
CRO413380:
**MARENO
INDUSTRIE ALI
SPA**



1105014 SELETTOR
E ATR ATA 13166 /
SWITCH ATR ATA
13166
13166:
A.T.A. SRL

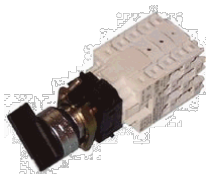

1105009 INTERRUT
TORE BIPOLEARE 16A
ATA /
BIPOLAR SWITCH
16A A TA
7606: A.T.A. SRL



1115017 SELETTOR
E 4 TEMPI 1-2-3-4 16A
DIHR / SELECTOR 4
TIME 1-2-3-4 16A
DIHR
DW10300208:
DIHR-ALI SPA



1105062 SELETTOR
E GENERALE
LOVATO
7GN209480U AC120 /
ROTARY SWITCH
7GN209480U AC120
7950: A.T.A. SRL



1115018 SELETTOR
E 5 POSIZIONI /
SELECTOR 5
POSITIONS
DW80411:
DIHR-ALI SPA



1105051 INTERRUT
TORE COM. GR. CD /
SWITCH COM. GR.
CD
34030006*:
RANCILIO SPA



1115022 SELETTOR
E 5 POS. LP2/3 /
SELECTOR 5
POSITIONS LP 2/3
DW80410:
DIHR-ALI SPA



1115011 COMMUT
ATORE 0-1 /
COMMUTATOR 0-1
34030026:
RANCILIO SPA



1115020 SELETTOR
E TEMP. 4 POS. 1-2-3-
4 16A /
TEMPERATURE
SELECTOR 4
POSITIONS 1-2-3-4
16A
DW10300207:
DIHR-ALI SPA

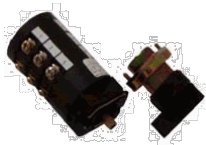

1115002 COMMUT
ATORE 2-0-1 LT /
COMMUTATOR 2-0-1
LT
34030027:
RANCILIO SPA



1105281 INTERRUT
. CON FASTON X
FORNO / SWITCH
WITH FASTON FOR
OVEN
632: ARISTARCO
SPA

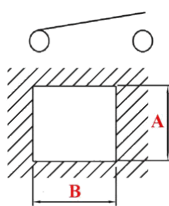

1105013 INTERRUT
TORE BIPOLEARE 16A
/
BIPOLAR SWITCH
16A
25100102:
ELFRAMO SPA



1105165 DEVIATO
RE BIPOLEARE 1-0-2
LEVETTA 10 A /
BIPOLAR SWITCH 1-
0-2 LEVER 10 A

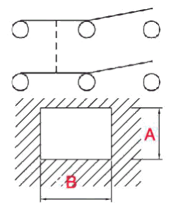
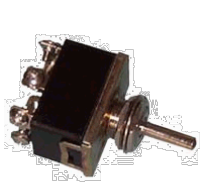

A = 20mm, B = 30mm

1115080 INTERRUT
TORE UNIPOLARE
12A / ROTARY
SWITCH 1 POLES 12A
25100001:
ELFRAMO SPA



1115081 INTERRUT
TORE TRIPOLARE
16A / ROTARY
SWITCH 3 POLES 16A
25110001:
ELFRAMO SPA



1105300 INTERR.
ROT. BIPOLARE /
BIPOLAR SWITCH
S000INA09QQQ:
MAZZER LUIGI SRL



1115102 COMMUT
ATORE QUADRATO
16AMP 614549 /
SWITCH 16AMP
SQUARE 614 549
120715:
COMENDA ALI SPA



1105275 INTERR.
ROT. TRIPOLARE /
3POLAR SWITCH
S000INA04AQQ:
MAZZER LUIGI SRL



1115060 COMMUT
ATORE -
COMMUTATOR /
COMMUTATOR
103590: KRUPPS
S.R.L.



1105290 INTERR.
ROT. BIPOL. + FASE
AUS. /
BIPOLAR SWITCH.
S000INA13QQQ:
MAZZER LUIGI SRL



1115045 SELETTOR
E 4CH 16(4)A-250V /
COMMUTATOR 4CH
16(4)A-250V
316810: LASA SRL



1115021 SELETTOR
E 0-1 SCH /
SWITCH 0-1 SCH
DW30009001:
DIHR-ALI SPA



1115056 INTERUTT
ORE QUADRIP. 16A
R708 / ROTARY
SWITCH 16A R708
213003:
ELETTROBAR
DIVISIONE DELLA
EUROTEC SRL



1105027 INTERRUT
TORE BIPOLARE B10-
18-F /
BIPOLAR SWITCH
B10-18-F
H120712:
HOONVED - ALI
SPA
120712:
COMENDA ALI SPA



1105203 COMMUT
ATORE BIPOLARE
GYROS ELETTRICI
CB /
BIPOLAR
COMMUTATOR
GYROS CB
GYROS ELETTRICO:
CB SRL

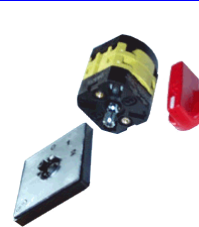

1105215 INTERRUT
TORE
QUADRIPOLARE 25A
500V /
SWITCH FOUR POLE
25A 500V
120736:
COMENDA ALI SPA



1115108 COMMUT
ATORE PER
VAMPIRA /
SELECTOR SWITCH
13186B: FABAR SRL



1105075 INTERR.Q
UADRIPOL.16A 3
POS. / FOUR-POLAR
SWITCH 16A 3
POSITIONS
120737:
COMENDA ALI SPA

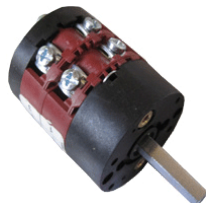

1115047 COMMUT
ATORE 5 POSIZIONI
CSO128618202 / 5
POSITIONS
COMMUTATOR
CSO128618202
926182: MBM
926182:
ELETTROBAR
DIVISIONE DELLA
EUROTEC SRL



1105289 INTERRUTTORE BIPOLARE 16A / BIPOLAR SWITCH 16A

161801:
EUROTEC SRL -
DIV. COOKING
SERVICE MBM
161801:
ELETTROBAR
DIVISIONE DELLA
EUROTEC SRL



1105073 INTERRUTTORE QUADRIPOLORE 16A.380V / FOUR-POLAR SWITCH 16A 380V

120744:
COMENDA ALI SPA



1115054 INTERRUTTORE AF78-AF61 / ROTARY SWITCH

7952: A.T.A. SRL



1105025 INTERRUTTORE GENERALE AT / MAIN SWITCH AT

9804: A.T.A. SRL



1105051 INTERRUTTORE COM. GR. CD / SWITCH COM. GR. CD

34030006*:
RANCILIO SPA



1115042 COMMUTATORE CS0128480041 (PER LAVASTOVIGLIE / COMMUTATOR CS0128480041

927034:
ELETTROBAR
927034: MBM



1105197 INTERRUTTORE HF32 COMPLETO DI PIASTRINA / SWITCH HF32

61RARROSTI
20/96P: CB SRL



1115095 SELETTOR E GENERALE AL DEP / ROTARY SWITCH AL DEP

7951: A.T.A. SRL



1115031 INTERRUTTORE ROT. TRIPOLARE + FASE AUSILIARIA / ROTARY SWITCH 4 - 3 OPERATING POSITIONS

5000INA10AQQ:
MAZZER LUIGI SRL



1105074 INTERRUTTORE ESAP.15A 4 POS. FC-A- / SWITCH 15A 4 POSITIONS FC-A

120740:
COMENDA ALI SPA



1115087 INTERRUTTORE ESAPOLARE 2 POSIZIONE / 2 POSITION SWITCH hexapolar

120722:
COMENDA ALI SPA



1105077 COMMUTATORE ESAPOL.16 AMP. / SIX-POLAR COMMUTATOR 16A

120716:
COMENDA ALI SPA

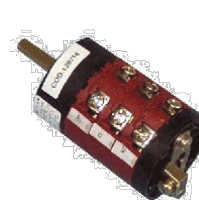

1105072 INTERRUTTORE ESAP.2 POS. B.V.S.HR / SWITCH 2 POSITIONS B.V.S.HR

120734:
COMENDA ALI SPA



1115023 INTERRUTTORE ETAP 4 SCATTI F 55-80-65 / ROTARY SWITCH 4 POSITIONS

120719:
COMENDA ALI SPA



1115090 COMMUTATORE 1-0-2 25A RESISTENZA / HEATING ELEMENT COMMUTATOR

EHO1000:
OEM ALI SPA



1105109 INTERRUTTORE OTTOPOLARE 16A 5 POS. / COMMUTATOR 16A 5 POS.

120729:

COMENDA ALI SPA



1105023 INTERRUTTORE OTTOPOLARE 16A 4P / EIGHTPOLAR SWITCH 16A 4P

120728:

COMENDA ALI SPA



1105112 FASTON FEMMINA 6,3X0,8 SEZ.1-2,5 OTTONE STAGNATO / FEMALE FASTON 6,3X0,8X SEZ. 1-2,5 TINNED BRASS



1105113 FASTON MASCHIO 6,3X0,8 SEZ.1-2,5 OTTONE STAGNATO / MALE FASTON 6,3X0,8X SEZ. 1-2,5 TINNED BRASS



1105114 COPRIFASTON FEMMINA 6,3X0,8 / FEMALE COVERFASTON 6,3X0,8



1105115 COPRIFASTON MASCHIO 6,3X0,8 / MALE COVERFASTON 6,3X0,8

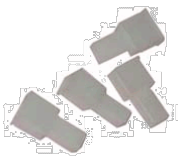

1105407 FASTON FEMMINA PREISOLATO RINFORZATO 6,3X0,8 SEZIONE 2,5 OTTONE STAGNATO / PRE-INSULATING REINFORCED FEMALE FASTON 6,3x0,8 SECTION 2.5 TINNED BRASS

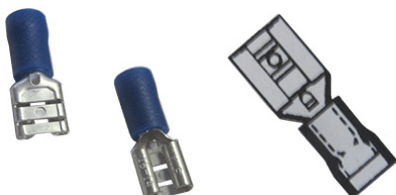

1105408 FASTON MASCHIO PREISOLATO RINFORZATO 6,3X0,8 SEZIONE 2,5 OTTONE STAGNATO / MALE FASTON 6,3x0,8 REINFORCED PRE-INSULATING SECTION 2.5 TINNED BRASS

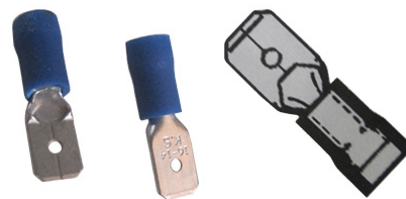

1105409 FASTON FEMMINA TOTALMENTE RINFORZATO PREISOLATO 6,3X0,8 SEZ.2,5 OTTONE STAGNATO / FASTON FEMALE FULLY REINFORCED PRE-INSULATING 6,3x0,8 SEZ.2,5 TINNED BRASS



1105410 CAPOCOR DA A FORCELLA PREISOLATO 8,1X0,8 FORO 5,3 SEZIONE 2,5 / TERMINALS FORK PRE-INSULATING 8,1X0,8 HOLE SECTION 5.3 2.5



1105428 MORSETTO IN STEATITE 2X4MMQ 450V / STEATITE CLAMP 2X4MMQ 450V



DIMENSIONS 25X22X19mm

1105429 MORSETTO IN STEATITE 3X4MMQ 450V / STEATITE CLAMP 3X4MMQ 450V



DIMENSIONS 25X33X19mm

1105329 INTERRUTTORE A CHIAVE / SWITCH

22723022:

CMA MACCHINE PER CAFFE' SRL



1108158 PULSANTE TEMPORANEO SP6014C1N0000 / PUSH BUTTON

CRO410290:

SILKO ALI SPA

CRO410290:

MARENO

INDUSTRIE



1108159 PULSANT
E /
PUSH BUTTON
053978:
ELECTROLUX
PROFESSIONAL
S.P.A.



1108128 K25 OFF
PUSH BUTTON /
K25 OFF PUSH
BUTTON
OD0364:
ELECTROLUX
PROFESSIONAL
S.P.A.



1108129 K25
PUKSE PUSH
BUTTON /
K25 PUKSE PUSH
BUTTON
OD0363:
ELECTROLUX
PROFESSIONAL
S.P.A.



1105096 PULSANT
E RASATO OPACO
BIANCO 3183 /
GREEN PUSH-
BUTTON 3183
DW3002053:
DIHR-ALI SPA



1108167 PULSANT
E VERDE VELOCITA'
2 /
2 SPEED PUSH
BUTTON



1108099 PULSANT
E ARRESTO /
STOP PUSH-BUTTON
32W4000:
ANGELO PO
TR0328:
SILANOS SRL



1108101 PULSANT
E LUMINOSO VERDE
32W1730 /
GREEN PUSH-
BUTTON 32W1730
32W1730:
ANGELO PO



1108137 PULSANT
E START COMPLETO
/ START PUSH-
BUTTON COMPLETE
VR-RX-PULSTART:
VELOX BARCHITTA
S.R.L.



1115043 SELETTOR
RE 0-1-2 COMPL.
1300 /
COMMUTATOR 0-1-2
1300
906210:
SILANOS SRL







1108168 PULSANT
E FUNGO ROSSO /
130426: COMENDA
ALI SPA





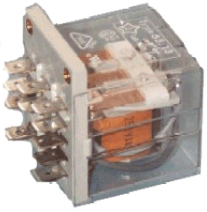
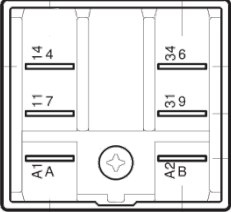
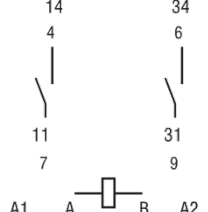
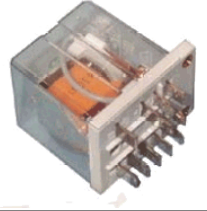
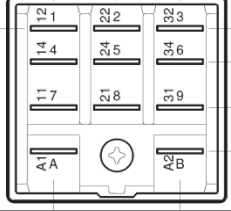
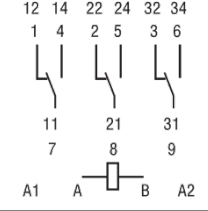
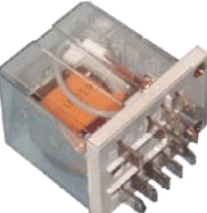
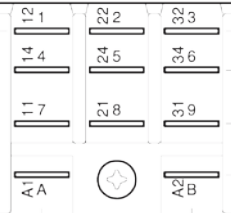
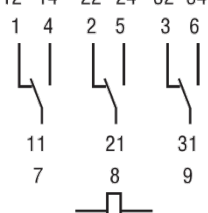
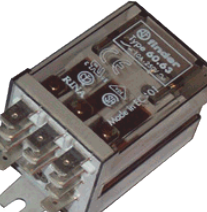
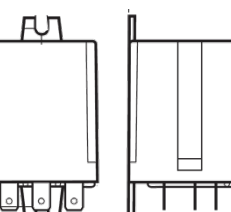
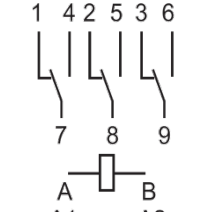

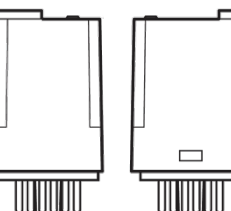
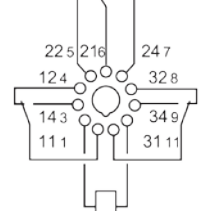
1108188 PULSANT
E ARRESTO A
FUNGO CON
BLOCCO /
STOP BUTTON
MUSHROOM WITH
BLOCK

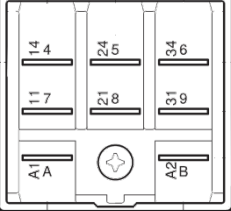
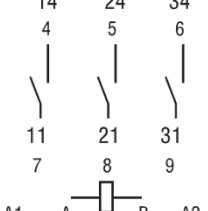

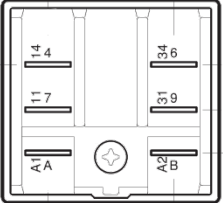
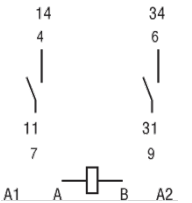
RELE'/RELAYS

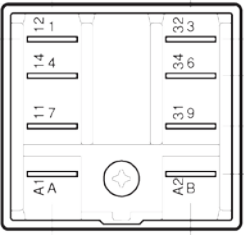
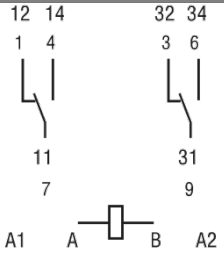
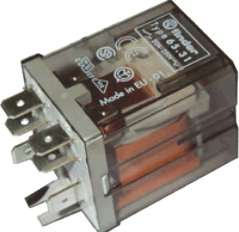
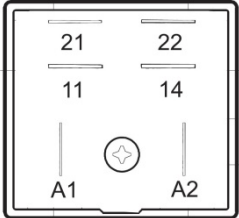
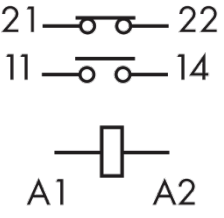
CODICE S&P S&P CODE		CONTATTI CONTACTS	SCHEMA ELETTRICO WIRING DIAGRAM	DESCRIZIONE DESCRIPTION
1109001				RELE' 230 V 16 AMPERE
1109005				RELE' 230 V 16 AMPERE
1109010				RELE' 24 V 16 AMPERE
1109015				RELE' 230V 10 AMPERE
1109021				RELE' 230V 10 AMPERE
1109024				RELE' 230V 16 AMPERE

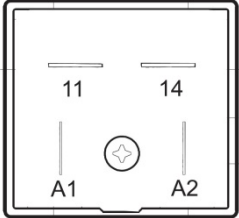
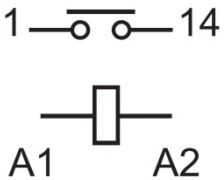
CODICE S&P S&P CODE		CONTATTI CONTACTS	SCHEMA ELETTRICO WIRING DIAGRAM	DESCRIZIONE DESCRIPTION
1109040				RELE' 230V 16 AMPERE
1109060				RELE' 230V 16 AMPERE
1109099				RELE' 230V 20 AMPERE
1109100				RELE' 230V 30 AMPERE

S&P Cooking Catalogue 2017

1109100 RELE' 30A

/

RELAY 30A

1LT028: MIGEL

S.R.L.

229029:

MBM- EUROTEC SRL
- DIV. COOKING
SERVICE

229029:

ELETTROBAR
DIVISIONE DELLA
EUROTEC SRL

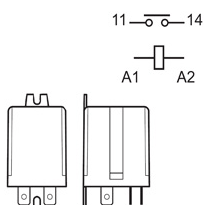

9531505700:

GRUPPO CIMBALI

SPA

33324:

HOONVED - ALI
SPA

EN125: OEM ALI
SPA

34312:

HOONVED - ALI
SPA

0301745:

LAMBER DI AFFABA
FRANCESCO & C.

25130100:

ELFRAMO SPA

LAR65170100:

LAINOX ALI SPA

LAR65170100:

OLIS DIVISIONE
DI ALI GROUP SPA

-

DER1108:

ELETTROBAR

1109040 RELE

FINDER 230V 50/60HZ

GUIDA DIR /

RELAY FINDER 230V

50/60HZ

DW560301:

DIHR-ALI SPA

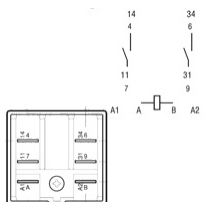

1109001 RELE' 230

16A /

RELAY 230 SILANOS

0301794:

LAMBER DI AFFABA
FRANCESCO & C.

CR0687240:

LAINOX ALI SPA

E229039:

HOBART GmbH

4271: A.T.A. SRL

905474*:

SILANOS SRL

DW16037:

DIHR-ALI SPA

229039:

ELETTROBAR
DIVISIONE DELLA
EUROTEC SRL

34200189:

RANCILIO SPA

CR0687240:

SILKO ALI SPA

4360:

UNIVER-BAR SRL

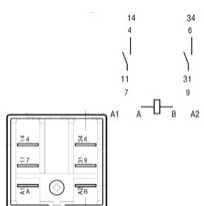

1109027 RELE'

220/50ATT/FAST.2SC

AMBI 10A /

RELAY 220/50

ATT/FAST.2

CHANGES 10A

229023:

ELETTROBAR

CM19620107:

SIMAG SPA

RI000761:

EURFRIGOR SRL

RI000761:

EURFRIGOR ICE

MAKERS SRL

CM19620107:

SCOTSMAN ICE

CM19620107/O:

CASTEL MAC SPA

926072:

BRICE ITALIA SRL

CM19620101/Oex:

CASTEL MAC SPA

25130102:

ELFRAMO SPA

819620107:

GRUPPO CIMBALI

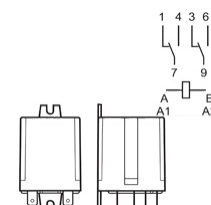

1109060 RELE' DI

POTENZA 16/250 /

RELAY 16/250

929115:

ELETTROBAR

DIVISIONE DELLA
EUROTEC SRL

34200037:

RANCILIO SPA

32Z2000:

ANGELO PO

GRANDI CUCINE

SPA

04200046:

NUOVA

SIMONELLI SPA

DW15620:

DIHR-ALI SPA

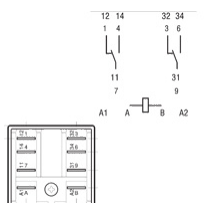

1109024 RELE'

TRIPOLARE 230V /

RELAY 230V MD80

229040:

ELETTROBAR

DIVISIONE DELLA

EUROTEC SRL

34200197*:

RANCILIO SPA

MD80: RANCILIO

SPA

0301795:

LAMBER DI AFFABA

FRANCESCO & C.

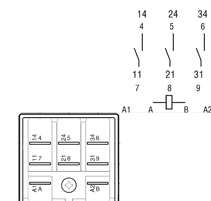
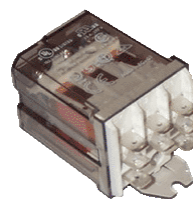

1109015 RELE' S20

220V /
RELAY S20 220V

RTFOC00144:

MBM- EUROTEC SRL
- DIV. COOKING
SERVICE

229024:

ELETTROBAR

23190:

BREMA ICE
MAKERS

056510:

ELECTROLUX

085296:

ELECTROLUX

086214:

ELECTROLUX
PROFESSIONAL
S.P.A.

056466:

ELECTROLUX
PROFESSIONAL
S.P.A.

62023702:

SCOTSMAN ICE
SRL

EU23190:

BRICE ITALIA SRL

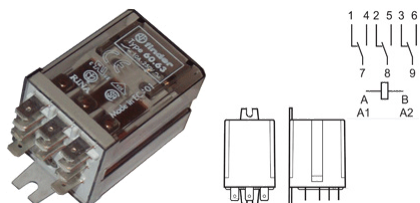

1109071 RELE' B1

230V AC-L /
RELAY B1 230V AC-L

*:

MBM- EUROTEC SRL
- DIV. COOKING
SERVICE

229008:

ELETTROBAR

DIVISIONE DELLA
EUROTEC SRL



1109046 RELE' A2-

230AC-L /
RELAY A2-230AC-L

229030:

ELETTROBAR
DIVISIONE DELLA
EUROTEC SRL



1109028 RELE'2NO

16 A 230VAC +
FASTON /

RELAY 2NO16 A
230VAC + FASTON

905476: SILANOS
SRL

905474EX:

SILANOS SRL

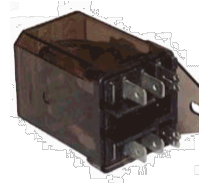

1109005 RELE'

FINDER TRIPOLARE

230V /

THREE POLAR

RELAY FINDER 230V

34200181:

RANCILIO SPA

34200192:

RANCILIO SPA

34200197:

RANCILIO SPA

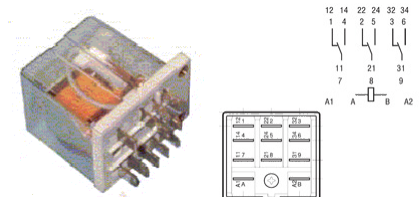

1109029 RELE' DI

POTENZA 3 SCAMBI

16A 250VAC /

POWER RELAY 3

CHANGES 16A

250VAC

905475: SILANOS
SRL



1109021 RELE' MD

50 FINDER /
RELAY MD 50

FINDER

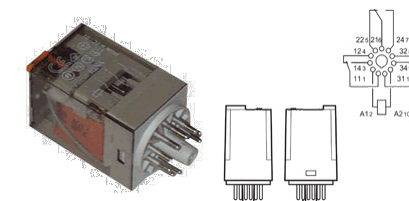

1109010 RELE'

FINDER TRIP.

62838024 24VCA /

THREE-POLAR

RELAY FINDER

62838024 24VCA

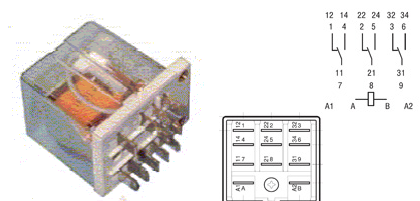

1109099 RELE 20A

230V /

RELAY 20A 230V

DER111:

COLGED

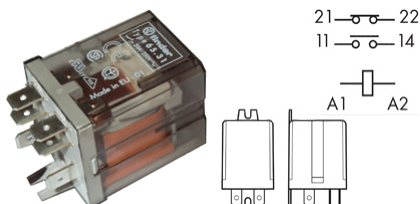

1109066 RELE

SKR115 230V CON

LED /

RELAY SKR115 230V

WITH LED

GIRR.CE VR-EV-
ESP/2: CB SRL



1109146 RELE' B2

230V AC-L /

RELE' B2 230V AC-L

229009:

ELETTROBAR

DIVISIONE DELLA
EUROTEC SRL

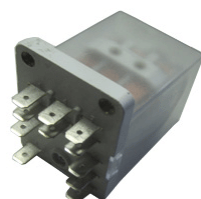

1109006 RITARDA

TORE 2 POMPA 220V

6" R /

"RELAY 2 PUMP 220V

6" R"

CETF604SA:
OMNIWASH SRL -
SOCIETA' A SOCIO
UNICO



1109121 "RITARDA
TORE 2A POMPA 24V
RIT. 5-7" 24V 62P" /
"TIME RELAY 24V
RIT. 5-7" 24V
62P" "

CETF60:

OMNIWASH SRL -
SOCIETA' A SOCIO
UNICO

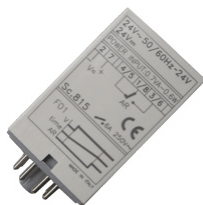

1109132 ADATTAT
ORE CON BOCCOLE
PER RELE' S.62 /
ADAPTER FOR
RELAY S.62



1109120 RELE'OMR
ON MK2P-S 230VAC /
RELAY OMRON
MK2P-S 230VAC

CM196201000:

CASTEL MAC SPA



1109150 RELAY /
RELAY

1800190350:

SCOTSMAN ICE
SRL



1109140 RELAY /
RELAY

IOM918101010:

SCOTSMAN ICE
SRL



1109149 RELAY /
RELAY

CM19621709:

SCOTSMAN ICE
SRL

CM196217090:

CASTEL MAC SPA



1109052 RELAY
SCOTSMAN /
RELAY SCOTSMAN

62016818:

SCOTSMAN ICE
SRL



1109156 RELAY /
RELAY

1800190329:

SCOTSMAN ICE
SRL



1109158 RELAY

9660.B451.131 /
RELAY 9660.B451.131

62005701:

SCOTSMAN ICE
SRL

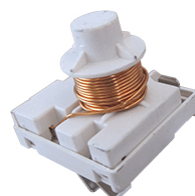

1109126 RELE'
MICRO PORTA 30A /
POWER RELAYS 30A

905486: SILANOS

SRL



1109002 CONTATT
ORE 12V CIMBALI

DC /

CONTACTOR 12V
CIMBALI



1109011 MINICONT
ATTORE AB 230V NO

/
MINICONTACTOR
AB 230V

*****:

RANCILIO SPA

1109011: CARIMALI

HR0910: ADLER

S.P.A.

9041202:

GRUPPO CIMBALI

SPA

EN005: OEM ALI

SPA

34200332:

RANCILIO SPA

34200219:

RANCILIO SPA

984144000:

GRUPPO CIMBALI

SPA



1109042 TELERUT
TORE A.PO 220/230

2083 /
CONTACTOR A.PO
220/230 2083

32Z2083:

ANGELO PO

GRANDI CUCINE

SPA

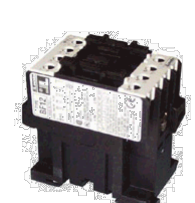

S&P Cooking Catalogue 2017

1109043 TELERUT
TORE 220/230 A.PO
2091 /
CONTACTOR 220/230
A.PO 2091

3ZZ2091:

ANGELO PO
GRANDI CUCINE
SPA



1109048 TELERUT
TORE 220-230V APO /
CONTACTOR A.PO
220-230V

32V0980:

ANGELO PO
GRANDI CUCINE
SPA

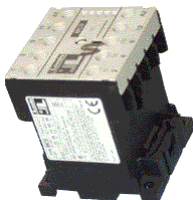

1109090 TELERUT
TORE 230V 50-60HZ
20A AC1
MINICONTATTORE /
CONTACTOR 230V
50-60HZ 20A AC1

31873:

HOONVED - ALI
SPA

355:

ARISTARCO
KASTEL SPA



1109102 CONTATT
ORE 230V 50HZ
4.2KW AC3 POMPA
(11BF9) /
CONTACTOR 230V
50HZ 4.2KW AC3
PUMP (11BF9)

4375:

ARISTARCO
KASTEL SPA

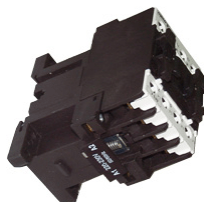

1109098 TELERUT
TORE 240V 50HZ NO /
RELAY 240V 50HZ
NO

23594:

BREMA ICE
MAKERS SPA

DW15086/B:

DIHR-ALI SPA



1109112 TELERUT
TORE /
RELAY

23147:

BREMA ICE
MAKERS SPA



1109141 TEL.11BG1
2.01A 220-230/5060/1 /
CONTACTOR
11BG12.01A 220-
230/5060/1

CM337307120:

CASTEL MAC SPA



CM33730712:

SCOTSMAN ICE
SRL

1109105 CONTACT
OR /
CONTACTOR

CMCF63012405:

CASTEL MAC SPA
63012405:

SCOTSMAN ICE
SRL



1109064 CONTATT
ORE CB /
CONTACTOR CB

6V-EV/VDE-

E8P/12P- FP-

ECV/SELF-

BAKE/CHEF: CB SRL

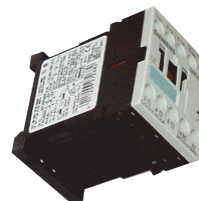

1109065 CONTATT
ORE CB /
CONTACTOR CB

07070006EX: CB

SRL

GPE 24/96P: CB SRL

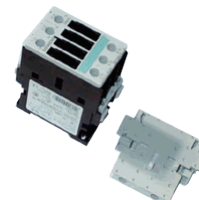

1109020 TELERUT
TORE 9A
LC1D0900M7 / RELAY
9A LC1D0900M7

907190: SILANOS

SRL

907043*:

SILANOS SRL

120444:

COMENDA ALI SPA

E40100023:

GIGA GRANDI
CUCINE

6046043: GIORIK

SPA

00006280:

ELFRAMO SPA

120434:

COMENDA ALI SPA

907096: SILANOS

SRL



1109093 TELERUT.
ABB 12A 24V 50/60HZ
/

CONTACTOR ABB
12A 24V 50/60HZ

120469:

COMENDA ALI SPA



1109095 TELERUT.
ABB 26A 24V 50/60HZ
/
CONTACTOR ABB
26A 24V 50/60HZ
120471:
COMENDA ALI SPA



1109159 TELERUT
TORE 9A/16A 24V
50/60HZ /
CONTACTOR 9A /
16A 24V 50 / 60HZ
DW2000370:
DIHR-ALI SPA



1109111 CONTATT
ORE /
CONTACTOR
57000:
DITTING
MASCHINEN AG



1109113 CONTATT
ORE CA4-9 10 24V
5060HZ /
CONTACTOR CA4-9
10 24V 5060HZ
927037:
ELETTROBAR
927051:
ELETTROBAR
927160:
ELETTROBAR
DIVISIONE DELLA
EUROTEC SRL
927160: MBM
DTC250: COLGED
*: MBM- EUROTEC
SRL - DIV.
COOKING SERVICE



1109115 CONTATT
ORE
QUADRIPOLARE X5
22A /
POWER CONTACTOR
SUPPLY 230V
RESISTEVE LOAD
40A
229037:
ELETTROBAR
DIVISIONE DELLA
EUROTEC SRL
80350ex:
ELETTROBAR
DIVISIONE DELLA
EUROTEC SRL
*:
MBM- EUROTEC SRL
- DIV. COOKING
SERVICE
*:
MBM- EUROTEC SRL
- DIV. COOKING



SERVICE
73350ex:
ELETTROBAR
DIVISIONE DELLA
EUROTEC SRL

1109142 TELERUT
TORE /
CONTACTOR
CON001:
GARBIN
INDUSTRIES SRL



1109070 TELERUT
TORE NP 80 /
CONTACTOR NP 80
9141210:
GRUPPO CIMBALI
SPA



1109076 TELERUT
TORE 20A 230V /
CONTACTOR 20A
230V
LAR65140550:
LAINOX ALI SPA
LAR65140700:
LAINOX ALI SPA
LAR65140700:
OLIS DIVISIONE
DI ALI GROUP SPA
-
R65140550:
LAINOX ALI SPA



termico=1109170

1109078 CONTATT
ORE 230V LASA /
CONTACTOR 230V
LASA
3426230: LASA SRL



1109079 RELAIS
LOVATO MC9 /
RELAY LOVATO MC9
3426100: LASA SRL



1109080 RELAIS
SIEMENS SIRIUS /
RELAY SIEMENS
SIRIUS
3421500: LASA SRL



1109122 TELERUT
TORE 30A
FRIGGITRICE /
POWER
CONTACTOR 30A
34200285:
RANCILIO SPA
LOTUS SPA



1109049 TELERUT
TORE 230V /
CONTACTOR 230V
180024:
MAGISTER
SISTEMA CAFFE'
SRL



1109139 TELERUT
TORE BF.09-10
S.ORANGE /
CONTACTOR BF.09-
10 S.Orange
EN17000:
OEM ALI SPA

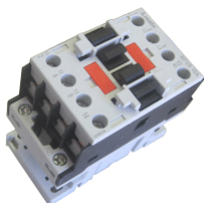

1109145 CONTATT
O AUSILIARI
BGX10.11 /
CONTACT
AUXILIARY
BGX10.11
EN13100:
OEM ALI SPA



1109003 CONTATT
ORE 3TG USC.VITE
220V NC /
CONTACTOR 3TG
220V SCREW
CONNECTION
CECT:
OMNIWASH SRL -
SOCIETA' A SOCIO
UNICO



1109030 CONTATT
ORE 3TG USC.VITE
24V 3TG 1001-1AC2 /
CONTACTOR 3TG
SCREW
CONNECTION 24V
3TG 1001-1AC2
CECT24P:
OMNIWASH SRL -
SOCIETA' A SOCIO
UNICO



1109018 TELERUT
TORE LS07.4.00 /
RELAY LS07.4.00
34200220:
RANCILIO SPA

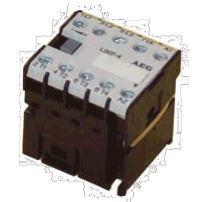

1109074 CONTATT
ORE 230 V. 50/60 HZ /
CONTACTOR 230V
50/60HZ
34200285EX:
RANCILIO SPA
34200293:
RANCILIO SPA
34200260:
RANCILIO SPA
34200285:
RANCILIO SPA



1109148 CONTACT
OR /
CONTACTOR
CM33730739:
SCOTSMAN ICE
SRL

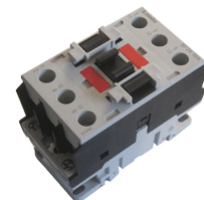

1109019 TELERUT
TORE LS4K 10-OA
220V NO /
RELAY 3TB40 10-OA
220V
907095: SILANOS
SRL
907041: SILANOS
SRL
907043: SILANOS
SRL
34200025:
RANCILIO SPA

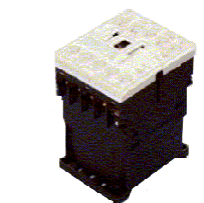

1109123 MINICONT
ATTORE 12A 24VAC /
MINICONTACTOR
12A 24VAC
EE-RA100-
M12NKD3:
VELOX BARCHITTA
S.R.L.



1109017 TELERUT
TORE TIPO MC901
22050 NC / R
ELAY TYPE MC901
22050



1109022 MINICONT
ATTORE 380V 50/6
NC /
MINICONTACTOR
380V 50/6

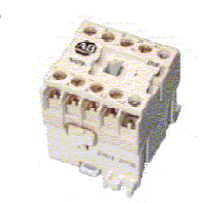

1109041 MINICONT
ATTORE 380V NO /
MINICONTACTOR
380V NO



1115010 COMMUT
ATORE ANGOLARE
A.PO / ANGULAR
COMMUTATOR A.PO
32W2550:
ANGELO PO
GRANDI CUCINE
SPA



1109004 CONTATT
ORE 3TG USC.
FASTON 220V /
CONTACTOR 3TG
220V FASTON
CONNECTION
CECTF:
OMNIWASH SRL -
SOCIETA' A SOCIO
UNICO



1115024 COMMUT
ATORE SELEZ. 4P /
SELECT SWITCH. 4P
32W0980:
ANGELO PO
GRANDI CUCINE
SPA

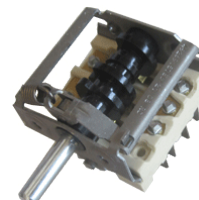

1109067 ZOCCOLO
RELE' UNDECAL
ZKR118 /
UNDECAL RELAY
CLOG ZKR118
GIRR.GAS CE VR-
EV-ESP2: CB SRL



1115025 COMMUT
ATORE ON- OFF-
START /
COMMUTATOR ON-
OFF-START
32W0970:
ANGELO PO
GRANDI CUCINE
SPA

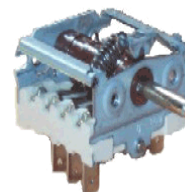

1109144 TEL.BGR0
901A 230V50-60
INT.EST /
TEL.BGR0901A
230V50-60 INT.EST
EN13900:
OEM ALI SPA



1115062 SELETTOR
E 3 CAMES
ON/OFF/START /
OPERATION SWITCH
ON/OFF 3-POLES
CONNECTION FLAT
PLUG
**3041660: ANGELO
PO**
048271:
ELECTROLUX

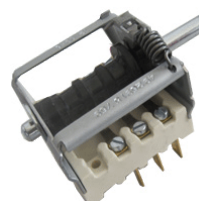

1109137 TELERUT
TORE 4NO 24A(R) /
RELAY 4NO 24A(R)
46105100:
MODULAR SPA



1115014 COMMUT
ATORE 5 POS.
32W1050 A.PO /
COMMUTATOR 5
POSITIONS 32W1050
A.PO
**32W1050: ANGELO
PO**

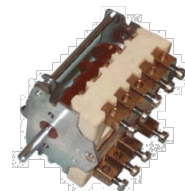

1109069 RELE'
TERMICO /
RELAY
GP E/G GV: CB SRL



1105156 COMMUT
ATORE 5 POSIZIONI
A. PO / SWITCH 5
POSITIONS A.PO
32W0520:
ANGELO PO
GRANDI CUCINE
SPA

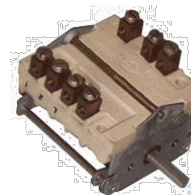

1109068 SUPPORT
O RELE' /
RELAY-HOLDER
**GIRR.GAS -GV: CB
SRL**



1105164 COMMUT
ATORE 5
POS.A.PO3260 /
SWITCH 5 POSITIONS
3260 A.PO
32W3260:
ANGELO PO
GRANDI CUCINE
SPA

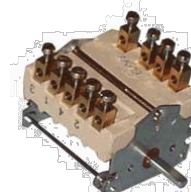

S&P Cooking Catalogue 2017

1115050 COMMUT
ATORE 7 POSIZIONI /
7 POSITIONS
COMMUTATOR
32W0760:
ANGELO PO
0101423:
SILKO ALI SPA
BN6A045500: OLIS
1616100: MARENO
RTC700078:
EUROTEC SRL -
DIV. COOKING
SERVICE MBM
66100200:
MODULAR SPA

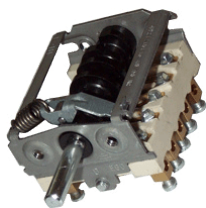

1115071 COMMUT
ATORE 3 POSIZIONI /
COMMUTATOR 3
POSITIONS
901727:
SILANOS SRL

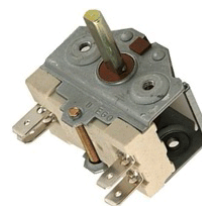

1115084 COMMUT
ATORE 2 POSIZIONI /
SWITCH 2 POSITIONS
0109057:
SILKO ALI SPA
1037035700:
MARENO
INDUSTRIE
RTC900110: MBM



1115037 COMM.P.E
.0+6 E4F4KW
4327232000 /
OPERATION SWITCH
7-TACTS WITH
SIGNAL CONTACTS
32W2920:
ANGELO PO
GRANDI CUCINE
SPA
0A2022:
ELECTROLUX
PROFESSIONAL
S.P.A.
1937800:
MARENO
INDUSTRIE
RTC800151: MBM
K24014: A.T.A. SRL
96100000:
MODULAR

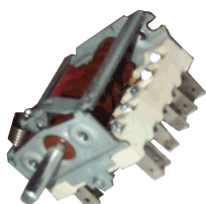

1115007 COMMUT
ATORE TAVOLA
CALDA 54375 /
DISH-WARMER
COMMUTATOR 54375
054375:
ELECTROLUX
PROFESSIONAL
S.P.A.
52002115: GICO
SPA
BN6A046000:
OLIS DIVISIONE
DI ALI GROUP SPA
-
MA1037313200:
MARENO
INDUSTRIE ALI
SPA
6030015: GIORIK
SPA

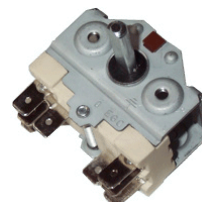

= 4117612

1105160 COMMUT
ATORE 5 POSIZ. 1500
A.PO / SWITCH 5
POSITIONS 1500 A.PO
32W1500:
ANGELO PO
GRANDI CUCINE
SPA

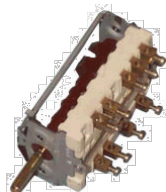

1105157 COMMUT
ATORE 4 POSIZIONI
A.PO / SWITCH 4
POSITIONS A.PO
32W1440:
ANGELO PO
GRANDI CUCINE
SPA

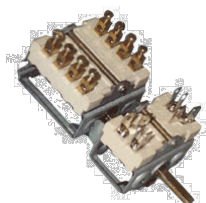

1115046 COMMUT
ATORE 0-I /
COMMUTATOR 0-I
814040:
EMMEPI GRANDI
CUCINE S.R.L.
RTC700212:
EUROTEC SRL -
DIV. COOKING
SERVICE MBM



1105406 "INTERRU
TORE BIPOLARE;
16A 250V" /
SELECTOR SWITCH
0-1 POSITIONS
41826630290:
POLARIS/BARON
ALI S.P.A.
0A2036:
ELECTROLUX
PROFESSIONAL
S.P.A.



8 contatti

1115082 COMMUT
ATORE 0-1-2 /
SWITCH 0-1-2
0A2227:
ELECTROLUX
PROFESSIONAL
S.P.A.
PR10132:
FABA SRL

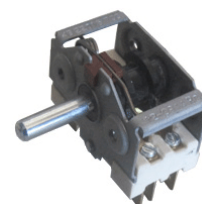

1115036 "SELETTOR
RE: 3 CAMMES" /
COMMUTATOR 3
CONTACTS
048270:
ELECTROLUX
PROFESSIONAL
S.P.A.

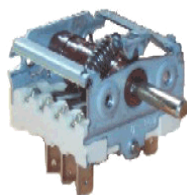

1115044 INTERRUT
TORE /
SWITCH
0A2241:
ELECTROLUX
PROFESSIONAL
S.P.A.

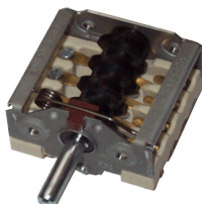

1115039 COMMUT
ATORE 0-I /
OPERATION SWITCH
0-I
6030019: GIORIK
SPA
0108026:
SILKO ALI SPA
808052:
EMMEPI GRANDI
CUCINE S.R.L.

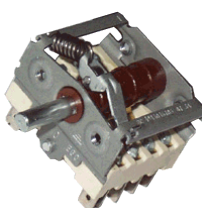

1115092 COMMUT
ATORE EGO
49.42015.00 / SWITCH
EGO 49.42015.00
MA1230100:
MARENO
INDUSTRIE ALI
SPA

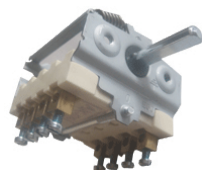

4117880 KIT
COMM.+C.FGMD067 /
KIT COMMUTATOR +
CFG.MD067
RIC0004532:
EUROTEC SRL -
DIV. COOKING
SERVICE MBM

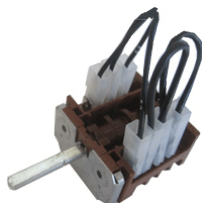

1105249 COMM.FC
VM.4925815703 /
OPERATION SWITCH
5-TACTS
RTFOC00143:
EUROTEC SRL -
DIV. COOKING
SERVICE MBM

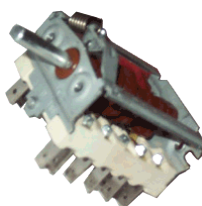

1115008 COMMUT
ATORE PIASTRA
FABA 4CONT /
PLATE
COMMUTATOR
FABA 4 CONTACTS
PR10007: FABA SRL
9564: DIHR-ALI
SPA
*****:
RANCILIO SPA

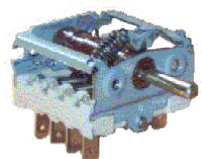

1115055 INTERRUT
TORE EGO 494101530
CTR /
COMMUTATOR
SWITCH EGO
494101530
66100000:
MODULAR SPA
710300:
MARENO
INDUSTRIE



1115086 COMMUT
ATORE 4 POSIZIONI /
COMMUTATOR 4
POSITIONS
BN6A001412:
OLIS DIVISIONE
DI ALI GROUP SPA
-
66103700:
MODULAR SPA
35050100:
BERTO'S SPA



1115078 COMMUT
ATORE 4 POSIZIONI
0-1-2-3 /
COMMUTATOR 4
POSITIONS 0-1-2-3



1115057 OPERATIO
N SWITCH /
OPERATION SWITCH
R65080010:
LAINOX ALI SPA
6030018: GIORIK
SPA
0281: FOINOX
S.P.A.
808806: EMMEPI
057934:
ELECTROLUX
2709600EX:
MARENO
INDUSTRIE ALI
SPA



1115085 COMMUT
ATORE 0-1 0-1 3 POLI
4 POSIZIONI /
OPERATION SWITCH
4-POSITION
0101400:
SILKO ALI SPA
52003432: GICO
SPA
MA790700:
MARENO
INDUSTRIE ALI
SPA
RTCP900036:
EUROTEC SRL -
DIV. COOKING
SERVICE MBM

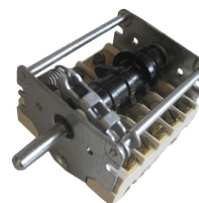

S&P Cooking Catalogue 2017

1115030 COMMUT
ATORE SILKO /
COMMUTATOR
SILKO
0101399:
SILKO ALI SPA

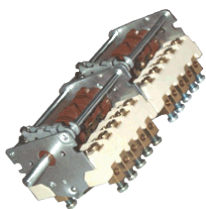

1115032 COMMUT
ATORE A CAMME 0-
1-2-3 /
COMMUTATOR 0-1-2-
3

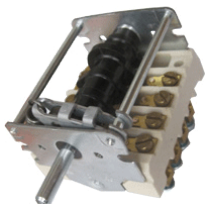

1105202 COMMUT
ATORE CB /
COMMUTATOR CB
ECV/SELF: CB SRL



1115063 COMMUT
ATORE 2 POSIZIONI /
COMMUTATOR 2
POSITIONS



1115088 COMMUT
ATORE BIP.CELLE /
BIPOLAR
COMMUTATOR
EH03000:
OEM ALI SPA



1115053 COMMUT
ATORE 5 POS /
5 POSITIONS
COMMUTATOR
048829:
ELECTROLUX
PROFESSIONAL
S.P.A.

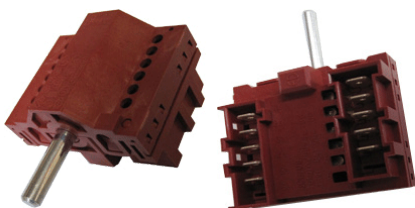

1115059 COMMUT
ATORE 4 POSIZIONI /
COMMUTATOR 4
POSITIONS
059544:
ELECTROLUX
PROFESSIONAL
S.P.A.



1115115 COMMUT
ATORE A CAMME 4
POSIZIONI DI
COMANDO 5NO 0-1-
2-3 16A /
COMMUTATOR 4
POSITIONS 5NO 0-1-
2-3 16A

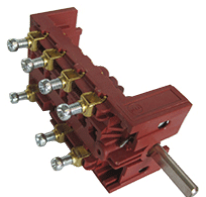

1115100 COMMUT
ATORE VEF0V7
4623966950 /
CHANGEOVER
SWITCH VEF0V7
4623966950
RTC700454:
EUROTEC SRL -
DIV. COOKING
SERVICE MBM



1115013 COMMUT
ATORE X GRILL
ROTANTE /
ROTATING GRILL
COMMUTATOR
PR4G038: FABA SRL

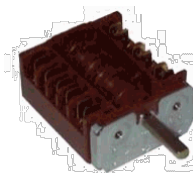

1109077 SELETTOR
E 11CH PER LC40AD /
SELECTOR 11CH PER
LC40AD
3168120: LASA SRL
1037303200:
MARENO
INDUSTRIE ALI
SPA



1115049 COMMUT
ATORE 7 POS / 7
POSITIONS
COMMUTATOR
004741:
ELECTROLUX
PROFESSIONAL
S.P.A.



1115072 COMMUT
ATORE 5 POSIZIONI /
COMMUTATOR 5
POSITIONS
R65080020:
LAINOX ALI SPA

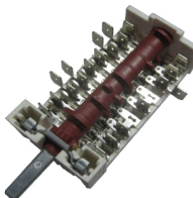

1115077 COMMUT
ATORE 7 POSIZIONI /
COMMUTATOR 7
POSITIONS
K7MCU10FV-10FVP-
15FV-15FVP:
A.T.A. SRL

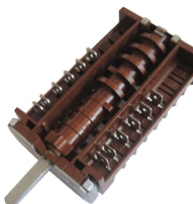

1115006 COMMUT
ATORE 6 POS.
ZANUSSI /
OPERATION SWITCH
6 POLES ZANUSSI
0E5222:
ELECTROLUX
PROFESSIONAL
S.P.A.

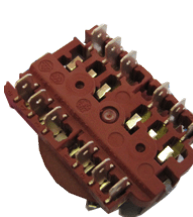

S&P Cooking Catalogue 2017

1115035 COMM.F.G
4SFE6 4623966811 /
OUTER SWITCH
RTC0600185:
EUROTEC SRL -
DIV. COOKING
SERVICE MBM

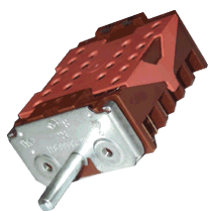

1112311 TIMER
MECCANICO 15' T125
/
MECHANICAL TIMER
15 'T125
6991:
ARISTARCO
KASTEL SPA



1115064 COMMUT
ATORE /
COMMUTATOR

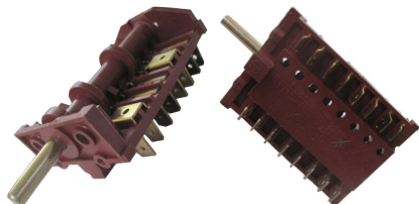

1112225 TIMER
PER
MACINADOSATORE
6 MINUTI /
TIMER 6 MINUTES



Knob= 3108336

1115107 ENCODER
SCHEDA /
ENCODER CARD
LAR65301450:
LAINOX ALI SPA
LAR65301450:
OLIS



1112167 TIMER
MECCANICO CB /
TIMER CB
GOLOSO 4 -
BAKE/CHEF: CB SRL
09030160: CB SRL



time 144 min,
2 cammes

1110027 MANOME
TRO RADIALE D.80 A
GLIC. /
RADIAL
MANOMETER D.80



1110014 MANOME
TRO 1 BAR A.PO /
MANOMETER 1 BAR
A.PO
32V0940:
ANGELO PO
GRANDI CUCINE
SPA



1110025 MAN.
RAD. BP D.63 60MB /
MANOMETER BP
D.63 60MB



1110032 MANOME
TRO RADIALE D.63 A
GLIC. /
RADIAL
MANOMETER D.63



1112011 TIMER TS
+ MANOPOLA /
TIMER TS + KNOB
222001:
ELETTROBAR
DIVISIONE DELLA
EUROTEC SRL
1112011: CB SRL
907055:
SILANOS SRL
537001100:
LOTUS SPA
10705218:
RANCILIO SPA
Z400E304:
S.V. ITALIA SRL
1112011: UNOX
DW8030:
DIHR-ALI SPA
PR40014*: FABA SRL



time 15'

1112162 TIMER
TS15' ALBERO
BIFRESATO /
TIMER TS15'

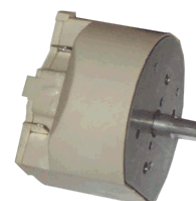

Knob=3108396,
time 15'

1112163 TIMER 15'
TS BIFRESATO
+MANOPOLA /
TIMER 15' X
TOASTER + KNOB
PR40014: FABA SRL



time 15'

1112088 TIMER
FORNO 60' CON
SUONERIA +
MANOPOLA /
OVEN TIMER 60'
WITH BELL + KNOB
056485:
ELECTROLUX
PROFESSIONAL
S.P.A.



time 60'

1112282 "TIMER
TF024 F02 741 6""
230/400" /
"TIMER TF024 F02 741
6"" 230/400"
EC03900:
OEM ALI SPA

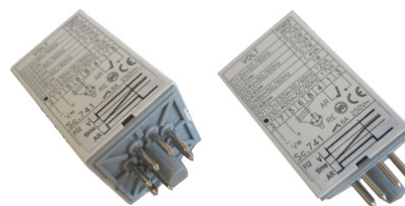

1112089 TIMER
PER FORNO 60' +
MANOPOLA SENZA
SUONERIA /
OVEN TIMER 60' +
KNOB

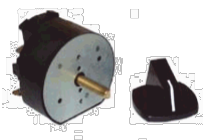

time 60'

1112229 TIMER 72"
/
"TIMER 72""



1112130 TIMER 120
-POS/MAN.C/
SUONERIA+MANOPO
LA /
TIMER 120 POS/MAN
WITH BELL+KNOB



4 contatti, time 120'

1112146 TEMPORIZ
ZATORE 0-120" /
TIMER 0-120"
32Z9630:
ANGELO PO
GRANDI CUCINE
SPA



1112257 TIMER
FORNO 120' /
OVEN TIMER 120'



6 contatti

1112165 TEMPORIZ
ZATORE
ELETTROMECCANIC
O CB /
TIMER CB
GVM: CB SRL



1112268 TEMPORIZ
ZATORE AD
OROLOGIO IMP /
MECHANICAL
TIMER
EC02800:
OEM ALI SPA



1112043 TEMPORIZ
ZATORE X FORNO
055366 /
OVEN TIMER 055366
055366 :
ELECTROLUX
PROFESSIONAL
S.P.A.
OCA557:
ELECTROLUX
PROFESSIONAL
S.P.A.

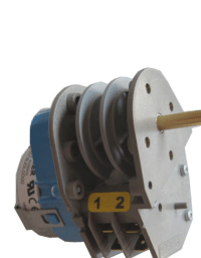

1112153 TIMER
ELETTRONICO /
ELECTRONIC TIMER
32Z8230:
ANGELO PO
GRANDI CUCINE
SPA



1112170 "TIMER;
120 MIN, 230V 50HZ" /
""TIMER; 120 MIN,
230V 50HZ""
OC8755:
ELECTROLUX
PROFESSIONAL
S.P.A.



1112280 TIMER
TF24/815 F.02
115/230VAC /
TIMER TF24/815 F.02
115/230VAC
EC05100:
OEM ALI SPA



BN6A047080:
OLIS DIVISIONE
DI ALI GROUP SPA -
LAR65090110:
LAINOX ALI SPA
LAR65090200:
LAINOX ALI SPA
003833:
ELECTROLUX
PROFESSIONAL
S.P.A.

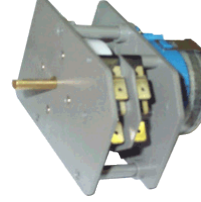

120 min, 3 camme

1112312 PROGRAM
MATORE P25 /
TIMER P25



3 cammes

1112336 TEMPORIZ
ZATORE 120' MS65
6935A /
TIMER 120' MS65
6935A
6032059:
GIORIK SPA

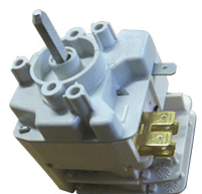

120', 2 cammes

1112256 INVERSOR
E CICLICO 8' /
TIMER 8'
BN3102320:
OLIS DIVISIONE
DI ALI GROUP SPA -
R65090190:
LAINOX ALI SPA
LAR65090190:
LAINOX ALI SPA
BN3102320:
OLIS DIVISIONE
DI ALI GROUP SPA -

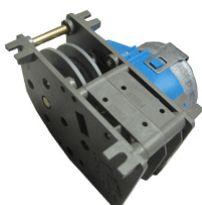

time 8', 2 cammes

1112316 TIMER
FORNO P345 2
CAMME 230V 50/60HZ
144' CON SUONERIA /
LAR65090020:
LAINOX ALI SPA
50304580EX:
LAINOX ALI SPA

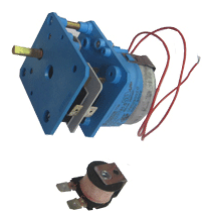

=2 cammes, =time
144'

1107217 MAGNET
E /
MAGNET
59000351:
GIORIK SPA



1107137 LEVA
LUNGA CON
ROTELLA X(058) /
LEVER WITH ROLL
FOR MICROSWITCH
1107058



1107042 MICROIN
TERRUTTORE
AH715378 /
MICRO SWITCH
AH715378
32W4240:
ANGELO PO
GRANDI CUCINE
SPA

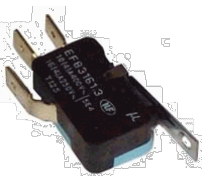

50123*: CEADO SRL
DW10704:
DIHR-ALI SPA
10704: DIHR-ALI
SPA

1107082 MICRO
DEVIATORE 16A
C/LEVA /
MICRO-SWITCH 16A
PASSPORT1040,
GL1040, GL1240:
ARISTARCO
KASTEL
C00061023:
MACAP SRL

808053: EMMEPI
862311: OFFCAR
1037111300:
SILKO ALI SPA
25190007:
ELFRAMO SPA
6043085: GIORIK
SPA
30610:
SISTEMA PROJECT
MA1037111300:
SILKO ALI SPA
MA1037111300:
MARENO
INDUSTRIE
01035: FABAR SRL

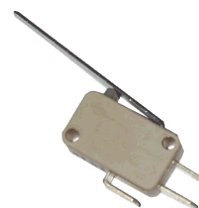

1107126 MICRO
16A NO STRUTTURA
METALLICA 23700 /
MICRO-SWITCH 16A
23700
23700:
BREMA ICE
MAKERS SPA



1107077 MICROIN
TERRUTTORE CON
TASTO ROSSO /
MICRO-SWITCH
WITH RED PUSH-
BUTTON
GIRARROSTI: CB
SRL
0101184:
SILKO ALI SPA



1107026 MICROIN
TERRUTTORE DI
SICUREZZA /
SAFETY MICRO-
SWITCH
PR70011: FABA SRL



1107078 ASSIEME
MICRO PORTA P80 /
MICRO-DOOR P80
984759000:
GRUPPO CIMBALI
SPA
9131735:
GRUPPO CIMBALI
SPA

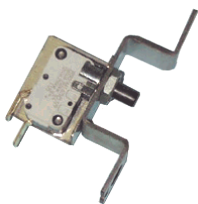

1107128 MICROIN
TERRUTTORE DI
SICUREZZA 3
CONTATTI 16A /
SAFETY MICRO-
SWITCH 3
CONTACTS
4818135868:
FAEMA
120313:
COMENDA ALI SPA
532020310: FAEMA
532020300: FAEMA
1519: FOINOX
S.P.A.
539502: GICO SPA
LAR65260530:
LAINOX ALI SPA
50304530:
LAINOX ALI SPA



1107178 MICRO
MOD. N16 CON
PULSANTE /
MICROSWITCH N16
WITH PUSH BUTTON
120304:
COMENDA ALI SPA



1107035 ASS.
MICRO TELE.
DOPPIO SICUREZZA
PORTA /
MICRO SWITCH
WITH PRESSURE PIN
2651:
ARISTARCO
KASTEL SPA
PASSPORT45.30/50
.32/50.35/55.40,MA
STER22,PROJET28E
/EM,ALISEO:
ARISTARCO
KASTEL SPA



1107215 MICRO
COMPLETO AE35 /
MICRO COMPLETE
AE35
3528ex:
ARISTARCO
KASTEL SPA
12271:
ARISTARCO
KASTEL SPA



1107222 MICROIN
TERRUTTORE
BIPOLARE M10X0.75
/
BIPOLAR
MICROSWITCH
M10X0.75
33059400:
BERTO'S SPA



1107016 MICRO
INTERRUTTORE
Z15GO OMRON /
MICRO-SWITCH
Z15GO OMRON
65260540:
LAINOX ALI SPA
LAR65260540:
LAINOX ALI SPA
LAR65260540:
OLIS DIVISIONE
DI ALI GROUP SPA
-



1107060 MICRODE
VIATORE A.PO /
MICRO-SWITCH
A.PO
32W0960:
ANGELO PO
GRANDI CUCINE
SPA



1107189 MICROIN
TER.PULS.FILETT+R
OT.BM2 /
MICROSWITCH
WITH BUTTON
EG03200:
OEM ALI SPA



1107190 MICRO
PULS.FIL.C/ROT.TRA
SV.BM2 /
MICROSWITCH
WITH BUTTON
EG03700:
OEM ALI SPA



1107091 MICRODE
VIATORE 15A PRESS.
A LEVA /
MICRO-SWITCH 15A



1107092 MICRODE
VIATORE LEVA
PIANA CONT. /
MICRO-SWITCH

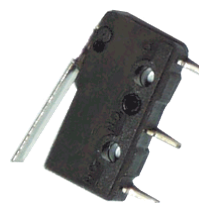

1107093 ATTUATORE A LEVA SAGOMATA / MICRO-SWITCH

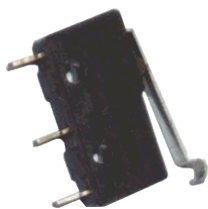

1107094 MICRODEVIATORE A PULSANTE CONTINUO / MICRO-SWITCH WITH PUSH-BUTTON



1107095 ATTUATORE A LEVA CON ROTELLA CONT. / MICRO-SWITCH WITH SMALL WHEEL

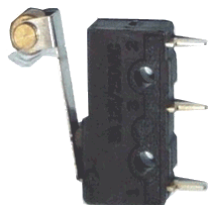

1107096 MICRODEVIATORE LEVA PIANA 3A 250V TERM. CORSA / MICRO-SWITCH 3A 250V



1107097 MICRODEVIATORE LEVA SAGOM. CTERM. PER C.S3A UL / MICRO-SWITCH 3A UL

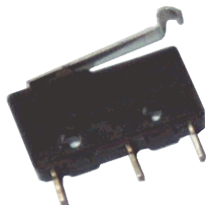

1107098 MICRODEVIATORE A PULSANTE TERM PER C.S. 3 A UL / MICRO-SWITCH 3A UL

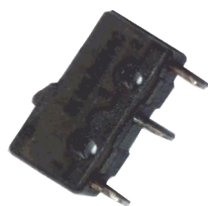

1107099 MICRODEVIATORE C/ROTELLA TERM 3A / MICRO-SWITCH WITH SMALL WHEEL 3A



1107100 ATTUATORE A LEVA FASTON 4,8 LEVA 52MM / MICRO-SWITCH FASTON 4,8 52mm



1107101 MICROINTERRUTTORE A LEVA C.ROTELLA FASTON 4,8 / MICRO-SWITCH WITH SMALL WHEEL FASTON 4,8



1107046 MICROCONTATTO MAGNETICO REED / MICROSWITCH MAGNETIC REED

DW10778:
DIHR-ALI SPA
695001: GICO SPA



1107238 INTERRUTTORE MAGNETICO CPL / MAGNETIC SWITCH Complet

088578:
ELECTROLUX PROFESSIONAL S.P.A.



1107223 MICROINTERRUTTORE + ASTINA E CAVO / MICRO SWITCH + ROD AND CABLE

059565:
ELECTROLUX PROFESSIONAL S.P.A.



1107132 MAGNETE M302AFO / MAGNET M302AFO

217003:
ELETTROBAR DIVISIONE DELLA EUROTEC SRL



1107074 SENSORE MAGNETICO / TEMPERATURE PROBE

9131616:
GRUPPO CIMBALI SPA
984159000:
GRUPPO CIMBALI SPA



1107171 MICROINTERRUTTORE PORTA COMPLETO / DOOR MAGNETIC SWITCH

R65265100:
LAINOX ALI SPA
LAR65265100:
LAINOX ALI SPA



S&P Cooking Catalogue 2017

1107020 MICROM
AGNETICO E510 1V
DA+M360 /
MAGNETIC MICRO-
SWITCH E510 1V
DA+M360

995405: LAINOX

ALI

MA5169100:

MARENO

25110113: ELFRAMO

211002ex:

ELETTROBAR

80871:

ELETTROBAR

FR995405: LAINOX

FR995405: SILKO

ALI



4109071 SPARTIFI
AMMA AMBACH Ø
90MM /
Burner cap AMBACH
Ø 90MM

5018705710:

AMBACH



Ø=90mm

4109113 SPARTIFI
AMMA AMBACH D
125 /
FLAME SPREADER
Ø125 AMBACH

5018705859:

AMBACH



Ø=125mm

1107152 CONSENS
O ELETTICO CON
CAVI /
MICRO SWITCH

6010054: GIORIK

SPA

054539:

ELECTROLUX

PROFESSIONAL

S.P.A.

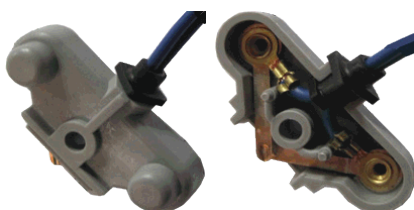

4109105 SPARTIFI
AMMA AMBACH
D.125 APERTO /
Burner cap OPEN
AMBACH D.125

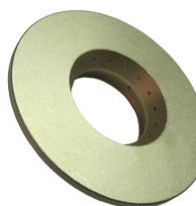

Ø= 125mm

1107247 SENSORE
MAGNETICO /
MAGNETIC SENSOR

049621:

ELECTROLUX

PROFESSIONAL

S.P.A.



4109111 SPARTIFI
AMMA Ø80 4KW /
FLEAME SPREADER
Ø80 4KW

3057610:

ANGELO PO

GRANDI CUCINE

SPA



X



80mm

Ø=80mm, X=4111200

1105387 SWITCH
FAN CYCLE /
SWITCH FAN CYCLE

IOM904109601:

SCOTSMAN ICE

SRL



4109014 SPARTIFI
AMMA Ø 90 IN
GHISA A. PO /
CAST IRON FLAME
SPREADER D. 90
A.PO

34A1123:

ANGELO PO

GRANDI CUCINE

SPA



X



Ø
90 mm

Y



Ø
90 mm

Ø=90mm, X= 4111002,
Y= 4111057

1105372 POTENZI
OM.1 MOHM
LIN.S.I.0,25 /
POTENTIOMETER

HE09200:

OEM ALI SPA



4109019 SPARTIFI
AMMA D. 110 A.PO /
FLAME SPREADER D.
110 A.PO

34A1133:

ANGELO PO

GRANDI CUCINE

SPA



X



Ø
110 mm

X= 4111023, Ø=110mm

1107143 *AT.MAG
NETICO GF45CE /
CONNECTION,
MAGNETIC GF45/CE

RIC0001384:

MBM- EUROTEC

SRL - DIV.

COOKING SERVICE



4109101 SPARTIFI
AMMA D.110MM
A.PO /
CAP BURNER
D.110MM A.PO

3019390:

ANGELO PO

GRANDI CUCINE

SPA



X



Ø
110 mm

X=4111179, Ø=110 mm

S&P Cooking Catalogue 2017

Ø=130mm, X=4109102

4109032 SPARTIFI
AMMA D. 120mm
GHISA /
FLAME SPREADER
D.120mm
34A0540:
ANGELO PO
GRANDI CUCINE
SPA

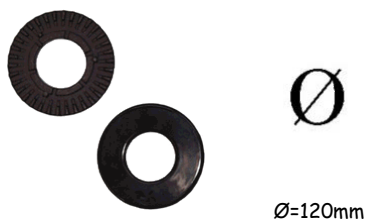

Ø=120mm

4111052 BRUCIAT
ORE A.PO D.140 /
BURNER D. 140 A.PO
34A1401:
ANGELO PO
GRANDI CUCINE
SPA



X



Ø
140mm

Ø=140mm, X=4109001

4109102 SPARTIFI
AMMA D. 130 10Kw /
FLAME SPREADER Ø
130 mm 10KW
3019370:
ANGELO PO
GRANDI CUCINE
SPA



X



Ø
130mm

Ø=130mm, X=4111146

4111201 VENTURI
§10.5X140 /
VENTURI §10.5X140
3057620:
ANGELO PO
GRANDI CUCINE
SPA



4109001 SPARTIFI
AMMA D. 140 IN
GHISA A.PO /
CAST IRON FLAME
SPREADER D. 140
A.PO
34A1141:
ANGELO PO
GRANDI CUCINE
SPA



X



Ø
140mm

Ø=140mm, X=4111052

4111202 SUPPORT
O BRUCIATORE /
BURNER SUPPORT
34A2071:
ANGELO PO
GRANDI CUCINE
SPA



4111200 BRUCIAT
ORE Ø80 4KW /
BURNER Ø80 4KW
3057600:
ANGELO PO
GRANDI CUCINE
SPA



X



Ø
80mm

Ø=80mm, X=4109111

4111026 SUPPORT
O BRUCIATORE A.PO
/
BURNER SUPPORT
A.PO
36D2771:
ANGELO PO
GRANDI CUCINE
SPA

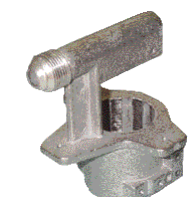

4111057 BRUCIAT
ORE D. 90 A.PO /
BURNER D. 90 A.PO
34A1100:
ANGELO PO
GRANDI CUCINE
SPA



X



Ø
90 mm

X= 4109014, Ø=90mm

4109112 SPARTIFI
AMMA BRUCIATORE
D85 S90 /
FLAME SPREADER
D85 S90
K25004: A.T.A. SRL



X



Ø
85 mm

Ø=85mm, X=4111209

4111179 BRUCIAT
ORE §110 7Kw A.PO /
BURNER § 110 7Kw
A.PO
3019380:
ANGELO PO
GRANDI CUCINE
SPA



X



Ø
110 mm

X=4109101, Ø=110 mm

4109107 SPARTIFI
AMMA BRUCIATORE
D110 S90 /
BURNER CAP D110 -
S90 ATA
K25005: A.T.A. SRL



X



Ø

Ø=110mm, X= 4111187

4111146 BRUCIAT
ORE Ø130 10KW /
BURNER Ø130 10 KW
3019360:
ANGELO PO
GRANDI CUCINE
SPA



X



Ø
130mm

4111209 CORPO
BRUCIATORE D85
S90 /
BURNER D85 S90
K25001: A.T.A. SRL



X



Ø
85 mm

Ø=85mm, X=4109112

S&P Cooking Catalogue 2017

4111187 CORPO
BRUCIATORE D110 /
BODY BURNER D110
K00073: A.T.A. SRL



4111188 VENTURI
BRUCIATORE D110
S90 /
VENTURI BURNER
D110 S90
K25008: A.T.A. SRL

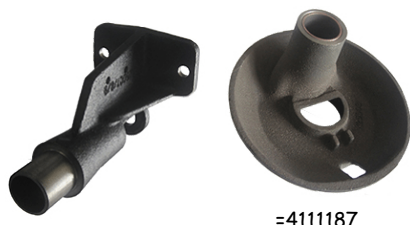

4111189 BOCCOLA
REGOLAZIONE ARIA
FA /
BUSH AIR
ADJUSTMENT FA
K26022: A.T.A. SRL



4109096 COPERCHI
O PER BRUCIATORE
SPARTIFIAMMA
BERTO'S /
BURNER CAP
BERTO'S
31281300:
BERTO'S SPA

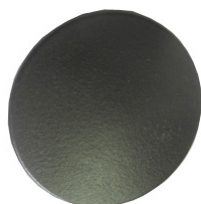

4109097 ANELLO
SPARTIFIAMMA DEL
BRUCIATORE UR /
BURNER RING
BERTO'S
31280600:
BERTO'S SPA



4111163 SUPPORT
O BRUCIATORE 3,6
KW /
BURNER HEAD 3,6
KW BERTO'S
31280500:
BERTO'S SPA



4111172 SUPPORT
O BRUCIATORE /
BURNER SUPPORT
31280200:
BERTO'S SPA



4111164 COPPA
PER BRUCIATORE
TC /
BURNER LOWER
PART BERTO'S
35280100:
BERTO'S SPA

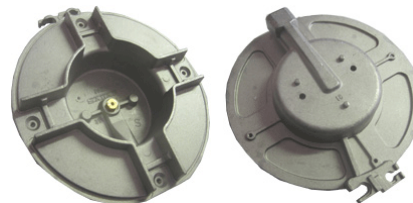

4109002 SPARTIFI
AMMA MBM TIPO
B/DIN /
FLAME SPREADER
MBM TYPE B/DIN
GRCU800001:
MBM- EUROTEC SRL
- DIV. COOKING
SERVICE

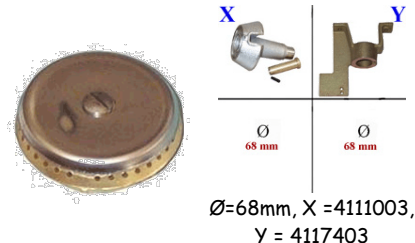

4109003 SPARTIFI
AMMA MBM 5000 /
FLAME SPREADER
MBM 5000
GRCU700002:
MBM- EUROTEC SRL
806123:
EMMEPI GRANDI
CUCINE S.R.L.

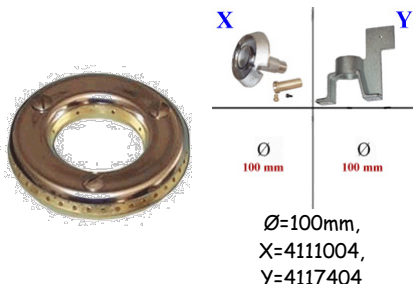

4109004 SPARTIFI
AMMA MBM 7000 /
FLAME SPREADER
MBM 7000
GRCU700003:
MBM- EUROTEC SRL
- DIV. COOKING
SERVICE



4109008 SPARTIFI
AMMA ZANUSSI
002442 /
FLAME SPREADER
ZANUSSI 002442
002442:
ELECTROLUX
PROFESSIONAL
S.P.A.

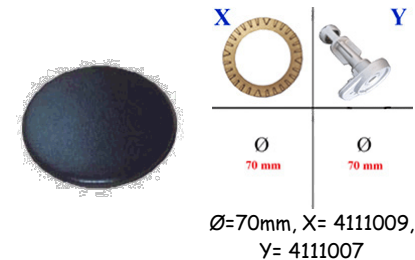

4109048 SPARTIFI
AMMA D. 100 /
FLAME SPREADER D.
100
002443:
ELECTROLUX
PROFESSIONAL
S.P.A.



S&P Cooking Catalogue 2017

4111009 CORONA
BRUCIATORE
ZANUSSI 056747 /
BURNER CROWN
ZANUSSI 056747
056747:
ELECTROLUX
PROFESSIONAL
S.P.A.

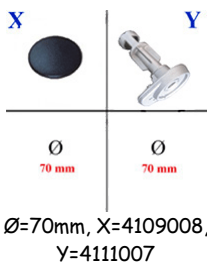

4109012 SPARTIFI
AMMA D. 122 058187 /
FLAME SPREADER
D. 122 058187
058187:
ELECTROLUX
PROFESSIONAL
S.P.A.



4111012 CORONA
BRUCIATORE D. 100
056748 /
BURNER CROWN D.
100 056748
056748:ELECTROLUX
X

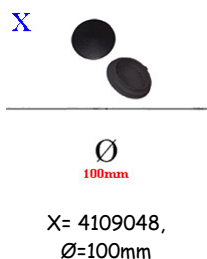

4111106 TESTA
BRUCIATORE; DIA 84
MM /
BURNER HEAD D.
84MM
002461:
ELECTROLUX
PROFESSIONAL
S.P.A.

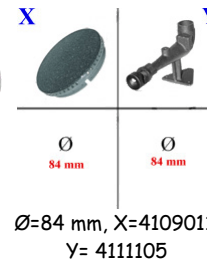

4111007 BRUCIAT
ORE ZANUSSI 054091
/
BURNER HEAD
ZANUSSI 054091
054091:
ELECTROLUX
PROFESSIONAL
S.P.A.

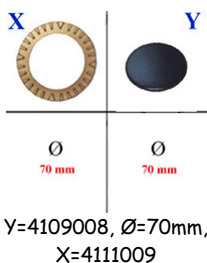

4111107 TESTA
BRUCIATORE; DIA
103 MM /
BURNER HEAD D.
103MM
002462:
ELECTROLUX
PROFESSIONAL
S.P.A.

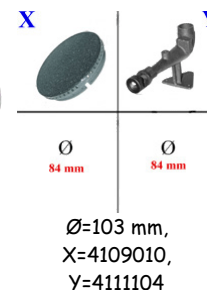

4111155 "BRUCIAT
ORE; DIA 100" /
BURNER HEAD D.
100"
054092:
ELECTROLUX
PROFESSIONAL
S.P.A.



4111108 TESTA
BRUCIATORE; DIA
123 MM /
BURNER HEAD D.
123MM
002463:
ELECTROLUX
PROFESSIONAL
S.P.A.

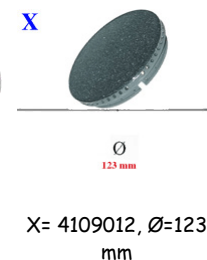

4109011 SPARTIFI
AMMA D. 83 058185 /
FLAME SPREADER D.
83 058185
052122:
ELECTROLUX
PROFESSIONAL
S.P.A.
058185:
ELECTROLUX



4111015 BRUCIAT
ORE PIANO
COTTURA 058182
D.83mm /
BURNER ZANUSSI
058182
058182:
ELECTROLUX
PROFESSIONAL
S.P.A.

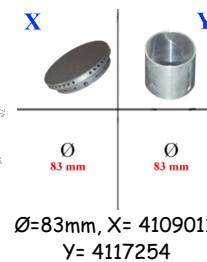

4109010 SPARTIFI
AMMA D. 102 058186 /
FLAME SPREADER D.
102 058186
058186:
ELECTROLUX
PROFESSIONAL
052123:
ELECTROLUX
PROFESSIONAL
S.P.A.



4111019 BRUCIAT
ORE D. 103 58183 /
BURNER D. 103 58183
058183:
ELECTROLUX
PROFESSIONAL
S.P.A.

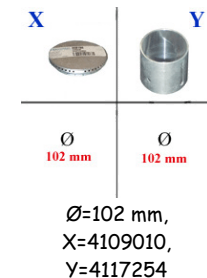

S&P Cooking Catalogue 2017

4111016 BRUCIAT
ORE D. 122 058184 /
BURNER D. 1200
058184
058184:
ELECTROLUX
PROFESSIONAL
S.P.A.

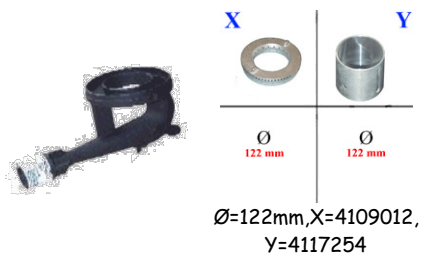

Ø=122mm, X=4109012,
Y=4117254

4109064 SPARTIFI
AMMA DIA 100 MM /
FLAME SPREADER
100MM
OC0128:
ELECTROLUX
PROFESSIONAL
S.P.A.



Ø=100 mm

4111105 CORPO
BRUCIATORE; DIA 83
/
BURNER D. 83
002458:
ELECTROLUX
PROFESSIONAL
S.P.A.

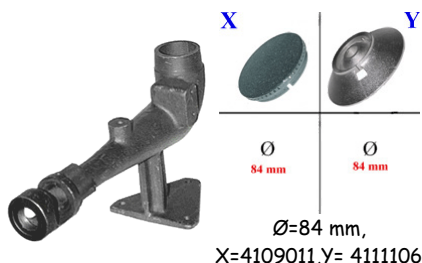

Ø=84 mm,
X=4109011, Y= 4111106

4111158 "CORPO
BRUCIATORE; DIA 60
MM" /
BURNER BODY ø 60
mm 6Kw
OC0127:
ELECTROLUX
PROFESSIONAL
S.P.A.



Ø=60 mm

4111104 CORPO
BRUCIATORE; DIA
103 / BURNER D. 103
002459:
ELECTROLUX
PROFESSIONAL
S.P.A.

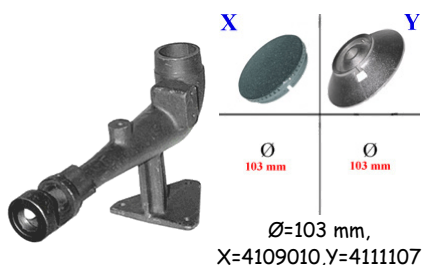

Ø=103 mm,
X=4109010, Y=4111107

4111157 "CORPO
BRUCIATORE; ø 100
MM" /
BURNER BODY ø 100
mm 10KW
OC0126:
ELECTROLUX
PROFESSIONAL
S.P.A.

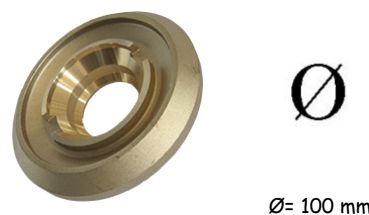

Ø= 100 mm

4111031 CORPO
BRUCIATORE 002460
d.123 /
BURNER 002460
002460:
ELECTROLUX
PROFESSIONAL
S.P.A.



Ø=123 mm, X=
4109012, Y= 4111108

4111191 "BRUCIAT
ORE VENTURI; 6 KW"
/
VENTURI F/FLAME
SPREADER 60 mm
6kW
OC0125:
ELECTROLUX
PROFESSIONAL
S.P.A.



4111190 "BRUCIAT
ORE VENTURI; 10
KW" /
VENTURI F/FLAME
SPREADER 100 mm
10kW
OC0133:
ELECTROLUX
PROFESSIONAL
S.P.A.



4109009 SPARTIFI
AMMA
TUTTAPIASTRA
052377 /
FLAME SPREADER
052377
052377:
ELECTROLUX
PROFESSIONAL
S.P.A.

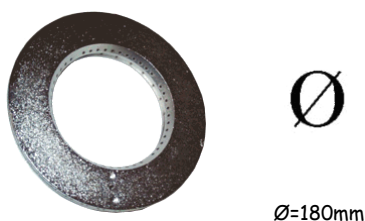

Ø=180mm

4109065 SPARTIFI
AMMA DIA 60 MM /
FLAME SPREADER
60MM
OC0129:
ELECTROLUX
PROFESSIONAL
S.P.A.



Ø=60 mm

4103099 BRUCIAT
ORE GW20 OVALE
RICAMBI ø 40x445
mm /
BURNER ø 40x445
mm
15100007ex:
ELFRAMO SPA
15100009:
ELFRAMO SPA



NOZZLE=4105153

S&P Cooking Catalogue 2017

4109115 SPARTIFI
AMMA 3 KW
EMMEPI D.70MM /
FLAME SPREADER 3
KW EMMEPI D.70MM
C10284:
EMMEPI GRANDI
CUCINE S.R.L.



4109110 SPARTIFI
AMMA ø 100 mm 5Kw
/
FLAME SPREADER ø
100 mm 5Kw
C10285:
EMMEPI GRANDI
CUCINE S.R.L.



4109070 SPARTIFI
AMMA EMMEPI
7,5KW /
FLAME SPREADER ø
120 mm 7.5KW
4109070:
EMMEPI GRANDI
CUCINE S.R.L.



4111183 SUPPORT
O BRUCIATORE KW
7,5 -700P/900 /
HOLDER BURNER 7.5
KW -700P/900
C00816:
EMMEPI GRANDI
CUCINE S.R.L.



4109015 COPERCHI
O BRUCIATORE
FABA CREPIERES
GAS /
BURNER COVER FOR
GAS CREPIERES
FABA
PR3G029: FABA SRL

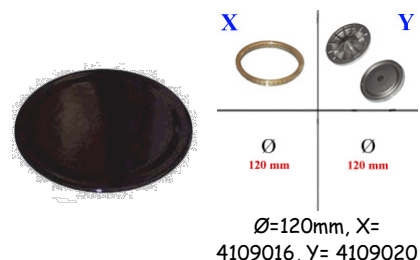

4109016 SPARTIFI
AMMA BRUCIATORE
CREPIERES FABA /
BURNER FLAME
SPREADER FOR
CREPIERES FABA
PR3G030: FABA SRL

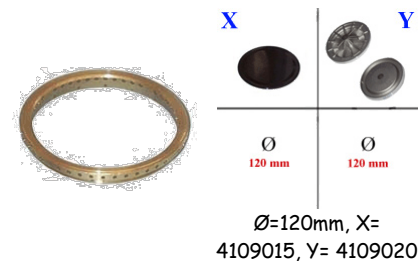

4109020 SUPPORT
O SPARTIFIAMMA /
FLAME SPREADER
HOLDER
PR3G031: FABA SRL

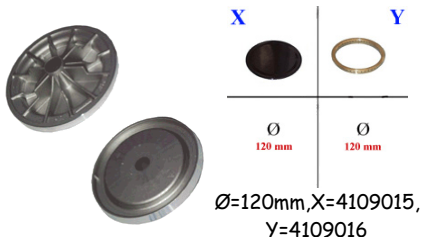

4109074 ASSIEME
SPARTIFIAMMA
GICO D.60 /
FLAME SPREADER
GICO D.60
A00003: GICO SPA



4109108 SPARTIFI
AMMA BRUCIATORE
GRANDE RAPIDO /
RAPID CAP BURNER
270204240:
GICO SPA



4109109 ASSIEME
COPERCHIO CON
SPARTIFIAMMA
GRANDE RAPIDO /
ASSEMBLY COVER
WITH GREAT QUICK
burner
A00004: GICO SPA

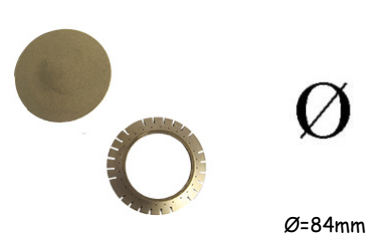

4109075 COPERCHI
O GRANDE
SPARTIFIAMMA D
.84mm /
BRENNERDECKEL D
.84mm
290200480:
GICO SPA

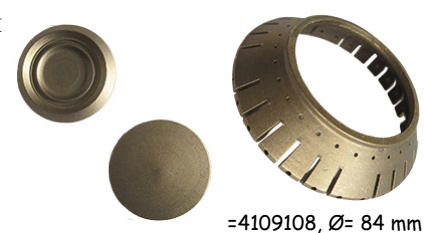

4109077 SPARTIFI
AMMA DOPPIA
CORONA D.110 MM /
BURNER CAP
D.110MM
270203540:
GICO SPA

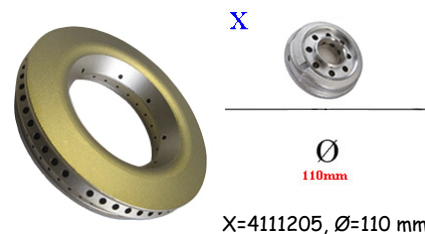

4111214 SPARTIFI
AMMA BRUCIATORE
GRANDE DOPPIA
CORONA C/F.DM.3,5 /
BURNER
D.COR.C/F.DM.3,5
290204930:
GICO SPA



4111142 BASE
BRUCIATORE GICO
D.60 /
BURNER HEAD GICO
D.60
790300789:
GICO SPA



S&P Cooking Catalogue 2017

4111143 CORPO
BRUCIATORE /
BURNER HEAD
770336750:
GICO SPA



4111206 ASSIEME
BRUCIATORE S-900 /
BURNER S-900
A00504: GICO SPA



Ø=102mm

4111205 ASSIEME
BRUCIATORE D.C.
GR. TIPO-A S-500-110
/
BURNER ASSEMBLY
TYPE-A S-500-110
A00419: GICO SPA



X



110mm

X=4109077, Ø=110mm

4109030 SPARTIFI
AMMA DOPPIA
CORONA 3,5KW /
DOUBLE CROWN
FLAME SPREADER
3,5KW
X21600: GIGA
0100252:
SILKO ALI SPA
SIR0100252:
SILKO ALI SPA



X



75 mm

X=4111058, Ø=75mm

4109031 SPARTIFI
AMMA DOPPIA
CORONA 5,5KW /
DOUBLE CROWN
FLAME SPREADER
5,5KW
X21700:
GIGA GRANDI
CUCINE SRL



X



95 mm

X=4111059, Ø=95mm

4109037 SPARTIFI
AMMA DOPPIA
CORONA 7KW K900 /
DOUBLE CROWN
FLAME SPREADER
7KW K900
X21800:
GIGA GRANDI
CUCINE SRL



X



121 mm

X=4111098, Ø=121 mm

4111058 CORPO
BRUCIATORE 3,5KW
/
BURNER 3,5KW
0900X21000:
GIGA GRANDI
CUCINE SRL



X



75 mm

X= 4109030, Ø=75mm

4111059 CORPO
BRUCIATORE 5,5KW
/
BURNER 5,5KW
0750X21100: GIGA
0900X21100:
GIGA GRANDI
CUCINE SRL



X



95 mm

X= 4109031, Ø=95mm

4111098 CORPO
BRUCIATORE
NICHELATO GIGA
D.120 CON PILOTA /
BURNER GIGA D. 120
WITH PILOT
721-026-00: GIGA
0750X21200: GIGA



X



120 mm

X= 4109037, Ø=120 mm

4109106 SPARTIFI
AMMA .CORONA 073
4 Z CR.S70 Ø 73mm /
BURNER CAP 073 4 Z
CR.S70 Ø 73mm
532007400:
LOTUS SPA

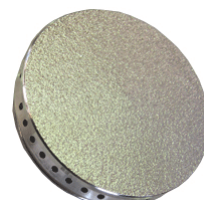

Ø= 73mm

4109098 SPARTIFI
AMMA 80 mm 7 kW
/
BURNER CAP 80mm
7kW
532003800:
LOTUS SPA



Ø=80 mm

4109076 SPARTIFI
AMMA LOTUS D.100 /
FLAME SPREADER
LOTUS D.100
532003900:
LOTUS SPA



Ø=100 mm

4111156 CORPO
BRUCIATORE /
BURNER HEAD
532004200:
LOTUS SPA



Ø=73mm

4109104 SPARTIFI
AMMA silko 65 mm /
Burner cap silko 65 mm
CR0580010:
SILKO ALI SPA
CR0580010:
MARENO
INDUSTRIE ALI
SPA



Ø=65mm

S&P Cooking Catalogue 2017

4109023 SPARTIFI
AMMA BRUC. /80 /
BURNER FLAME
SPREADER /80
MA1315612:
MARENO
MA1315612:
SILKO ALI SPA



X=4111030, Ø=80mm

4109025 SPARTIFI
AMMA D. 80mm /
FLAME SPREADER D.
80mm
MACM027600:
MARENO
CM027600:
SILKO ALI SPA

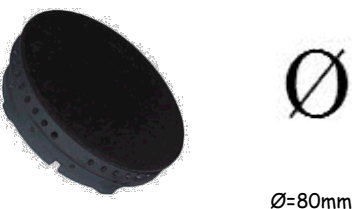

Ø=80mm

4109116 SPARTIFI
AMMA MARENO
D.100 /
FLAME SPREADER
MARENO D.100

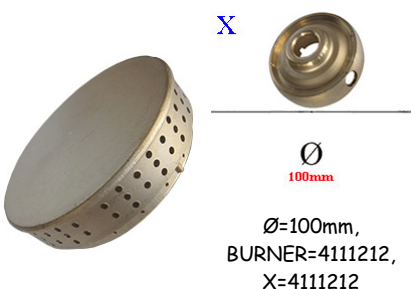

Ø=100mm,
BURNER=4111212,
X=4111212

4109026 SPARTIFI
AMMA D. 110mm /
FLAME SPREADER
D. 110mm
MACM027100:
MARENO
INDUSTRIE ALI
SPA

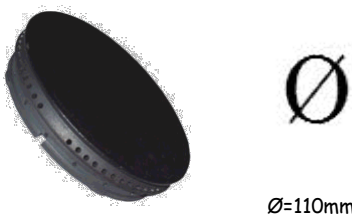

Ø=110mm

4109022 SPARTIFI
AMMA BRUC. /110 /
BURNER FLAME
SPREADER /110
MA1315712:
MARENO
1315712:
SILKO ALI SPA



X=4111029, Ø=110mm

4111030 CORPO
BRUCIATORE /80 /
BURNER /80
MA1315422:
MARENO
INDUSTRIE ALI
SPA
MA1315422:
SILKO ALI SPA

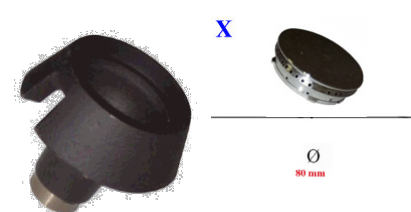

X=4109023, Ø=80mm

4111212 CORPO
BRUCIATORE
MARENO D.100 /
BURNER MARENO
D.100



Ø=100mm, X=4109116

4111029 CORPO
BRUCIATORE /110 /
BURNER /110
MA1315522:
MARENO
INDUSTRIE ALI
SPA
1315522:
SILKO ALI SPA



Ø=110mm, X=4109022

4109058 CORONA
3010KCAL /
FLAME SPREADER
3010KCAL
1032009600:
MARENO
BN6A042000: OLIS
0100247: SILKO
ALI
22285300: BERTO'S
MA1032009600:
MARENO
SIR0100247: SILKO



Ø=90mm

4109021 SPARTIFI
AMMA BRUC. /120 /
FLAME SPREADER
D.120
MA1316012:
MARENO
INDUSTRIE ALI
SPA
MA1316012:
SILKO ALI SPA



X=4111028, Ø=120mm

4109024 SPARTIFI
AMMA Ø=120mm /
FLAME SPREADER
D.120mm
MACM027200:
MARENO
INDUSTRIE ALI
SPA
MACM027200:
SILKO ALI SPA

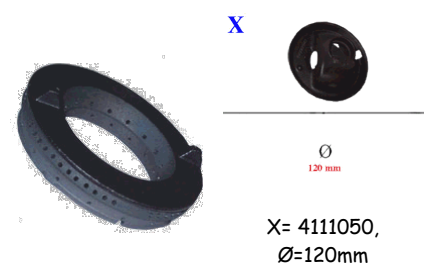

X= 4111050,
Ø=120mm

4111050 CORPO
BRUCIATORE
Ø=120mm /
BURNER ?=120mm
MACM006502:
MARENO
INDUSTRIE ALI
SPA
MACM006502:
SILKO ALI SPA



X= 4109024,
Ø=120mm

4111028 CORPO
BRUCIATORE/120 /
BURNER /120
MA1315922:
SILKO ALI SPA
MA1315922:
MARENO
INDUSTRIE ALI
SPA

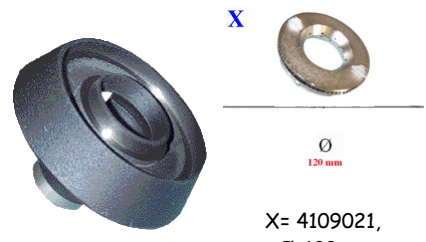

X= 4109021,
Ø=120mm

S&P Cooking Catalogue 2017

4111053 VENTURI
PER BRUCIATORE
/80 /
AIR REGULATOR /80
MA1315212:
MARENO
INDUSTRIE ALI
SPA



Ø=80mm

4111054 VENTURI
PER BRUCIATORE
110 /
AIR REGULATOR
/110
MA1315300:
MARENO
INDUSTRIE ALI
SPA



Ø=110mm

4109073 SPARTIFI
AMMA 1KW
CENT.G4S9 /
FLAME SPREADER
1KW CENT.G4S9
160295:
MBM- EUROTEC SRL
- DIV. COOKING
SERVICE

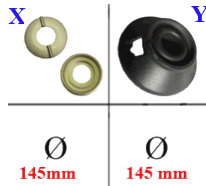

Ø=45 mm, X=
4109072, Y= 4111138

4109063 SPARTIFI
AMMA 3,5KW G4SF7
/
FLAME SPREADER
3,5KW G4SF7
RTC700375: MBM-
EUROTEC SRL -
DIV. COOKING
SERVICE
3025401: L



Ø=75 mm X= 4111131

4109100 COPERCHI
O BRUCIATORE
MEDIO DOPPIA
CORONA /
BURNER COVER
MEDIUM DOUBLE
WREATH
270203550:
MBM- EUROTEC SRL
- DIV. COOKING
SERVICE
270203550:
GICO SPA



Ø=90 mm

4109038 SPARTIFI
AMMA 6KW G4SF7 /
FLAME SPREADER
6KW G4SF7
RTC700376:
MBM- EUROTEC SRL
- DIV. COOKING
SERVICE



X=4111099, Ø=115 mm

4109072 SPARTIFI
AMMA 7KW G4S9 /
FLAME SPREADER
7KW G4S9
160294:
MBM- EUROTEC SRL
- DIV. COOKING
SERVICE

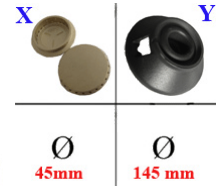

Ø=145mm, X=
4109073, Y= 4111138

4111003 BRUCIAT
ORE MBM 3000 /
BURNER MBM 3000
GRCU700058ex:
MBM- EUROTEC SRL
- DIV. COOKING
SERVICE

GRCU700021ex:
MBM- EUROTEC SRL
- DIV. COOKING
SERVICE

RTC700009ex:
MBM- EUROTEC SRL
- DIV. COOKING
SERVICE
RTC700124ex:
MBM- EUROTEC SRL
- DIV. COOKING
SERVICE

GRCU700018:
MBM- EUROTEC SRL
- DIV. COOKING
SERVICE

4111131 BRUC.3,5K
W G4SF7 SMALT. /
BURNER 3.5KW
G4SF7
RTC700380:
MBM- EUROTEC SRL
- DIV. COOKING
SERVICE

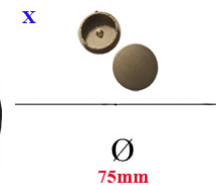
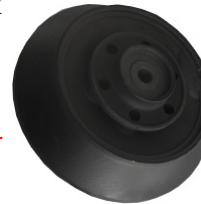

Ø=75 mm, X= 4109063

4111004 BRUCIAT
ORE MBM 5000 /
BURNER MBM 5000
GRCU700022:
MBM- EUROTEC SRL
- DIV. COOKING
SERVICE

806099:
EMMEPI GRANDI
CUCINE S.R.L.
RTC700010EX:
MBM- EUROTEC
SRL - DIV.
COOKING SERVICE

4111099 BRUC.6K
W G4SF7 SMALT. /
BURNER 6KW G4SF7
RTC700382:
MBM- EUROTEC SRL
- DIV. COOKING
SERVICE

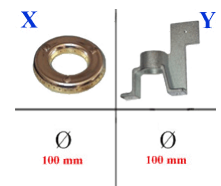

Ø=100mm, X=
4109003, Y= 4117404

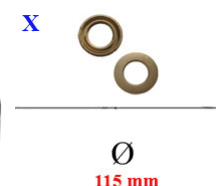

Ø=115 mm

X= 4109038, Ø=115 mm

4111005 BRUCIAT
ORE MBM 7000 /
BURNER MBM 7000
6RCU700023:
MBM- EUROTEC SRL
- DIV. COOKING
SERVICE



4109039 SPARTIFI
AMMA MODULAR
D.110 7,5KW /
FLAME SPREADER
MODULAR D.110
7,5KW
67209300:
MODULAR SPA

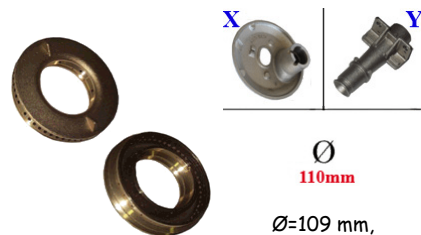

4111138 BRUC.8K
W G4S9 SMALT. /
BURNER 8KW G4S9
160296:
MBM- EUROTEC SRL
- DIV. COOKING
SERVICE

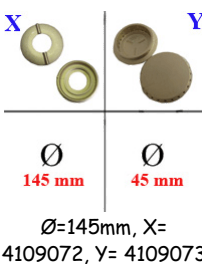

4109054 SPARTIFI
AMMA MODULAR
MOD. "D" D.109
5,5KW /
FLAME SPREADER
MODULAR MOD. "D"
D.109 5,5KW
67207900:
MODULAR SPA



4111077 SUPPORT
O BRUCIATORE 7000
ZN MBM /
BURNER HOLDER
7000 ZN MBM
RTC700008:
MBM- EUROTEC SRL
- DIV. COOKING
SERVICE



4111140 TESTA
BRUCIATORE
MODULAR D.110
5,5KW /
BURNER HEAD
MODULAR D.110
5,5KW
67207700:
MODULAR SPA

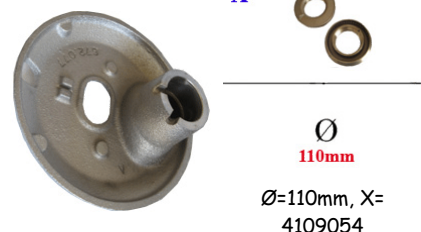

4117403 SUPPORT
O BRUC.3000 ZINC. /
BURNER HOLDER
3000
RTC700006:
MBM- EUROTEC SRL
- DIV. COOKING
SERVICE

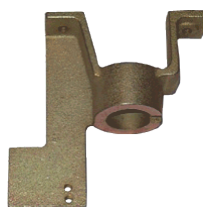

4111141 TESTA
BRUCIATORE
MODULAR D.110
7,5KW /
BURNER HEAD
MODULAR D.110
7,5KW
67210100:
MODULAR SPA

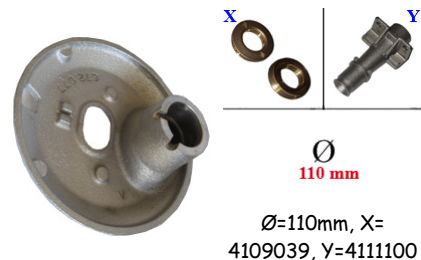

4117404 SUPPORT
O BRUC.5000 ZINC. /
BURNER-HOLDER
5000
RTC700007:
MBM- EUROTEC SRL
- DIV. COOKING
SERVICE



4111100 VENTURI
PER BRUCIATORE
TOP MODULAR /
AIR REGULATOR
TOP MODULAR
67201000:
MODULAR SPA

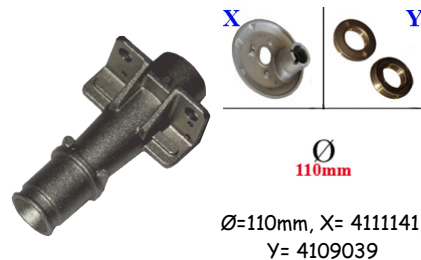

4109114 SPARTIFI
AMMA BRUCIATORE
16 FERITIOIE /
BURNER FLAME
SPREADER
67209800:
MODULAR SPA



4111160 BASE
BRUCIATORE /
BURNER LOWER
PART
67212900:
MODULAR SPA



S&P Cooking Catalogue 2017

4109041 SPARTIFI
AMMA OT. DOPPIA
CORONA C.90 KW 3,5
/
DOUBLE CROWN
FLAME SPREADER
C.90 KW 3,5
828125:
**OFFCAR THE GREAT
COOKING S.R.L.**



4109062 SPARTIFI
AMMA OLIS Ø80MM /
FLAME SPREADER
OLIS D.80MM
BN2510352:
**OLIS DIVISIONE
DI ALI GROUP SPA**
-

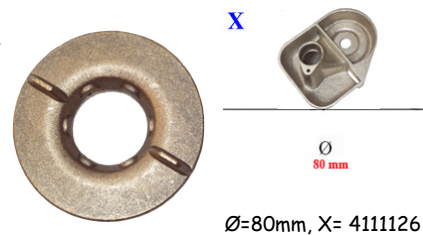

4109040 SPARTIFI
AMMA DOPPIA
CORONA 115 KW 5,5 /
DOUBLE CROWN
FLAME SPREADER
115 KW 5,5
828131:
**OFFCAR THE GREAT
COOKING S.R.L.**



4109059 SPARTIFI
AMMA OLIS Ø105MM
/
FLAME SPREADER
OLIS D.105MM
BN2510355:
**OLIS DIVISIONE
DI ALI GROUP SPA**
-



4111103 BRUCIAT
ORE DOPPIA
CORONA 90 KW3,5 /
BURNER 90 KW 3,5
827345:
**OFFCAR THE GREAT
COOKING S.R.L.**



4109060 SPARTIFI
AMMA OLIS Ø125MM
/
FLAME SPREADER
OLIS D.125MM
BN2510358ex:
**OLIS DIVISIONE
DI ALI GROUP SPA**
-
BN2510341:
**OLIS DIVISIONE
DI ALI GROUP SPA**
-

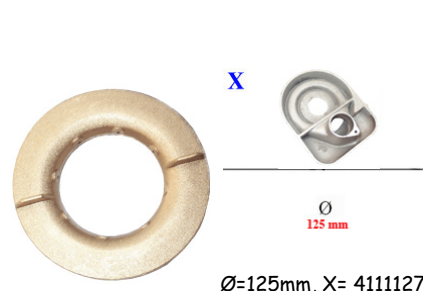

4111102 BRUCIAT
ORE DOPPIA
CORONA 115 KW 5,5 /
BURNER 115 KW 5,5
827351:
**OFFCAR THE GREAT
COOKING S.R.L.**



4111117 BRUCIAT
ORE OLIS 75 MM /
BURNER OLIS 75 MM
BN2510600:
**OLIS DIVISIONE
DI ALI GROUP SPA**
-

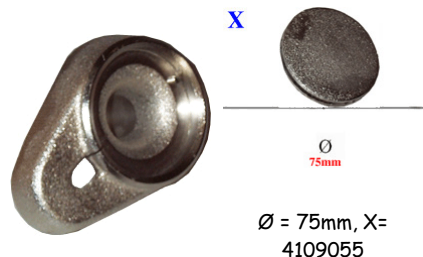

4109055 SPARTIFI
AMMA OLIS D. 75 /
FLAME SPREADER
OLIS D.75
BN2510601:
**OLIS DIVISIONE
DI ALI GROUP SPA**
-



4111128 TESTA
BRUCIATORE Ø
85MM OLIS /
BURNER HEAD Ø
85MM OLIS
BN2510189:
**OLIS DIVISIONE
DI ALI GROUP SPA**
-

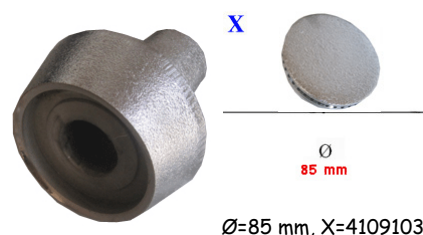

4109103 SPARTIFI
AMMA PICCOLO D.85
S90 /
BURNER COVER
SMALL S90
BN2510190:
**OLIS DIVISIONE
DI ALI GROUP SPA**
-

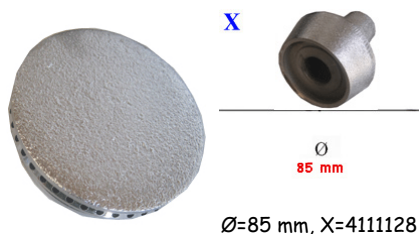

4111122 BRUCIAT
ORE OLIS Ø125MM /
BURNER OLIS 125
MM
BN2510194:
**OLIS DIVISIONE
DI ALI GROUP SPA**
-

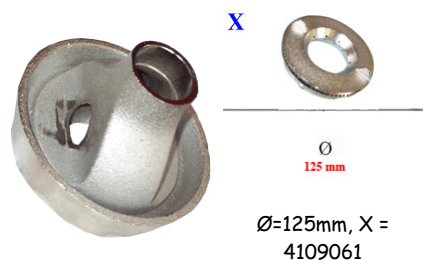

S&P Cooking Catalogue 2017

4111126 TESTA
BRUCIATORE OLIS Ø
80 MM /
BURNER OLIS ? 80
MM

BN2510351:
OLIS DIVISIONE
DI ALI GROUP SPA

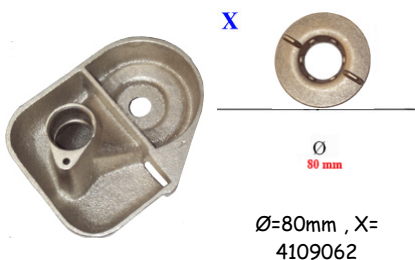

Ø=80mm , X=
4109062

4111066 BRUCIAT
ORE KW3,5 RAF
LUCIDO X ACC.EL. /
BURNER ? 75mm

0100298:
SILKO ALI SPA
SIRO100298:
SILKO ALI SPA



4111123 BRUCIAT
ORE OLIS Ø105 MM /
BURNER OLIS 105
MM

BN2510354:
OLIS DIVISIONE
DI ALI GROUP SPA

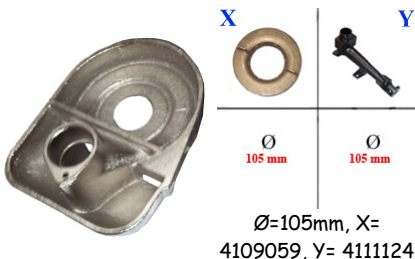

Ø=105mm, X=
4109059, Y= 4111124

4111109 CORPO
BRUCIATORE CON
BOCCOLA 5,5 KW /
BURNER ? 95mm

22280400:
BERTO'S SPA
0100209EX:
SILKO ALI SPA
0100299:
SILKO ALI SPA



Ø = 95mm,
X=4109045

4111127 TESTA
BRUCIATORE Ø125
MM /
BURNER OLIS ?125
MM

BN2510357:
OLIS DIVISIONE
DI ALI GROUP SPA

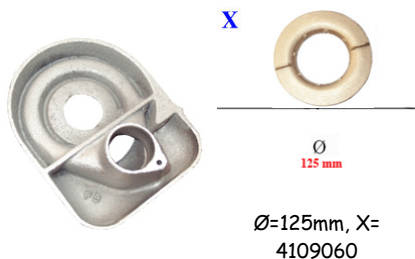

Ø=125mm, X=
4109060

4111110 CORPO
BRUCIATORE CON
BOCCOLA 7 KW /
BURNER HEAD 7 KW

0100300:
SILKO ALI SPA
SIRO100300:
SILKO ALI SPA



Ø=120mm

4111124 VENTURI
BRUCIATORE OLIS
Ø105 MM /
BURNER NOZZLE
OLIS ?105 MM

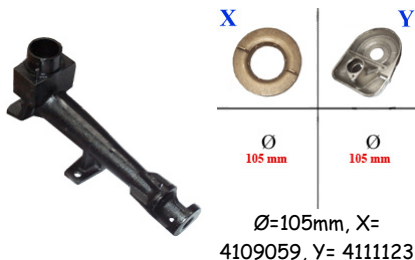

Ø=105mm, X=
4109059, Y= 4111123

4111112 VENTURI
PER BOCCOLA 5,5
KW /
BURNER NOZZLE 5,5
KW

0100302:
SILKO ALI SPA
SIRO100302:
SILKO ALI SPA



4109049 SPARTIFI
AMMA 3500 KCAL /
FLAME SPREADER
3500KCAL

0100244:
SILKO ALI SPA

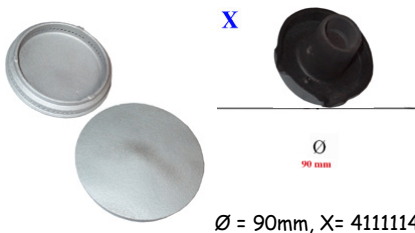

Ø = 90mm, X= 4111114

4111067 VENTURI
BRUC. 3,5KW LAV.X
BOCCOLA /
BURNER NOZZLE

SIRO100301:
SILKO ALI SPA
0100301:
SILKO ALI SPA



4111114 BRUCIAT
ORE 3500KCAL /
BURNER 3500KCAL

0100232:
SILKO ALI SPA
SIRO100232:
SILKO ALI SPA

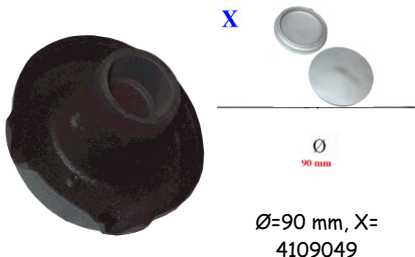

Ø=90 mm, X=
4109049

4111111 VENTURI
PER BOCCOLA 7 KW
/
BURNER NOZZLE
?110mm

0100303:
SILKO ALI SPA
SIRO100303:
SILKO ALI SPA



4111006 BRUCIAT
ORE 1828112 GB94G /
BAR BURNER 2 ROW
L 435mm W 205mm H
50mm CHARGRILL
STAINLESS STEEL

MA1828112:
MARENO
1828112:
SILKO ALI SPA



S&P Cooking Catalogue 2017

4111008 BRUCIAT
ORE ZANUSSI 056655
/
BURNER ZANUSSI
056655
056655:
ELECTROLUX
PROFESSIONAL



4111017 BRUCIAT
ORE ZANUSSI 055007
/
BURNER ZANUSSI
055007
055007:
ELECTROLUX
PROFESSIONAL
S.P.A.



4111020 BRUCIAT
ORE L=700mm /
BURNER L=700mm
GIRARROSTI GAS
12/20P: CB SRL
08110583EX: CB SRL



4111024 BRUCIAT
ORE PENTOLE
7000KCAL 776/10 /
POTS BURNER
7000KCAL 776/10
MA1413000:
MARENO
INDUSTRIE ALI
SPA

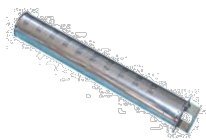

4111032 BRUCIAT
ORE FORNO A.PO' /
OVEN BURNER A.PO
34A1370:
ANGELO PO
GRANDI CUCINE
SPA



4111037 BRUCIAT
ORE FORNO A.PO' /
OVEN BURNER A.PO
34A1520:
ANGELO PO
GRANDI CUCINE
SPA



4111038 BRUCIAT
ORE FORNO A.PO' /
OVEN BURNER A.PO
34A1880:
ANGELO PO
GRANDI CUCINE
SPA



4111044 BRUCIAT
ORE A.PO' /
BURNER A.PO
34A1450:
ANGELO PO
GRANDI CUCINE
SPA



4111033 BRUCIAT
ORE COMPLETO /
BURNER
34A1640:
ANGELO PO
GRANDI CUCINE
SPA



4111045 BRUCIAT
ORE 5 KW §2.0mm
A.PO' /
BURNER 5 KW
?2.0mm A.PO'
34A1510:
ANGELO PO
GRANDI CUCINE
SPA



4111061 BRUCIAT
ORE 335XD.28mm
APO /
BURNER
335XD.28mm A.PO
34A0230:
ANGELO PO
GRANDI CUCINE
SPA



4111047 BRUCIAT
ORE 12 KW A.PO' /
BURNER 12 KW A.PO
34A0810:
ANGELO PO
GRANDI CUCINE
SPA



4111194 BRUCIAT
ORE 6-7KW
D.40X425mm /
BURNER 6-7KW
D.40X425mm
34A1680:
ANGELO PO
GRANDI CUCINE
SPA



DIMENSIONS
D.40X425mm

4111062 BRUCIAT
ORE PIASTRA A PO /
PLATE BURNER A.PO
34A1461:
ANGELO PO
GRANDI CUCINE
SPA



S&P Cooking Catalogue 2017

4111043 BRUCIAT
ORE CUOCIPASTA A.
PO' /
PASTA COOKER
BURNER A.PO
34A0350:
ANGELO PO



4111036 BRUCIAT
ORE 12 KW A.PO' /
BURNER 12KW A.PO
34A0900:
ANGELO PO
GRANDI CUCINE
SPA



4111039 BRUCIAT
ORE A.PO' /
BURNER A.PO
34A1551:
ANGELO PO
GRANDI CUCINE
SPA

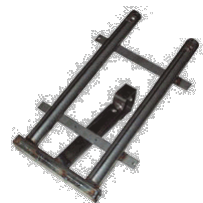

4111040 BRUCIAT
ORE MULTIGAS
A.PO' /
MULTIGAS BURNER
A.PO
34A0110:
ANGELO PO

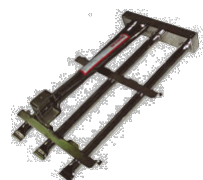

4111133 BRUCIAT
ORE D.40 FORNO S90
/
BURNER D.40 OVEN
S90
K26100: A.T.A. SRL



4111075 BRUCIAT
ORE L=1000mm /
BURNER L=1000mm
GIRARROSTI GAS
24/48P: CB SRL
08118614EX: CB SRL



4111073 BRUCIAT
ORE 2 RAMPE /
BURNER 2 RAMPS
08110013EX: CB SRL
08CC0056: CB SRL



4111071 BRUCIAT
ORE 3 RAMPE /
BURNER 3 RAMPS
08110009ex: CB SRL
08CC0044: CB SRL



4111072 BRUCIAT
ORE 4 RAMPE /
BURNER 4 RAMPS
08110010EX: CB SRL
08CC0046: CB SRL



4111068 BRUCIAT
ORE COMPLETO 4
RAMPE /
COMPLETE BURNER
4 RAMPS
08111361: CB SRL

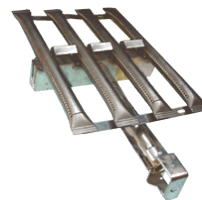

4111069 BRUCIAT
ORE COMPLETO 5
RAMPE /
COMPLETE BURNER
5 RAMPS
08110003: CB SRL
08111343: CB SRL



4111070 BRUCIAT
ORE COMPLETO 6
RAMPE /
COMPLETE BURNER
6 RAMPS
08111328: CB SRL



4111176 BRUCIAT
ORE /
BURNER
006127:
ELECTROLUX
PROFESSIONAL
S.P.A.



4111101 BRUCIAT
ORE /
BURNER
059523:
ELECTROLUX
PROFESSIONAL
S.P.A.



4111154 BRUCIAT
ORE GRIGLIA
600x220 mm /
BURNER 600x220 mm
002358:
ELECTROLUX
PROFESSIONAL
S.P.A.



DIMENSIONS
600X220mm

S&P Cooking Catalogue 2017

4111161 BRUCIAT
ORE /
BAR BURNER 3 ROW
L 640mm H 265mm
CHARGRILL
0C0490:
ELECTROLUX
PROFESSIONAL
S.P.A.



4111203 BRUCIAT
ORE /
BURNER
003634:
ELECTROLUX
PROFESSIONAL
S.P.A.



4111197 X15571000
0 QUEMADOR
COMPLETO SBG9-10 /
BURNER X155710000
X155710000:
FAGOR
INDUSTRIALE
S.R.L.
12007248:
FAGOR
INDUSTRIALE
S.R.L.



4111165 BRUCIAT
ORE MULTIGAS PER
10TG /
MULTIGAS BURNER
FOR 10TG
0767A:
FOINOX S.P.A.



4111207 BRUCIAT
ORE MULTIGAS
11KW /
BURNER 11KW
4323120: GICO SPA



Ø=50mm, L=405mm

4111181 ASS.
BRUCIATORE
MULTIGAS 510 /
BURNER ASSY 510
MULTIGAS
790117780: GICO
SPA
A00458ex: GICO
SPA



Ø=40mm, L=510mm

4111149 BRUCIAT
ORE GAS PIETRA
LAVICA SERIE 700
445x200 MM /
BAR BURNER 2 ROW
L 445mm W 200mm H
50mm CHARGRILL
A00273: GICO SPA



4111152 BRUCIAT
ORE DX FRG L900 /
BURNER RIGHT FRG
L900
R920153: ILSA SPA



4111204 ASSIEMEB
RUCIATORE C/TAPPI
BR.1+1/2 E SPART. /
BURNER WITH CAPS
ASSEMBLY
A00647: GICO SPA
90123500: GICO
SPA



DIMENSIONS
860X560mm

4111153 BRUCIAT
ORE SX FRG L900 /
BURNER LEFT FRG
L900
R920151: ILSA SPA



4111198 BRUCIAT
ORE PENTOLE 900
103220600 /
BURNER POTS 900
103220600
MACM088100:
MARENO
INDUSTRIE ALI
SPA
MACM088100:
SILKO ALI SPA



L=475mm

4111137 AS.BRUC.
FGC100 /
BAR BURNER FOR
HOT AIR OVEN
FGC100
GAFOC00073:
MBM- EUROTEC SRL



4111132 BRUCIAT
ORE PIETRA LAVICA
ASS.TO /
LAVA STONE
BURNER
ASSEMBLED
2010924ex:
MBM- EUROTEC SRL
*: GIORIK SPA
RIC0002519:
MBM- EUROTEC SRL



4111182 BRUC.GPL
47 18196153000 /
BURNER GPL47
RTC0700483:
MBM- EUROTEC SRL
- DIV. COOKING
SERVICE



4111170 BRUCIAT
R/BRG 18196213001 /
BURNER GBR/BRG
18196213001
RTBF900098:
MBM- EUROTEC SRL



4111185 BRUCIAT
ORE COMPLETO
INFERIORE /
BURNER LOWER
LAR11224161:
LAINOX ALI SPA



4111213 BRUCIAT
ORE A BARRA
OFFCAR L.505MM /
BURNER OFFCAR
L.505MM
841211:
OFFCAR THE
GREAT COOKING
S.R.L.



Ø=50mm, L=505mm

4117431 AS.TU.AL.
ANT.BRUC.6KW
G4SF7 /
BURNER 6KW G4SF7
GACU700136:
MBM- EUROTEC
SRL - DIV.
COOKING SERVICE
173321:
MBM- EUROTEC SRL
- DIV. COOKING
SERVICE



4111208 BRUCIAT
ORE /
BURNER
4111208:
OLIS DIVISIONE
DI ALI GROUP SPA



Ø=50mm, L=280mm

4111166 AS.TU.AL.
ANT.BRUC.6KW
G4S1 /
BURNER 6KW G4S1
164556:
MBM- EUROTEC SRL
- DIV. COOKING
SERVICE



4111180 BRUCIAT
ORE 788/11/A KBG 80
74/02 /
BURNER 788/11/A
KBG 80 74/02
BN2510651:
OLIS DIVISIONE
DI ALI GROUP SPA
-



Ø=50mm, L=345

4111167 *AS.TU.AL
.POST.BRUC.6KW
G4S9 VEDI NOTE /
BURNER 6KW G4S9
160144:
MBM- EUROTEC SRL
- DIV. COOKING
SERVICE



4111147 BRUCIAT
ORE OLIS L 450 MM P
280 MM H 65 MM /
BURNER OLIS L 450
mm P 280 MM H 65
MM
BN251950:
OLIS DIVISIONE
DI ALI GROUP SPA
-



4111168 *AS.TU.AL
.ANT.BRUC.3,5KW
G4S9 /
BURNER 3,5KW G4S9
160141:
MBM- EUROTEC SRL
- DIV. COOKING
SERVICE



4111118 GRUPPO
BRUC.GAS 2GR /
GAS BURNER 2GR
30300075:
RANCILIO SPA



4111196 ASSIEME
TUBO
ALIMENTAZIONE
POSTERIORE
BRUCIATORE 6KW
G4SF7+BOCC. /
REAR VENTURI 6KW
GACU700138:
MBM- EUROTEC SRL
- DIV. COOKING
SERVICE
173322:
MBM- EUROTEC SRL
- DIV. COOKING
SERVICE



4111162 BRUCIAT
ORE GRIGLIA
PIETRA LAVICA /
BAR BURNER 4 ROW
L 480mm W 450mm
CHARGRILL
PLX20003:
UNIVERSO SRL



S&P Cooking Catalogue 2017

4111035 BRUCATO
RE §225 COMPLETO
A.PO' /
BURNER ?225 A.PO
34A0120:
ANGELO PO
GRANDI CUCINE
SPA



4111184 BRUCIAT
ORE AMBACH D.120
mm H 102 mm L 340
mm /
BURNER AMBACH
D.120 mm H 102 mm L
340 mm
3516911678:
AMBACH



DIMENSIONS
D.120 mm H 102 mm
L 340 mm

4111042 BRUCIAT
ORE
VER.FRIGGITRICE
A.PO' /
VERTICAL BURNER
FOR FRYER A.PO
34A1670:
ANGELO PO
GRANDI CUCINE
SPA



4111034 BRUCIAT
ORE § 160 A.PO' /
BURNER ? 160 A.PO
34A1650:
ANGELO PO
GRANDI CUCINE
SPA



4111046 BRUCITO
RE VER,
FRIGGITRICE A.PO' /
VERTICAL BURNER
FOR FRYER A.PO
34A1530:
ANGELO PO
GRANDI CUCINE
SPA



4111074 TUBETTO
PASSAGGIO FIAMMA
CB /
BURNER PIPE CB
GRIGLIE GC-I: CB
SRL



4111151 BRUCIAT
ORE 8KW. /
BURNER 8KW
3007720:
ANGELO PO
GRANDI CUCINE
SPA



4111076 BRUCIAT
ORE GYROS /
GYROS BURNER
GYROS: CB SRL

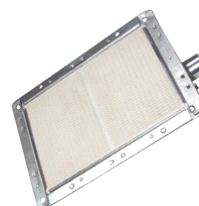

4111199 GRUPPO
SUPPORTO
BRUCIATORE 10KW /
GROUP SUPPORT
BURNER 10KW
6014831:
ANGELO PO
GRANDI CUCINE
SPA



4111186 VENTURI
BRUCIATORE S70 /
VENTURI BURNER
S70
533101000:
LOTUS SPA



4111169 BRUCIAT
ORE COMPLETO /
BURNER
R11202480:
LAINOX ALI SPA
LAR11202480:
LAINOX ALI SPA



4111195 SCAMBIA
TORE COMPLETO DI
ACCESSORI /
EXCHANGE
COMPLETE OF
ACCESSORIES
LAR14211470:
LAINOX ALI SPA



4111210 LANCIA
BRUCIATORE
TP.NUOVO /
oem burner new type
GA30700:
OEM ALI SPA



1132007 COPERCHI
O MINISIT /
COVER MINISIT
0903052: SIT
56577:
ELECTROLUX
PROFESSIONAL
S.P.A.



1132001 COPERCHI
O CON PIEZO SIT /
COVER WITH PIEZO
ELECTRIC LIGHTER
SIT

611002:

ELETTROBAR

0073203: SIT

0073006ex: SIT

0073208: SIT

1262300-1393700:

MARENO

INDUSTRIE

BN6A011603: OLIS

100857: SILKO ALI

67102800:

MODULAR

00032410+0003246:

ELFRAMO SPA

7020230: GIORIK

0100857:

LAINOX ALI SPA

SIRO100857:

SILKO ALI SPA



1132005 PIEZO
ELETTRICO D. 18mm /
PIEZO ELECTRIC
LIGHTER D. 18

M02100: GIGA

3005580: ANGELO

PO

MA1936100:

MARENO

INDUSTRIE

537002800: LOTUS

MA986000:

MARENO

INDUSTRIE

5060408640: AMBAC

H

BN6A041105: OLIS

3991130359: FAEMA

22188300: BERTO'S

1936100: SILKO ALI

M00500: GIGA

32188200: BERTO'S

PR3G047: FABA SRL

MA1936100: OLIS

MA1936100: SILKO



1132002 PIEZO
ELETTRICO D. 22MM
AT.TONDO /
PIEZO ELECTRIC
LIGHTER D. 22MM

0073952: SIT

RTC0700020:

MBM- EUROTEC SRL

-

1031500600:

MARENO

INDUSTRIE

537008500: LOTUS

690000020:

RANCILIO SPA

210011: MAGISTER



004944*:

ELECTROLUX

33100003:ELFRAMO

15010:

CMA MACCHINE

PER CAFFE' SRL

0073960: SIT

6010047: GIORIK

SPA

1132014 ACCENSI

ONE PIEZO HV

GENERATOR /

PIEZO ELECTRIC

LIGHTER HV

GENERATOR

GRIGLIE TUTTI I

MODELLI: CB SRL



1132004 ACCENSI

TORE PIEZO

ZANUSSI 002605 /

PIEZO ELECTRIC

LIGHTER 002605

0C9240:

ELECTROLUX

002605EX:

ELECTROLUX



1132023 CAPPUCCI

O PER PIEZO

ELETTRICO /

CAP FOR PIEZO

ELECTRIC

32188400:

BERTO'S SPA



1132018 COPRIPUL

SANTE PIEZO /

SLOT COVER FOR

PIEZOELECTRIC

STARTERS

0C9409:

ELECTROLUX

002816:

ELECTROLUX



1132022 ACCENSI

TORE PIEZO

ROTATIVO D.18 /

PIEZO ROTARY D.18

32T0130:

ANGELO PO

GRANDI CUCINE

SPA



1132024 PIEZO

PORTABATTERIA

CON PULSANTE /

PIEZO BATTERY

TRAYS WITH

BUTTON



1132006 ACCENDI
TORE PIEZO 058225 /
PIEZO ELECTRIC
LIGHTER 058225

052539:
ELECTROLUX
PROFESSIONAL
S.P.A.
058225:
ELECTROLUX



1132010 GRUPPO
ACCENSIONE A.PO /
PIEZO ELECTRIC
LIGHTER A.PO

32T0030:
ANGELO PO
GRANDI CUCINE
SPA

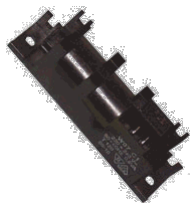

1132016 GENERAT
ORE
PIEZOELETRICO 2
VIE /
PIEZO ELECTRIC
LIGHTER
GENERATOR

40200106:
OFFCAR THE GREAT
COOKING S.R.L.
C10167: EMMEPI
GIRARROSTI GAS
CE:
CB SRL



1132017 ACCENDI
TORE 2 USCITE /
IGNITION UNIT
OUTLETS 2 230V
50Hz

RTC0700096:
MBM- EUROTEC SRL

MA2971400:

MARENO
INDUSTRIE

003376:

ELECTROLUX

051884:

ELECTROLUX

0825: FOINOX

S.P.A.

0101193: SILKO ALI

0101196: SILKO ALI

R65180290:

LAINOX ALI SPA

R65180280:

LAINOX ALI SPA

6041059: GIORIK

SPA

004240:

ELECTROLUX

MA2971400: SILKO

SIR0101193:

LAINOX

SIR0101193: SILKO

RTBF800129:

MBM- EUROTEC SRL



1132011 ACCENSI
ONE ELETTRONICA 4
FUOCHI /
ELECTRONIC TURN-
ON 4 FIRES

054134:
ELECTROLUX



1132012 ACCENSI
ONE ELETTRONICA 6
FUOCHI /
ELECTRONIC TURN-
ON 6 FIRES



1132013 ACCENSI
ONE ELETTRONICA 8
FUOCHI /
ELECTRONIC TURN-
ON 8 FIRES



1113090 PRESSOST
ATO
ACQUA+CAPPUCCIO
0,2-3 BAR /
WATER PRESSURE
SWITCH + CAP

3041830:

ANGELO PO
GRANDI CUCINE
SPA



1113134 KIT
PRESSOSTATO ARIA
HUBA /
KIT AIR PRESSURE
SWITCH HUBA

6300569:

ANGELO PO
GRANDI CUCINE
SPA



1113123 "PRESSOS
TATO: GP600" /
PRESSURE SWITCH;
GP600

0C6217:

ELECTROLUX
PROFESSIONAL
S.P.A.



1113144 "PRESSOS
TATO; 0,3-0,8 BAR;
250V" /
STEAM PRESSURE
SWITCH 0,3-0,8 BAR

0C3190EX:

ELECTROLUX
0A2480:
ELECTROLUX



1113122 REGOLAT
ORE PRESSIONE
FGMD MW5208001 /
PRESSURE
REGULATOR FGMD
MW5208001
RTFOC00624:
MBM- EUROTEC SRL
- DIV. COOKING
SERVICE



1113107 "PRESSOS
TATO ACQUA 1/8"
0,5-0,35 BAR" /
"PRESSURE SWITCH
1/8" 0,5-0,35 BAR"
R63070050:
LAINOX ALI SPA
LAR63070050: OLIS
LAR63070050:
LAINOX ALI SPA



1113110 PRESSOST
ATO BECK 901-11 /
PRESSURE BECK 901-
11
CR0587800:
MARENO
INDUSTRIE ALI
SPA
CR0587800:
SILKO ALI SPA



1113100 PRESSOST
ATO PG 901.61 /
PRESSURE SWITCH
PG 901.61
LAR63070010:
LAINOX ALI SPA
LAR63070010:
OLIS DIVISIONE
DI ALI GROUP SPA
R63070010:
LAINOX ALI SPA



1113108 PRESSOST
ATO GAS
REGOLABILE 10 - 50 /
GAS PRESSURE
SWITCH 10 - 50
0360002: SIT



1112145 BUZZER
50"APO /
BUZZER 50"APO
32Z5860:
ANGELO PO
GRANDI CUCINE
SPA



1114177 SCHEDA
ELETTR. FORNI /
P.C.BOARD FOR
OVEN
32V6151:
ANGELO PO
GRANDI CUCINE
SPA
32V6150:
ANGELO PO
GRANDI CUCINE
SPA
3018771:
ANGELO PO
GRANDI CUCINE
SPA



1114557 SCHEDA
ELETTRONICA
FORNI APO /
ELECTRONIC BOARD
OVENS A.PO
32V5361:
ANGELO PO
GRANDI CUCINE
SPA



1114096 CONTROL
LO ELETTRONICO
A.PO /
ELECTRONIC
CONTROL A.PO
32Z9090:
ANGELO PO
GRANDI CUCINE
SPA



1114417 SCHEDA
ELETTR. FORNI /
PC BOARD
3019021:
ANGELO PO
GRANDI CUCINE
SPA

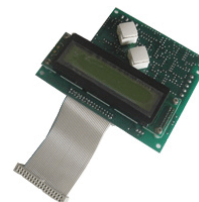

1114609 SCHEDA
LAVAVERDURE /
BOARD Vegetable
washer
32Z3030: FIMAR
S.P.A.
32Z3030:
ANGELO PO
GRANDI CUCINE
SPA

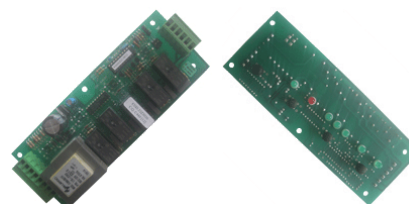

1114137 SCHEDA
DISPLAY FP
ELETTRONICI /
DISPLAY P.C. BOARD
FP
FP ELETTRONICI:
CB SRL

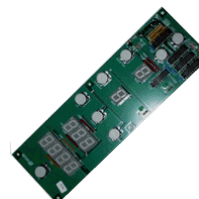

S&P Cooking Catalogue 2017

1114138 SCHEDA
ELETTRONICA 1283/1
X FP /
P.C. BOARD 1283/1 X
FP
FP ELETTRONICI:
CB SRL



1114682 SCHEDA
ELETTRONICA 2
VELOCITA' /
P.C. BOARD 2 SPEED
PR20162: FABA SRL

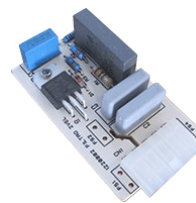

1114338 SCHEDA
ELETTRONICA;
RELEAS 1.63;
WITHOUT /
P.C. BOARD
092214:
ELECTROLUX
PROFESSIONAL
S.P.A.



1114616 P61301900
0 SCHEDA
ELETTRONICA 20V
AC 50/60Hz 16rel /
P613019000
ELECTRONIC BOARD
20V AC 50 / 60Hz 16rel
12023354: FAGOR



1114316 "SCHEDA
DI POTENZA; COP33
LIV. 4" /
"POWER P.C. BOARD
COP33 LIV. 4""
0C3762:
ELECTROLUX
PROFESSIONAL
S.P.A.

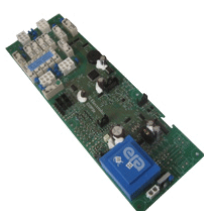

1114654 SCHEDA
ANTINFORTUNISTIC
A GRATTUGIA FAMA
BASSA TENSIONE
400V /
ELECTRONIC CARD
FOR SAFETY - LOW
VOLTAGE 400V -
GRATER FAMA
F2141:
FAMA INDUSTRIE



1114560 "SCHEDA;
COMMANDE FRY
TOP LENGHT" /
CARD LENGTH
COMMANDE
GRIDDLE"
0D6711:
ELECTROLUX

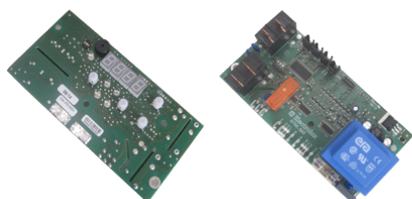

1114414 SCHEDA
ELETTRONICA
CUTTER CL 2
VELOCITA' /
P.C. BOARD CUTTER
2 SPEED
SL2514: FIMAR
S.P.A.



1114550 "SCHEDA
SPILLONE; PRB" /
PROBE CARD; PRB"
002666:
ELECTROLUX
PROFESSIONAL
S.P.A.

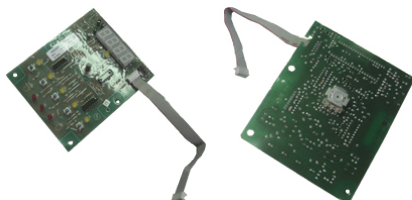

1114536 SCHEDA
ELETTRONICA 230V /
P.C. BOARD 230V
SL2997: FIMAR
S.P.A.



1114489 "VARIATO
RE DI VELOCITA';
230V 350W B3M" /
VARIABLE SPEED';
230V 350W B3M
0D5783:
ELECTROLUX

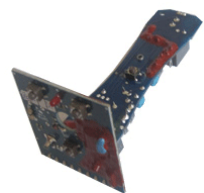

1114298 SCHEDA
DI POTENZA FOINOX
/
P.C. BOARD FOINOX
10560: FOINOX
S.P.A.



1112324 TIMER M2
2 POLI 120 MINUTI
TECNOEKA /
120 MINUTES TIMER
M2 KIT
132110014: EMMEPTI

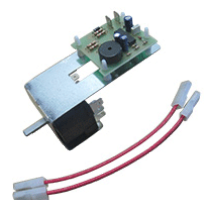

1114498 SCHEDA
POTENZA ENCODER
/
POWER BOARD
ENCODER
10600: FOINOX
S.P.A.



S&P Cooking Catalogue 2017

1112305 BUZZER
PER TIMER /
BUZZER FOR TIMER
BUZ000:
GARBIN S.R.L.



1114230 SCHEDA
TERMOREGOLATORE
E BASE MEC. /
P.C.BOARD
6010096: GIORIK
SPA



1114383 TERMOREGOLATORE
MELT.C/S. ECK256 /
ELECTRONIC
CONTROLLER
ECK256
6011142: GIORIK
SPA

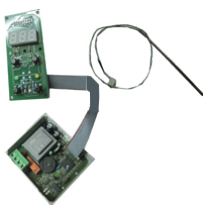

4217287 PANNELLO
SERIGRAFATO PER
MELTING 100x53 mm
/
CONTROL PLATE
ADHESIVE 100x53
mm
2018825: GIORIK
SPA



1114438 SCHEDA
CONTROLLO
VENTILATORE
BRUCIATORE /
PCB
R63130020: .
LAINOX ALI SPA
LAR63130020:
LAINOX ALI SPA



1114422 SCHEDA
CONTROLLO
VENTILATORE
BRUCIATORE /
PCB FOR COOLER
CONTROL
LAR63130050:
LAINOX ALI SPA
LAR63130050: OLIS
R63130050:
LAINOX



1114030 TASTIERA
ELETTRONICA
LAINOX MG106T /
ELECTRONIC BOARD
LAINOX MG106T
R65300200:
LAINOX ALI SPA
LAR65300200:
LAINOX ALI SPA

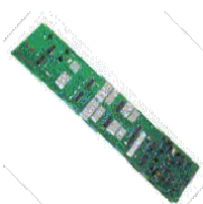

1114490 SCHEDA
CPU DGT 256K **DA
PROGRAMMARE** /
DGT 256K CPU
BOARD TO
PROGRAM
169462:
MBM- EUROTEC SRL
- DIV. COOKING
SERVICE



1114223 SCHEDA
POTENZA FGMD107
V.2002 /
MAIN PLATES
FGMD107 V.2002
RTFOC00671:
MBM- EUROTEC SRL
- DIV. COOKING
SERVICE



1114277 CENTRALI
NA SCHEDA 12V /
P.C. BOARD 12V
RC700RO:
OEM ALI SPA



1114445 SCHEDA
POTENZA
MM435+835 TRIAC
26A /
PCB
HE18500EX:
OEM ALI SPA
HE23400:
OEM ALI SPA



1114461 SCHEDA
APPAR.MOD.BZ(50PA
A78240 /
P.C. BOARD MOD. BZ
50PAA78245:
OEM ALI SPA



1114502 SCHEDA
POTENZA+CONTR.PF
-BM/8 /
POWER CONTROL
BOARD. PF-BM / 8
J5H0600:
OEM ALI SPA



1114537 SCHEDA
ELETTRONICA
TAGLIAVERDURE
AUREA /
ELECTRONIC CARD
CUT VEGETABLES
AUREA
50PAA78275:
OEM ALI SPA



1114292 SCHEDA
DI POTENZA FORNO
/
POWER BOARD
OVEN

HE158: OEM ALI
SPA
HE15800:
OEM ALI SPA

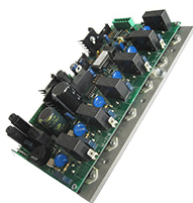

1114621 SCHEDA
MP550 ROBOT
COUPE /
PC BOARD BMP550
ROBOT COUPE

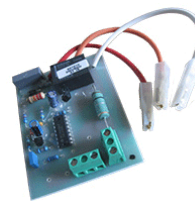

1114484 SCHEDA
AGGIUNT.F.DS+ZENI
TH M. /
ADDITIONAL CARD
F.DS ZENITH + M.

HE18600:
OEM ALI SPA



1114641 SCHEDA
ELETTRICA ROBOT
COUPE /
ELECTRIC BOARD
ROBOT COUPE



1114530 SCHEDA
POTENZA TLV/50+75
/
CARD POWER TLV/50
+75

HE17500:
OEM ALI SPA



1114522 SCHEDA
BASSA TENSIONE
230/400 V MOD. BT /
LOW VOLTAGE
BOARD 230/400 V
MOD. BT



1114366 SCHEDA
POTENZA CIELO-
PLATEA TN /
CARD POWER SKY-
STALLS TN

HE12400:
OEM ALI SPA

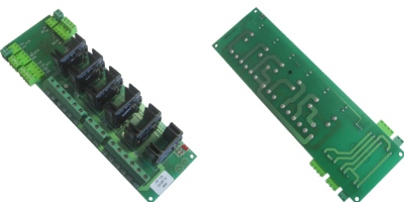

1114381 SCHEDA
SEGAOSSA
C/INVERSIONE /
PCB



1114278 SCHEDA
POTENZA FORNO
OEM /
P.C. BOARD FOR
OVEN OEM

HE14410:
OEM ALI SPA



1114229 SCHEDA
SIRMAN BASSA
TENSIONE
GRATTUGIA /
P.C.BOARD SIRMAN



1114645 SCHEDA
POTENZA F.14/8 T.N. /
P.C. BOARD F.14/8
T.N.

HE13400:
OEM ALI SPA

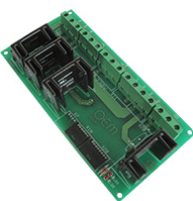

1114664 SCHEDA
TRITACARNE
OMEGA /
MEAT MINCER
CARD -OMEGA



1106717 TERMOST
ATO
EVC20S35N7ALX30 3
RELE /
THERMOSTAT
EVC20S35N7ALX30 3
RELAY

BN1681114:
SILKO ALI SPA
BN1681114:
LAINOX ALI SPA

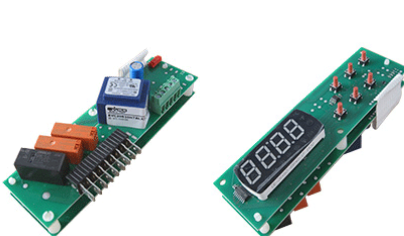

1114548 SCHEDA
BASSA TENSIONE
230/400 V MOD.
TRS98 /
CARD LOW
VOLTAGE 230/400 V
MOD. TRS98



1114585 KIT
SCHEDA POTENZA
H102 230V MC
MONOFASE /
BOARD KIT POWER
230V H102 MC-
PHASE



1114313 SCHEDA
ELETTRONICA R5
PLUS /
P.C. BOARD R5 PLUS



1114163 CENTRALI
NA SIRMAN OPALE
BASSA TENSIONE
230V /
P.C. BOARD SIRMAN

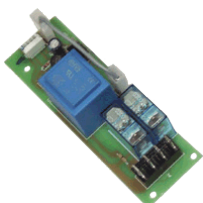

1114386 SCHEDA
AFFETTATRICE
ZENITH /
PCB ZENITH FOR
SLICER



1114619 SCHEDA
BASSA TENSIONE
230/400 V MOD.
TGOM02 /
P.C. BOARD LOW
VOLTAGE 230/400 V
MOD. TGOM02



1114582 SCHEDA
BASSA TENSIONE .
400 V MOD. TG00SR /
BOARD LOW
VOLTAGE. 400 V
MOD. TG00SR



1114575 SCHEDA
BASSA TENSIONE .
230/400 V MOD.
TGSIR01 /
CARD LOW TENSION
230/400 V MOD.
TGSIR01



1114288 SCHEDA
ELETTRONICA
AUTOREVERSE /
P.C. BOARD
AUTOREVERSE



1114289 SCHEDA
BASSA TENSIONE
SIRMAN 380V /
P.C. BOARD SIRMAN
380V

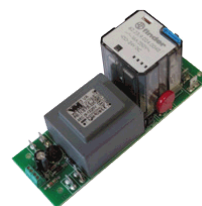

1114331 SCHEDA
AFFETTATRICE
COMPLETA DI
SCATOLETTA NERA /
P.C. BOARD FOR
SLICER

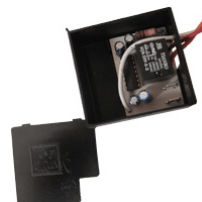

1114588 SCHEDA
BASSA TENSIONE
230 V CON
PULSANTE MOD.
TG00MINI / BOARD
LOW VOLTAGE 230V
WITH BUTTON MOD.
TG00MINI



1114061 SCHEDA
ANTINFORTUNISTIC
A 220/380V CON
CUSTODIA /
NO-ACCIDENT P.C.
BOARD 220/380V



1114380 SCHEDA
230/400V PER
INVERSIONE
C/SCATOLA E
PULSANTE /
PCB 230/400V



1114281 PULSANTI
ERA OVALE MARCIA
ARRESTO CON SPIA /
P.C. PANEL ON/OFF
WITH LED
MF2138: SIRMAN
8C1437: EMMEPI
807995: EMMEPI
OKJ019:
ELECTROLUX
PROFESSIONAL
S.P.A.
50MAA78025: OEM



1114322 PULSANTI
ERA
RETTANGOLARE
MARCIA ARRESTO
CON SPIA /
P.C. PANEL STOP
WITH LED
50MAA78001:
OEM ALI SPA



1114364 PULSANTI
ERA TRITACARNE
FIMAR CE NORMS /
PUSH BUTTON
FIMAR CE NORMS
CO0866: FIMAR
S.P.A.



1114521 PULSANTI
ERA MEMBRANA
TIPO NUOVO OMAS
CE /
PUSH BUTTON
OMAS CE



1114208 PULSANTI
ERA SIRMAN
RETTANGOLARE
120MM /
P.C.PANEL SIRMAN
120MM



1114209 PULSANTI
ERA SIRMAN
RETTANGOLARE
150MM /
P.C.PANEL SIRMAN
150MM
19702002: SIRMAN



1114219 PULSANTI
ERA SIRMAN TIPO
VECCHIO /
P.C.PANEL SIRMAN
OLD MODEL



1114310 PULSANTI
ERA SIRMAN OVALE
TIPO VECCHIO /
P.C. PANEL SIRMAN
OLD MODEL



1114124 PULSANTI
ERA OVALE SIRMAN
COMPLETA /
P.C. PANEL SIRMAN
19702004: SIRMAN



1114314 PULSANTI
ERA SIRMAN
IMPASTATRICE /
FOOD MIXER P.C.
PANEL SIRMAN



1114231 PULSANTI
ERA SIRMAN
ACCIAIO /
P.C. BOARD SIRMAN



1114395 SCHEDA
ELETTRON.COM.V /
KEYPAD PC BOARD
32Z8240:
ANGELO PO
GRANDI CUCINE
SPA



1114601 SCHEDA
ELETTRONICA
COMANDO /
ELECTRONIC
CONTROL BOARD
32V3060:
ANGELO PO
GRANDI CUCINE
SPA



1114409 PANN.SER
IG. VERT.S/APO /
KEYPAD FOIL APO
37M7330:
ANGELO PO
GRANDI CUCINE
SPA



4117220 PANNELL
O COMANDI A.PO /
COMMANDS PANEL
A.PO
37M8560: .
ANGELO PO
GRANDI CUCINE
SPA

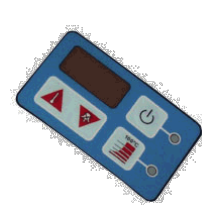

4117354 SERIGRAF
IA PANN.COMANDI
FP MANUALE /
MANUAL CONTROL
PLATE
FP MANUALI:
CB SRL



4117355 SERIGRAF
IA PANN.COMANDI
FP ELETTRONICO /
ELECTRONIC
CONTROL PLATE
FP ELETTRONICI:
CB SRL



S&P Cooking Catalogue 2017

4217126 PANNELLO FRONTALE FORNO VIP CUPPONE / FRONT PANEL OVEN VIP CUPPONE



1114437 SCHDA DISPLAY FOINOX / KEYPAD PCB
10536: FOINOX S.P.A.



1114317 SCHEDA INTERFACCIA UTENTE; UIB / CONTROL BOARD LEVEL 8
002725: ELECTROLUX PROFESSIONAL S.P.A.



1114611 TASTIERA X TERMOREGOLATORE MELT.ECK256 / KEYPAD X THERMOREGULATOR MELT.ECK256
6011142T: GIORIK SPA

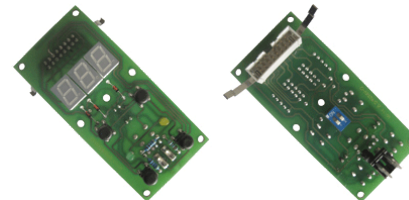

1114372 SCHEDA ELETTRONICA / CONTROL PCB
088591: ELECTROLUX PROFESSIONAL S.P.A.

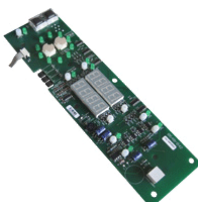

1114368 SCHEDA TASTIERA / KEYPAD PCB
R65300860: LAINOX ALI SPA

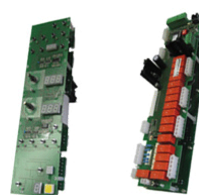

1114702 "SCHEDA INTERFACCIA UTENTE; PREC10" / P.C. BOARD PREC10
087481: ELECTROLUX PROFESSIONAL S.P.A.

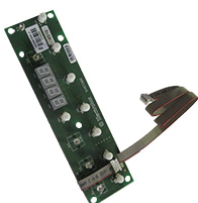

1114471 SCHEDA TASTIERA COMPLETA / KEYPAD PCB
R65301800: LAINOX ALI SPA
LAR65301800: LAINOX ALI SPA

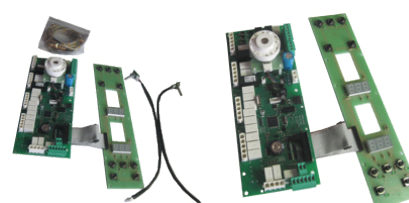

1114345 SCHEDA INTERFACCIA UTENTE / CONTROL P.C. BOARD
0C3758: ELECTROLUX PROFESSIONAL S.P.A.

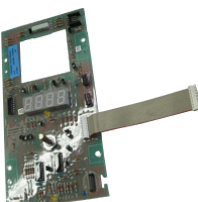

1114501 SCHEDA TASTIERA COMPLETA / KEYPAD COMPLETE
R65301400: LAINOX ALI SPA
LAR65301400: LAINOX ALI SPA

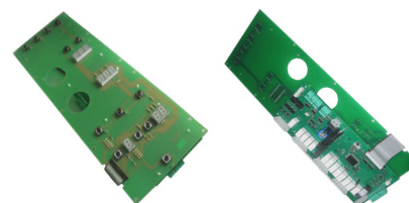

1114615 P613018000 CIRCUITO DISPLAY M / P613018000 DISPLAY CIRCUIT BOARD M
12024780: FAGOR INDUSTRIALE S.R.L.



1114296 TASTIERA / KEYPAD FOIL
50708040: LAINOX ALI SPA
R67010810: LAINOX ALI SPA
LAR67010810: LAINOX ALI SPA



1114610 ETICHETTA / LABEL
SL1505: FIMAR S.P.A.

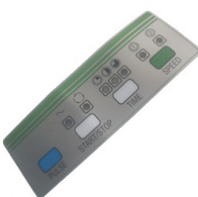

1114658 "SCHEDA ""S"" 2009 COMPLETA+ESPANSIONE" / PUSH-BUTTON PANEL ELECTR.BOARD 445x100mm
LAR65302110: LAINOX ALI SPA
*: LAINOX ALI SPA

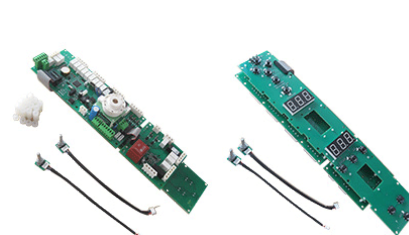

S&P Cooking Catalogue 2017

1114528 SCHEDA
EL.ENCODER
F.FEM110 /
ELECTRONIC BOARD
ENCODER F.FEM110.
164825:
MBM- EUROTEC SRL



1114460 SCHEDA
MECCANICA DS430-
435-830 /
PCB
HE18900:
OEM ALI SPA



1114370 SCHEDA
DISPLAY FGMD107
98X3 /
KEYPAD PCB
RTFOCO0672:
MBM- EUROTEC SRL
- DIV. COOKING
SERVICE



1114472 C.COMAN
DI DIG.F.S.2000E TP.N
/
SWITCH PANEL
HE12810:
OEM ALI SPA



1114647 SCHEDA
ELETTRONICA
COMANDI
DGT.FEM110 /
ELECTRONIC BOARD
CONTROLS
DGT.FEM110
164793: MBM

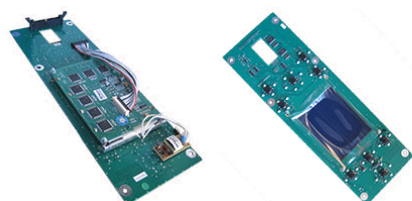

1114448 C.PANN.T
AST+MICROPR+SUPP
.TP.N. /
CONTROL PANEL
HE12500:
OEM ALI SPA

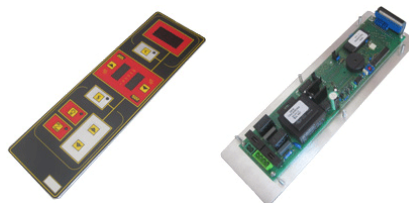

1114662 SCHEDA
DISPLAY LCD+CAVO
ZEN.D. /
CARD DISPLAY LCD
+ CABLE ZEND.
HE18800:
OEM ALI SPA

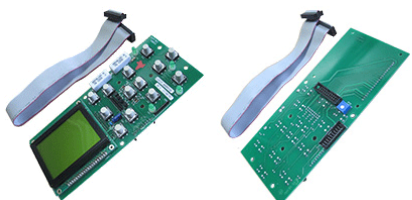

1114583 SUPPORT
O ALLUMINIO
TARGA+SCCHEDA
DISPL.TLV /
SUPPORT PLATE
ALUMINUM CARD +
DISPL.TLV
HE17920:
OEM ALI SPA



1114687 PANNELLO
COMANDI+DISPLAY
+P.ALL+TARGA
NERA /
SWITCH PANEL + PC
BOARD
HE21700:
OEM ALI SPA

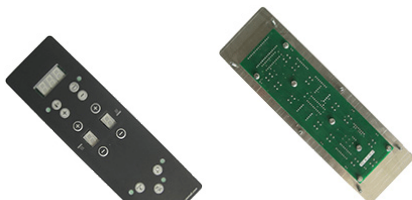

DIMENSIONS
280X85mm

1114686 ENCODER
/
ENCODER
50.00108 :
OEM ALI SPA



L=2100mm,
GUARNIZIONE=59X
51X0,5mm

1114663 TARGA
DIGITALE ZENITH
NERA TN /
DIGITAL PLAQUE
ZENITH BLACK NT
AM50100:
OEM ALI SPA



1114465 CONTROL
LO COMBUSTIONE /
INICION BOX RV
CONSTRUCTIONS
ELECTRIQUES TYPE
0526
32V5851: ANGELO
PO



1114685 PANNELLO
COM+DISPLAY
S2000+PJ /
CONTROL PANEL
WITH DISPLAY
S2000+PJ
HE15900:
OEM ALI SPA



1114479 CENTRALI
NA BRAHMA CM11F /
IGNITION BOX
BRAHMA CM11F
37100204: BRAHMA
BN3103675: OLIS



1114158 EFD X
TANDEM: 2 EL., TW
1,5,TS 10,STATO DI
BLOCCO NON
VOLATIL /
EFD X TANDEM: 2
EL., TW 1,5,TS 10,
005898:
ELECTROLUX
PROFESSIONAL
S.P.A.
7020085: GIORIK
SPA



R723032:
FAGOR
INDUSTRIALE

1114185 CENTRALI
NA BRAHMA CE11 /
P.C. BOARD
BRAHMA CE11
RTFOC00305:
MBM- EUROTEC SRL
175780:
MBM- EUROTEC
SRL



1114432 CENTRALI
NA BRAHMA CE11F /
AUTOMATIC GAS
STOKER BRAHMA
CE11F
37101207: BRAHMA



1114295 PANNELLO
ACCENSIONE /
AUTOMATIC GAS
STOKER
S4565AF1007:
HONEYWELL
R63060100:
GIGA GRANDI
CUCINE
R63060100:
LAINOX ALI SPA
LAR63060100:
LAINOX ALI SPA



4146064 VALVOLA
CM11 BRAMHA /
VALVE CM11
BRAMHA
809878:
EMMEPI GRANDI
CUCINE S.R.L.



1114299 CENTRALI
NA GAS S4565C1116 /
AUTOMATIC GAS
STOKER S4565C1116
11016: FOINOX
S.P.A.
R63060120:LAINOX
LAR63060120:LAINOX
OX
LAR63060160: OLIS
LAR63060120:
SILKO ALI SPA



1114434 SCHEDA
CONTROLLO
INVERSIONE /
CONTROL BOARD
INVERSION
6010084: GIORIK
SPA



1114433 CENTRALI
NA HONEYWELL
S4560C /
AUTOMATIC GAS
STOKER
HONEYWELL S4560C
S4560C1053:
HONEYWELL



1114315 2+1 EL.,
TW 1,5, TS 10,
BLOCCO NON
VOLATILE, /
AUTOMATIC GAS
STOKER 2-1 EL, TW
1,5, TS 10
0537001: SIT
11010: FOINOX
S.P.A.

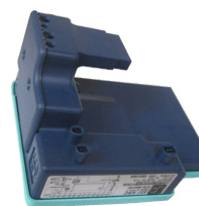

1114183 CENTRALI
NA GAS
HONEYWELL S4560M
1010 /
P.C. BOARD
HONEYWELL S4560
S4560M1010:
HONEYWELL
002641:
ELECTROLUX



1114424 CENTRALI
NA CONTROLLO 579
DBC /
AUTOMATIC GAS
STOKER
0C4260:
ELECTROLUX
0579414: SIT



1114580 R72303200
0 ELECTRONICA
50A72-250** /
R723032000
ELECTRONIC BOX
50A72-250**
12016800:
FAGOR
INDUSTRIALE



1114517 DISPOSITI
VO CONTROLLO
FIAMMA /
FLAME CONTROL
DEVICE
005924:
ELECTROLUX
PROFESSIONAL
S.P.A.



1114608 DISPOSITI
VO CONTROLLO
FIAMMA /
FLAME CONTROL
DEVICE
0C8189:
ELECTROLUX
PROFESSIONAL
S.P.A.



1114599 SCHEDA
DI CONTROLLO 537
ABC /
CONTROL BOARD
537 ABC



1114286 537 ABC
TYPE DMT - VERS.IP
40 /
AUTOMATIC GAS
STOCKER TYPE DMT

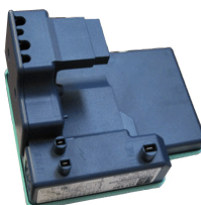

1114691 SCHEDA
ELETTRONICA DI
POSIZIONAMENTO
PER F79 /
F79 POSITIONING
P.C. BOARD



1114130 REGOLAT
ORE ELETR.
PRESSIONE
EASYPRESS 16A
12m3/h /
PRESSURE ELECTR.
REGULATOR
EASYPRESS 8A
10m3/h



1114464 CENTRALI
NA GAS
VR4605CA1126 /
GAS VALVE
VR4605CA1126
VR4605CA1126:
HONEYWELL

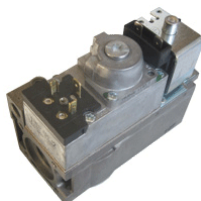

4102001 CANDELA
TONDA M.4 X
PILOTA 160 /
ROUND CANDLE M.4
X PILOT 160

RTC900010:
MBM- EUROTEC
SRL-
0915015: SIT
537003000: LOTUS
MA1949900:
MARENO
INDUSTRIE ALI
SPA
5062606677:AMBAC
H
1949900: SILKO
ALI
22296900:
BERTO'S SPA
MA1949900:SILKO
61010087:
GIORIK SPA
C00173:
EMMEPI GRANDI
CUCINE S.R.L.



4102006 CANDELA
M4 X PILOTA
TARGET 140/150 /
CANDLE M4 X PILOT
TARGET 140/150
0915024: SIT



4102015 CANDELA
QUADRA
ATT.FASTON /
SQUARE CANDLE
WITH FASTON
GIRARROSTI A
GAS:
CB SRL



4102020 CANDELA
JUNKERS /
CANDLE JUNKERS
636700:

SILKO ALI SPA
MA636700:
MARENO
INDUSTRIE ALI
SPA
MA636700:
OLIS DIVISIONE
DI ALI GROUP SPA
-
MA636700:
SILKO ALI SPA



4102009 CANDELA
M 2,4 X PILOTA
TARGET NUOVO
140/150 /
CANDLE M 2,4 X
PILOT NEW TARGET
140/150
0915025: SIT



4102010 CANDELA
M 2,4 X PILOTA 0160 /
CANDLE M 2,4 X
PILOT 0160
0915035: SIT

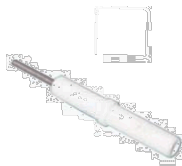

4102005 CANDELA
M 4 X PILOTA 0100 /
CANDLE M 4 X PILOT
0100
RTC900073:
MBM- EUROTEC SRL
-
RTC800109:
MBM- EUROTEC SRL
-

0915036: SIT
69000022:
RANCILIO SPA
MA1888300:
MARENO
5062607632: AMBAC
H
1888300: SILKO
ALI
6010046: GIORIK
SPA
MA224211: OLIS
MA224211:
MARENO
MA224211:
SILKO ALI SPA
MA1888300: OLIS
MA1888300:
SILKO ALI SPA



4102011 CANDELA
M 2,4 X PILOTA 0100 /
CANDLE M 2,4 X
PILOT 0100
RTCP800033:
MBM- EUROTEC SRL
- DIV. COOKING
SERVICE
0915037: SIT
BN6A013302:
OLIS DIVISIONE
DI ALI GROUP SPA
-
054336:
ELECTROLUX
PROFESSIONAL
S.P.A.
0C3195:
ELECTROLUX
PROFESSIONAL



S.P.A.

4102012 CANDELE
TTA ACCENSIONE
A.PO /
IGNITION CANDLE
A.PO
32T0010:
ANGELO PO
GRANDI CUCINE
SPA

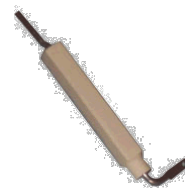

4102035 CANDELE
TTA ACCENSIONE
FORNO GN2/1 /
GLOW PLUG
IGNITION OVEN GN2
/ 1
31187000:
BERTO'S SPA



4102051 KIT
CANDELETTA
ACCENSIONE /
CANDLE IGNITION
KIT
6300567:
ANGELO PO
GRANDI CUCINE
SPA



4102039 CANDELE
TTA PER
ACCENSIONE FORNO
GN 1/1 /
CANDLE IGNITION
OVEN GN 1/1
22296500:
BERTO'S SPA



4102016 CANDELE
TTA FILETTATA
COMPLETA CB /
COMPLETE CANDLE
CB
GRIGLIE I-GC: CB
SRL

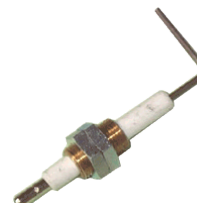

4102003 CANDELA
PER FORNO ZANUSSI
002638 /
IGNITION
ELECTRODE
ZANUSSI 002638
002638:
ELECTROLUX
PROFESSIONAL
S.P.A.



4102004 CANDELA
PER FORNO ZANUSSI
002637 /
CANDLE FOR OVEN
ZANUSSI 002637
002637:
ELECTROLUX
PROFESSIONAL
S.P.A.



S&P Cooking Catalogue 2017

4102017 "CANDEL
A ACCENSIONE; DIA
9 L=60 MM" /
IGNITION
ELECTRODE D. 9
L=60 MM
0H6803:
ELECTROLUX
PROFESSIONAL
S.P.A.



4102053 "CANDEL
A ACCENSIONE E
RILEV.; L=380MM" /
IGNITION AND
DETECTION
ELECTRODE
0C4462:
ELECTROLUX
PROFESSIONAL
S.P.A.



GASKET=2102579

4102043 CANDELA
RILEVAZIONE
FIAMMA /
SPARK FLAME
DETECTION
0C7418:
ELECTROLUX
PROFESSIONAL
S.P.A.



4102042 "CANDEL
A ACCENSIONE E
RILEVAZIONE
L=240MM" /
CANDLE IGNITION
AND DETECTION L =
240MM"
0C4461:
ELECTROLUX
PROFESSIONAL
S.P.A.



4102044 CANDELA
ACCENSIONE /
SPARK POWER
0C7419:
ELECTROLUX
PROFESSIONAL
S.P.A.



4102048 ELETTRO
DO ACCENSIONE
GFP PIEGATO /
IGNITION
ELECTRODE BENT -
GFP
00027231:
ELFRAMO SPA



4102018 CANDELA
; DIA 5/8X52 MM /
CANDLE D.
5/8X52MM
054099:
ELECTROLUX
PROFESSIONAL
S.P.A.



4102049 ELETTRO
DO PRESSIONE
FIAMMA GFP
PIEGATO /
IGNITION
ELECTRODE BENT -
GFP
00027232:
ELFRAMO SPA



4102034 ELETTRO
DO ACCENSIONE /
IGNITION
ELECTRODE
005920:
ELECTROLUX
PROFESSIONAL
S.P.A.



4102023 CANDELE
TTA
ACCENSIONE/RILEV
AMENTO /
IGNITION
ELECTRODE
11007: FOINOX
S.P.A.
25297600:
BERTO'S SPA
11001: FOINOX
S.P.A.



4102052 ELETTRO
DO /
ELECTRODE
005911:
ELECTROLUX
PROFESSIONAL
S.P.A.



4102033 ELETTRO
DO /
ELECTRODE
005910:
ELECTROLUX
PROFESSIONAL
S.P.A.



4102021 CANDELA
RILEVAZIONE
FIAMMA /
MONITORING
ELECTRODE
2012110: GIORIK
SPA



4102045 CANDELA
ACCENSIONE /
CANDLE IGNITION
LAR63050340:
LAINOX ALI SPA



4102050 CANDELA
RILEVAMENTO
FIAMMA L165MM /
SPARK FLAME
DETECTION L165MM



4102046 CANDELA
RILEVAZIONE /
DETECTION CANDLE
LAR63050350:
LAINOX ALI SPA



4102038 CANDELE
TTA + MOLLA l=600
mm /
CANDLE IGNITION +
SPRING l = 600 mm
31187800:
BERTO'S SPA



4102047 ELETTR
DO ACCENS.D.9,5
C/FL.2F /
ROUND SPARKING
PLUG ø 9.5 mm
GA29900:
OEM ALI SPA



4102013 CANDELE
TTA + CAVO FABA /
CANDLE + CABLE
FABA
PR3G033: FABA SRL



4102029 ELETTR
DO C/STAFFA
PIEG.OEM /
IGNITION
ELECTRODE OEM
GA01410:
OEM ALI SPA



4102014 CANDELA
CON CAVO L.550
S900N /
CANDLE WITH
CABLE L.550 S 900N
X14500:
GIGA GRANDI
0100834:
SILKO ALI SPA
9300542:
SILKO ALI SPA



4102026 CANDELA
RILEVAZIONE
FIAMMA /
DETECTION
ELECTRODE



4102041 ELETTR
DO RILEVAMENTO
FIAMMA.FORNO \$\$ /
FLAME DETECTION
ELECTRODE OVEN
\$\$
BN3104900:
OLIS DIVISIONE
DI ALI GROUP SPA
-



4102031 ELETTR
DO ACCENSIONE /
IGNITION
ELECTRODE



TERMOCOPPIE / THERMOCOUPLES



S&P CODE	LUNGHEZZA L LENGHT L	FILETTO GIUNTO Ø THREAD Ø	TYPE	S&P CODE	LUNGHEZZA L LENGHT L	FILETTO GIUNTO Ø THREAD Ø	TYPE
4101101	320mm	Ø= 8X1	A	4101094	1200mm	Ø= 9X1	A
4101052	450mm	Ø= 8X1	A	4101089	1500mm	Ø= 9X1	A
4101090	600mm	Ø= 8X1	A	4101027	400mm	Ø= 11/32 ASA	A
4101085	850mm	Ø= 8X1	A				
4101091	1000mm	Ø= 8X1	A	4101106	320mm	Ø= 8X1	B
4101086	1200mm	Ø= 8X1	A	4101104	600mm	Ø= 8X1	B
4101071	1500mm	Ø= 8X1	A	4101040	1000mm	Ø= 8X1	B
4101016	320mm	Ø= 9X1	A	4101095	1200mm	Ø= 8X1	B
4101030	400mm	Ø= 9X1	A	4101039	1500mm	Ø= 8X1	B
4101004	500mm	Ø= 9X1	A	4101020	320mm	Ø= 9X1	B
4101067	500mm	Ø= 9X1 NICHELATA	A	4101055	500mm	Ø= 9X1	B
4101007	600mm	Ø= 9X1	A	4101021	600mm	Ø= 9X1	B
4101005	750mm	Ø= 9X1	A	4101033	1000mm	Ø= 9X1	B
4101088	850mm	Ø= 9X1	A	4101061	1200mm	Ø= 9X1	B
4101008	1000mm	Ø= 9X1	A	4101056	1500mm	Ø= 9X1	B

TERMOCOPPIE INTERROTTE/ THERMOCOUPLES INTERRUPTED



S&P CODE	LUNGHEZZA L LENGHT L	FILETTO GIUNTO Ø THREAD Ø	FASTON	TYPE	S&P CODE	LUNGHEZZA L LENGHT L	FILETTO GIUNTO Ø THREAD Ø	TYPE
4101023	600mm	Ø= 9X1	SI - YES	C	4101110	600mm	Ø= 9X1	D
4101077	600mm	Ø= 9X1	NO	C	4101087	1000mm	Ø= 9X1	D
4101010	1000mm	Ø= 9X1	NO	C	4101108	1000mm	Ø= 9X1	D

TERMOCOPPIE UNIVERSALI / UNIVERSAL THERMOCOUPLES



E



F

S&P CODE	LUNGHEZZA L LENGHT L	FILETTO GIUNTO Ø THREAD Ø	TYPE
4101019	900mm	UNIVERSALE	E
4101025	1200mm	UNIVERSALE	E
4101100	1500mm	UNIVERSALE	E

S&P CODE	LUNGHEZZA L LENGHT L	FILETTO GIUNTO Ø THREAD Ø	TYPE
4101009	900mm	UNIVERSALE	F
4101018	1200mm	UNIVERSALE	F

TERMOCOPPIE SPECIALI / SPECIAL THERMOCOUPLES



G

GIUNTO SPECIALE
SPECIAL JOINT

S&P CODE	LUNGHEZZA L LENGHT L	FILETTO GIUNTO Ø THREAD Ø	TYPE
4101003	1000mm	Ø= 9X1	G



H

GIUNTO SPECIALE INTERRUPTO
SPECIAL JOINT INTERRUPTED

S&P CODE	LUNGHEZZA L LENGHT L	FILETTO GIUNTO Ø THREAD Ø	TYPE
4101034	1000mm	Ø= 9X1	H

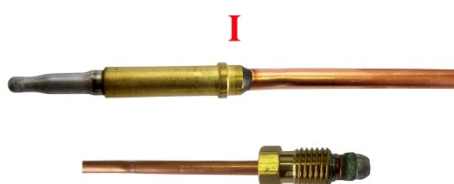

I

GIUNTO AD ANELLO
RING JOINT

S&P CODE	LUNGHEZZA L LENGHT L	FILETTO GIUNTO Ø THREAD Ø	TYPE
4101093	600mm	Ø= 8X1	I
4101026	750mm	Ø= 8X1	I



L

GIUNTO SPECIALE FABA
SPECIAL JOINT FABA

S&P CODE	LUNGHEZZA L LENGHT L	FILETTO GIUNTO Ø THREAD Ø	TYPE
4101064	750mm	Ø= 9X1	I
4101045	600mm	Ø= 8X1	L

M

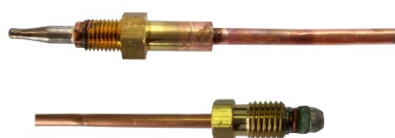

**GIUNTO SPECIALE
SPECIAL JOINT**

S&P CODE	LUNGHEZZA L LENGHT L	FILETTO GIUNTO Ø THREAD Ø	TYPE
4101109	600mm	Ø= 9X1	M

N



**GIUNTO SPECIALE
SPECIAL JOINT**

S&P CODE	LUNGHEZZA L LENGHT L	FILETTO GIUNTO Ø THREAD Ø	TYPE
4101047	600mm	Ø= 9X1	N

TERMOCOPPIE SPECIALI / SPECIAL THERMOCOUPLES

O



**GIUNTO SPECIALE TARGET
SPECIAL JOINT TARGET**

S&P CODE	LUNGHEZZA L LENGHT L	FILETTO GIUNTO Ø THREAD Ø	TYPE
4101051	1500mm	Ø= 9X1	O

P



**GIUNTO SPECIALE INTERRUPTO
SPECIAL JOINT INTERRUPTED**

S&P CODE	LUNGHEZZA L LENGHT L	FILETTO GIUNTO Ø THREAD Ø	TYPE
4101053	1000mm	Ø= 9X1	P

Q



**GIUNTO SPECIALE SLEEVE
SPECIAL SLEEVE JOINT**

S&P CODE	LUNGHEZZA L LENGHT L	FILETTO GIUNTO Ø THREAD Ø	TYPE
4101072	750mm	Ø= 8X1	Q

R



**TERMOCOPPIA FLESSIBILE
FLEXIBLE THERMOCOUPLE**

S&P CODE	LUNGHEZZA L LENGHT L	FILETTO GIUNTO Ø THREAD Ø	TYPE
4101066	900mm	Ø= 9X1	R

S



**TERMOCOPPIA CON GIUNZIONE CAVI
THERMOCOUPLE WITH FASTON
CONNECTION**

S&P CODE	DIMENSIONI Ø DIMENSIONS Ø	LUNGHEZZA CAVO L LENGHT CABLE L	TYPE
4101107	Ø= 6X34mm	750mm	S

T



**TERMOCOPPIA SPECIALE - TIPO J
SPECIAL THERMOCOUPLE - TYPE J**

S&P CODE	DIMENSIONI Ø DIMENSIONS Ø	LUNGHEZZA CAVO L LENGHT CABLE L	TYPE
4101041	Ø= 10X72mm	600mm	T

TERMOGENERATORI / THERMOPILES

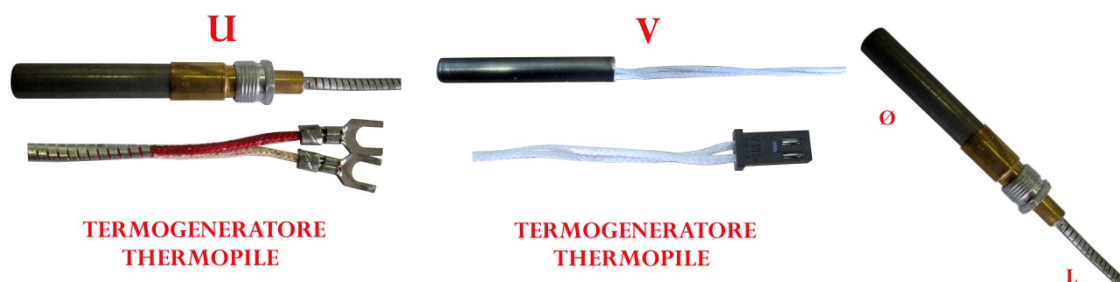

CODICE S&P S&P CODE	DIMENSIONI Ø DIMENSIONS Ø	LUNGHEZZA CAVO L LENGHT CABLE L	TYPE
4101075	Ø= 9X75mm	580mm	U
4101011	Ø= 9X75mm	900mm	U
4101081	Ø= 6X40mm	2500mm	V

ACCESSORI / ACCESSORIES



RACCORDO
FRESATO /
SLOTTED FITTING

S&P CODE	FILETTO GIUNTO Ø THREAD Ø
4101057	M8X1
4101059	M9X1
4101058	M10X1
4101078	11/32 ASA



RACCORDO
INTERROTTO /
INTERRUPTED JOINT

S&P CODE	FILETTO GIUNTO Ø THREAD Ø
4101036	M8X1
4101037	M9X1

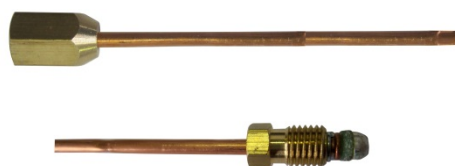

PROLUNGA TERMOCOPPIA
THERMOCOUPLE EXTENSION



DADO PER TERMOCOPPIA /
NUT FOR THERMOCOUPLE

S&P CODE	LUNGHEZZA L LENGHT L	FILETTO GIUNTO Ø THREAD Ø
4101046	600mm	M9X1
4101084	1000mm	M10X1

S&P CODE	GIUNTO THREAD
1141050	FILETTATO

4101074 TERMOCO
PPIA 750MM CUCINA
E /
THERMOCOUPLE
750MM
31289200:
BERTO'S SPA



4101105 TERMOCO
PPIA BIFILARE-
L=750MM-KW 3,2 /
THERMOCOUPLE
FASTON
CONNECTION 750mm
C10334:
**EMMEPI GRANDI
CUCINE S.R.L.**



Ø=6mm

4101079 "TERMOC"
"J" D.2X250+CAVO
1,5MT" /
THERMOCOUPLE "J"
D.2X250+KABLE
1,5MT
ED06500:
OEM ALI SPA



4101080 TERMORE
S.D.3X250+CAVO
2MT+CONN /
THERMOELEMENT
D.3X250+KABLE 2MT
ED08320:
OEM ALI SPA



4103016 CORPO
PILOTA CON
UGELLO D. 0,20 GPL /
PILOT BODY WITH
NOZZLE D. 0,20
0901067: SIT
BN2510359:
**OLIS DIVISIONE
DI ALI GROUP SPA**
-
X19900:
**GIGA GRANDI
CUCINE SRL**



4103015 CORPO
PILOTA UGELLO D.
0,25 /
PILOT BODY WITH
NOZZLE D. 0,25
SIR0101152:
**MARENO
INDUSTRIE ALI
SPA**
0101152:
**MARENO
INDUSTRIE ALI
SPA**
0901210: SIT
0101152:



SILKO ALI SPA
SIR0101152:
SILKO ALI SPA

4103004 CORPO
PILOTA C/UGELLO
0,35 METANO /
PILOT BODY WITH
NOZZLE 0,35
MA1314800:
**MARENO
INDUSTRIE ALI
SPA**



4103025 CORPO
PILOTA D. 0,40
MARENO /
BODY PILOT D. 0.40
MARENO
MA1874100:
SILKO ALI SPA
0901405: SIT
MA1874100:
**MARENO
INDUSTRIE ALI
SPA**



4103020 CORPO
BRUCIATORE
PILOTA 33A0200 /
PILOT BURNER
BODY 33A0200
33A0200EX:
**ANGELO PO
GRANDI CUCINE
SPA**
33A0690:
**ANGELO PO
GRANDI CUCINE
SPA**

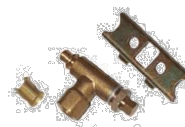

4217152 CORPO
PILOTA CUCINE ECO
POWER-L /
BODY PILOT
KITCHENS ECO
POWER-L
24291600:
BERTO'S SPA

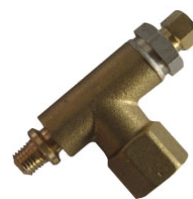

4103094 CORPO
BRUCIATORE
PILOTA /
BODY PILOT
BURNER
006725:
**ELECTROLUX
PROFESSIONAL
S.P.A.**



S&P Cooking Catalogue 2017

4103034 DEFLETT
ORE 1 FIAMMA PIL
0100 /
PILOT DEFLECTOR 1
FLAME 0100



4103093 CANNELL
O PILOTA /
TORCH PILOT
0A5441:
ELECTROLUX
PROFESSIONAL
S.P.A.



burner=4103094

4103009 DEFLETT
ORE 2 FIAMME PIL.
0100 /
PILOT DEFLECTOR 2
FLAMES 0100
0975016: SIT



4103002 PILOTA 1
FIAMMA 0100013 0,20
/
PILOT 1 FLAME
0100013
31291300:
BERTO'S SPA
31291400:
BERTO'S SPA
0100821*:
SILKO ALI SPA

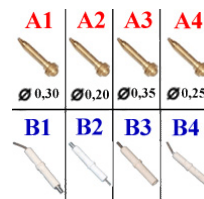

A1=4105032, A2=4105033
A3=4105034, A4=4105035
B1=4102005, B2=4102006,
B3=4102009, B4=4102011

4103008 DEFLETT
ORE 3 FIAMME PIL.
0100 /
PILOT DEFLECTOR 3
FLAMES 0100
0975004: SIT
7090002: GIORIK
SPA
33A1081:
ANGELO PO
GRANDI CUCINE
SPA



4103055 PILOTA 1
FIAMMA CON
REGOLAZIONE /
PILOT 1 FLAME
WITH REGULATION
G1807122: SIT
RTC900025:
MBM- EUROTEC
SRL - DIV.
COOKING SERVICE

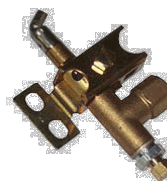

4103022 CAPPUCCI
O DEFLETTORE
33A1070 /
DEFLECTOR
PROTECTION 33A170
33A1070:
ANGELO PO
GRANDI CUCINE
SPA



4103018 PILOTA
ZANUSSI 1 FIAMMA
D. 0,3 /
SPECIAL PILOT 1
FLAME D. 0,3
0190904: SIT



= 4105046, = 4105095

4103024 ASSIEME
CANNELLO PILOTA
MARENO /
TORCH ASSEMBLY
PILOT MARENO
12009152:
FAGOR
INDUSTRIALE
S.R.L.
MA1576000:
MARENO
INDUSTRIE ALI
SPA
MA1576000:
SILKO ALI SPA



4103075 PILOTA
SPECIALE 1 FIAMMA
PER CUCINE ,
UG.D.0,18 SENZA
RACCBI /
PILOT 1 FLAME
NOZZLE 0,18
0190901: SIT



4105046

4103074 KIT
PIL.M.V. 1 VIA 0,35 /
PILOT 1 FLAME
NOZZLE 0,35
RTC700372:
MBM- EUROTEC
SRL - DIV.
COOKING SERVICE
GK803MBM: SIT



gpl= 4105058,
metano= 4105042

4103085 CANNELL
O PIL.GF47 /
PIPE PIL. GF47
RGCU700571:
MBM- EUROTEC
SRL - DIV.
COOKING SERVICE
RTC700571:
MBM- EUROTEC
SRL - DIV.
COOKING SERVICE



S&P Cooking Catalogue 2017

4103086 PILOTA
BRUCIATORE GICO /
PILOT BURNER GICO
A00001: GICO SPA



4103063 PILOTA
ACCENSIONE 3 VIE
CB /
PILOT 3 FLAMES CB
GRIGLIA BEX-MEX-
I E GIRARROSTI:
CB SRL

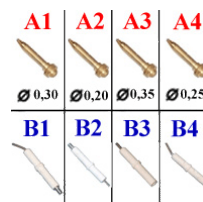

A1=4105032, A2=4105033
A3=4105034, A4=4105035
B1=4102005, B2=4102006,
B3=4102009, B4= 4102011

4103013 PILOTA
DEFLETTORE 2
FIAMME /
PILOT DEFLECTOR 2
FLAMES
0100020: SIT
61801232: SIT
94400: MARENO
BN6A013105:
OLIS DIVISIONE
DI ALI GROUP SPA
-



A1=4105032, A2=4105033
A3=4105034, A4=4105035
B1=4102005, B2=4102006,
B3=4102009, B4= 4102011

4103100 PILOTA
SPECIALE 3 Fiamme,
Ug. D.0,35, RaccBic
D.4 /
PILOT SPECIAL
Flames 3, Ug. D.0.35,
ECR Bic D.4

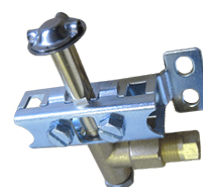

4103014 PILOTA
DEFLETTORE 3
FIAMME /
PILOT DEFLECTOR 3
FLAMES
RTC900074:
MBM- EUROTEC
SRL

MA1314500R:
MARENO
BN6A013200:
OLIS DIVISIONE

61801332: SIT
5024703475:

AMBACH
7090023:

GIORIK SPA
054335:

ELECTROLUX
C00711:

EMMEPI GRANDI
CUCINE S.R.L.

25291400:

BERTO'S SPA
0100824:

SILKO ALI SPA
R32300-X13500:

GIGA GRANDI
CUCINE SRL

R63050020-502032:

LAINOX ALI SPA

50203220:

LAINOX ALI SPA

SIR0100824:

SILKO ALI SPA

RIC0003578:

MBM- EUROTEC
SRL

12009166: FAGOR



A1=4105032, A2=4105033
A3=4105034, A4=4105035
B1=4102005, B2=4102006,
B3=4102009, B4= 4102011

4103073 PILOTA 3
FIAMMA UGELLO
0,20 RACC+BIC D. 6 /
PILOT 3 FLAMES
NOZZLE 0,20
0100025: SIT



A1=4105032, A2=4105033
A3=4105034, A4=4105035
B1=4102005, B2=4102006,
B3= 4102009, B4=4102011

4103056 GRUPPO
SPIA PILOTA APO /
PILOT A.PO
6000280:
ANGELO PO
GRANDI CUCINE
SPA

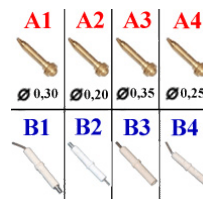

A1=4105032, A2=4105033
A3=4105034, A4=4105035
B1=4102005, B2=4102006,
B3=4102009, B4= 4102011

4103029 PILOTA
SIT 1 FIAMMA /
PILOT SIT 1 FLAME
0160002: SIT
MACM040800:
MARENO
INDUSTRIE ALI
SPA

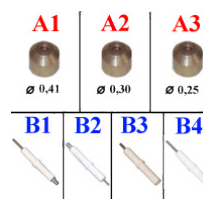
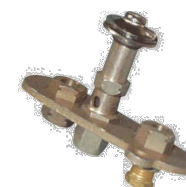

A1=4105025, A2=4105026
A3=4105047, B1=4102001,
B2=4102006, B3=4102009,
B4=4102010

MACM040800:
SILKO ALI SPA

S&P Cooking Catalogue 2017

4103036 PILOTA
STAMPATO 2
FIAMME ORIZ.
DX+RACC. TC /
HORIZONTAL PILOT
2 FLAMES

0160012: **SIT**
533011500:

LOTUS SPA
0100800-0100825:
SILKO ALI SPA

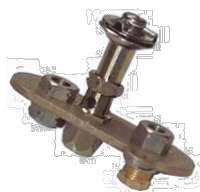

A1=4105025, A2=4105026
A3=4105047, B1=4102001,
B2=4102006, B3=4102009,
B4=4102010

4103026 PILOTA
DEFLETTORE 3
FIAMME VERTICALE

/
VERTICAL PILOT
DEFLECTOR 3
FLAMES

0160042: **SIT**
RTBF800034:
MBM- EUROTEC
SRL - DIV.
COOKING SERVICE

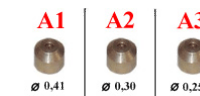
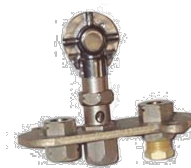

A1=4105025, A2=4105026
A3=4105047, B1=4102001,
B2=4102006, B3=4102009,
B4=4102010

4103050 PILOTA 2
FIAMME ORIZZ. SX /
PILOT 2 FLAMES
HORIZONTAL LEFT

A00281: **GICO SPA**
SIR0100799:

SILKO ALI SPA
0100799:
SILKO ALI SPA

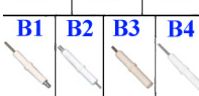

A1=4105025, A2=4105026
A3=4105047, B1=4102001,
B2=4102006, B3=4102009,
B4=4102010

4103017 PILOTA
STAMPATO 2
FIAMME OR.DX /
RIGHT PRINTED
PILOT 2 FLAMES OR.

GRCU900011:
MBM- EUROTEC
SRL - DIV.
COOKING SERVICE
00003279:

ELFRAMO SPA
RTC9000007:
MBM- EUROTEC
SRL - DIV.
COOKING SERVICE

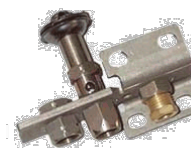

A1=4105025, A2=4105026
A3=4105047, B1=4102001,
B2=4102006, B3=4102009,
B4=4102010

4103052 PILOTA 3
FIAMME ORIZZ. /
PILOT 3 FLAMES
HORIZONTAL

0160032: **SIT**
67204200:

MODULAR SPA
RTC9000464:
MBM- EUROTEC
SRL - DIV.
COOKING SERVICE
A00282: **GICO SPA**
898969:

OFFCAR THE
GREAT COOKING
S.R.L.
27291100:

BERTO'S SPA



A1=4105025, A2=4105026
A3=4105047, B1=4102001,
B2=4102006, B3=4102009,
B4=4102010

4103051 PILOTA
STAMPATO 2
FIAMME VERT. /
PRINTED PILOT 2
FLAMES VERTICAL

4103051 PILOTA
STAMPATO 3
FIAMME
VERT.UG.GN+RACC
BIC D6+RACCTC /
PILOT 3FL

0160005: **SIT**

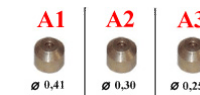

A1=4105025, A2=4105026
A3=4105047, B1=4102001,
B2=4102006, B3=4102009,
B4=4102010

4103049 PILOTA
STAMPATO 2
FIAMME VERTICALI
/

PRINTED PILOT 2
FLAMES VERTICAL
054711:

ELECTROLUX
PROFESSIONAL
S.P.A.
0160103: **SIT**

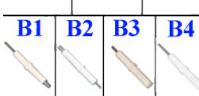
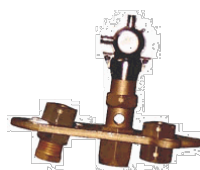

A1=4105025, A2=4105026
A3=4105047, B1=4102001,
B2=4102006, B3=4102009,
B4=4102010

4103035 PILOTA
STAMPATO 3
FIAMME
VERT.UG.GN+RACC
BIC D6+RACCTC /
PILOT 3FL

0160005: **SIT**

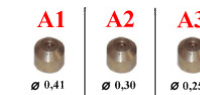
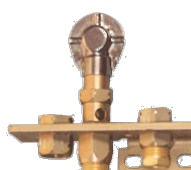

A1=4105025, A2=4105026
A3=4105047, B1=4102001,
B2=4102006, B3=4102009,
B4=4102010

4103079 PILOTA
STAMPATO 2
FIAMME
VERTI.+UG.GN+RAC
CBIC
D.6+RACCTC+FI /
PILOT 2 FLAMES
0160105: **SIT**



4103011 PILOTA
SIT 0150087 /
PILOT SIT 0150087
0150087: **SIT**



S&P Cooking Catalogue 2017

4103054 PILOTA
BUR. HP TARGET 1FL
/
PILOT TARGET 1 FL
0140026: SIT
RTPC800034:
MBM- EUROTEC
SRL - DIV.
COOKING SERVICE

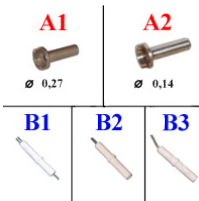
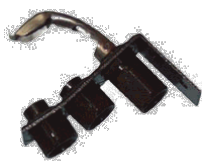

A1=4105023, A2=4105036
B1=4102006, B2=4102009,
B3=4102011

4103101 PILOTATA
RGET HP.1 FIAMMA /
TARGET ONE-
FLAME PILOT
BURNER SIT



4103062 ASSIEME
PILOTA X
BRUCIATORE GICO /
PILOT BURNER GICO
150086: SIT
A00407: GICO SPA



4103072 SPEC.
PILOTA BUR. HP /
SPECIAL BURNER
PILOT HP
0145028: SIT



4103097 PILOTA
BRUCIATORE
.TARGET 1 FIAMMA.
(GIGA) /
PILOT BURNER 1
FLAME GIGA
X14400:
GIGA GRANDI
CUCINE SRL



4103040 PILOTA
BRUCIATORE /
BURNER PILOT
0140102: SIT
059214:
ELECTROLUX
PROFESSIONAL
S.P.A.

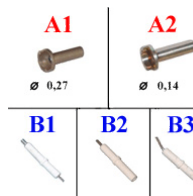

A1=4105023, A2=4105036
B1=4102006, B2=4102009,
B3=4102011

4103033 PILOTA
TARGET 1 FIAMMA
SENZA
UG.RACC.BIC.CAND
ELA /
PILOT TARGET 1
FLAME WITHOUT
NOZZLE FOR
CANDLE
0140018: SIT

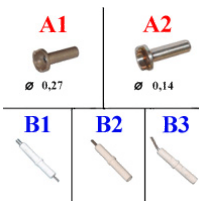

A1=4105023, A2=4105036
B1=4102006, B2=4102009,
B3=4102011

4103053 PILOTA
TARGET 2 FIAMME /
PILOT TARGET 2
FLAMES
MACM029000:
MARENO
INDUSTRIE ALI
SPA
MACM029000:
SILKO ALI SPA
0140015: SIT
67201300:
MODULAR SPA
67201400:
MODULAR SPA

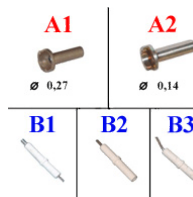
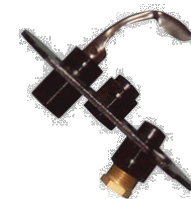

A1=4105023, A2=4105036
B1=4102006, B2=4102009,
B3=4102011

4103042 PILOTA
TARGET 1 FIAMMA
SENZA UG. RACC.
BICONO /
PILOT TARGET 1
FLAME WITHOUT
JUNCTION NOZZLE
0140028: SIT
MA1887700:
MARENO
INDUSTRIE ALI
5024716410:
AMBACH
1887700:
SILKO ALI SPA
MA1887700:
OLIS DIVISIONE
DI ALI GROUP SPA
-
MA1887700:
SILKO ALI SPA

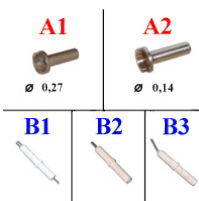
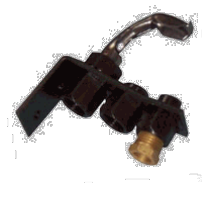

A1=4105023, A2=4105036
B1=4102006, B2=4102009,
B3=4102011

4103066 PILOTA
33A0480 /
PILOT 33A0480
33A0480:
ANGELO PO
GRANDI CUCINE
SPA
509900:
SILKO ALI SPA
MA509900:
OLIS DIVISIONE
DI ALI GROUP SPA
-
MA509900:
SILKO ALI SPA
MA509900:
MARENO
INDUSTRIE ALI
SPA

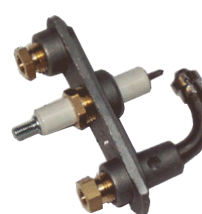

= 4105049, = 4105050

S&P Cooking Catalogue 2017

4103012 PILOTA
ZANUSSI 002783 /
PILOT ZANUSSI
002783
0190603: SIT
MA1949700:
MARENO
INDUSTRIE ALI
SPA
1949700:
MARENO
INDUSTRIE ALI
SPA
002783:
ELECTROLUX
PROFESSIONAL
S.P.A.
33120007:
ELFRAMO SPA



EMMEPI GRANDI
CUCINE S.R.L.

4103065 BRUCIAT
ORE 3 VIE P. /
PILOT 3 FLAMES



4103071 PILOTA
PLD 3 FIAMME /
PILOT 3 FLAMES

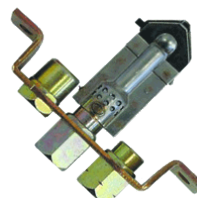

ø 0,54 = 4105107,
METANO= 4105122

4103080 PILOTA
GWT /
PILOT FOR GWT
00038491:
ELFRAMO SPA



4103027 BRUCIAT
ORE PILOTA 1
FIAMMA A.PO /
PILOT BURNER 1
FLAME A.PO



4103083 BRUCIAT
ORE PILOTA /
PILOT BURNER
0C0199:
ELECTROLUX
PROFESSIONAL
S.P.A.

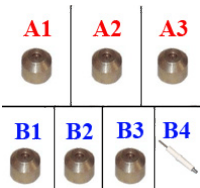

A1=4105025, A2=4105026
,A3=4105047, B1=4105066
,B2=4105072, B3=4105082
B4= 4102001

4103090 VENTURI
PILOTA /
VENTURI PILOT
MA1032501300:
MARENO
INDUSTRIE ALI
SPA
MA1032501300:
OLIS DIVISIONE
DI ALI GROUP SPA
-
MA1032501300:
SILKO ALI SPA



4103092 BRUCIAT
ORE PILOTA /
PILOT BURNER
0C3644:
ELECTROLUX
PROFESSIONAL
S.P.A.



junction=4217034

4217108 PORTAUG
ELLO ANGOLARE
PER TUBO D.10 /
Nozzle ANGLE TUBE
D.10
32327600:
BERTO'S SPA



4103078 BRUCIAT
ORE PILOTA 3 VIE /
PILOT BURNER 3
WAYS
K22029: A.T.A. SRL
054032:
ELECTROLUX
PROFESSIONAL
S.P.A.
808197:
EMMEPI GRANDI
CUCINE S.R.L.
0108109:
SILKO ALI SPA
7090026:
GIORIK SPA
C10515:



ø 0,54
= 4105107, = 4105052

4217151 CAPPELL
O PER ASSIEME
PILOTA-L /
HAT FOR PILOT
24292000:
BERTO'S SPA



4103064 GRUPPO
PILOTA COMPLETO
GRIGLIE CB I-GC /
COMPLETE PILOT
CB I-GC
GRIGLIE I-GC:
CB SRL



S&P Cooking Catalogue 2017

4103096 TUBO
VENTURI DEL
PILOTA-L /
VENTURI TUBE OF
PILOT-L
22993700:
BERTO'S SPA



4103105 PROLUNG
A PILOTA BARON
NUOVO TIPO /
PILOT EXTENSION
BARON NEW TYPE



4103041 PROTEZIO
NE PILOTA ZANUSSI
/
COVER FOR PILOT
BURNER ZANUSSI
003547:
ELECTROLUX
PROFESSIONAL
S.P.A.



4103047 SUPPORT
O SPIA PILOTA /
PILOT REST
35R3540:
ANGELO PO
GRANDI CUCINE
SPA



4103043 SUPPORT
O SPIA PILOTA A.PO'
/
PILOT REST A.PO
35V9130:
ANGELO PO
GRANDI CUCINE
SPA



4103048 SUPPORT
O SPIE PILOTA A.PO' /
PILOT REST A.PO
35R0100:
ANGELO PO
GRANDI CUCINE
SPA



4103091 ASS.SUPP
ORTO PILOTA
FRIGGITRICE /
ASSEMBLY
SUPPORT PILOT
FRYER
CRO413801:
MARENO
INDUSTRIE ALI
SPA



4103095 SUPPORT
O BRUCIATORE
PILOTA /
SUPPORT PILOT
BURNER

0C8935:
ELECTROLUX
PROFESSIONAL
S.P.A.
0C4365:
ELECTROLUX
PROFESSIONAL
S.P.A.



4117751 SUPPORT
O CANDELA /
CANDLE SUPPORT
LB83900:
SILKO ALI SPA
SIRLB83900:
SILKO ALI SPA



4117752 SUPPORT
O TERMOCOPPIA /
THERMOCOUPLE
SUPPORT
LB83800:
SILKO ALI SPA
SIRLB83800:
SILKO ALI SPA



4102032 ASS.SUPP
ORTO TERMOPILA /
ASSEMBLY
SUPPORT
THERMOPILEe
MA1953401:
MARENO
INDUSTRIE ALI
SPA
MA1953401: SILKO
ALI SPA



4103102 CANNELL
O PILOTA -AISI304 /
PILOT BURNER
33A1490:
ANGELO PO
GRANDI CUCINE
SPA



supporto=4103103

4103103 SUPPORT
O BRUCIATORE
PILOTA/ACCENSION
E /
PILOT BURNER
SUPPORT
34A2381:
ANGELO PO
GRANDI CUCINE
SPA



4103069 REGOLAT
ORE D'ARIA /
AIR MIXER FOR
PILOT BURNER
1324900:
MARENO
INDUSTRIE ALI
SPA
0912001: SIT
33A0970:
ANGELO PO
GRANDI CUCINE
SPA
7090007: GIORIK
SPA



4103089 CAPPUCCI
O BRUCIATORE
PILOTA / CAP PILOT
BURNER
MA1033717300:
MARENO
INDUSTRIE ALI
SPA
MA1033717300:
OLIS DIVISIONE
DI ALI GROUP SPA
-
MA1033717300:
SILKO ALI SPA
MA1033717300R:
MARENO
INDUSTRIE ALI
SPA



4103098 AERATO
RE PER
BRUCIATORE /
Aerator BURNER
741312350: GICO
SPA



4117299 BICONO
D.6 (PIL.0160) /
DIE RING D.6
0957015: SIT

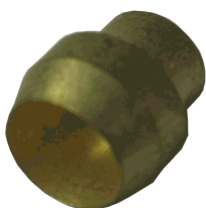

4117063 BICONO
D. 6 TARGET /
LOCKING RING FOR
IGNITION LINE D. 6
mm
RTC900183:
MBM- EUROTEC
SRL - DIV.
COOKING SERVICE
0957010: SIT



4217395 BICONO
D.6 /
OLIVE FOR 6 mm ø
PIPE
36Q0020:
ANGELO PO
GRANDI CUCINE
SPA



4117938 BICONO
D.10 /
PIPE OLIVE D.10



4117300 RACCXBI
C. D.6 M10X1 L.10,5
NOR
/ JOINT D.6 M10X1 L.
10,5 NOR



4117301 RACCXBI
C. D.4 M10X1 L.10,5
NOR /
JOINT D.4 M10X1
L.10,5 NOR
0958013: SIT
046755:
ELECTROLUX
PROFESSIONAL
S.P.A.

052125:
ELECTROLUX
PROFESSIONAL
S.P.A.
0100777:
SILKO ALI SPA
SIR0100777:
SILKO ALI SPA
MA673500:
MARENO
INDUSTRIE ALI
SPA

MA673500:
SILKO ALI SPA
RTC900037:
MBM- EUROTEC
SRL - DIV.
COOKING SERVICE
RTC900133:
MBM- EUROTEC
SRL - DIV.
COOKING SERVICE



4117750 RACCORD
O PER CANDELA /
IGNITER JOINT
0100620:
SILKO ALI SPA
SIR0100620:
SILKO ALI SPA



S&P Cooking Catalogue 2017

4117303 RACCORDO
O XBICONO D.12 3/8
RS L20 /
PIPE FITTING ϕ 12
mm



1128004 CAVETTO
MM1000 2,4-4,2
GUAINA /
CABLE MM1000 2,4-
4,2
**6050051: GIORIK
SPA**



1128033 CAVETTO
ACCENSIONE
1800MM / IGNITION
CABLE 1800MM
31189900:
BERTO'S SPA



1128005 CAVO
1000MM FASTON
D.2,4-D.2,4 /2 GUAINA
/
CABLE 1000MM
FAST D.2,4-.,2,4/2



1128034 CAVO
ACCENSIONE
PIEZOELETRICA, l=
1400 /
CABLE POWER
PIEZOELCTRIC, l =
1400
22189400:
BERTO'S SPA



1128030 CAVO
ACCENSIONE /
IGNITION CABLE



1128027 CAVO
ACCENSIONE CON
OCCHIELLO M4
L=600MM /
POWER CABLE WITH
EYE M4 L = 600MM
22189200:
BERTO'S SPA



1128031 CAVO
RILEVAMENTO /
IGNITION CABLE



1128019 FILO PER
ACC. PIEZO /
CABLE FOR PIEZO
ELECTRIC LIGHTER
**GRIGLIE TUTTI I
MODELLI: CB SRL**



1128028 ASS.
CAVETTI PER
CANDELE / IGNITION
CABLE
006023:
**ELECTROLUX
PROFESSIONAL
S.P.A.**



1128020 CAVO
AT.900mm /
CABLE 900mm
**GIARROSTI GAS:
CB SRL**



1114222 CONNETT
ORE SCHEDA EL.4
P.+MORS /
PCB CONNECTOR
RTFOC00593:
**MBM- EUROTEC SRL
- DIV. COOKING
SERVICE**



1128001 CAVO
ACCENSIONE
1000mm ZANUSSI /
CABLE 1000mm
ZANUSSI
002544:
**ELECTROLUX
PROFESSIONAL
S.P.A.**



1128006 CAVO
CON SPINA STAMP.
SCHUKO 3X1 MT2 /
CABLE WITH PLUG
SCHUKO 3X1 MT2



1128007 CAVO
CON SPINA SCHUKO
3X1,5 - 2000mm /
CABLE WITH PLUG
SCHUKO 3X1,5 -
2000mm



1128023 CAVO
ELETTRICO
SILICONE D. 2,5mm /
SILICONE CABLE D.
2,5mm



4105036 UGELLO
TARGET B.E. GPL
0,14 /
NOZZLE TARGET
B.E. GPL 0,14
R7042014:
ILSA SPA
MA1888000:
MARENO
X30400: GIGA
059216:
ELECTROLUX
1888000:
SILKO ALI SPA
MA1888000:
OLIS DIVISIONE
MA1888000:
SILKO ALI SPA



4105024 UGELLO
TARGET NUOVO GPL
PIL. 01 0,19 /
NOZZLE NEW
TARGET GPL PIL.01
X30000:
GIGA GRANDI
CUCINE SRL
0977092: SIT
RTCP800041:
MBM- EUROTEC SRL
- DIV. COOKING
SERVICE



4105023 UGELLO
TARGET METANO
0,27 140 GAS
NATURALE /
METHANE TARGET
NOZZLE 0,27 140
MA1887800:
MARENO
INDUSTRIE ALI
SPA
BN6A013107:OLIS-
1887800:
SILKO ALI SPA
RTCP800059:
MBM- EUROTEC SRL
-



MA1887800: OLIS
MA1887800:
SILKO ALI SPA
67400000:
MODULAR SPA
0977113: SIT

4105018 UGELLO
TARGET NUOVO
METANO 0,36 /
NOZZLE NEW
TARGET MARSH
GAS 0,36
RTCP800040:
MBM- EUROTEC SRL
-
0977091: SIT



4105082 UGELLO
MARK 20 GPL PIL 160
/
PILOT BURNER
NOZZLE GPL MARK
20 SUITABLE FOR
SIT SERIES 160
0977156: SIT
1033719600:
SILKO ALI SPA
MA1033719600:OLI
S
MA1033719600:
SILKO ALI SPA
MA1033719600:
MARENO
INDUSTRIE



4105047 UGELLO
PIL. 0160 GPL (25) /
PILOT BURNER
NOZZLE 0160 GPL
(25)
0977123: SIT



4105026 UGELLO
PILOTA 0160 GPL D.
30 /
PILOT NOZZLE 0160
GPL D. 30
533020200:
LOTUS SPA
RTC900216:
MBM- EUROTEC SRL
- DIV. COOKING
SERVICE
RTC900216:
ELETTROBAR
0977122: SIT



4105025 UGELLO
PILOTA 0160
METANO D. 41 /
PILOT NOZZLE
0160GN D. 41
0977118: SIT
MA1033719700:
OLIS DIVISIONE
DI ALI GROUP SPA



-
MA1033719700:
SILKO ALI SPA
MA1033719700:
MARENO
INDUSTRIE
053670:
ELECTROLUX
PROFESSIONAL
S.P.A.

4105066 UGELLO
 PIL. 0160 GN 3 VIE
 0,51 /
 PILOT NOZZLE. 0160
 GN 3WAYS (51)
0977119: SIT



4105131 UGELLO
 PILOTA 0160 CITTA'
 (75) /
 PILOT NOZZLE 0160
 CITY (75)
MA1033719800:
MARENO
INDUSTRIE ALI
SPA
1033719800:
SILKO ALI SPA



4105033 ASS.
 UGELLO+PORTAUGE
 LLO D.0,20 PIL. 0100
 GPL /
 NOZZLE+NOZZLE-
 HOLDER D. 0,20 PIL.
 0100
0977030: SIT
MA1415100:
MARENO
INDUSTRIE ALI
SPA
7042005:
GIORIK SPA
MA1415100:
OLIS DIVISIONE
DI ALI GROUP SPA



-
MA1415100:
SILKO ALI SPA
R7042005: ILSA
SPA
8C0030:
EMMEPI GRANDI
CUCINE S.R.L.

4105035 ASS.
 UGELLO+PORTAUGE
 LLO D.0,25 PIL. 0100 /
 NOZZLE+NOZZLE-
 HOLDER D. 0,25 PIL.
 0100
0977051: SIT
MA1842300:
MARENO
INDUSTRIE ALI



SPA
MA1842300:
SILKO ALI SPA
103502100:
MARENO
INDUSTRIE ALI
SPA

4105032 ASS.
 UGELLO+PORTAUGE
 LLO D.0,30 PIL.0100 /
 NOZZLE+NOZZLE-
 HOLDER D. 0,30 PIL.
 0100
0977029: SIT



4105034 ASS.
 UGELLO+PORTAUGE
 LLO D.0,35 PIL. 0100
 METANO /
 NOZZLE+NOZZLE-
 HOLDER D. 0,35 PIL.
 0100
67205900:
MODULAR SPA
MA1422600:
MARENO
INDUSTRIE ALI
SPA
0108069:
SILKO ALI SPA
7042006:
GIORIK SPA
SIRO108069:
SILKO ALI SPA
0977031: SIT



4105109 ASS.UG+P
 ORTAUG.D.0,40 PIL.
 0100 /
 NOZZLE D.0,40 PIL.
 0100
12008938:
FAGOR
INDUSTRIALE
S.R.L.



4105046 UGELLO
 SPEC. 20 PIL 019 /
 SPEC. NOZZLE 20
 FOR PILOT 019



4105095 UGELLO
 SPEC. D. 0,30 PIL 0100
 - 190 /
 NOZZLE SPEC. D. 0,30
 PIL 0100 - 190
0977163: SIT



4105127 UGELLO
G.P.L. 16
(PIL.526F+470F) G16.2
/
NOZZLE G.P.L. 16
(PIL.526F +470 F)
G16.2
BN6A013240:
OLIS DIVISIONE
DI ALI GROUP SPA
-



4105096 UGELLO
PILOTA POLIDORO
GPL 20
NOZZLE POLIDORO
GPL 20
18100060:
ELFRAMO SPA
054286:
ELECTROLUX
PROFESSIONAL
S.P.A.



4105100 PILOT
BURNER NOZZLE
NATURAL GAS CODE
25 / 2 FORI /
PILOT BURNER
NOZZLE NATURAL
GAS CODE 25 / 2
HOLE



4105107 UGELLO
PER PILOTA 27-2 /
NOZZLE FOR PILOT
27-2



4105052 UGELLO
PILOTA METANO
(NR.40) /
PILOT BURNER
NOZZLE (NR.40)
NATURAL GAS



4105122 "UGELLO
PILOTA; DIA 0,45" /
"PILOT NOZZLE; DIA
0.45"
054038:
ELECTROLUX
PROFESSIONAL
S.P.A.
18100061:
ELFRAMO SPA



4105042 INIETTOR
E PILOTA D.021
G4SF7 METANO /
PILOT INJECTOR
D.021 G4SF7
G6057036: SIT
RTC700389: MBM



4105058 UGELLO
MONO D 0.35 CH.ES. /
NOZZLE MONO D
0:35 CH.ES.
RTC700647:
MBM- EUROTEC SRL
- DIV. COOKING
SERVICE



4105049 UGELLO
GPL PER PILOTA
4103066 /
NOZZLE GPL FOR
PILOT 4103066
MA933000:
MARENO
INDUSTRIE ALI
SPA



4105031 UGELLO
D.1,45 CREPIERES /
NOZZLE D.1,45 FOR
CREPIERES
PR3G051: FABA SRL



4105041 INIETTOR
E §0.20 /
INJECTOR NOZZLE
?0.20
33T0040:
ANGELO PO
GRANDI CUCINE
SPA



4117186 INIETTOR
E CAPSULA N*39
A.PO /
INJECTOR NOZZLE
N*39 A.PO
33T0240:
ANGELO PO
GRANDI CUCINE
SPA



4105001 GIGLEUR
RUBINETTO
ADDOLCITORE /
GIGLEUR FOR
WATER-SOFTNER
COCK
23210022:
RANCILIO SPA



4105044 INIETTOR
E BRUCIATORE CPLT
CB GRIGIA I /
BURNER INJECTOR
CB
GRIGLIA "I": CB
SRL



S&P Cooking Catalogue 2017

4105045 INIETTOR
E BRUCIATORE CPLT
CB GRIGIA BEX/MEX
/
BURNER INJECTOR
CB BEX/MEX
GRIGLIE BEX/MEX:
CB SRL



4105074 INIETTOR
E §0.85 /
NOZZLE §0.85
33T1550:
ANGELO PO
GRANDI CUCINE
SPA

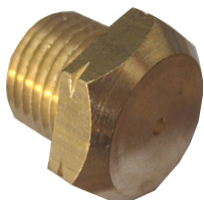

4105113 GIGLEUR
LIQUIGAS D. 90 /
GIGLEUR D.90
210015:
MAGISTER
SISTEMA CAFFE'
SRL



4105062 UGELLO
GAS; DIA 100 GPL 30-
37 MBAR /
NOZZLE GAS, LPG
??DIA 1 30-37 MBAR
270200910: GICO
SPA
33T1580:
ANGELO PO
GRANDI CUCINE
SPA
059342:
ELECTROLUX
PROFESSIONAL
S.P.A.



4105114 GIGLEUR
LIQUIGAS D. 100 /
GIGLEUR D. 100
210016:
MAGISTER
SISTEMA CAFFE'
SRL

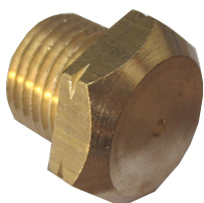

4105123 UG. L 105
G.P.L. BR "D" 70-90
CE /
GAS INJECTOR L 105
G.P.L. " D" BR 70-90
CE
BN2510368:
OLIS DIVISIONE
DI ALI GROUP SPA
-



4105063 UGELLO
D.110 /
NOZZLE
0A2076:
ELECTROLUX
PROFESSIONAL
S.P.A.
270202150: GICO
SPA



33T1600:
ANGELO PO
GRANDI CUCINE
SPA

4105138 INIETTOR
E G31 37 MBAR GF15-
15+15 110K /
INJECTOR G31 MBAR
GF 37 15-15 15 + 110K
RTC700033:
MBM- EUROTEC SRL
- DIV. COOKING
SERVICE

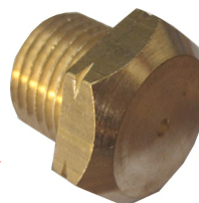

4105118 UGELLO
GAS M11x1 WS 13 /
GAS NOZZLE M11x1
WS 13
BN2510370:
OLIS DIVISIONE
DI ALI GROUP SPA
-



4105115 GIGLEUR
METANO D. 135 /
GIGLEUR D. 135
210017:
MAGISTER
SISTEMA CAFFE'
SRL

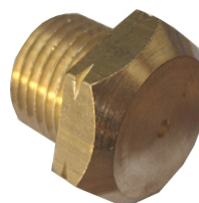

4105126 UGELLO
L.135 GPL /
NOZZLE 135 GPL
BN2510441:
OLIS DIVISIONE
DI ALI GROUP SPA
-

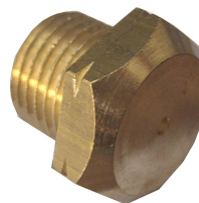

4105133 INIETTOR
E §1.50 /
INJECTOR §1.50
X34700:
GIGA GRANDI
CUCINE SRL
33T1680:
ANGELO PO
GRANDI CUCINE
SPA
0A2103:
ELECTROLUX
PROFESSIONAL
S.P.A.

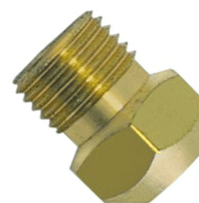

S&P Cooking Catalogue 2017

4105116 GIGLEUR
METANO D. 155 /
GIGLEUR D. 155
210018:
MAGISTER
SISTEMA CAFFE'
SRL

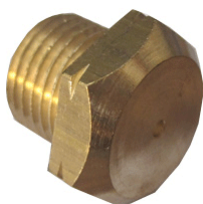

4105158 UGELLO
GAS BRUCIATORE
M10x1 ø 1.20 mm /
GAS JET M10x1 ø 1.20
mm
67400500:
MODULAR SPA



4105073 INIET.D.1.
602.50 K /
INJECTOR 1.602.50 K
RTC0700441:
MBM- EUROTEC SRL
- DIV. COOKING
SERVICE



4105112 UGELLO
PICCOLO D.136 EV.
(0272) /
SMALL NOZZLE D.
136 EV. (0272)
40413600:
BERTO'S SPA



4105151 INIETTOR
E §0.50 /
INJECTOR §0.50
3032930:
ANGELO PO
GRANDI CUCINE
SPA



4105147 "UGELLO
GAS; N°180; G.N." /
GAS JET M10x1 ø 1.90
mm
056793:
ELECTROLUX
PROFESSIONAL
S.P.A.



4105154 UGELLO
CORTO /75 M10x1 ø
0.75 mm /
GAS NOZZLE M10x1
ø 0.75 mm
MA520811:
MARENO
INDUSTRIE
520811:
SILKO ALI SPA



4105142 "UGELLO
GAS N°195; GAS
NATURALE" /
NOZZLE GAS N195;
NATURAL GAS "
OC0141:
ELECTROLUX
PROFESSIONAL
S.P.A.



4105130 UGELLO
GAS PICCOLO D.85 /
SMALL GAS
NOZZLE D.85
40408500:
BERTO'S SPA



4105146 "UGELLO;
N°220; GAS
NATURALE" / G
AS JET M10x1 ø 2.20
mm
0A2083:
ELECTROLUX
PROFESSIONAL
S.P.A.



4105140 UGELLO
GAS GPL
BRUCIATORE LOTUS
F2/13- 78G CH12X14.0
Ø110 /
NOZZLE GAS LPG
BURNER LOTUS F2 /
13- 78G CH12X14.0
Ø110
533043200:
LOTUS SPA



4105143 "UGELLO;
N°260; GAS
NATURALE; 20
MBAR" /
Nozzle; N 260;
NATURAL GAS; 20
MBAR
OC0144:
ELECTROLUX
PROFESSIONAL
S.P.A.



4105103 UGELLO
M 9X1 H14 120K /
NOZZLE M 9X1 H14
120K
7042798:
GIORIK SPA
R7042798: ILSA
SPA



4105069 UGELLO
GAS; DIA 1,05 /
GAS NOZZLE D. 1,05
050501:
ELECTROLUX
PROFESSIONAL
S.P.A.



S&P Cooking Catalogue 2017

4105155 UGELLO
N2 J.8710305026 /
NOZZLE FOR PILOT
BURNER LPG
50mBAR

MA932900:

MARENO
INDUSTRIE ALI
SPA

MA932900:

SILKO ALI SPA



4105157 UGELLO
GAS BRUCIATORE
D.190 /
NOZZLE GAS
BURNER D.190

67407900:

MODULAR SPA



4105160 GIGLEUR
ALIMENTAZIONE
GRUPPO F=0,57 /
JET GROUP F=0,57

00276:

LA SPAZIALE SPA



4105144 "UGELLO
GAS; DIA 2-25" /
"NOZZLE GAS; DIA 2-
25"

056471:

ELECTROLUX
PROFESSIONAL
S.P.A.



4105128 UGELLO
BRUCIATORE GW12
D= 95 G30/31 50 /
BURNER NOZZLE
GW12 D = 95 G30/31
50

18110105:

ELFRAMO SPA



4105141 "UGELLO;
DIAMETRO 2,85" /
"NOZZLE DIAMETER
2.85"

0C0551:

ELECTROLUX
PROFESSIONAL
S.P.A.



4105117 UGELLO
LUNGO D125 /
GAS INJECTOR BORE
D. 125 FOR GAS
RANGE

67406600:

MODULAR SPA



4105156 UGELLO
BRUCIATORE D=120
M10X1 /
GAS NOZZLE M10x1
ø 1,20 mm

18110111:

ELFRAMO SPA



4105168 UGELLO
LUNGO DM.140 /
NOZZLE DM.140

290201430: GICO

SPA



4105153 UGELLO
BRUCIATORE D=185
M10X1 /
GAS NOZZLE M10x1
ø 1.85 mm

18110110:

ELFRAMO SPA



4105159 UGELLO
LUNGO D.145 /
NOZZLE GAS
BURNER D.145

67407000:

MODULAR SPA



4105110 GIGLEUR
GRUPPO SAN
MARCO /
NOZZLE SAN
MARCO



4105104 UGELLO
M9 X 1 H18,5 175L /
NOZZLE M9 X 1 H18,5
175L

R7042715: ILSA

SPA

7042715: GIORIK

SPA



4105139 UGELLO
GAS METANO
CUOCIPASTA
BERTO'S /
NOZZLE NATURAL
GAS PASTA COOKER
BERTO'S

40222500:

BERTO'S SPA



4105097 UGELLO
D.0,21 (NO.29) LPG
30MBAR /
PILOT BURNER
NOZZLE D.0,21
(NO.29) LPG 30MBAR



MBM- EUROTEC SRL
- DIV. COOKING
SERVICE
31273600:
BERTO'S SPA

4130011 RUBINETT
O GAS 20S S/PILOTA
3/8 /
GAS TAP 20S
WITHOUT PILOT 3/8

1341700:
MARENO
INDUSTRIE ALI SPA
054628-054109-0A:
ELECTROLUX
PROFESSIONAL
S.P.A.
1000X10100:
GIGA GRANDI
CUCINE SRL
100370:
SILKO ALI SPA
7060013:
GIORIK SPA

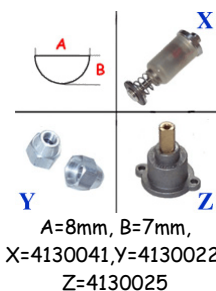
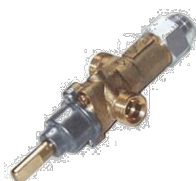

4130045 VALVOLA
COMPLETA GYROS
CB /
GYROS COMPLETE
GAS COCK CB
GYROS: CB SRL



4130048 RUBINETT
O GAS FUTURMAT /
GAS COCK
FUTURMAT



4130008 RUBINETT
O SICUREZZA 052145 /
COCK 052145
052145:
ELECTROLUX
PROFESSIONAL
S.P.A.

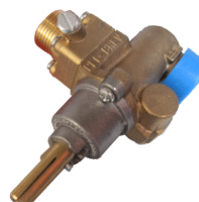

4130012 RUBINETT
O GAS 21S C/PILOTA
3/8 /
GAS TAP 21S WITH
PILOT 3/8

MA1888700:
MARENO
MA1031500200:
MARENO
531108900:
LOTUS SPA
531042900:
LOTUS SPA
531032100:
LOTUS SPA
531025500:
LOTUS SPA
5018905405:
AMBACH
22272500-3127370:
BERTO'S SPA
0000X10500: **GIGA**
100731:
SILKO ALI SPA
MA1031500200:
SILKO ALI SPA
MA1888700:
SILKO ALI SPA
SIRO100731:
SILKO ALI SPA
RTCU700259: **MBM**
CO3139: **FIMAR**
S.P.A.
31273700: **BERTO'S**
SPA
1888900: **MARENO**
167996:

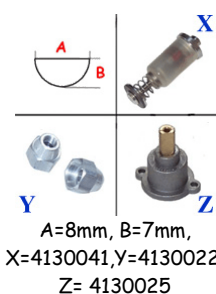

4127135 RUBINETT
O DI SICUREZZA 3/8"-
3/8" / "TAP 3/8""-3/8""
0420025: **SIT**



4130059 "RUBINETT
O GAS VALVOLATO;
21S" /
GAS TAP 21S
OC2025:
ELECTROLUX
PROFESSIONAL
S.P.A.



4130068 U912109000
GRIFO 18700 BY-PASS
1,15 /
U912109000 18700 GAS
VALVE BY-PASS 1.15
12003726:
FAGOR
INDUSTRIALE S.R.L.



4130053 RUBINETT
O GAS /
GAS TAP
69000251:
RANCILIO SPA



S&P Cooking Catalogue 2017

4130013 RUBINETT
O GAS 22S VALV.
FL.VERT. 10x1 /
VALVED GAS TAP 22S
VERTICAL FLANGE

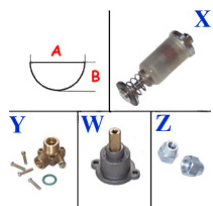

A=10mm, B=8mm,
X=4130042, Y=4130028
W=4130026
Z=4130024

0000X10900:
GIGA GRANDI
CUCINE SRL
MA1888600:
MARENO
INDUSTRIE

O100732:
SILKO ALI SPA
MA1888600:
SILKO ALI SPA
BN6A011500:
SILKO ALI SPA
SIR0100732:
SILKO ALI SPA
512250003:
EMMEPI GRANDI
CUCINE S.R.L.

4130014 RUBINETT
O GAS 22S
VALV.FL.VERT. 9X1 /
VALVED GAS TAP 22S
VERTICAL FLANGE
9X1

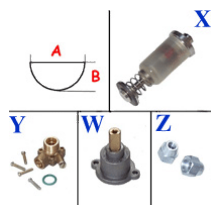

A=10mm, B=8mm,
X= 4130042, Y=
4130028, W= 4130026,
Z= 4130023

MA1031027900:
MARENO
INDUSTRIE ALI SPA
160344:
MBM- EUROTEC SRL
- DIV. COOKING
SERVICE
O100733:
SILKO ALI SPA
168001:
MBM- EUROTEC SRL

4130017 RUBINETT
O GAS 23S
VALV.FL.ORIZ. 9X1 /
VALVED GAS COCK
23S HORIZONTAL
FLANGE 9X1
168007:

MBM- EUROTEC SRL
- DIV. COOKING
SERVICE
30100003:

OFFCAR THE GREAT
COOKING S.R.L.
RTC800019:
MBM- EUROTEC SRL
- DIV. COOKING
SERVICE

BN6A013600:
OLIS DIVISIONE DI
ALI GROUP SPA -
054811:
ELECTROLUX
PROFESSIONAL
S.P.A.

100736:
SILKO ALI SPA
SIR0100736:
SILKO ALI SPA

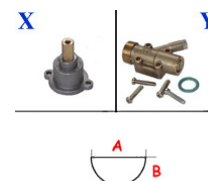
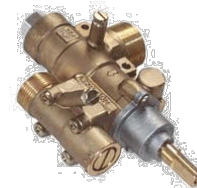

A=10mm, B=8mm,
X=4130027, Y=4130031

4130015 RUBINETT
O GAS 22S
VALV.FL.ORIZ. 8X1 /
VALVED GAS COCK
22S HORIZONTAL
FLANGE 8X1

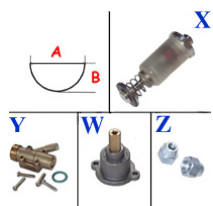
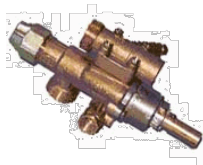

A=10mm, B=8mm,
X=4130042, Y=4130029
W=4130026,
Z=4130022

4130016 RUBINETT
O GAS 22S
VALV.FL.ORIZ. 9X1 /
VALVED GAS COCK
22S HORIZONTAL
FLANGE 9X1

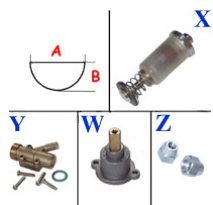
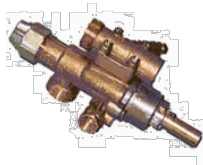

A=10mm, B=8mm,
X=4130042, Y=4130029
W=4130026,
Z=4130023

100372:
SILKO ALI SPA
168000:
MBM- EUROTEC SRL
RTC900011:
MBM- EUROTEC SRL
- DIV. COOKING
SERVICE
1337200-18886600:
MARENO
INDUSTRIE
BN6A011500:
OLIS DIVISIONE DI
ALI GROUP SPA -
5018909180:
AMBACH
808196:
EMMEPI GRANDI
CUCINE S.R.L.

4130018 RUBINETT
O GAS 23S
VALV.FL.VERT. 9X1 /
VALVED GAS TAP 23S
VERTICAL FLANGE
9X1

12009525:
FAGOR
INDUSTRIALE S.R.L.
MA1345300:
MARENO
INDUSTRIE ALI SPA
MA1954600:
MARENO
INDUSTRIE ALI SPA
O100734:

SILKO ALI SPA
SIR0100734:
SILKO ALI SPA

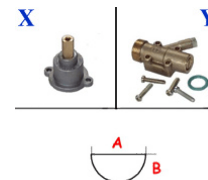
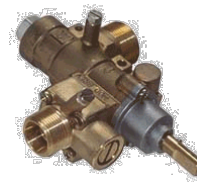

A=10mm, B=8mm,
X=4130027, Y=4130030

4130051 RUBINETT
O GAS
TERMOSTATICO
PEL24ST 55-110°C 9X1 /
THERMOSTATED GAS
TAP PEL24ST 55-110°C
9X1

435218: GICO SPA
78CBG:
OLIS DIVISIONE DI
ALI GROUP SPA -
RTBF800033:
MBM- EUROTEC SRL
- DIV. COOKING
SERVICE

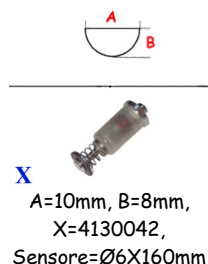

4130019 RUBINETT
O GAS
TERM.PEL24STS 120-
320° /
THERMOSTATED GAS
TAP PEL24STS 120°-
320°

160225:
MBM- EUROTEC SRL
- DIV. COOKING
SERVICE
168003:
MBM- EUROTEC SRL
- DIV. COOKING
SERVICE

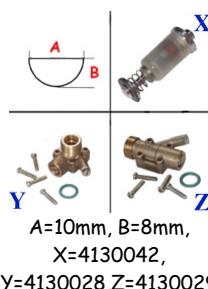
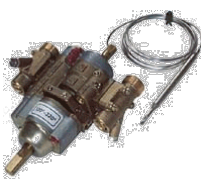

4130033 RUBINETT
O PEL 24ST ATT.FISSI
TC.9X1 120°-320° /
COCK PEL 24ST FIXED
CONNECTIONS TC 9X1
120°-320°

BN6A023700:
OLIS DIVISIONE DI
ALI GROUP SPA -
33A1790: ANGELO
PO
5018908975:
AMBACH
0100724:
SILKO ALI SPA
0000X11200:
GIGA GRANDI
CUCINE SRL
33A2840: ANGELO PO
SIRO100724:
SILKO ALI SPA
RTC800011:
MBM- EUROTEC SRL

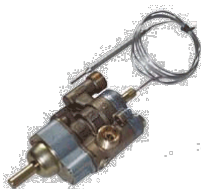

4130038 RUBINETT
O GAS TERM.PEL25ST
ORIZZ.30-90° /
VALVED GAS TAP
PEL25ST
HORIZONTAL
FLANGE 30-90°

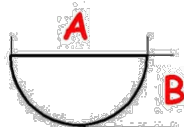

4130020 RUBINETT
O GAS TERM.PEL25ST
OR.150-300 /
HORIZONTAL
THERMOSTATED GAS
TAP PEL25ST 150°-300°

167998:
MBM- EUROTEC SRL
- DIV. COOKING
SERVICE
K22131: A.T.A. SRL
RTC700289:
MBM- EUROTEC SRL
- DIV. COOKING
SERVICE

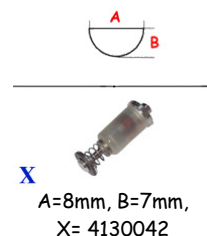

22274600:
BERTO'S SPA
22274500:
BERTO'S SPA
168005:
MBM- EUROTEC SRL
- DIV. COOKING
SERVICE
435223: GICO SPA

4130021 RUBINETT
O GAS TERM.PEL25ST
V.150-300 /
VERTICAL
THERMOSTATED GAS
TAP PEL25ST 150°-300°

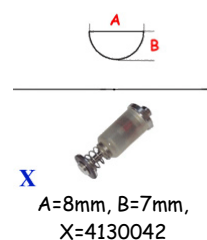
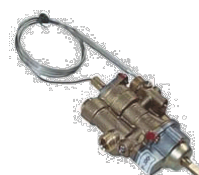

4130037 KIT
SOSTITUZ.EGA-
PINTOSI FORNO /
GAS THERMOSTAT
CONVERSION KIT FOR
OVEN
OC0006:
ELECTROLUX
PROFESSIONAL
S.P.A.



4130034 RUBINETT
O GAS
TERMOSTATATO
CREPIERES /
THERMOSTATED GAS
COCK FOR CREPIERES
PR3G044: FABBA SRL

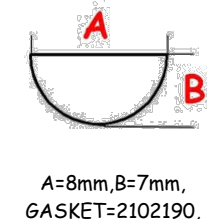
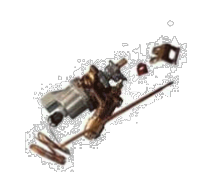

4130063 CAVALLOT
TO DIAMETRO 21MM
PER 21/S /
GAS TAP STIRRUP D.
21mm FOR 21/S



4130064 CAVALLOT
TO DIAMETRO 21 PER
22/S /
GAS TAP STIRRUP D.
21mm FOR 22/S



4130065 CAVALLOT
TO DIAMETRO 27 PER
21/S /
GAS TAP STIRRUP D.
27mm FOR 21/S



4130066 CAVALLOT
TO DIAMETRO 27MM
PER 22/S /
GAS TAP STIRRUP D.
27mm FOR 22/S



4130022 DADO
TERMOCOPPIA 8X1
RUBINETTO PEL /
THERMOCOUPLE NUT
8X1 FOR TAPS PEL
PINTOSSI

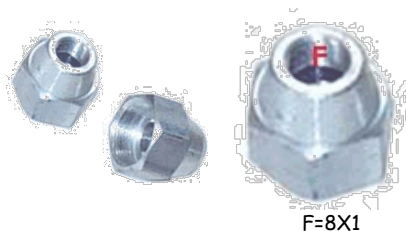

4130023 DADO
TERMOCOPPIA 9X1
RUBINETTO PEL /
THERMOCOUPLE NUT
9X1 FOR TAPS PEL
PINTOSSI

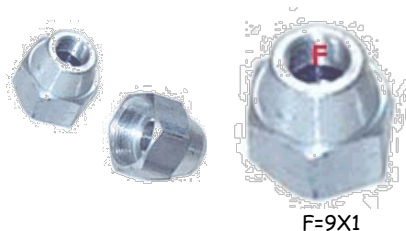

4130024 DADO
TERMOCOPPIA 10X1
RUBINETTO PEL /
THERMOCOUPLE NUT
10X1 FOR TAPS PEL
PINTOSSI

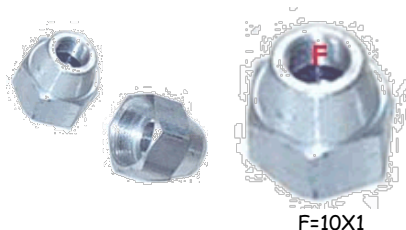

4130025 CAPPUCCI
O RUBINETTO PEL
MOD. 20/21 /
CAP FOR TAPS PEL
PINTOSSI MOD. 20/21

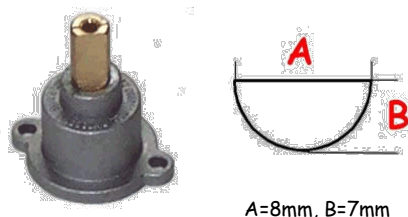

4130026 CAPPUCCI
O RUBINETTO PEL
MOD. 22 /
CAP FOR TAPS PEL
PINTOSSI MOD. 22

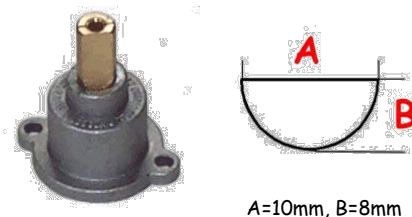

4130027 CAPPUCCI
O RUBINETTO PEL
MOD. 23 /
CAP FOR TAPS PEL
PINTOSSI MOD. 23

059853:
ELECTROLUX
PROFESSIONAL
S.P.A.

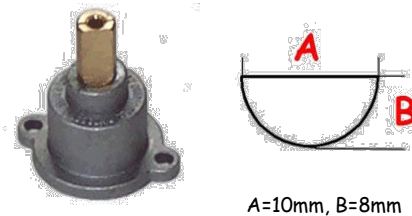

4130028 ASS.BASET
TA V.VITI GUAR.
PEL22S /
VERTICAL KIT
SCREWS GASKETS
PEL22S

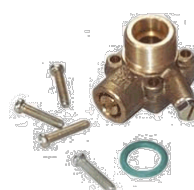

4130029 ASS.BASET
TA OR.VITI GUAR. 22S
/
HORIZONTAL KIT
SCREWS GASKETS
PEL22S

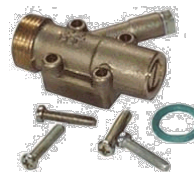

4130030 ASS.BASET
TA V.VITI GUAR.
PEL23 /
VERTICAL KIT
SCREWS GASKETS
PEL23S

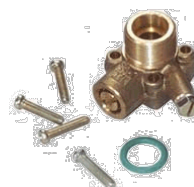

4130031 ASS.BASET
TA OR.VITI GUAR.
PEL23 /
HORIZONTAL KIT
SCREWS GASKETS
PEL23S

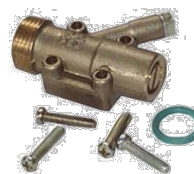

4130041 MAGNETE
PER 20/21S /
MAGNET FOR 20/21S

0100752:
SILKO ALI SPA
SIR0100752:
SILKO ALI SPA



4130042 MAGNETE
PER 22S/24/25 /
MAGNET FOR
22S/24/25



Ø = 13,60 mm

3108076 MANOPO
LA RUBINETTO GAS
D. 6X5 /
GAS COCK HANDLE
D. 6X5
30654700:
BERTO'S SPA



A= 6mm, B= 5mm

4130071 BYPASS
D.45 PER PEL 21S /
BYPASS COCK FOR
PEL 21S D.55
22783500:
BERTO'S SPA



3108009 MANOPO
LA RUBINETTO GAS
D. 8 /
GAS COCK WHEEL
D.8
31875900:
BERTO'S SPA
22650900:
BERTO'S SPA



A= 8mm, B=6mm

4130070 BYPASS
RUBINETTO D.55 PER
PEL 21S /
BYPASS COCK FOR
PEL 21S D.55
22783600:
BERTO'S SPA



3108008 MANOPO
LA RUBINETTO GAS
D. 10/
GAS COCK WHEEL
D.10



A= 10mm, B= 8mm

4130069 BY-PASS
RUB.21S D.080 0981/22
/
BY-PASS NOZZLE FOR
GAS VALVE 21S D.080
0981/22
RTCU700271:
MBM- EUROTEC SRL
- DIV. COOKING
SERVICE



3108031 FASCETT
A MANOPOLA 70 X
RUB. GAS /
GAS COCK HANDLE
CLAMP D. 70



3108029 FASCETT
A MANOPOLA
C/PIEZO 70 X RUB.
GAS /
GAS COCK HANDLE
CLAMP D. 70



3108089 MANOPO
LA 30/90° /
HANDLE 30/90°
903982: SILANOS
SRL

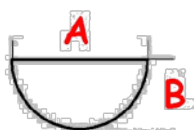

A= 6mm, B= 5mm

3108091 MANOPO
LA TERMOSTATO
40/210° /
THERMOSTAT
HANDLE 40/210°



A= 6mm, B= 5mm

3108090 MANOPO
LA TERMOSTATO
50/300° /
THERMOSTAT
HANDLE 50/300°



A= 6mm, B= 5mm

3108529 SERIGRAF
IA MANOPOLA /
SCREEN PRINTING
KNOB
31952200:
BERTO'S SPA



3108534 ANELLO
MANOPOLA VERDE
PER RUBINETTO
G2S9 (NUOVO) /
RING KNOB GREEN
FOR COCK G2S9
(NEW)
164581:
MBM- EUROTEC
SRL - DIV.
COOKING SERVICE

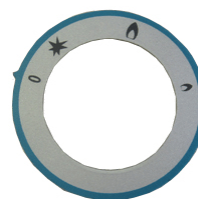

S&P Cooking Catalogue 2017

3108227 ANELLO
MANOPOLA
RUBINETTO V.G4S7 /
RING KNOB TAP
V.G4S7

RTC700308EX:

MBM- EUROTEC

SRL - DIV.

COOKING SERVICE

RTC700309:

MBM- EUROTEC

SRL - DIV.

COOKING SERVICE

168345:

MBM- EUROTEC

SRL - DIV.

COOKING SERVICE



3108526 MANOPO
LA ROSSA
VERNICIATA 8X6,5 /
KNOB RED PAINTED
8X6,5

35878100:

BERTO'S SPA

35877100:

BERTO'S SPA



3108538 MANOPO
LA VERNICIATA PER
PERNO 8X6,5 /
PAINTED KNOB
STUD 8X6,5

35876100:

BERTO'S SPA



3108030 FASCETT
A MANOPOLA 70 X
THERMOSTATO /
THERMOSTAT
HANDLE CLAMP D.
70

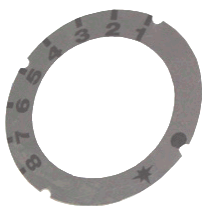

3108539 SERIGRAF
IA MANOPOLA
FORNO GAS /
SCREEN PRINTING
KNOB GAS OVEN

31952400:

BERTO'S SPA



3108530 SERIGRAF
IA MANOPOLA 8
POSIZIONI + PILOTA
/
SCREEN PRINTING
KNOB (8 POSITIONS)
+ PILOT

31952300:

BERTO'S SPA



3108485 ANELLO
MANOP.COM.P.E.E29
Q HOBART NEW /
RING KNOB COM.P-E
E23Q HOBART NEW

169363:

MBM- EUROTEC

SRL - DIV.

COOKING SERVICE

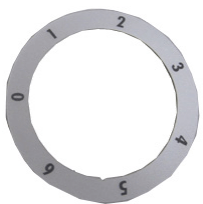

3108462 MANOPO
LA ROSSA P 6x4.6 A
0° RAL3000 /
RED KNOB P 6X4.6 A
0° RAL3000

35877200:

BERTO'S SPA



3108587 MANOPO
LA COMMUTATORE
D40mm 5X6mm /
KNOB D40mm
5X6mm

*: BERTO'S SPA

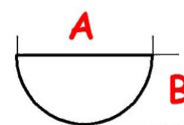
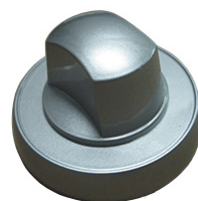

A=6mm , B=5mm,
DIAMETER 40mm

3108527 SOTTOMA
NOPOLA ROSSA /
RED UNDER KNOB

35954800ex:

BERTO'S SPA

35954900:

BERTO'S SPA



3108253 MANOP.T
ERM.GBM47 TURCH.

/
GAS THERMOSTAT
KNOB D. 70mm

RTC700344:

MBM- EUROTEC

SRL -

168861:

MBM- EUROTEC

SRL -

168867:

MBM- EUROTEC

SRL - DIV.

COOKING SERVICE

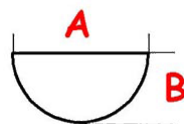

A= 8 mm, B= 7 mm

3108522 *FP*
ASSIEME
MANOPOLA GAS GR.
CON PILOTA GICO /
ASSEMBLY KNOB
GAS GICO WITH
PILOT

790119450: GICO

SPA

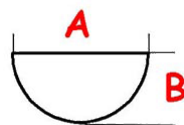

A= 10 mm, B= 8 mm

S&P Cooking Catalogue 2017

3108230 MANOPO
LA BRUCIATORE
GICO /
BURNER KNOB GICO
790119460EX:
GICO SPA
766100010: GICO
SPA

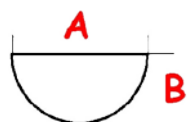

A = 8 mm, B = 6 mm

3108365 ASSIEME
MANOPOLA
INTERRUTTORE /
SWITCH KNOB
790119500: GICO
SPA

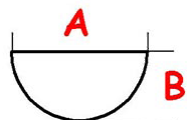

A = 6 mm, B = 5 mm

3108279 MANOPO
LA CUOCIPASTA
ELETTRICI GICO /
KNOB 4-TACTS
260mm
790106910EX:
GICO SPA
790119510EX:
GICO SPA
766100050: GICO
SPA

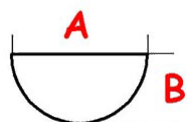
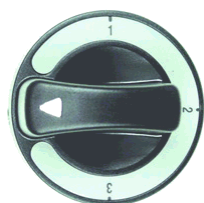

A = 6,5 mm, B = 5 mm

3108569 MANOPO
LA ELETTRICA
THERMOSTATO 100-
180° GICO /
KNOB THERMOSTAT
100-180 ° ELECTRIC
GICO
790119560EX:
GICO SPA
766100120: GICO
SPA

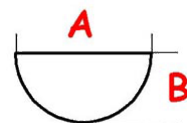

A = 6mm, B = 5mm

3108603 ASSIEME
MANOPOLA
RUBINETTO GAS
THERMOSTATO
STYLE /
GAS HANDLE
770124970: GICO
SPA

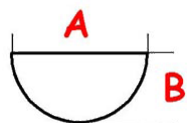
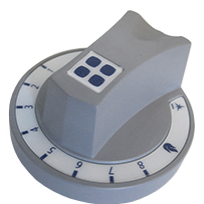

A=8mm, B=6mm

3108444 MANOP.C
OM.EBM47 0+1
TURCH. /
KNOB COMPLETE
FOR EBM47 0+1
RTC700421:
MBM- EUROTEC
SRL - DIV.
COOKING SERVICE
168878:
MBM- EUROTEC
SRL - DIV.
COOKING SERVICE

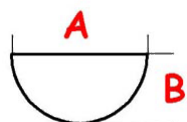

A=6mm, B=5mm

3108364 MANOP.C
OM.P.E.E47 0+6
TURCH. /
KNOB E47 0+6
RTC700403:
MBM- EUROTEC
SRL - DIV.
COOKING SERVICE
168878:
MBM- EUROTEC
SRL - DIV.
COOKING SERVICE



3108334 MANOP.T
ERM.EF47 TURCH. /
THERMOSTAT KNOB
EF47
RTC700594:
MBM- EUROTEC
SRL - DIV.
COOKING SERVICE
168878:
MBM- EUROTEC
SRL - DIV.
COOKING SERVICE



3108051 MANOPO
LA MBM RUB. GAS
8/10 /
GAS COCK HANDLE
8/10 MBM
RTC800018:
MBM- EUROTEC
SRL - DIV.
COOKING SERVICE
168874:
MBM- EUROTEC
SRL - DIV.
COOKING SERVICE



A = 10mm, B = 8mm

3108159 MANOPO
LA P/GPL 90 /
KNOB GPL90
RTC800014:
MBM- EUROTEC
SRL - DIV.
COOKING SERVICE

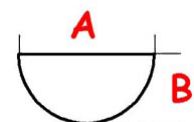

A=10mm, B=8mm

3108556 MANOPO
LA FUOCHI OFFCAR
/
KNOB FIRES
OFFCAR
401101EX:
OFFCAR THE
GREAT COOKING
S.R.L.
401405:
OFFCAR THE
GREAT COOKING
S.R.L.

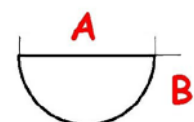

A=10mm, B=8mm

S&P Cooking Catalogue 2017

3108292 MANOPO
LA FRYTOP A GAS
OFFCAR /
KNOB FOR GAS
FRYTOP OFFCAR
401415:
OFFCAR THE
GREAT COOKING
S.R.L.

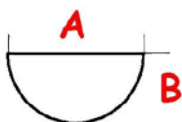

A=8mm, B=6mm

3108331 MANOPO
LA 100-180°C
D.76MM /
KNOB 100-180°C D.
76MM
BN2994380:
OLIS DIVISIONE
DI ALI GROUP SPA



A= 10 mm, B= 6 mm

3108575 KIT
MANOPOLA 1-6 +
MOLLA /
GREY KNOB ø 77 mm
1-6
BN2994360:
OLIS DIVISIONE
DI ALI GROUP SPA

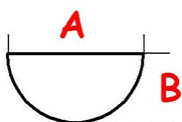

A= 8 mm, B= 6,5 mm

3108399 MANOPO
LA EL. PERNO §6 FR
E/MEC /
KNOB
3015831:
ANGELO PO
GRANDI CUCINE
SPA



A= 10 mm, B= 6 mm

3108390 MANOPO
LA FR GAS CHIGLIA
COMPL. /
KNOB
3134730:
ANGELO PO
GRANDI CUCINE
SPA



3108570 MANOPO
LA GAS PERNO §8
FA /
KNOB GAS - PIVOT
D. 8
3013171:
ANGELO PO
GRANDI CUCINE
SPA

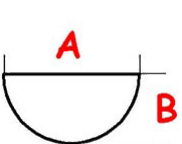

A= 8mm, B= 6mm

3108557 MANOPO
LA ELETTRICA
PERNO §6 /
KNOB ELECTRICAL
PIN §6
3015941:
ANGELO PO
GRANDI CUCINE
SPA

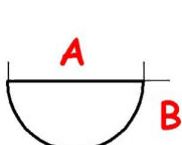

A= 6 mm, B= 5 mm

3108273 GR.MANO
POLA GAS S23 §10 /
GAS KNOB S23 §10
6300523:
ANGELO PO
GRANDI CUCINE
SPA



3108461 MANOPO
LA ELETTRICA A.PO
/
KNOB ELECTRICAL
A.PO
6300482:
ANGELO PO
GRANDI CUCINE
SPA

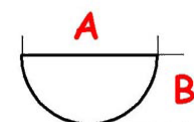

3108094 MANOPO
LA GAS 6300489 A.
PO /
GAS KNOB 6300489
A. PO
6300489:
ANGELO PO
GRANDI CUCINE
SPA

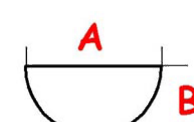
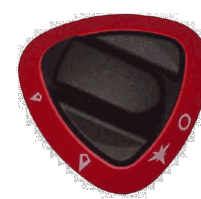

3108178 GR.MANO
POLA EL 481 A.PO /
KNOB 481 A. PO'
6300481:
ANGELO PO
GRANDI CUCINE
SPA

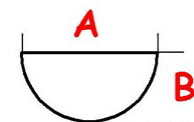

3108173 MANOPO
LA EL 484 A.PO' /
KNOB 484 A. PO'
6300484:
ANGELO PO
GRANDI CUCINE
SPA

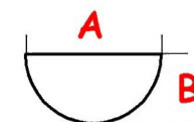

3108171 MANOPO
LA GAS A.PO' /
GAS KNOB A. PO'
6300487:
ANGELO PO
GRANDI CUCINE
SPA

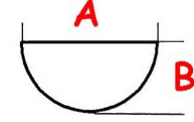

A= 8 mm, B= 6,5 mm

3108191 GRUPPO
MANOPOLA GAS
A.PO /
GAS KNOB A. PO'
6300510:
ANGELO PO
GRANDI CUCINE
SPA

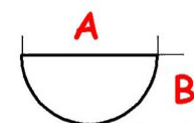

A= 8 mm, B= 7 mm

S&P Cooking Catalogue 2017

3108192 MANOPO
LA FRY TOPO
ALPHA-DELTA A.PO
/

KNOB FRY TOPO
ALPHA-DELTA A.
PO'
6300503:
ANGELO PO
GRANDI CUCINE
SPA

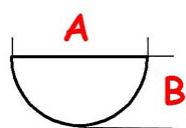

A= 10 mm, B= 8 mm

3108172 MANOPO
LA EL. 483 A.PO' /
KNOB 483 A.PO'

6300483:
ANGELO PO
GRANDI CUCINE
SPA

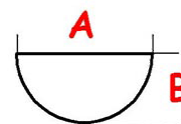

3108174 MANOPO
LA EL. 492 A.PO' /
KNOB 492 A.PO'

6300492:
ANGELO PO
GRANDI CUCINE
SPA

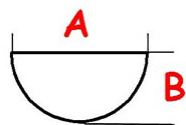

A= 10 mm, B= 6 mm

3108601 GRUPPO
MANOPOLA GAS /
GAS HANDLE

6300553:
ANGELO PO
GRANDI CUCINE
SPA

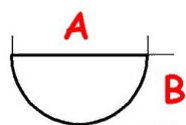

A=8mm,B=6mm

3108175 MANOPO
LA GAS 486 A.PO' /
GAS KNOB 486 A. PO'

6300486:
ANGELO PO
GRANDI CUCINE
SPA

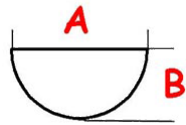

A= 8 mm, B= 7 mm

3108177 GR.MANO
POLA EL. 480 A.PO' /
KNOB 480 A.PO'

6300480:
ANGELO PO
GRANDI CUCINE
SPA

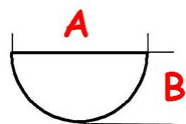

A= 10 mm, B= 6 mm

3108179 GR.
MANOPOLA EL.491
A.PO' /
KNOB 491 A.PO'

6300491:
ANGELO PO
GRANDI CUCINE
SPA

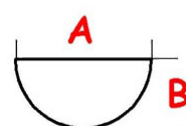

3108180 GR.
MANOPOLA EL.493
A.PO' /
KNOB 493 A.PO'

6300493:
ANGELO PO
GRANDI CUCINE
SPA

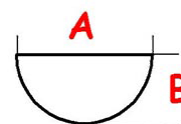

3108176 MANOPO
LA EL. A.PO' /
KNOB A.PO'

36M4560:
ANGELO PO
GRANDI CUCINE
SPA

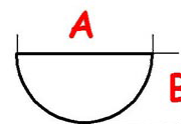

3108451 MANOPO
LA ELETTRICA /
KNOB ELECTRIC

36M2400:
ANGELO PO
GRANDI CUCINE
SPA

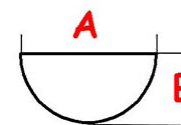

A= 10 mm, B= 6 mm

3108202 MANOPO
LA GAS A.PO' /
GAS KNOB A.PO

36M2390:
ANGELO PO
GRANDI CUCINE
SPA

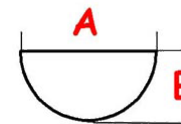

A= 10 mm, B=8mm

3108203 IMPUGNA
TURA FISSA A.PO
8x6,5 /
KNOB A.PO

36M3050:
ANGELO PO
GRANDI CUCINE
SPA

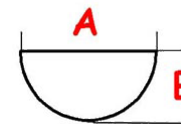

A= 8 mm, B= 6,5 mm

3108048 MANOPO
LA PIANO COTTURA
058534 /
KNOB GAS TAP
58534

058534:
ELECTROLUX
PROFESSIONAL
S.P.A.

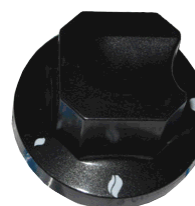

3108277 MANOPO
LA /
KNOB

058597:
ELECTROLUX
PROFESSIONAL
S.P.A.

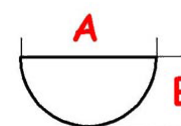

A= 10 mm, B= 8 mm

S&P Cooking Catalogue 2017

3108285 MANOPO
LA GAS /
GAS KNOB
059206:
ELECTROLUX
PROFESSIONAL
S.P.A.

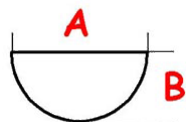

A= 8 mm, B= 6,5 mm

3108415 "MANOPO
LA: S90" /
KNOB "S90"
0G5268:
ELECTROLUX
PROFESSIONAL
S.P.A.



3108577 MANOPO
LA ø 60 mm 110-190°C
/
KNOB BLACK ø 60
mm 110-190°C
006570:
ELECTROLUX
PROFESSIONAL
S.P.A.



3108416 MANOPO
LA /
KNOB
0G3409:
ELECTROLUX
PROFESSIONAL
S.P.A.



3108545 MANOPO
LA /
KNOB
004658:
ELECTROLUX
PROFESSIONAL
S.P.A.



3108547 MANOPO
LA x4146077 /
KNOB x4146077
0C5256:
ELECTROLUX
PROFESSIONAL
S.P.A.

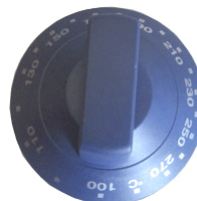

3108033 MANOPO
LA X RUB. GAS
059244 /
GAS COCK HANDLE
059244
059244:
ELECTROLUX
PROFESSIONAL
S.P.A.



3108270 MANOPO
LA 185°C (140-185°C)
Ø76MM MAX /
KNOB 185°C (140-
185°C) Ø76MM MAX
2008672: GIORIK
SPA

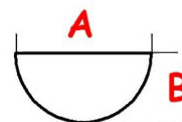

A= 10 mm, B= 6 mm

3108254 MANOPO
LA 059248 /
KNOB 059248
059248:
ELECTROLUX
PROFESSIONAL
S.P.A.



3108468 MANOPO
LA CUOCIPASTA
GAS D.10 / GAS
KNOB D.10
R62302: ILSA SPA

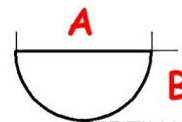

A= 10 mm, B= 8 mm

3108553 MANOPO
LA /
KNOB
004356:
ELECTROLUX
PROFESSIONAL
S.P.A.



3108450 MANOPO
LA CUCINA DESCO /
KNOB FOR DESCO
STOVE
62300000: ILSA
SPA
R62300: ILSA SPA

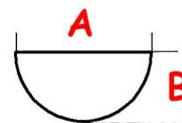

A= 8 mm, B= 6,5 mm

3108046 MANOPO
LA X RUBINETTO
0A2460 /
KNOB FOR TAP
0A2460
0A2460:
ELECTROLUX
PROFESSIONAL
S.P.A.



3108550 MANOPO
LA FRIGGITRICE
GAS 900+EL. (Ø6) /
KNOB GAS FRYER
900 + EL. (Ø6)
R60805EX: ILSA
SPA
R62305: ILSA SPA



3108442 MANOPO
LA /
KNOB
R69030170:
LAINOX ALI SPA
LAR69030170:
LAINOX ALI SPA



3108295 MANOPO
LA ACQUA FREDDA
/
COLD WATER KNOB
MACM143100:
MARENO
INDUSTRIE ALI
SPA

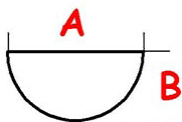

A=10mm, B=8mm

3108605 MANOPO
LA ACQUA CALDA /
HOT WATER KNOB
MACM143200:
MARENO
INDUSTRIE ALI
SPA

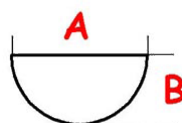

A=10mm, B=8mm

3108252 MANOPO
LA RUBINETTO GAS
MOZZO /
GAS COCK KNOB
MACM061700:
MARENO
INDUSTRIE ALI
SPA

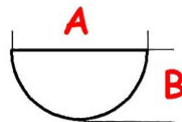

A= 8 mm, B= 6 mm

3108294 MANOPO
LA TERMOSTATO
50-300°C /
THERMOSTAT KNOB
50-300°C
MACM059800:
MARENO
INDUSTRIE ALI
SPA



3108354 MANOPO
LA CUCINE GAS 700 /
KNOB FOR GAS
KITCHEN 700
MA1840900:
MARENO
INDUSTRIE ALI
SPA

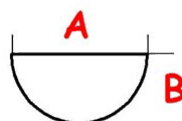

A= 6 mm, B= 5 mm

3108533 CORPO
MANOPOLA
+MOLLETTA
.R.V.G4S9/1 /
BODY HANDLE
WITH SPRING.
R.V.G4S9 / 1
168848:
MBM- EUROTEC
SRL - DIV.
COOKING SERVICE

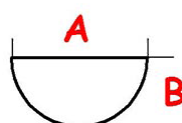

A= 10 mm, B= 8 mm

165927EX:
MBM- EUROTEC
SRL - DIV.
COOKING SERVICE

3108484 CORPO
MANOP.COMM.E4F6
H NERA+MOLLETTA
/ BLACK KNOB FOR
COMMUTATOR
E4F6H
169340:
MBM- EUROTEC
SRL - DIV.
COOKING SERVICE

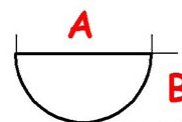

A= 6 mm, B= 5 mm

3108299 MANOPO
LA "S" GAS Ø 10 / "
KNOB ""S"" GAS ?
10"
0101787:
SILKO ALI SPA
SIR0101787:
SILKO ALI SPA

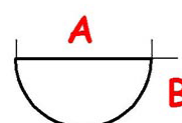

A= 10 mm, B= 8 mm

3108291 MANOPO
LA S GAS Ø 8 /
KNOB ? 8
0101786:
SILKO ALI SPA
SIR0101786:
SILKO ALI SPA

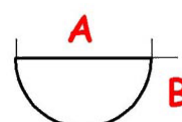

A= 8 mm, B= 6 mm

3108500 "MANOPO
LA ""S"" POS.0-6" /
"KNOB" "S" "POS.0-6"
0101790:
SILKO ALI SPA
SIR0101790:
SILKO ALI SPA



3108242 MANOPO
LA TERMOSTATO
FORNO CB /
OVEN THERMOSTAT
KNOB CB
PIZZA CB: CB SRL



3108306 MANOPO
LA /
KNOB
0A2995:
ELECTROLUX
PROFESSIONAL
S.P.A.



S&P Cooking Catalogue 2017

3108307 MANOPO
LA / KNOB
0A5267:
ELECTROLUX
PROFESSIONAL
S.P.A.



3108280 MANOPO
LA SP4-C4ELETTORI
/ SWITCH KNOB
7915: A.T.A. SRL

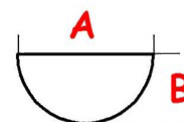

A= 5 mm, B= 5 mm

3108269 MANOPO
LA / KNOB
050341:
ELECTROLUX
PROFESSIONAL
S.P.A.

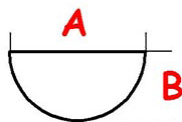

A= 9 mm, B= 6 mm

3108251 MANOPO
LA BIANCA /
WHITE KNOB
5813: A.T.A. SRL



3108268 MANOPO
LA / KNOB
051552:
ELECTROLUX
PROFESSIONAL
S.P.A.

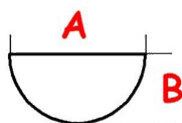

A= 9,5 mm, B= 6 mm

3108297 MANOPO
LA GRIGIA
TAMPOGRAFATA /
GREY KNOB
6826: A.T.A. SRL



PERNO QUADRO /
SQUARED PIN
A= 5 mm , B= 5 mm

3108357 MANOPO
LA / KNOB
052087:
ELECTROLUX
PROFESSIONAL
S.P.A.



3108528 MANOPO
LA PA66 180° PERNO
8X6,5 /
KNOB STUD 180 8X6,
5 - PA66
38877100:
BERTO'S SPA



3108281 MANOPO
LA / KNOB
0A2954:
ELECTROLUX
PROFESSIONAL
S.P.A.



3108236 MANOPO
LA INTERRUPTORE
ROTATIVO PERNO
QUADRO /
SWITCH KNOB HF 32
CB
GIRRAROSTI
PLANTERI
ELETTRICI: CB SRL
MANOPOLA INT
ROT:
MAZZER LUIGI SPA

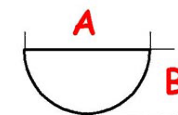

A= 5 mm, B= 5 mm

3108309 MANOPO
LA / KNOB
047859:
ELECTROLUX
PROFESSIONAL
S.P.A.



3108243 MANOPO
LA REGOLATORE
ENERGIA /
ENERGY CONTROL
KNOB
HOT DOG- SW1-
WUSTERL A RULLI-
GOLOSO: CB SRL
10010042: CB SRL



3108096 MANOPO
LA TERMOSTATO
VETRINA FABA /
WARM SHOW CASES
THERMOSTAT KNOB
30/90?
PRFO021: FABA SRL



A= 6mm, B= 5mm

3108239 MANOPO
LA RUBINETTO
VALVOLATO GYROS
CB /
GYROS COCK KNOB
CB
GYROS: CB SRL

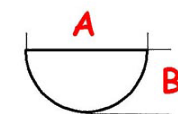

A= 8 mm , B= 6,5 mm

3108237 MANOPO
LA ESPOSITORI /
KNOB
GV-ECV/SELF: CB
SRL



*: MBM- EUROTEC
SRL - DIV.
COOKING SERVICE
*: MBM- EUROTEC
SRL - DIV.
COOKING SERVICE
161796:

ELETTROBAR
DIVISIONE DELLA
EUROTEC SRL

3108053 MANOPO
LA BICOLORE
COMENDA /
CONTROL KNOB
TWO COLOURS B-
BT-F
B, BT, F:
COMENDA ALI SPA



PERNO QUADRO /
SQUARED PIN
A= 5 mm , B= 5 mm

3108351 MANOPO
LA TERMOSTATO
D=55 GWT /
THERMOSTAT KNOB
D=55 GWT
00038683:
ELFRAMO SPA

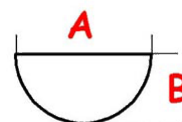

A= 8 mm, B= 6 mm

3108220 MANOPO
LA CON INDICE
GR.CHIARO /
KNOB FOR BC-BR-
C95-C155
450323:
COMENDA ALI SPA



PERNO QUADRO /
SQUARED PIN
A= 5 mm , B= 5 mm

3108215 MANOPO
LA TERMOSTATO
D=55 /
THERMOSTAT KNOB
D=55
00033250:
ELFRAMO SPA

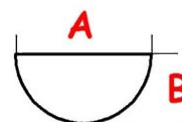

A= 8 mm, B= 6 mm

3108024 MANOPO
LA ZANUSSI 048340 /
KNOB ZANUSSI
048340
048340:
ELECTROLUX
PROFESSIONAL
S.P.A.



3108216 MANOPO
LA INTERRUPTORE
D=55 /
SWITCH KNOB D=55
00006500:
ELFRAMO SPA

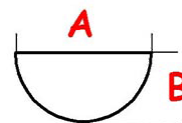

A= 8 mm, B= 6,5 mm

3108578 "MANOPO
LA CON
ADATTATORE;
DIA.6; KIT" /
KNOB WITH
ADAPTER; DIA.6;
KIT"
0C6670EX:
ELECTROLUX
PROFESSIONAL
S.P.A.
0C8700:
ELECTROLUX
PROFESSIONAL
S.P.A.

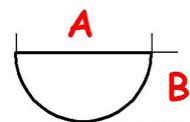
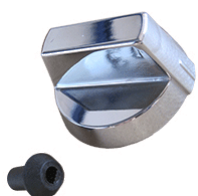

ADATTATORE
A= 10mm, B= 8mm,
A= 6mm, B=5mm

3108235 MANOPO
LA X TIMER TS
BIFRESATO /
TIMER KNOB TS
PR40054: FABBA SRL
PR40016: FABBA SRL

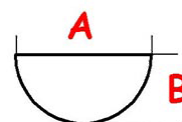

A= 7 mm, B= 5 mm

3108504 GRUPPO
MANOPOLA INTERR.
22 /
GROUP KNOB
SWITCH 22
999106:
ELETTROBAR
DIVISIONE DELLA
EUROTEC SRL



3108396 MANOPO
LA TIMER
TOSTIERA/FORNO /
TIMER KNOB FOR
TOASTER/OVEN

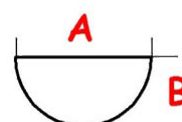

A= 6 mm, B= 5 mm

3108310 MANOPO
LA TERMOSTATO /
THERMOSTAT
KNOB
164649:
ELETTROBAR
DIVISIONE DELLA
EUROTEC SRL



3108541 MANOPO
LA /
KNOB
MAN038:
GARBIN
INDUSTRIES SRL



S&P Cooking Catalogue 2017

3108056 MANOPO
LA COMANDO /
CONTROL HANDLE
*****;
RANCILIO SPA
PR10008: **FABA SRL**

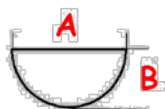

A= 6mm, B= 5mm

3108263 MANOPO
LA TIMER MAZZER /
TIMER KNOB
MAZZER
S000MAB01QQQ:
MAZZER LUIGI SPA

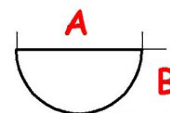

A= 4 mm, B= 4 mm

3108114 MANOPO
LA COMANDO /
CONTROL KNOB
PR3G048: **FABA SRL**

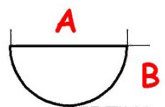

A= 8 mm , B= 6,5 mm

3108524 MANOPO
LA COMPLETA
DRIVE SERIE FCB
RAL7021 /
COMPLETE KNOB
DRIVE (FCB SERIES
RAL7021
170886:



**MBM- EUROTEC
SRL - DIV.
COOKING SERVICE**

3108282 MANOPO
LA TERMOSTATO
DX - MARRONE /
RIGHT
THERMOSTAT KNOB
26669+25828:
**HOONVED - ALI
SPA**
25098EX:
**HOONVED - ALI
SPA**



3108440 MANOPO
LA
COMMUTAT.EH009+
EH030 /
COMMUTATOR
KNOB EH009+EH030
AC06200EX:
OEM ALI SPA
AC00600:
OEM ALI SPA

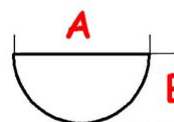

A=6mm,B=5mm

3108455 MANOPO
LA ELETT. L900-L700
/ KNOB L900-L700
R803150: ILSA SPA



3108383 MANOPO
LA GRIGIA OLIS
D.40MM /
KNOB OLIS D.40MM
BN3199020:
**OLIS DIVISIONE
DI ALI GROUP SPA**
-

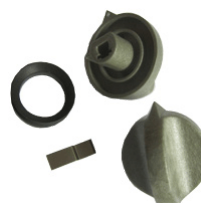

3108543 MANOPO
LA NERA ø 50 mm /
KNOB BLACK ø 50
mm
MANI0021:
DR. ZANOLLI S.R.L.
R863151: ILSA SPA

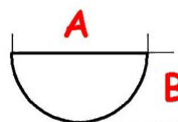
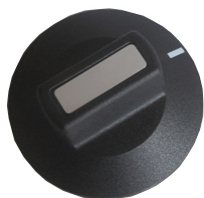

A= 6 mm,B= 5 mm

3108010 MANOPO
LA
PROGRAMMATORE
IME /
PROGRAMMER
HANDLE IME
CEMTR:
OMNIWASH SRL

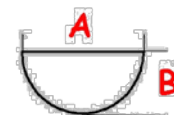

A= 6mm, B= 5mm

3108266 MANOPO
LA NERA (INDICE
SERIGR. -DA C.L.) /
BLACK KNOB
6446600: LASA SRL



3108018 MANOPO
LA COMMUTATORE
COMPLETA /
COMPLETE SWITCH
HANDLE
10705215:
RANCILIO SPA
45107000:
MODULAR SPA



A= 6mm, B= 5mm

3108166 MANOPO
LA 750023 /
KNOB 750023
1036705300:
MARENO
**INDUSTRIE ALI
SPA**
6446560: LASA SRL
260007: LASA SRL



3108558 MANOPO
LA COMMUTATORE
FORNETTO /
BLACK KNOB ø 44
mm -D shaft hole 6x4.6
mm
903940:
SILANOS SRL

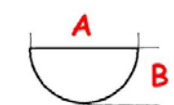
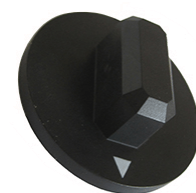

A=6mm, B=5mm

3108347 MANOPO
LA VARIATORE R5
PLUS /
KNOB R5 PLUS



3108311 MANOPO
LA D=52 VALV GAS
GM/D
/ GAS VALVE KNOB
D=52 GM/D



00035813:
ELFRAMO SPA
00035809:
ELFRAMO SPA

3108584 MANOPO
LA T.N. 0-1-2 PM.IE /
KNOB T.N. 0-1-2
PM.IE

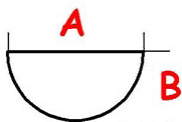

A=6mm, B=5mm,
TOP=3108585,

3108116 PROLUNG
A MANOPOLA SIT
L57 /
KNOB EXTENSION
SIT L57
0999957: SIT



3108583 MANOPO
LA T.N. 30-100°C
PM.IE. /
KNOB T.N. 30-100 ° C
PM.IE

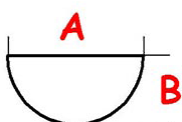

A=6mm, B=5mm

3108271 *BASETT
A MANIGLIA
FCV.TURCHESE /
BASE HANDLE
FCV.TURCHE
RTFOC00401:
MBM- EUROTEC
SRL - DIV.
COOKING SERVICE
170831:
MBM- EUROTEC
SRL - DIV.
COOKING SERVICE



3108336 MANOPO
LA TIMER
MACINADOSATORE
SERIGRAFATA 6' /
TIMER KNOB

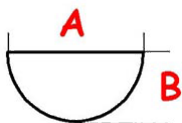

A= 5 mm, B= 3,5 mm

3108298 ADATTAT
ORE MANOPOLA
EUROSIT /
KNOB ADAPTER
EUROSIT
0997209: SIT



3108233 MANOPO
LA 8X6.5+3.4 PRF.
20.3 /
KNOB 8X6.5+3.4 PRF.
20.3

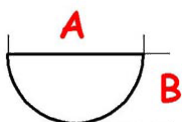

A= 8 mm, B= 6,5 mm

3108579 ADATTAT
ORE PER
MANOPOLA /
KNOB ADAPTER
0C7345:
ELECTROLUX
PROFESSIONAL
S.P.A.



ESTERNO:
A= 10mm, B= 8mm,
ADATTATORE
INTERNO
A= 6mm, B= 5mm

3108001 MANOPO
LA MINISIT
C/REGOLAZIONE /
MINISIT HANDLE
WITH ADJUSTMENT



0100856:
SILKO ALI SPA
SIRO100856:
SILKO ALI SPA
835721:
OFFCAR THE
GREAT COOKING
S.R.L.

3108552 PROLUNG
A /
EXTENSION
0C8571:
ELECTROLUX
PROFESSIONAL
S.P.A.



3108194 MANOPO
LA TIMER
ELTTROBAR
COMPLETA /
COMPLETE TIMER
KNOB ELTTROBAR



S&P Cooking Catalogue 2017

3108195 MANOPO
LA TIMER
ELETTOBAR /
TIMER KNOB
ELETTOBAR
447089:
ELETTOBAR
DIVISIONE DELLA
EUROTEC SRL

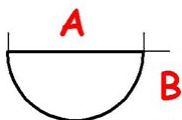

A= 7 mm, B= 6 mm

3108196 PULSANT
E START /
START PUSH-
BUTTON
226051:
ELETTOBAR
DIVISIONE DELLA
EUROTEC SRL



3108060 MANOPO
LA TIMER
REGOLABILE /
ADJUSTABLE TIMER
KNOB
25095:
HOONVED - ALI
SPA



3108551 GHIERA
MANOPOLA
COTTURA 2008 /
DIAL KNOB
COOKING 2008
R60609: ILSA SPA



3108238 MANIGLI
A COMPLETA CB /
COMPLETE HANDLE
CB
6V-ECV/SELF: CB
SRL
10010009EX: CB
SRL



3108596 MANIGLI
A FILTRO VASCA
180843 /
HANDLE FILTER
TANK 180843
170827:
COMENDA ALI SPA



H=33mm, L=225mm

3108231 MANIGLI
A U918 B mm.64 ORO
LUCIDO /
HANDLE U918 B
mm.64
PRF0053: FABIA SRL



3108204 MANOPO
LA TOSTIERA FABIA /
TOASTER HANDLE
FABIA
PR40023: FABIA SRL



3108476 MANOPO
LA SPINGICARR. AD
"U" int. fori 115 /
"U" SHAPED
HANDLE INT. 115



Interasse=115mm

3108257 MANIGLI
A FRIGO NERA AD
INCASTRO
FIOCCHETTI
74311008 /
HANDLE FOR
REFRIGERATOR



3108241 MANIGLI
A PORTA CB /
DOOR HANDLE CB
01220104: CB SRL

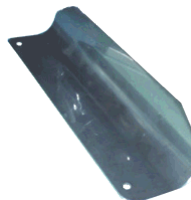

3108501 MANIGLI
A A.NSA47 INOX 304
DIAMOND /
HANDLE
STAINLESS STEEL
DIAMOND 304
168204:
MBM- EUROTEC
SRL - DIV.
COOKING SERVICE
PACU800122EX:
MBM- EUROTEC
SRL - DIV.
COOKING SERVICE



3108274 MANIGLI
A F.G4SF
SMALT.NERA /
BLACK HANDLE
F.G4SF
PACU800131ex:
MBM- EUROTEC
SRL - DIV.
COOKING SERVICE
168205:
MBM- EUROTEC
SRL - DIV.
COOKING SERVICE



S&P Cooking Catalogue 2017

3108275 MANIGLI
A F.G6SF2
SMALT.NERA /
BLACK HANDLE
F.G6SF2
PACU800060:
MBM- EUROTEC
SRL - DIV.
COOKING SERVICE



3108561 BORCHIA
CON FILETTO 26x19
PER RUBINETTO DI
ARRESTO ECO /
STUD WITH THREAD
26x19 TO STOP COCK
ECO



KNOB=3108560

3108181 MANOPO
LA ANELLO ROSSO
A.PO /
RED RING KNOB A.
PO'
36M2640:
ANGELO PO
GRANDI CUCINE
SPA



3108256 MANOPO
LA /
KNOB WATER
025260:
ELECTROLUX
PROFESSIONAL
S.P.A.
054254:
ELECTROLUX
PROFESSIONAL
S.P.A.



3108184 MANOPO
LA ANELLO BLU 030
A.PO /
BLUE RING KNOB
030 A. PO'
36M4030:
ANGELO PO
GRANDI CUCINE
SPA



3108355 MANOPO
LA RUBINETTO
CARICO ACQUA
CUOCIPASTA
/ COCK KNOB
833463:
OFFCAR THE
GREAT COOKING
S.R.L.



3108471 MANOPO
LA RUBINETTO
ACQUA ROSSO /
KNOB HOT WATER
3162200:
ANGELO PO
GRANDI CUCINE
SPA



3108023 MANIGLI
A PORTA FORNO
A.PO 36M6380 /
OVEN DOOR
HANDLE A.PO
36M6380
36M6380:
ANGELO PO
GRANDI CUCINE
SPA



A=10mm, B= 8mm

3108472 MANOPO
LA RUBINETTO
ACQUA BLU /
KNOB COLD WATER
3162210:
ANGELO PO
GRANDI CUCINE
SPA



3108330 MANIGLI
A /
HANDLE
0F0029:
ELECTROLUX
PROFESSIONAL
S.P.A.



3108512 MANIGLI
A ATERMICA PER
ACQUA FREDDA /
ATHERMIC HANDLE
FOR COLD WATER

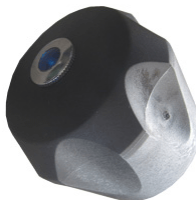

3108366 MANIGLI
A /
HANDLE
0E1155:
ELECTROLUX
PROFESSIONAL
S.P.A.

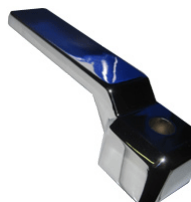

3108560 MANIGLI
A FULVIA
COMPLETA IN
OTTONE CROMATO
ACQUA FREDDA /
HANDLE FULVIA
FULL BRASS
CHROME COLD
WATER



STUD=3108561

3108600 "MANIGLI
A PORTA; KIT; FCF6;
GAS/ELT." /
DOOR HANDLE KIT ;
FCF6 GAS/ELT
0C9988:
ELECTROLUX
PROFESSIONAL
S.P.A.



SUPPORTO/SUPPORT
L=500mm,
GUARNIZIONE/
GASKET L=1500mm

3108430 MANIGLI
A NERA RUBINETTO
CUOCI PASTA /
BLACK HANDLE
TAP PASTA COOKER

808432:

EMMEPI GRANDI
CUCINE S.R.L.

2001250: GIORIK
SPA

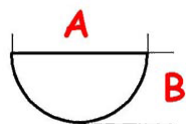

A= 9 mm, B= 7,5 mm

3108296 MANIGLI
A PER PORTA
FORNO COMPLETA
MODULAR /
HANDLE FOR OVEN
DOOR MODULAR

2013218:

MODULAR SPA

2012263:

MODULAR SPA

2013218: GIORIK

SPA



3108589 KIT
CHIUSURA /
COMPLETE DOOR
HANDLE FOR OVEN

LAR69010250ex:

LAINOX ALI SPA

LAR69010440:

LAINOX ALI SPA

LAR69010250:

OLIS DIVISIONE
DI ALI GROUP SPA

-



3108610 MANIGLI
A FORNO COVEN /
COVEN HANDLE
OVEN



3108424 IMPUGNA
TURA COMPLETA
MANIGLIA /
COMPLETE HANDLE

R11100300:

LAINOX ALI SPA

LAR11100300:

OLIS DIVISIONE
DI ALI GROUP SPA

-

LAR11100300:

LAINOX ALI SPA



SPRING=1117250

3108607 MANIGLI
A FORNO COVEN /
COVEN OVEN
HANDLE



3108555 MANIGLI
A PORTA /
DOOR HANDLE



3108261 MANOPO
LA NERA
INTERRUTTORE
125A /
SWITCH KNOB 125A

0301084: LAMBER

SRL



3108511 MANIGLI
A FORNO COVEN /
COMPLETE OVEN
DOOR HANDLE



A=8mm, B=8mm

3108244 MANIGLI
A F.FCV. TURCHESE
/
HANDLE FCV

160912ex:

MBM- EUROTEC

SRL - DIV.

COOKING SERVICE

RTFOC00360ex:

MBM- EUROTEC

SRL - DIV.

COOKING SERVICE

RIC0004434:

MBM- EUROTEC

SRL - DIV.

COOKING SERVICE

RTFOC0007:

MBM- EUROTEC

SRL - DIV.

COOKING SERVICE



3108185 VOLANTI
NO A.PO /
HAND-WHEEL A. PO'

36M4910:

ANGELO PO

GRANDI CUCINE

SPA



3108187 VOLANTI
NO D.200 A.PO /
HAND-WHEEL D.200
A. PO'

36M5562:

ANGELO PO

GRANDI CUCINE

SPA

C00248:

EMMEPI GRANDI

CUCINE S.R.L.



3108465 IMPUGNATURA ANATOMICA PER RUBINETTO DI SCARICO DA 3/4" E 1" / HANDLE FOR DRAIN TAP 3/4" AND 1"



3108240 MANOPO LA FERMAMOTORE CPL / STOP-MOTOR KNOB CPL
GYROS GAS: CB SRL



3108572 MANOPO LA FERMACARRELLO NOAW 350IQ 041399V2 ANNO 2004 / KNOB FOR CARRIAGE NOAW 350IQ 041399V2 YEAR 2004



3108420 MANOPO LA FERMACARRELLO B10MA / KNOB FOR CARRIAGE B10MA



3108421 MANOPO LA FERMACARRELLO B12MA / KNOB FOR CARRIAGE B12MA



3108573 MANOPO LA M10 art.70017 / KNOB M10
10374:
BREMA ICE
MAKERS SPA



TAP=3108574

3108374 MANOPO LA RUBINETTO CUOCIPASTA / TAP KNOB
760308790: GICO
SPA



3108598 KNOB, LOCKING TOP COVER / KNOB, LOCKING TOP COVER
915167: HOBART
GmbH

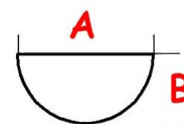

A=6mm, B=5mm

3108403 MANOPO LA DI REGOLAZIONE MAZZER / REGULATION KNOB -MAZZER-
S000MAB02AQQ:
MAZZER LUIGI SPA



3108499 MANOPO LA M8(FISS.TELAIO)BM 2 / KNOB M8 BM2
AC05400:
OEM ALI SPA



3108562 VOLANT. PORTA FS.2000 CR.(QAT43 / HANDWHEEL DOOR FS.2000 CR. (QAT43
QST0320:
OEM ALI SPA



3108360 MANOPO LA FISSAGGIO FILTRO FIL. M5 / FILTER FIXING KNOB M5
4159:
UNIVER-BAR SRL



3108341 MANOPO LA Ø 40 MM. PASSO M6 / KNOB ? 40 MM. M6



3108387 MANOPO LA / KNOB
082916:
ELECTROLUX
PROFESSIONAL
S.P.A.



3108323 POMOLO
SUL PRESSAMERCE
TUV /
KNOB
GL275: **FABA SRL**



3108564 MANOPO
LA OGIVALE PER
GRIGLIA
MAXIGRILL /
KNOB FOR GRID
MAXIGRILL
PR4G009: **FABA SRL**



3108563 IMPUGNA
TURA ART I 135/120-
11 /
HANDLE 135 / 120-11
33311203011:
GICO SPA



3108456 MANICO
PER CESTELLO
CUOCIPASTA /
HANDLE BASKET
PASTA COOKER
R61361: **ILSA SPA**



3108477 MANOPO
LA PER FORNO
TP.N.MC/29X115 /
OVEN DOOR
HANDLE Ø 30x110
mm M7x1
AC06600:
OEM ALI SPA



Ø=7mm

3108491 IMPUGNA
TURA B8MA /
KNOB B8MA



3108549 IMPUGNA
TURA B 10 MA /
HANDLE B 10 MA



3108422 IMPUGN
ATURA CON DISCO
B10MA /
HANDLE WITH DISC
B10MA



3108304 IMPUGNA
TURA CON DISCO
P.6 MA /
HANDLE P.6 MA



3108542 POMELO
D.45X87
ANODIZZATO NERO
OPACO ALL 6026 /
KNOB D.45X87
ANODIZED BLACK
TO 6026



disk 53MM = 4118278,
disk 58MM = 4118277

3108326 MANOPO
LA REGOLAZIONE /
ADJUSTING KNOB
41279:
**DITTING
MASCHINEN AG**



3108593 MANOPO
LA REGOLAZIONE
SPESSORE FETTA /
SLICE THICKNESS
CONTROL KNOB
033579:
**ELECTROLUX
PROFESSIONAL
S.P.A.**



Ø=12mm

3108591 MANOPO
LA OROLOGIO P. Ø
18 L. 73 mm. /
SLICE THICKNESS
CONTROL KNOB
D.18 L.73mm



3108581 MANOPO
LA AD OROLOGIO
X CELME
MOD.350/370 PERNO
Ø 14 mm. /
KNOB TO WATCH X
Celme MOD.350 / 370
PIN Ø 14 mm.



BUSH=3108582

3108582 BOCCOLA
PER MANOPOLA
OROLOGIO /
BUSH FOR 3108581



3108459 MANOPO
LA OROLOGIO P. 12
L. 52 /
KNOB SLICE
THICKNESS
CONTROL P.12
L.52mm



3108312 POMELLO
ALBERO
AFFETTATRICE
MARWEL D.18 /
SLICER KNOB
MARWEL D. 18



3108391 MANOPO
LA OROLOGIO P. 12
L. 83 /
KNOB P. 12 L.83



3108479 MANOPO
LA OROLOGIO P. 14
L. 120 /
KNOB SLICE
THICKNESS
CONTROL P.14
L.120mm



3108518 MANOPO
LA PRIMA
OBERWERK /
KNOB FIRST MODEL
Oberwerk



3108525 MANOPO
LA OROLOGIO
OMAS P. Ø18 L.65
mm. /
KNOB SLICE
THICKNESS
CONTROL OMAS P.
Ø18 mm L.65.



3108201 INSERTO
MANOPOLA A.PO /
KNOB PART A.PO
36M2800:
ANGELO PO
GRANDI CUCINE
SPA



3108506 CORPO
MANOPOLA EL. /
KNOB BODY
ELECTRIC
36M2620:
ANGELO PO
GRANDI CUCINE
SPA



3108356 PLACCA
BIANCA MANOPOLA
RUBINETTO DI
CARICO /
WHITE COVER FOR
COCK KNOB



833467:
OFFCAR THE
GREAT COOKING
S.R.L.

3108475 IMPUGNA
TURA SCARICO
CUOIPASTA /
HANDLE FOR DRAIN
TAP



MACM155200:
MARENO
MACM155200:
SILKO ALI SPA

3108352 MANIGLIA
A /
HANDLE
053760:
ELECTROLUX
PROFESSIONAL
S.P.A.



3108498 TV98
LEVA PRESSORE
BRILLANT. /
TV98 LEVER
PRESSURE
35NAA79227:
OEM ALI SPA



4146009 VALVOLA
MINISIT 40-110°C /
MINISIT VALVE 40-
110°C
0710819: SIT
0710817: SIT

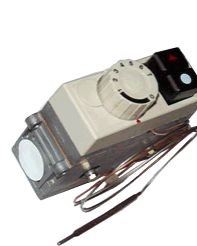

Z
X=3108001,Y=4146008
, Z= 1129042,
SENSORE=Ø5X122mm

4146004 VALVOLA
MINISIT FRIGGITRICE
110-190° C/RP /
FRYER VALVE 110-
190° C/RP
MA1393300:
MARENO
0710757: SIT
058496:
ELECTROLUX
1393300:
SILKO ALI SPA
7020210: GIORIK
MA1393300:
SILKO ALI SPA
MA1451024R:



Z
X=3108001,Y=4146008
, Z= 1129033,
SENSORE=Ø6X107mm

4146005 VALVOLA
MINISIT 50-190° S/RP
B5X95 /
MINISIT VALVE 50-
190° S/RP B5X95
GRCU900012:
MBM- EUROTEC SRL
- DIV. COOKING
SERVICE
1744300-1743324-:

MARENO
INDUSTRIE ALI SPA
5310027005:
LOTUS SPA
054267:
ELECTROLUX
PROFESSIONAL
S.P.A.
0108030:
SILKO ALI SPA
32271600:
BERTO'S SPA
7020200:
GIORIK SPA
SIR0108030:
SILKO ALI SPA
052267:
ELECTROLUX
PROFESSIONAL
S.P.A.



Z
X=3108001,Y=4146008
, Z= 1129001,
SENSORE=Ø 5X95mm

RTCU700642:
MBM- EUROTEC SRL
- DIV. COOKING
SERVICE
003655:
ELECTROLUX
PROFESSIONAL
S.P.A.
167549:
MBM- EUROTEC SRL
- DIV. COOKING
SERVICE

4146072 MINISIT
110-190 /
MINISIT VALVE 110-
190
0710764: SIT



Z
X=3108001,Y=4146008
, Z=1129033,
SENSORE=Ø6X102mm

4146010 VALVOLA
MINISIT 110-190°
FRIGGITRICE BULBO
C/ANELLO /
MINISIT VALVE FOR
FRYER BULB WITH
RING
145000:
SILKO ALI SPA
0003230:
ELFRAMO SPA
00032390:
ELFRAMO SPA



Z
X=3108001,Y=4146008
, Z= 1129002,
SENSORE=Ø 6X95mm

4146087 MINISIT 70
- 210 /
MINISIT VALVE 70 -
210



SENSORE=Ø
4X125mm

4146020 VALVOLA
MINISIT 50-190° FG RP
BULBO BOTTONE /
MINISIT VALVE FG
BUTTON BULB
0710752: SIT
5018907490:AMBAC
H



Z
X=3108001,Y=4146008
, Z=1129024,
SENSORE=, A=25mm,
Ø=13X14mm

4146011 VALVOLA
MINISIT 110-190 S/RP /
MINISIT VALVE 110-
190 S/RP
RTCU700574:
MBM- EUROTEC SRL
- DIV. COOKING
SERVICE
0710756: SIT
1743300-1393200:
MARENO
INDUSTRIE ALI SPA
531002700:
LOTUS SPA
BN9000150:
OLIS DIVISIONE DI
ALI GROUP SPA -
*: ELECTROLUX
PROFESSIONAL
S.P.A.
00038639:
ELFRAMO SPA



Z
X=3108001,Y=4146008
, Z= 1129033,
SENSORE=Ø6X102mm

4146043 VALVOLA
MINISIT FG 110-190 /
MINISIT VALVE FG
110-190
67102500:
MODULAR SPA
0710760: SIT
67102600:
MODULAR SPA



Z
X=3108001,Y=4146008
, Z=1129024,
SENSORE=, A=25mm,
Ø=13X26mm

4146073 MINISIT 70
- 310 S/RP /
MINISIT VALVE 70 -
310 S/RP
0710647: SIT



Z
X=3108001,Y=4146008
, Z=1129022,
SENSORE=Ø 4X73mm

4146003 VALVOLA
MINISIT 100-340 B5/70

/
MINISIT VALVE 100-
340 B5/70

GRCU900014:

MBM- EUROTEC SRL
- DIV. COOKING

SERVICE

MA1393100:

MARENO

INDUSTRIE ALI SPA

5310026005:

LOTUS SPA

RTC900064:

MBM- EUROTEC SRL
- DIV. COOKING

SERVICE

BN6A011701:

OLIS DIVISIONE DI
ALI GROUP SPA -

052068:

ELECTROLUX

056833*:

ELECTROLUX
PROFESSIONAL
S.P.A.

BR670/70,

BR690/80,

BR690/120:

MODULAR SPA

GRCU900015:

MBM- EUROTEC SRL
- DIV. COOKING

SERVICE

056883:

ELECTROLUX



X=3108001,Y=4146008
, Z=1129146,
SENSORE=Ø 5X62mm

4146079 VALVOLA
MINISIT MANUALE /
GAS VALVE MINISIT
MANUAL

RTC900062:

MBM- EUROTEC SRL



4146012 VALVOLA
EUROSIT CATER. 110-
190 /
EUROSIT VALVE 110-
190

60142: ILSA SPA

K22181: A.T.A. SRL

MACM097000:

MARENO

INDUSTRIE

0630337: SIT

EX0630313: SIT

0630332: SIT

35271809:

BERTO'S SPA

5018900958:AMBAC

H

MACM09700: OLIS

X12900: GIGA

MACM097000:

OLIS DIVISIONE DI

ALI GROUP SPA -

MACM097000:

SILKO ALI SPA

8219900:

POLARIS/BARON

ALI S.P.A.

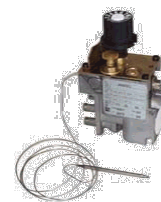

SENSORE=Ø
4X208mm

4146038 VALVOLA
MINISIT 100-340 /
VALVE MINISIT 100-
340

RTC900063:

MBM- EUROTEC SRL
- DIV. COOKING

SERVICE

0710652: SIT

OC0529:ELECTROLUX

X



=1129146,
SENSORE=Ø 5X62mm

4146082 EUROSIT
CATERING (120) 110-
190 con nuova Manopola
/

EUROSIT CATERING
(120) 110-190 with new
knob

CRO508680:

OLIS DIVISIONE DI

ALI GROUP SPA -

CRO508680:

MARENO

INDUSTRIE

CRO508680:

SILKO ALI SPA



SENSORE=Ø
4X206mm

4146042 VALVOLA
MINISIT 100-340 RP /
MINISIT VALVE 100-
340 RP

BN6A011601:

OLIS DIVISIONE DI

ALI GROUP SPA -

0100855:

SILKO ALI SPA

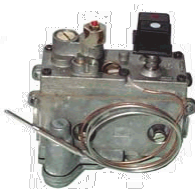

X=3108001,Y=4146008
, Z= 1129146,
SENSORE=Ø 5X62mm

4146025 VALVOLA
EUROSIT FORNO T°
40-280 /

OVEN EUROSIT

VALVE T° 40-280

0100879:

SILKO ALI SPA

KVL0007:

SILKO ALI SPA

SIRO100879:

ALI SPA

SIRKVL0007:

SILKO ALI SPA



SENSORE=Ø 4X73mm

S&P Cooking Catalogue 2017

4146065 EUROSIT
CATERING (120) 60-
300 CON NUOVA
MANOPOLA /
EUROSIT CATERING
VALVE (120) 60-300
WITH NEW KNOB
A00406:
MBM- EUROTEC SRL
058772:
ELECTROLUX



SENSORE=Ø 4X73mm

4146062 EUROSIT
CATERING (120) 100 -
340 °, CON NUOVA
MANOPOLA IN
OTTONE /
VALVE EUROSIT
CATERING (120) 100 -
340 ?
12023415: FAGOR
R152102000EX:
FAGOR
3041720:
ANGELO PO



SENSORE=Ø 4X73mm

4146048 EUROSIT
CATERING (120) 80 -
320 CON NUOVA
MANOPOLA /
EUROSIT VALVE
(120)80-320
3518912246:
AMBACH
6300477: ANGELO
PO



SENSORE=Ø 4X73mm

4146001 VALVOLA
SIT NOVA 820 /
SIT VALVE NOVA 820
MA1870800:
MARENO
002606:
ELECTROLUX
16100005:
ELFRAMO SPA
MA1870800:
SILKO ALI SPA
0820301: SIT
30100014:
LOTUS SPA



cabl=1107152

4146002 VALVOLA
EUROSIT 100-340
B4X72 /
EUROSIT VALVE 100-
340 B4X72
K22191: A.T.A. SRL
EX0630315: SIT
0630326: SIT
EX0630310: SIT
MA1887600:
MARENO
0630331: SIT
MA1887600: OLIS
***: ELECTROLUX**
T982100000:
FAGOR
1887600:
SILKO ALI SPA
0100873:
SILKO ALI SPA
062294:
ELECTROLUX

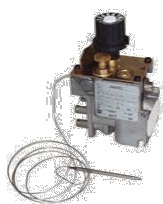

SENSORE=Ø 4X73mm

4146014 VALVOLA
820 NOVA 9X1
220/240V L.A.4+-1 /
VALVE 820 NOVA 9X1
220/240V L.A.4+-1
RTCOFC00095: MBM
0820010: SIT
MA2863300:
MARENO
5018909590:
AMBACH
33A0460:
ANGELO PO GRANDI
56514-055446:
ELECTROLUX
055446:
ELECTROLUX
0109010:
SILKO ALI SPA
32271300:
BERTO'S SPA
0000X11400:GIGA
7020070:
GIORIK SPA
1020070: GIORIK



= 1124093

4146017 VALVOLA
EUROSIT 100-340° /
EUROSIT VALVE
0630317
EX0630317: SIT
0630336: SIT



SENSORE=Ø 4X73mm

4146091 EUROSIT
CATERING (120) 110 -
190 °, con nuova
Manopola in ottone /
VALVE EUROSIT
CATERING (120) 110 -
190 °



SENSORE=Ø
4X205mm

4146021 VALVOLA
820mV SIT 0820303 /
VALVE 820mV SIT
0820303
0820303: SIT



1124093

4146045 820 NOVA
9X1 220/240V NO L.A.
RP 5-50 /
NOVASIT VALVE 820
9X1 220/240V



= 1124093

4146055 827 NOVA -
220V 2-20 MBAR, L.A.
4+-1 /
GAS VALVE 827
NOVA 220V 2-20
MBAR, L.A. 4+-1
0827110: SIT



4146040 VALVOLA
NOVA 820 9X1 /
VALVE NOVA 820 9X1
K00055: A.T.A. SRL
0820018: SIT
MA1871200:

MARENO
INDUSTRIE ALI SPA
BN6A050010:

OLIS DIVISIONE DI
ALI GROUP SPA -
X163000000EX:

FAGOR
INDUSTRIALE S.R.L.
12024768:

FAGOR
INDUSTRIALE S.R.L.
MA1871200:

OLIS DIVISIONE DI
ALI GROUP SPA -
MA1871200:

SILKO ALI SPA



4146051 VALVOLA
GAS 826 NOVA LA
220V 50 HZ /
GAS VALVE 826
NOVA LA 220V 50 HZ
RTFOC00577:

MBM- EUROTEC SRL
- DIV. COOKING
SERVICE

0826011: SIT

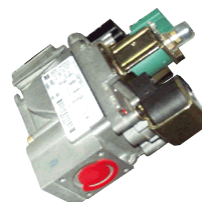

4146030 VALVOLA
822 NOVA 220V NO
L.A. /
VALVE NOVA 822
220V NO L.A.
J02VLV822:

EMMEPI GRANDI
CUCINE S.R.L.
0822114: SIT
002903:

ELECTROLUX
PROFESSIONAL
S.P.A.

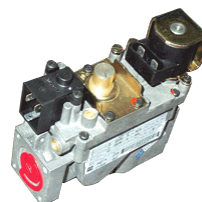

4146060 VALVOLA
GAS 820 NOVA ø
1/2"FF 230V /
"GAS VALVE 820
NOVA ? 1/2"FF 230V"

0820034: SIT
003719:

ELECTROLUX
PROFESSIONAL
S.P.A.



4146046 832
TANDEM 240V 50HZ
RP no pilot /
VALVE 832 TANDEM
240V 50HZ RP no pilot
0836010: SIT
002714:

ELECTROLUX
PROFESSIONAL
S.P.A.

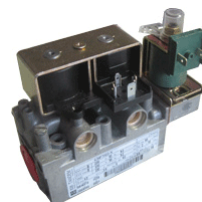

4146068 821 NOVA
9X1 220/240V L.A. 2-3
MBAR CON
STABIZZATORE HL /
VALVE 821 NOVA
9X1 220/240V L.A. 2-3
MBAR WITH
STABILIZER HL

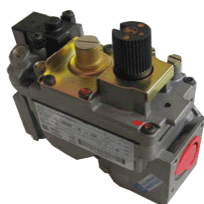

4146086 830
TANDEM 24V 50 Hz
Low Energy RP /
830 TANDEM 24V 50
Hz Low Energy RP

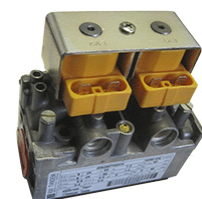

4146054 825 NOVA
24V 5-37 MBAR /
VALVE 825 NOVA 24V
5-37 MBAR

0825031: SIT
059032:

ELECTROLUX
PROFESSIONAL
S.P.A.

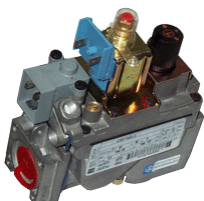

4117495 CORPO
VALVOLA SIT
TANDEM 0830041 /
VALVE SIT TANDEM
0830041

0830041: SIT
7020080:
GIORIK SPA



4146052 VALVOLA
GAS 837 TANDEM
220/240V 50HZ 5-37
MBAR 28VCC /
GAS VALVE 837
TANDEM 220/240V
50HZ 5-37 MBAR
28VCC
0837013: SIT

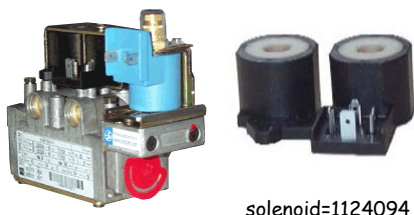

solenoid=1124094

4146080 VALVOLA
SIGMA 840 MM, NO
LA, 230V 50 Hz B+J, NO
PILOT /
VALVE SIGMA 840
MM, LA NO, 230V 50
Hz B + J, NO PILOT
005757:
**ELECTROLUX
PROFESSIONAL
S.P.A.**



4146027 VALVOLA
ELETTROSIT
PULS.CORTI 3/4 /
ELETTROSIT VALVE
3/4
0810138: SIT
0A2035:
**ELECTROLUX
PROFESSIONAL
S.P.A.**



4146039 VALVOLA
COMPOSIT 220/240V
USC.3/8 INF.
MANOPOLA
SABBIA/NERA /
COMPOSIT VALVE
220/240V 3/8
BEIGE/BLACK KNOB

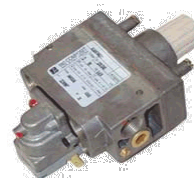

4146026 VALVOLA
ELETTROSIT
PULS.LUNGHY 3/4 /
ELETTROSIT VALVE
LONG PUSH-BUTTON
3/4
0810175: SIT
MA1450100R:
**MARENO
INDUSTRIE ALI SPA**
057543:
**ELECTROLUX
PROFESSIONAL
S.P.A.**
0100883:
SILKO ALI SPA
7020060:
GIORIK SPA
R63025030-502031:
LAINOX ALI SPA



4146035 VALVOLA
SIMPLOSIT 3/8 RQ /
SIMPLOSIT VALVE 3/8
RQ
0500015: SIT



4146008 GRUPPO
MAGNETE AC/2
MINISIT 9x1 /
MAGNET SET AC/2
MINISIT



4146016 GRUPPO
MAGNETICO
N.OTTONE 10X1 /
BRASS MAGNET SET
10X1
0006442: SIT



4146029 VALVOLA
ELETTROSIT 1/2" 220V
PULS.LUNGHY /
ELETTROSIT VALVE
LONG PUSH-BUTTON
1/2 220V
0810136: SIT
**5018902787: AMBAC
H**
0C4884:
ELECTROLUX
R630250020:
LAINOX ALI SPA
50203151:
LAINOX ALI SPA
RTBF800077:
MBM- EUROTEC SRL
**- DIV. COOKING
SERVICE**



4146076 GRUPPO
MAGNETICO
NORMAL D.19,8
OTTUR. (820 NOVA) /
NORMAL GROUP
MAGNETIC D.19, 8
SHUTTER. (820 NOVA)
0006245: SIT



4217006 GRUPPO
MAGNETICO /
GROUP MAGNETIC
30104000010: SIT



4146067 VALVOLA
GAS; 110-190 C" /
GAS VALVE 110-190
C"

OC0624ex:
ELECTROLUX
PROFESSIONAL
S.P.A.
OC5248:
ELECTROLUX
PROFESSIONAL
S.P.A.



SENSORE=Ø
4X165mm

4146075 VALVOLA
GAS /
GAS VALVE
VK4105A1118:
HONEYWELL
005925:
ELECTROLUX



4146078 VALVOLA
GAS /
GAS VALVE
LAR63020170:
LAINOX ALI SPA
LAR63020170:
OLIS DIVISIONE DI
ALI GROUP SPA -



4146061 VALVOLA
GAS 100-340°; GV30T-
C3A7A2K6E0/1; FRY
TOP /
GAS VALVE GV30T-
C3A7A2K6E0/1; FRY
TOP
OC5246:
ELECTROLUX
PROFESSIONAL
S.P.A.

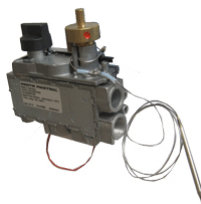

SENSORE=Ø 4X66mm

4146084 SIGMA 848
MM Electrolux - Biasi -
Turk Demir Dokum -
Robur 3/4" /
VALVE 848 SIGMA ø
3/4"MM

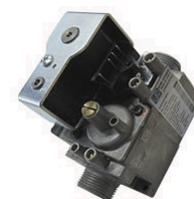

4146077 VALVOLA
GAS /
GAS VALVE
OC5250:
ELECTROLUX
PROFESSIONAL
S.P.A.
OC1729:
ELECTROLUX
PROFESSIONAL
S.P.A.



SENSORE=Ø
4X68mm,
KNOB=3108547

4146088 VALVOLA
GAS
VK4115V1014(GA282) /
GAS VALVE
VK4115V1014(GA282)
GA28600:
OEM ALI SPA

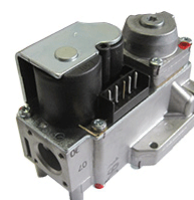

4146033 VALVOLA
HONEYWELL V4600C
/ VALVE
HONEYWELL V4600C
V4600C1029:
HONEYWELL
V4600C1086U:
HONEYWELL



4146074 MOSTRINA
VALVOLA GAS GWT
820MV /
GAS VALVE TRIM
GWT 820MV
00038675:
ELFRAMO SPA



4146058 VALVOLA
GAS HONEYWELL
VK4105C 1009 4 /
GAS VALVE
HONEYWELL
VK4105C 1009 4
809510:
EMMEPI GRANDI
CUCINE S.R.L.
R63020150:
GIGA GRANDI
CUCINE SRL
R63020150:
LAINOX ALI SPA
LAR63020150:
LAINOX ALI SPA



1129042 ELEMENT
O MINISIT 30-100 LG.
1050mm /
SENSITIVE ELEMENT
MINISIT 30-100 LG.
1050mm
0928567: SIT
056646:
ELECTROLUX

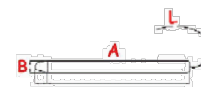

A = 122 mm, B = 5 mm

1129001 ELEMENT
O SENSIBILE
FRIGGITRICE 50-190 /
FRYER SENSITIVE
ELEMENT
0928566: SIT
531104100:
LOTUS SPA
MA24021799:
MARENO
*MBM- EUROTEC
SRL - DIV.
COOKING SERVICE

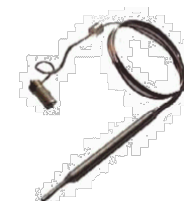

A = 95 mm, B = 5 mm

1129033 ELEMENT
O MINISIT 100-200
L1050 /
SENSITIVE ELEMENT
MINISIT 100-200
L1050
531014100:
LOTUS SPA
0928586: SIT

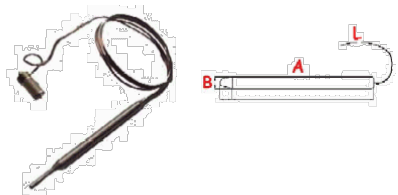

A = 107 mm, B = 6 mm

1129002 ELEMENT
O SENSIBILE
FRIGGITRICE
ELFRAMO /
FRYER SENSITIVE
ELEMENT ELFRAMO
16100030:
ELFRAMO SPA

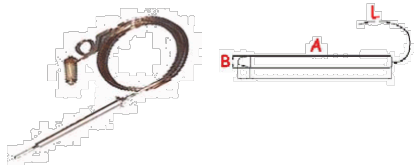

A = 95 mm, B = 6 mm

1129024 ELEMENT
O SENS. 110-190°
BOTTONE /
BUTTON SENSITIVE
ELEMENT 110-190°
0928102: SIT
0100853:
SILKO ALI SPA

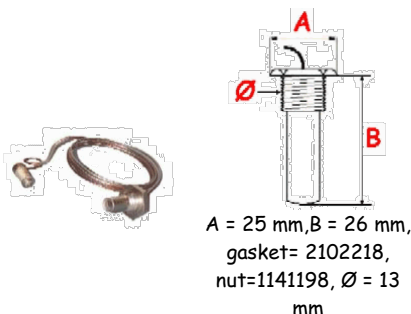

A = 25 mm, B = 26 mm,
gasket= 2102218,
nut=1141198, Ø = 13
mm

1129146 ELEMENT
O SENSIBILE 1750mm
100-340°C /
SENSITIVE ELEMENT
1750mm 100-340°C
0928563: SIT

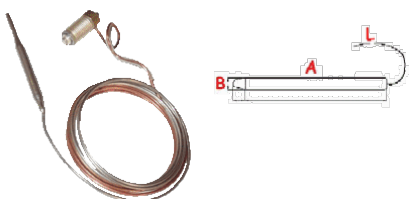

A = 62 mm, B = 5 mm

1129022 ELEMENT
O MINISIT 100-340
L.105 /
SENSITIVE ELEMENT
MINISIT 100-340 L.105
531014000:
LOTUS SPA
MA24021699:
MARENO
INDUSTRIE ALI
SPA
0928582: SIT
A011709:
SILKO ALI SPA

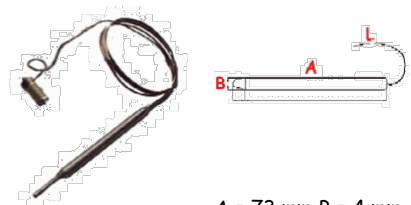

A = 73 mm, B = 4 mm

1129297 SONDA
AL CUORE /
CORE PROBE
3139610:
ANGELO PO
GRANDI CUCINE
SPA

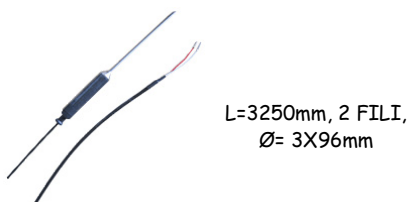

L=3250mm, 2 FILI,
Ø= 3X96mm

1129141 TERMORE
SISTENZA PT100 /
THERMO HEATING
ELEMENT PT100
32Z1983:
ANGELO PO
GRANDI CUCINE
SPA



1129142 TERMORE
SISTENZA PT100 APO
3 FILI PER FORNO /
TEMPERATURE
SENSOR PT100 A.PO
32Z6041:
ANGELO PO
GRANDI CUCINE
SPA



1129202 KIT
SONDA AL CUORE
LIVELLO 2 /
CORE
TEMPERATURE
SENSOR
6300643:
ANGELO PO
GRANDI CUCINE
SPA



1129192 KIT
SONDA AL CUORE
LIVELLO 3 /
PROBE KIT LEV. 3
6300644:
ANGELO PO
GRANDI CUCINE
SPA



1129023 SONDA
TERMORESISTENZA
32Z6191 /
THERMO HEATING
ELEMENT PROBE
32Z6191
32Z6191:
ANGELO PO
GRANDI CUCINE
SPA



1129148 SONDA
THERMOSTATO
DIGITALE CB 0.250° /
DIGITAL
THERMOSTAT
PROBE CB 0-250°
GVE- FP: CB SRL



1129149 SONDA
THERMOSTATO
DIGITALE CB 0-99° /
DIGITAL
THERMOSTAT
PROBE CB 0-99°
EV-VR-ESP/2: CB
SRL



1129257 SONDA
TCK PER FORNI TH/D
- VIP /
TCK PROBE FOR
OVENS TH / D - VIP
91310215:
CUPPONE F.LLI SRL



1129018 SONDA
AUTOLIVELLO
125MM /
AUTOLEVEL BORE
125MM
20251:
CMA MACCHINE
PER CAFFE' SRL



1129197 SONDA /
PROBE
087692:
ELECTROLUX
PROFESSIONAL
S.P.A.
092177:
ELECTROLUX
PROFESSIONAL
S.P.A.



1129287 SONDA DI
SICUREZZA
COMPLETA /
COMPLETE
SECURITY PROBE
793103610: GICO
SPA



1129168 SONDA
NTC CAVO 1,5M
D.6X30 /
PROBE NTC 1,5M D.
6X30
6000100: GIORIK
SPA



1129288 ASSIEME
SONDA LIVELLO /
COMPLETE LEVEL
PROBE
793103600: GICO
SPA



1129208 SONDA
TCJ CAVO 1ML
TERM. THERMOSI. /
PROBE TCJ CABLE
1ML THERM.
6000095:
GIORIK SPA



1129186 SONDA
SPILLONE; AOSQ
T.C.MULTIPOINT /
PLUNGE SENSOR
0C4240:
ELECTROLUX
PROFESSIONAL
S.P.A.



1129135 SONDA
PER FORNO PIZZA
SRH33 /
PIZZA OVEN PROBE
SRH33
ED065: OEM ALI
SPA

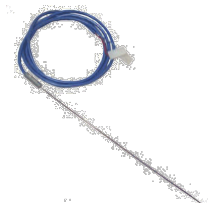

1129199 SONDA
SPILLONE PT1000 /
TEMPERATURE
SENSOR PT1000
293204010: GICO
SPA



1129276 SONDA DI
TEMPERATURA
PT100 T° -200 a
+600°C 2 FILI /
TEMPERATURE
PROBE PT100 T° -200
to + 600 ° C 2 WIRES



L=800mm,
Ø=6X100mm

1129214 SONDA/SP
ILLONE PT100
3,5X85C/CONN. /
PROBE PT100 3,5X85
6000101: GIORIK
SPA



1129277 SONDA DI
TEMPERATURA
PT100 T° -200 a +600 3
FILI /
TEMPERATURE
PROBE PT100 T° -200
to +600 3 WIRES



L=2700mm,
Ø=6X100mm

4137087 "GRIGLIA
FORNO; INOX;
530X325X12MM;
1PCS" /
GRILL OVEN; STEEL;
530X325X12MM;
1PCS"
0S0868:
ELECTROLUX
PROFESSIONAL
S.P.A.

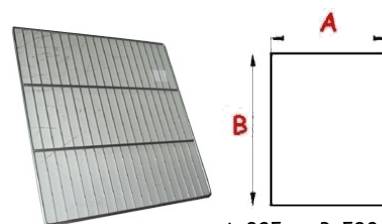

A=325mm, B=530mm

S&P Cooking Catalogue 2017

4137059 GRIGLIA
FORNO INOX
325X530 MM /
STAINLESS STEEL
GRILL FOR OVEN
325X530 MM
055428:
ELECTROLUX
PROFESSIONAL
S.P.A.

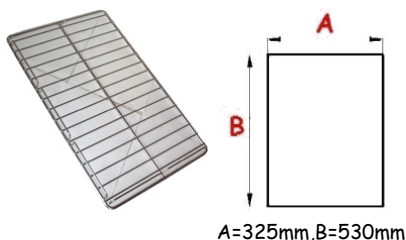

A=325mm, B=530mm

4137017 GRIGLIA
INOX 530X650mm
GN2/1 /
STAINLESS STEEL
GRID 530X650mm
GN2/1

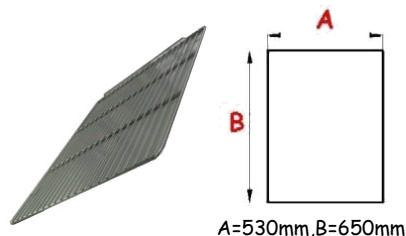

A=530mm, B=650mm

4137019 RIDUZIONE
E F/APERTI A.PO /
REDUCTION A.PO
36A5450:
ANGELO PO
GRANDI CUCINE
SPA

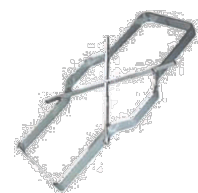

4137080 RIDUZIONE
E 205 X 205 MM /
REDUCER FOR PAN
SUPPORT
205X205MM
5010108996:
AMBACH



4137002 GRIGLIA
RIDUZIONE S.70
NICH. /
REDUCTION GRILL
S. 70 NICH.
RTC700028:
MBM- EUROTEC SRL
- DIV. COOKING
SERVICE
MA86400:
INDUSTRIE ALI
SPA
9321000:
MARENO
INDUSTRIE ALI
SPA
BN6A030100:
OLIS DIVISIONE
DI ALI GROUP SPA
-

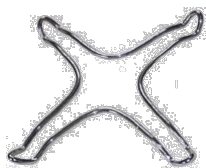

4137015 GRIGLIA
RIDUZIONE S.G4SF /
REDUCTION GRILL
S.G4SF
RTC800038:
MBM- EUROTEC SRL
- DIV. COOKING
SERVICE

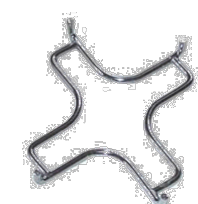

4137016 GRIGLIA
RIDUZIONE S90 /
REDUCTION GRILL
S90
RTC900055:
MBM- EUROTEC SRL
- DIV. COOKING
SERVICE

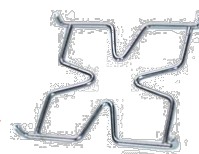

4137010 GRIGLIA
PIANO COTTURA
36A2600 /
GRILL 36A2600
36A2600:
ANGELO PO
GRANDI CUCINE
SPA



L=315mm

4137022 GRIGLIA
DI PIANO A.PO /
SURFACE GRILL
A.PO
36A0060:
ANGELO PO
GRANDI CUCINE
SPA



4137032 GRIGLIA
38X28 XD. 210 /
GRILL 38X28 D.210
36A2610:
ANGELO PO
GRANDI CUCINE
SPA



4137009 GRIGLIA
PIANO COTTURA
058179 /
STAR SHELF 058179
058179:
ELECTROLUX
PROFESSIONAL
S.P.A.



4137004 GRIGLIA
340X280 PIANO
COTTURA 002436
345X285mm /
GRILL 340X280
002436:
ELECTROLUX
PROFESSIONAL
S.P.A.



DIMENSIONS
345X285mm

4137122 "GRIGLIA
SUPPORTO
PENTOLE; GHISA"
380X370 mm /
PAN SUPPORT GRID
380x370 mm
OC0132:
ELECTROLUX
PROFESSIONAL
S.P.A.



DIMENSIONS
370X380

S&P Cooking Catalogue 2017

4137094 GRIGLIA
DI PIANO
VETRIFICATA-
700P/750 DIM. 390 X
312 /
GRID PLAN vitrified -
700P/750 DIM. 390 X
312
C00859:
**EMMEPI GRANDI
CUCINE S.R.L.**

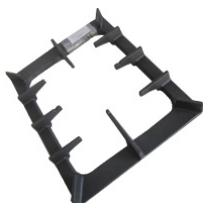

DIMENSIONS
390X312mm

4137123 GRIGLIA
FUOCHI PIANO
390x365mm /
PAN SUPPORT GRID
390X365mm
36A2002:
**ANGELO PO
GRANDI CUCINE
SPA**

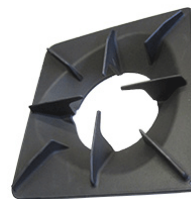

DIMENSIONS
390X365mm

4137132 GRIGLIA
DI PIANO
VETRIFICATA /
GRID
C00860:
**EMMEPI GRANDI
CUCINE S.R.L.**



DIMENSIONS
362X390mm

4137124 GRIGLIA
FUOCHI PIANO -
6029680 /
PAN SUPPORT GRID
390x365 mm
36A2002:
**ANGELO PO
GRANDI CUCINE
SPA**
36A2001:
**ANGELO PO
GRANDI CUCINE
SPA**

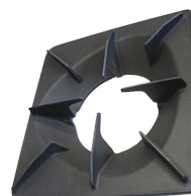

DIMENSIONS
390X365mm

4137093 GRIGLIA
355X355 SERIE 900 /
GRID 355X355 900
SERIES
**290204150: GICO
SPA**



DIMENSIONS
355X355mm

4137003 GRIGLIA
POGGIAPENTOLE
002437 /
PAN SUPPORT 002437
002437:
**ELECTROLUX
PROFESSIONAL
S.P.A.**

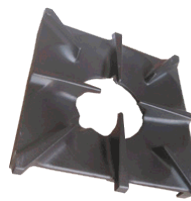

4137013 GRIGLIA
ANTERIORE
MARENO /
PAN SUPPORT
MARENO
MA1316622:
**MARENO
INDUSTRIE ALI
SPA**
1316613EX:
**MARENO
INDUSTRIE ALI
SPA**
1316622:
SILKO ALI SPA



4137006 PINZA
PER TOSTIERA /
TOASTER PLIERS
**PR40029: FABBA SRL
/: RANCILIO SPA**

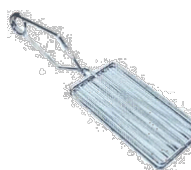

4137014 BISTECCH
IERA P3/P6 PER
TOSTIERA /
GRILL P3/P6 FOR
TOASTER
PR40034: FABBA SRL

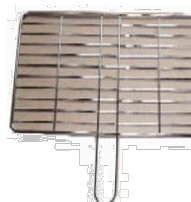

4137051 GRIGLIA
PL.G4S NERALUCRA
445X355MM /
GRILL PL.G4S
NERALUCRAAF
RTCUB00002:
**MBM- EUROTEC SRL
- DIV. COOKING
SERVICE**

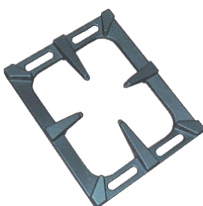

4137115 GRIGLIA
FILETTATA PER
MAXIGRILL /
GRID FOR
MAXIGRILL
PR4G008: FABBA SRL

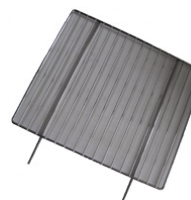

KNOB=3108564

4137097 GRIGLIA
PL.G4S7
NERA/LUC/RAAF /
GRID PL.G4S7
G4S7:
**MBM- EUROTEC SRL
- DIV. COOKING
SERVICE**



DIMENSIONS
335X300mm

4137039 GRIGLIA
PORTALAVA
426X323X20 /
GRILL FOR LAVE
STONE 426X323X20
**GRIGLIE I47-I80-
I104: CB SRL**

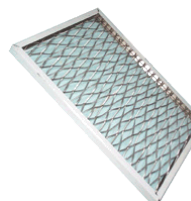

S&P Cooking Catalogue 2017

4137040 GRIGLIA
PORTALAVA
426x249x20 /
GRILL FOR LAVE
STONE 426X249X20
GRIGLIE I104 -
I126 - I65: **CB SRL**



4137067 PIASTRA
RAD.RIG.S.90 /
CAST PLATE S.90
RTC900042:
MBM- EUROTEC SRL
- DIV. COOKING
SERVICE

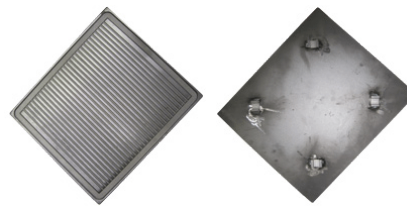

4137114 GRIGLIA
PIETRALAVICA
FIMAR
500X320X20MM /
GRILL FOR LAVE
STONE FIMAR
500X320X20MM
CO2927: **FIMAR**
S.P.A.



4137045 *GRIGLIA
LAT.F.C470 /
GRILL F.C470
RTC700029:
MBM- EUROTEC SRL
- DIV. COOKING
SERVICE

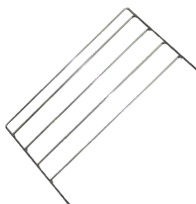

4137041 GRIGLIAT
O COTTURA CARNE
I47 /
GRILL FOR MEAT
I47
I47: **CB SRL**



4137102 GRIGLIA
PROTEZIONE VASCA
KG.20 /
GRILLE
PROTECTION TANK
kg.20
AH00700:
OEM ALI SPA

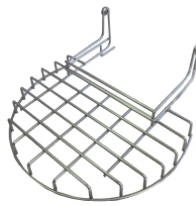

4137042 GRIGLIAT
O COTTURA PESCE
I47 /
GRILL FOR FISH I47
I47: **CB SRL**



4137126 GRID
TBX130 /
GRID TBX130
OD2704:
ELECTROLUX
PROFESSIONAL
S.P.A.



Ø F centrale/
Ø Central hole: 22mm,
Ø FORI / Ø HOLES:
10/9/8mm

4137043 GRIGLIAT
O COTTURA NUOVO
I47 /
GRILL I47
I47: **CB SRL**

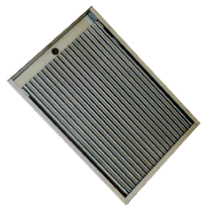

8111001 CERNIERA
FORNO ZANUSSI
050766 /
OVEN HING ZANUSSI
050766
050766:
ELECTROLUX



4137044 GRIGLIAT
O COTTURA MISTO
I80 /
GRILL I80
I80: **CB SRL**



8111002 CERNIERA
ZANUSSI 056339 /
HINGE ZANUSSI
056339
056339:**ELECTROLU**
X

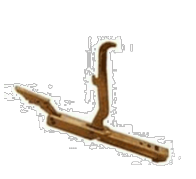

4137133 "PIASTRA
BISTECCH. RIGATA;
350X400X30 MM" /
PLATE GRILL
STRIPED 350X400X30
MM
002011:
ELECTROLUX
PROFESSIONAL
S.P.A.

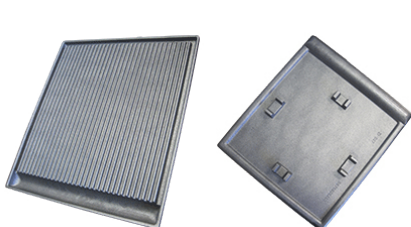

8111079 CERNIERA
PORTA; RIGHT /
RIGHT DOOR HINGE
OK3592:
ELECTROLUX
PROFESSIONAL
S.P.A.



S&P Cooking Catalogue 2017

8111080 CERNIERA
PORTA; LEFT /
OVEN HINGE
OK3593:
ELECTROLUX
PROFESSIONAL
S.P.A.



8111105 CERNIERA
PORTINA FORNO /
OVEN DOOR HINGE
059227:
ELECTROLUX
PROFESSIONAL
S.P.A.



8111115 CERNIERA
/
OVEN HINGE
OC0203:
ELECTROLUX
PROFESSIONAL
S.P.A.



8111014 CERNIERA
DX A.PO /
RIGHT HINGE A.PO
36M2420:
ANGELO PO
GRANDI CUCINE
SPA



8111015 CERNIERA
SX A.PO /
LEFT HINGE A.PO
36M2430:
ANGELO PO
GRANDI CUCINE
SPA



8111006 CERNIERA
FORNO DX MBM /
RIGHT OVEN HINGE
MBM
5012002196:
AMBACH
BN6A035910: OLIS-
X66000:GIGA
31802000:
BERTO'S SPA
0100346: SILKO
ALI
BN6A035910:
SILKO
SIR0100346:
SILKO ALI SPA
RTC900026:
MBM- EUROTEC SRL
-
531022800:
LOTUS SPA



4117024

8111007 CERNIERA
FORNO SX MBM /
LEFT OVEN HINGE
MBM
BN6A035920: OLIS
X66100: GIGA
31802100:
BERTO'S SPA
0100345: SILKO
ALI
BN6A035920:
SILKO ALI SPA
SIR0100345:
SILKO ALI SPA
5012002108:
AMBACH
RTC900027:
MBM- EUROTEC SRL
531022700:
LOTUS SPA



4117024

4117024 PORTARU
LLINO MBM /
ROLL-HOLDER MBM
531022900:
LOTUS SPA
RTC900004:
MBM- EUROTEC SRL
- DIV. COOKING
SERVICE



4117839 *P/RULLIN
O G4F6 9626105200 /
ROLLER HOLDER
G4F6 9626105200
RIC0002448:
MBM- EUROTEC SRL
- DIV. COOKING
SERVICE



4217367 CONTROS
UPPORTO CERNIERA
FORNO MBM /
DOOR HINGE ROLL
HOLDER
9626105200:
MBM- EUROTEC SRL
- DIV. COOKING
SERVICE



8111016 CERNIERA
DX MARENO /
RIGHT HINGE
MARENO
MA1304600:
MARENO
INDUSTRIE ALI
SPA
1031200100:
MARENO
INDUSTRIE ALI
SPA
1304600:
SILKO ALI SPA

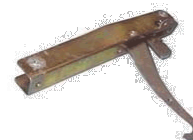

S&P Cooking Catalogue 2017

8111017 CERNIERA
SX MARENO /
LEFT HINGE
MARENO
MA1304700:
MARENO
INDUSTRIE ALI
SPA
1304700:
SILKO ALI SPA
1031200000:
MARENO
INDUSTRIE ALI
SPA



8111097 CERNIERA
INF. PORTA /
LOWER HINGE DOOR
15066: FOINOX
S.P.A.



8111126 CERNIERA
PORTA FORNO GAM
DX/SX /
OVEN HINGE DX/SX
GAM



8111090 CERNIERA
SX FORNO 126 MM /
OVEN HINGE LEFT
126MM
RICO002134:
MBM- EUROTEC SRL
-



8111003 CERNIERA
PORTA SX ZANUSSI
082219 PERNO
QUADRO LUNGO /
LEFT DOOR HINGE
ZANUSSI 082219
71101000:
MODULAR SPA
3666520: ANGELO
PO
082219:
ELECTROLUX



PERNO
QUADRO=7,5X7,5mm

8111091 *CERNIER
A DX PORTA G4F6
9626105500 /
OVEN HINGE RIGHT
G4F6 9626105500
RICO002133:
MBM- EUROTEC SRL
-



8111033 CERNIERA
SUP. SX A.PO /
LEFT HINGE A. PO
36M0350:
ANGELO PO
GRANDI CUCINE
SPA



8111124 CERNIERA
FORNO SX /
LEFT OVEN HINGE
22608100:
BERTO'S SPA



8111034 CERNIERA
SUPR.DX APO /
RIGHT HINGE A. PO
36M0340:
ANGELO PO
GRANDI CUCINE
SPA



8111125 CERNIERA
PORTA FORNO DX /
RIGHT OVEN HINGE
22607800:
BERTO'S SPA



8111096 CERNIERA
PER FORNO F.H. C.I.
9KG /
OVEN HINGE 9KG



8111032 CERNIERA
INF.SX VP A.PO /
LEFT HINGE VP A.PO
6008500:
ANGELO PO
GRANDI CUCINE
SPA



8111067 CERNIERA
FORNO /
OVEN DOOR HINGE
8111067:
BERTO'S SPA



8111064 CERNIERA
SUP.DX /
RIGHT DOOR HINGE
36M2541:
ANGELO PO
GRANDI CUCINE
SPA



3125035 CHIUSUR
A FERMAPORTA CB /
SNAP LOCK CB
10060009: **CB SRL**



3125051 CHIUSUR
A PORTA /
CATCH
002647:
**ELECTROLUX
PROFESSIONAL
S.P.A.**



3125010 SCROCCH
ETTO PORTA FORNO
LAINOX /
OVEN DOOR WHOLE
PAWL LAINOX
057414:**ELECTROLU
X.**

36M3600: **ANGELO
PO**
0285+0285B:
FOINOX S.P.A.
2000160: **GIORIK
SPA**
R69050010:
LAINOX ALI SPA
50103110: **MBM**
LAR69050010:
LAINOX ALI SPA
MA2844800R:
MARENO



3125079 BLOCCO
SUPPLEMENTARE
ART.1875 /
ADDITIONAL BLOCK
ART.1875

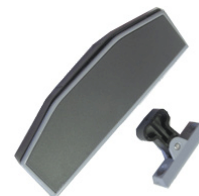

3125080 CHIUSUR
A PORTA FORNO
INTERASSE 134 MM
L 172 MM /
OVEN HANDLE
LACHT 134MM L.
172MM
C8118-00:
INOXTREND S.R.L.



3125058 ASSIEME
CHIUSURA PORTA
AOSQ 6-10 /
LOCK ASSEMBLY
FOR DOOR AOSQ 6-
10

0CA757:
ELECTROLUX
0C4477:
ELECTROLUX



3125057 MECCANI
SMO CHIUSURA SX
0751.020941 /
DOOR LOCK SX
0751.020941
5900123: **GIORIK
SPA**



3125085 MECCANI
SMO CHIUSURA
PORTA FORNO /
OVEN DOOR
LOCKING
MECHANISM



3125087 MECCANI
SMO CHIUSURA /
LOCKING
MECHANISM
006977:
**ELECTROLUX
PROFESSIONAL
S.P.A.**



3125092 MECCANI
SMO PORTA
ESTREMITA' /
OVEN HANDLE
TOP/BOT.TIE ROD
146 mm



3125044 FLANGIA
NASELLO MANIGLIA
LAINOX /
FLANGE LAINOX
R10100110:
LAINOX ALI SPA
LAR10100110:
LAINOX ALI SPA

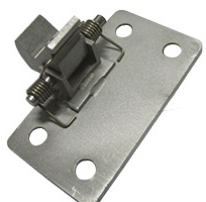

3125066 KIT
CHIUSURA PORTA
FORNO COVEN
COMPLETO /
DOOR LOCK



3125043 NASELLO
MANIGLIA R58005050
/
CLOSING HUB
R58005050
R58005050:
LAINOX ALI SPA
LAR58005050:
LAINOX ALI SPA



S&P Cooking Catalogue 2017

3125042 AS.SERRA
TURA P.F.FEC100 /
CATCH COMPLETE
FEC100

GAFOC00051:

MBM- EUROTEC SRL
- DIV. COOKING
SERVICE



3125060 AGGANCI
O PER CHIUSURA /
DOOR LOCK
COUPLING

809875:

EMMEPI GRANDI
CUCINE S.R.L.

8C0315:

EMMEPI GRANDI
CUCINE S.R.L.

1500: FOINOX

S.P.A.



3125093 CHIUSUR

E MAGNETICHE
RPV30 ZEN. /
MAGNETIC
CLOSURES RPV30
ZEN

EN14500:

OEM ALI SPA



Ø=M6, D. 32

5102040 CESTELLO
FORATO /
FRYER BASKET
380X150X125MM

36A2020:

ANGELO PO
GRANDI CUCINE
SPA

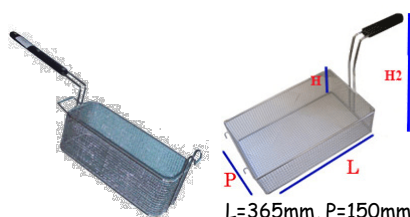

L=365mm, P=150mm,
H=120mm, H2=220mm

5107015 CESTELLO
FRIGGITRICE
370X150X120H /
FRYER BASKET
370X150X120

36A2340:

ANGELO PO
GRANDI CUCINE
SPA

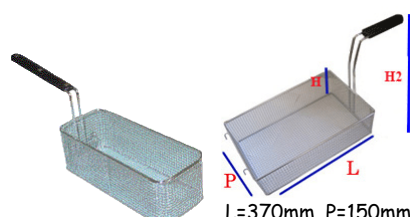

L=370mm, P=150mm,
H=120mm,
H2=225mm,

5107007 CESTELLO
FRIGGITRICE
380X150X120H /
BASKET 38X15X12

36A3491:

ANGELO PO
GRANDI CUCINE
SPA

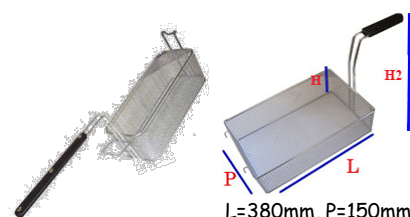

L=380mm, P=150mm,
H=120mm, H2=200mm

5107010 CESTELLO
FRIGGITRICE A.PO
300X190X115H /
FRYER BASKET A.PO
300X190X115

36A3481:

ANGELO PO
GRANDI CUCINE
SPA

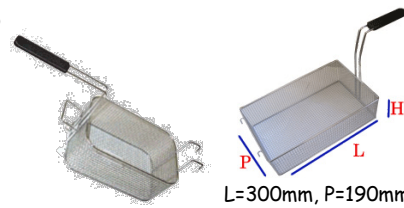

L=300mm, P=190mm,
H=115mm

5107011 FONDO
PORTA CESTELLI
A.PO /
BASKET-HOLDER
BOTTOM A.PO

36A2320:

ANGELO PO

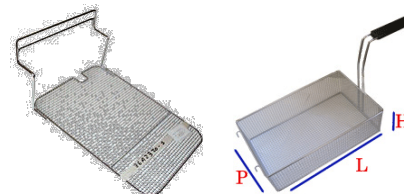

5107023 CESTELLO
FRIGGITRICE 1/2
280X130X145H /
FRYER BASKET 1/2
280X130X145MM

K26026: A.T.A. SRL

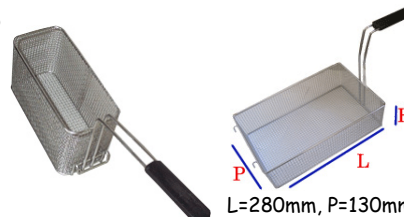

L=280mm, P=130mm,
H=145mm

5107045 CESTELLO
FRIGGITRICE
BERTO'S
300X245X110H /
FRYER BASKET
BERTO'S
300X245X110H

32617100:

BERTO'S SPA

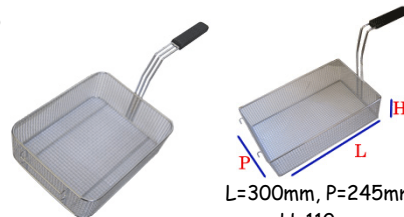

L=300mm, P=245mm,
H=110mm

5107082 CESTELLO
PER FRIGGITRICE
345X265X150H /
FRYER BASKET
345X265X150H

32502800:

BERTO'S SPA

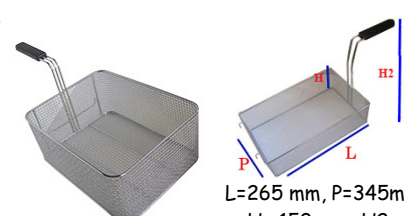

L=265 mm, P=345mm
H= 150 mm, H2=
255mm

5107086 CESTELLO
FRIGGITRICE
235X200X100 mm /
FRYER BASKET
235x200x100 mm

33614400:

BERTO'S SPA

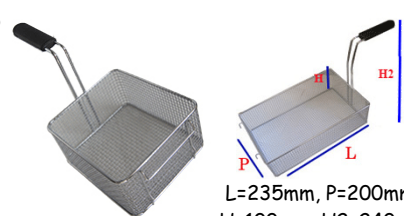

L=235mm, P=200mm,
H=100mm, H2=240mm

5107013 CESTELLO
FRIGGITRICE
343X158X159H /
FRYER BASKET
343X158X159MM

052290:

ELECTROLUX

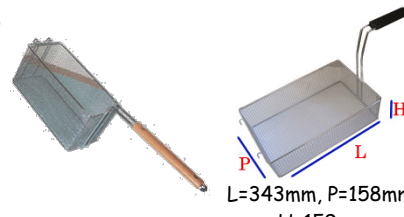

L=343mm, P=158mm,
H=159mm

S&P Cooking Catalogue 2017

5107029 CESTELLO
FRIGGITRICE
325X225X120H /
BASKET
325X225X120MM
005933:
ELECTROLUX
PROFESSIONAL
S.P.A.

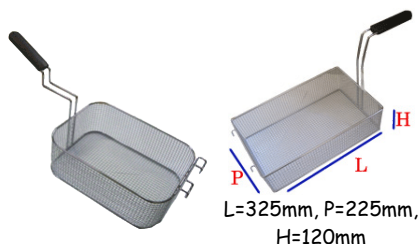

L=375mm, P=215mm,
H=125mm, H2=250mm

5107057 "CESTELLO
FRIGGITRICE 240
BASSO" /
BASKET 240 LOW
004492:
ELECTROLUX

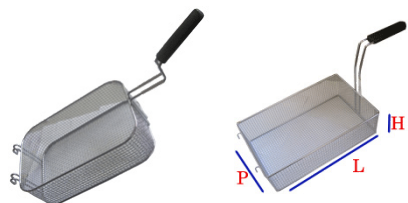

5107065 CESTELLO
FRIGGITRICE
INTERO LT 6
260X180X120H /
FRYER BASKET LT 6
(260X180)
00030560:
ELFRAMO SPA

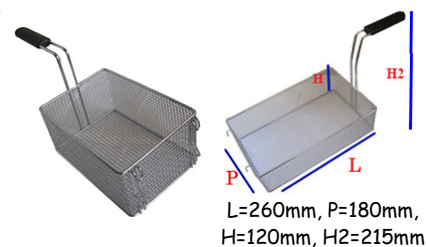

5107020 CESTELLO
FRIGGITRICE
295X200X110H /
FRYER BASKET
295X200X110MM
706089ex:
ELETTOBAR
DIVISIONE DELLA
EUROTEC SRL
706089:
MBM- EUROTEC SRL
- DIV. COOKING
SERVICE

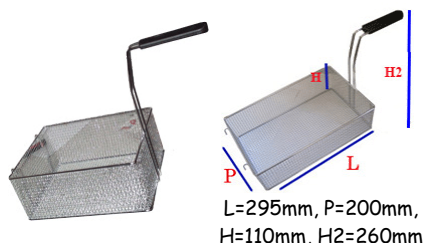

5107061 CESTELLO
FRIGGITRICE MEZZO
2532 290X105X120H /
HALF FRYER
BASKET
290x105x120mm
00035842:
ELFRAMO SPA

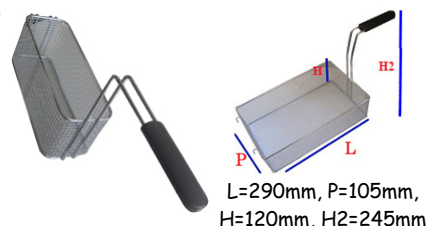

5107027 CESTELLO
FRIGGITRICE EF6BM
200X190X105H /
BASKET FRYER
EF6BM
190X200X105hX205h
161778:
ELETTOBAR
DIVISIONE DELLA
EUROTEC SRL
161778:
MBM- EUROTEC SRL
- DIV. COOKING
SERVICE

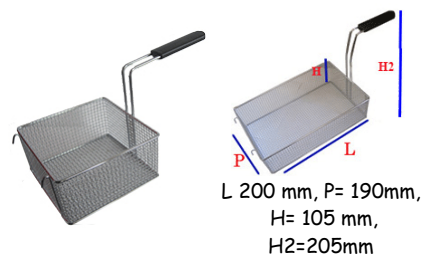

5107030 CESTELLO
INTERO PER
FRIGGITRICE LT35
540X365X125H /
FRYER BASKET LT35
- 365x540x125 mm
00030610:
ELFRAMO SPA

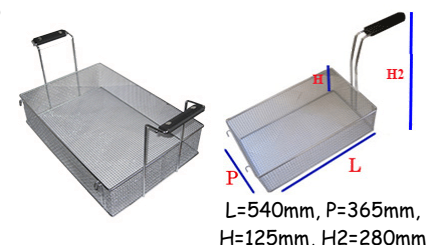

5107004 CESTELLO
FRIGGITRICE
250X210X110H /
FRYER BASKET
200X270X110
PR70005: FABA SRL

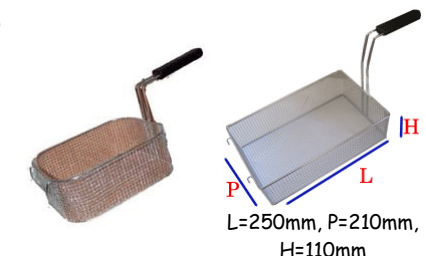

5107032 CESTELLO
FRIGGITRICE GF25S
385X235X105H /
BASKET GF25S
162057:
ELETTOBAR
DIVISIONE DELLA
EUROTEC SRL
162057:
MBM- EUROTEC SRL
- DIV. COOKING
SERVICE

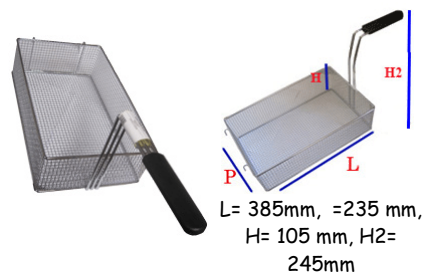

5107075 CESTELLO
FRIGGITRICE LT.12
DA 1/1
285X225X100HX215H
2 /
BASKET FOR FRYER
1/1 LT12
P225XL285X100HX21
0H2
270205500:
GICO SPA

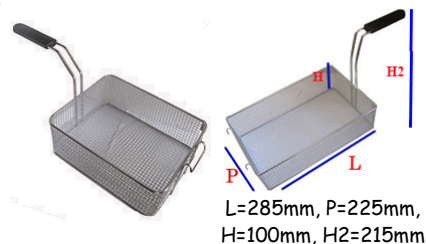

5107012 CESTELLO
FRIGGITRICE 12LT
375X215X125H /
FRYER BASKET 12lt
37.5 X21, 5X12, 5H
00035806:
ELFRAMO SPA

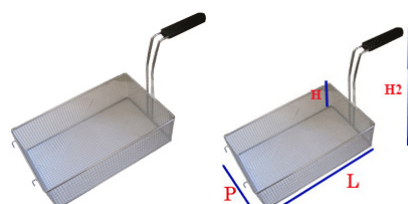

5107049 RETINA
FILTRO CROMATA
LT 7 EL /
NET FILTER LT 7 EL
X62300:
GIGA GRANDI
CUCINE SRL



S&P Cooking Catalogue 2017

5107077 CESTELLO
FRIGGITRICE
CROMATO17L
UNICO
310X300X120H /
FRYER BASKET
310x300x120 mm
2012896: **GIORIK**
SPA

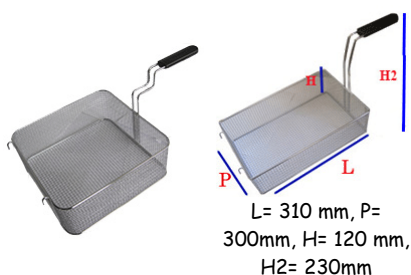

5107001 CESTELLO
FRIGGITRICE
270X260X105H /
FRYER BASKET
260X270X105H
531000800:
LOTUS SPA

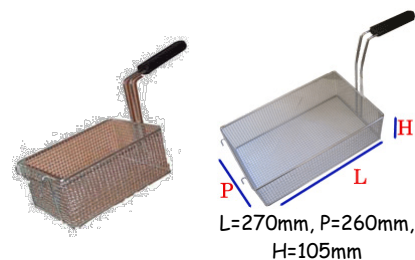

5107078 CESTELLO
FRIGGITRICE
COMPLETO FG17N
PICCOLO
290X165X120H /
FRYER BASKET
290x165x120 mm
2003008:
GIORIK SPA
A800000200:
MBM- EUROTEC SRL
- DIV. COOKING
SERVICE

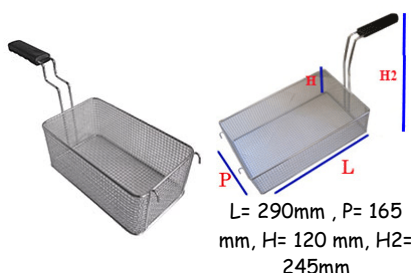

5107051 CESTELLO
CUOCIPASTA
290X140X110H /
BASKET
290X140X110MM
531024500:
LOTUS SPA

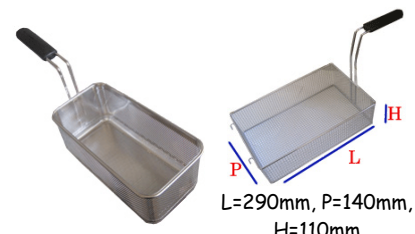

5107031 CESTELLO
FRIGGITRICE FT3N
295X120X135H /
FRYER BASKET
295X120X135 FT 3N
2103071: **GIORIK**
SPA

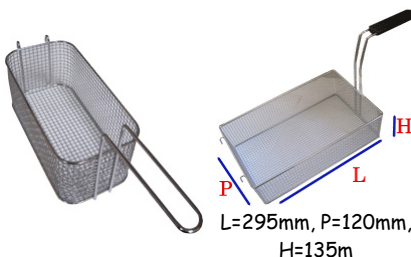

5107018 CESTELLO
FRIGGITRICE
MARENO
285X120X120H /
FRYER BASKET
MARENO
285X120X120MM
MACM030000:
MARENO
INDUSTRIE ALI
SPA

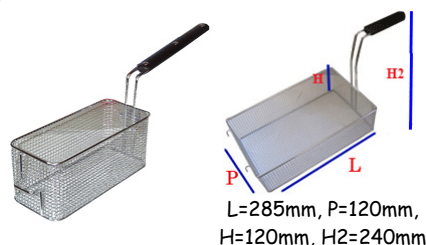

5107052 CESTELLO
FRIGGITRICE
COMPLETO FG207N
285X140X120H /
BASKET FG207N
14X28.5X12
2003001: **GIORIK**
SPA

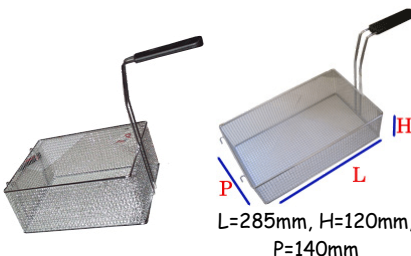

5107060 CESTELLO
FRIGGITRICE
INTERO
360X160X120H /
FRYER BASKET
ENTIRE
360X160X120MM
MACM030400:
MARENO
INDUSTRIE ALI
SPA
MACM030400:
SILKO ALI SPA

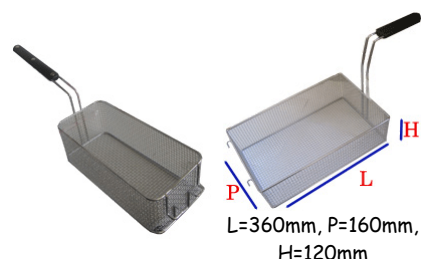

5107054 CESTELLO
FRIGGITRICE
310X145X120H /
FRYER BASKET
310X145X120H
2012895: **GIORIK**
SPA

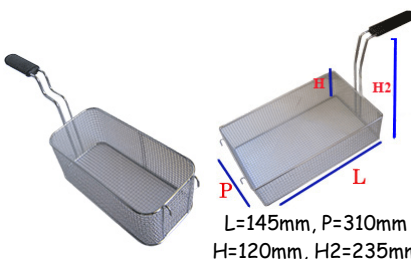

5107002 CESTELLO
FRIGGITRICE 22LT
FR9X-C22
360X160X150H /
FRYER BASKET
22LT FR9X-C22
MA1464600:
MARENO
INDUSTRIE ALI
SPA

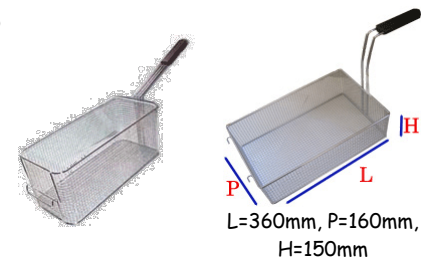

5107076 RETINA
CROMATA
FRIGGITRICE
339X304 / MESH
FALSE BOTTOM
COMPLETE 340x305
mm
2012894: **GIORIK**
SPA



5107006 CESTELLO
FRIGGITRICE
280X200X115H KFQ /
FRYER BASKET
200X280X115 KFQ
MA1031004810:
MARENO
INDUSTRIE ALI
SPA
1031004810:
SILKO ALI SPA

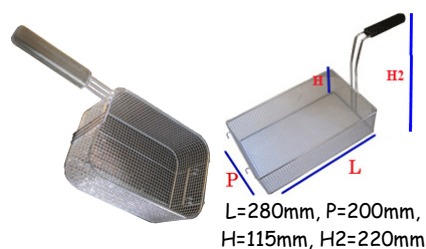

S&P Cooking Catalogue 2017

5107085 CESTELLO INTERO

FRIGGITRICE 900 - 360X325X120mm / FRYER BASKET 900 - 360X325X120mm

MACM030100:

MARENO INDUSTRIE ALI SPA

MACM030100:

SILKO ALI SPA

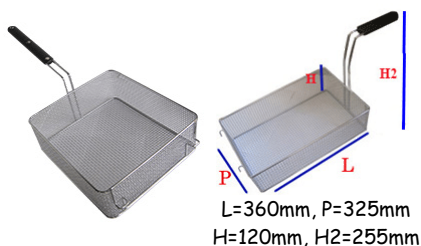

5107040 CESTELLO INTERO

FRIGGITRICE 335X285X120H / FRYER BASKET 33,5X28,5X12

A800000210:

MBM- EUROTEC SRL - DIV. COOKING SERVICE

A800000210:

ELETTROBAR DIVISIONE DELLA EUROTEC SRL

2003009:

GIORIK SPA

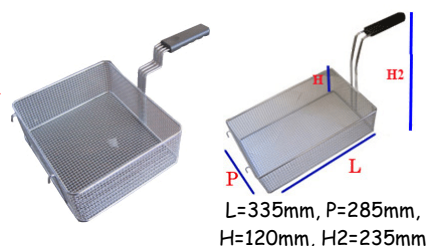

5107043 CESTELLO INTERO

FRIGGITRICE EF8BM 245X190X105H / FRYER BASKET EF8BM

161850:

MBM- EUROTEC SRL - DIV. COOKING SERVICE

161850ex:

ELETTROBAR DIVISIONE DELLA EUROTEC SRL

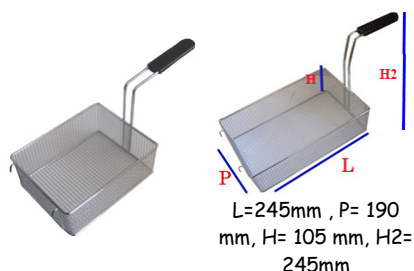

5107005 CESTELLO INTERO

FRIGGITRICE INTERO LT 12 290X240X120H / WHOLE BASKET LT 12 290X240

0101099:

SILKO ALI SPA

2003003:

GIORIK SPA

00030580:

ELFRAMO SPA

SIR0101099:

SILKO ALI SPA

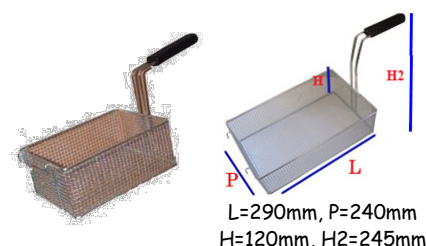

5107080 CESTELLO INTERO

FRIGGITRICE LT.10/12/14 A770046 295X260X120H / FRYER BASKET 295x260x120 mm

A770000150:

MBM- EUROTEC SRL - DIV. COOKING SERVICE

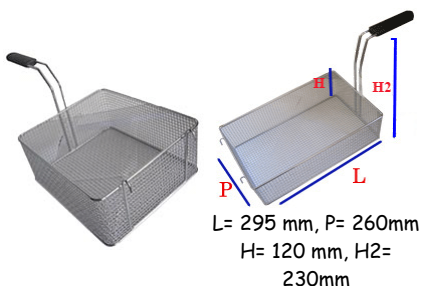

5107084 CESTELLO INTERO

FRIGGITRICE FRIFRI 345X140X155 mm / FRYER BASKET FRIFRI 345X140X155 mm

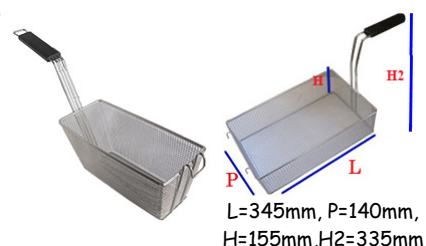

5107033 CESTELLO INTERO

FRIGGITRICE GF15S 275X235X110H / FRYER BASKET GF15S 275X235X220H

161745:

MBM- EUROTEC SRL - DIV. COOKING SERVICE

161745*:

ELETTROBAR DIVISIONE DELLA EUROTEC SRL

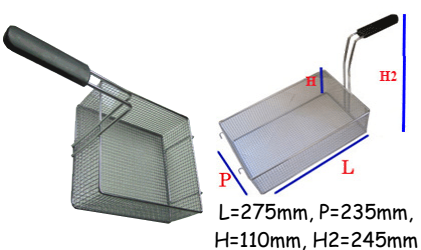

5107041 CESTELLO INTERO

FRIGGITRICE 175X220X110MM / CESTELLO FRIGGITRICE 175X220X110MM

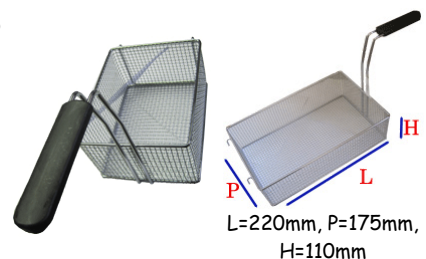

5107053 CESTELLO INTERO

FRIGGITRICE 280X220X115H / FRYER BASKET 280X220X115H

A660000310:

MBM- EUROTEC SRL - DIV. COOKING SERVICE

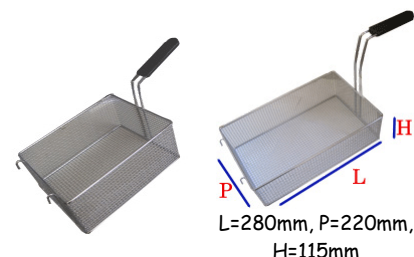

5107009 CESTELLO INTERO

CUOCIPASTA A.P.O 290X100X150H / BASKET FOR PASTA A.P.O

30CPS,30CPSE,70CP,71CP,70CPE,71CPE,90CP,91CP:

ANGELO PO GRANDI CUCINE SPA

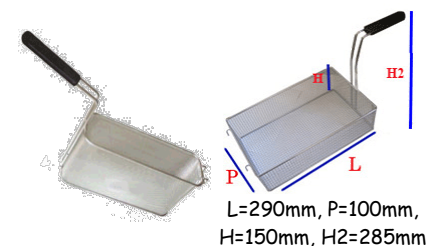

S&P Cooking Catalogue 2017

5107069 CESTELLO
CUOCIPASTA
ANGELO PO
306X115X205H /
PASTA COOKER
BASKET
306X115X205MM
ANGELO PO

C3011:

ANGELO PO
GRANDI CUCINE
SPA

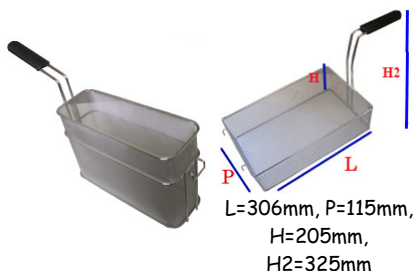

5107028 CESTELLO
CUOCIPASTA
250X105X245H /
BASKET
250X105X245MM

31614800:

BERTO'S SPA

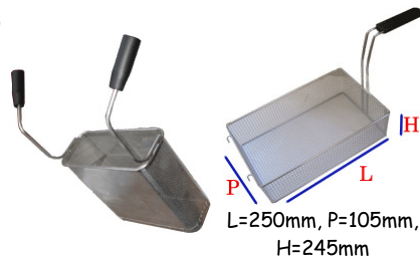

5107021 CESTELLO
CUOCIPASTA MBM
1/3 CON 2 MANICI
290X160X215H /
BASKET FOR PASTA
MBM 1/3
160X290X215MM

A80001260:

MBM- EUROTEC SRL
- DIV. COOKING
SERVICE

A800104:

MBM- EUROTEC SRL
- DIV. COOKING
SERVICE

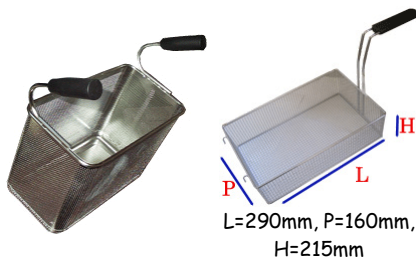

5107036 CESTELLO
CUOCIPASTA OLIS
DX 155X155X240H /
RIGHT BASKET
CUOCIPASTA OLIS
140X140X180MM

BN2510533:

OLIS DIVISIONE
DI ALI GROUP SPA
-

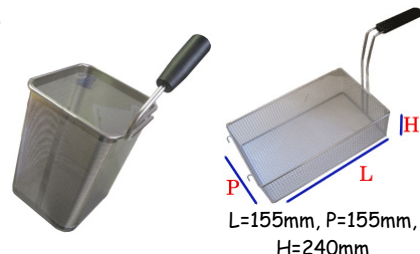

5107037 CESTELLO
CUOCIPASTA OLIS
SX 155X155X240H /
BASKET OLIS SX
140X140X180MM

BN2510536:

OLIS DIVISIONE
DI ALI GROUP SPA
-

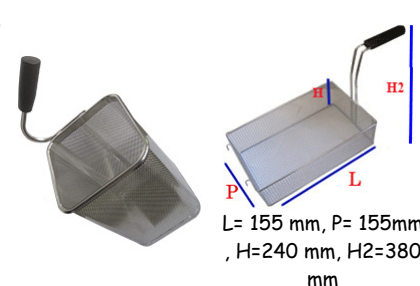

5107073 CESTELLO
CUOCIPASTA INOX
1/3 B800006
290X160X200H /
B800006. PASTA
COOKER BASKET 1/2
16X29X21,5 INOX

A800000810:

MBM- EUROTEC SRL
- DIV. COOKING
SERVICE

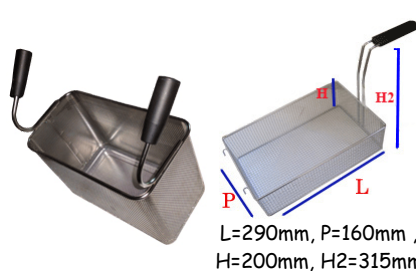

5107038 KIT
CESTELLO SX -DX
CUOCIPASTA
140X140X200H /
KIT BASKET - SX -DX
FOR PASTA COOKER
140X140X200H

005806:

ELECTROLUX
PROFESSIONAL
S.P.A.

0C6291:

ELECTROLUX
PROFESSIONAL
S.P.A.

005807:

ELECTROLUX
PROFESSIONAL
S.P.A.

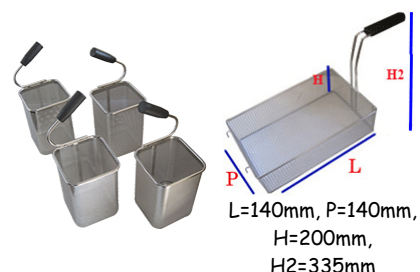

5107024 CESTELLO
CUOCIPASTA DX
160X140X215H /
RIGHT BASKET
140X160X215

*****:

MBM- EUROTEC SRL
- DIV. COOKING
SERVICE

A800000780:

MBM- EUROTEC SRL
- DIV. COOKING
SERVICE

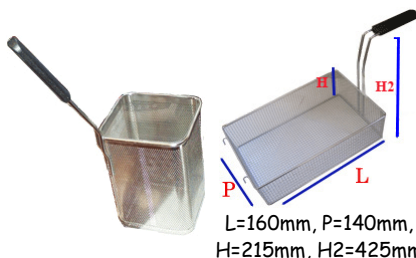

5107025 CESTELLO
CUOCIPASTA SX
160X140X215H /
LEFT BASKET
140X160X215

B800004:

MBM- EUROTEC SRL
- DIV. COOKING
SERVICE

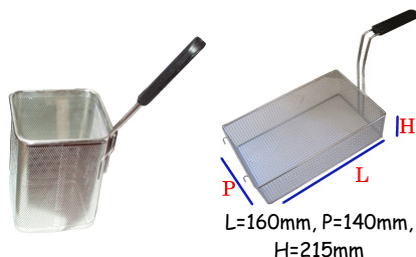

5107039 CESTELLO
DX CUOCIPASTA
140X140X200H /
BASKET -DX FOR
PASTA COOKER
140X140X200H

ELECTROLUX
PROFESSIONAL
S.P.A.

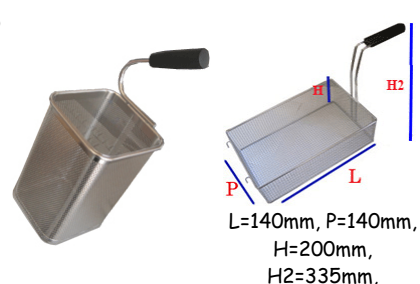

S&P Cooking Catalogue 2017

5107056 "CESTELLO
O CUOCIPASTA
275X150X210H 2
GRIF" 1/3 seire 900 /
BASKET
275X150X210H 2 GRIF
1/3 SERIES 900

OC1340:

**ELECTROLUX
PROFESSIONAL
S.P.A.**



L=275mm, P=150mm,
H=210mm

5107087 CESTO
CUOCIPASTA INOX
230X180X265mm /
BASKET FOR PASTA
230X180X265mm

004875:

**ELECTROLUX
PROFESSIONAL
S.P.A.**

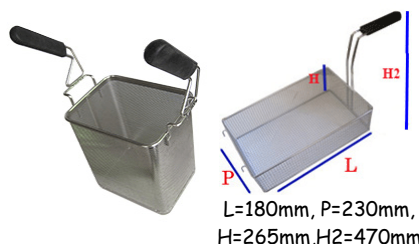

L=180mm, P=230mm,
H=265mm, H2=470mm

5107070 CESTELLO
CUOCIPASTA 1/2 serie
900 230X275X210H /
PASTA COOKER
BASKET;
275X230X210 MM" 1/2
series 900

OC1339:

**ELECTROLUX
PROFESSIONAL
S.P.A.**



L=230mm, P=275mm,
H=210mm

5107046 CESTELLO
CUOCIPASTA 1/6
140X140X200H
SINISTRO /
PASTA COOKER
BASKET 1/6
140X140X200H LEFT

205075:

**EMMEPI GRANDI
CUCINE S.R.L.**

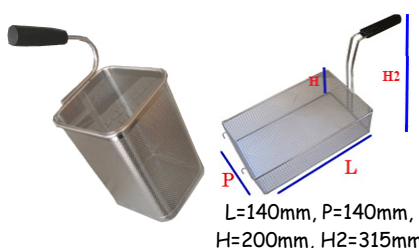

L=140mm, P=140mm,
H=200mm, H2=315mm

5107047 CESTELLO
CUOCIPASTA 1/6
140X140X200H
DESTRO /
BASKET FOR PASTA
1/6 140X140X200MM
DX

507046:

**EMMEPI GRANDI
CUCINE S.R.L.**

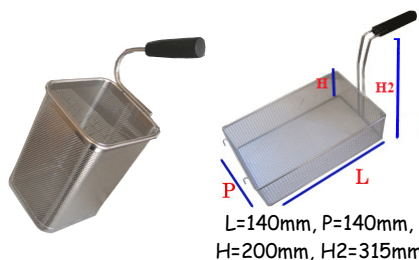

L=140mm, P=140mm,
H=200mm, H2=315mm

5107079 CESTELLO
CUOCIPASTA 2/9 CP
70/02 290X100X215H /
PASTA COOKER
BASKET 290x98x215
mm

BN2519571:

**OLIS DIVISIONE
DI ALI GROUP SPA**

-

A800000800:

**MBM- EUROTEC SRL
- DIV. COOKING**

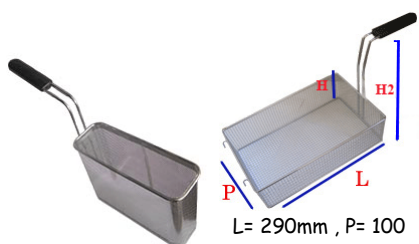

L= 290mm , P= 100
mm, H= 215 mm,
H2=360mm,

SERVICE

5107088 CESTELLO
CUOCIPASTA
240X290X200H 1/2 /
BASKET FOR PASTA
240X290X200H 1/2

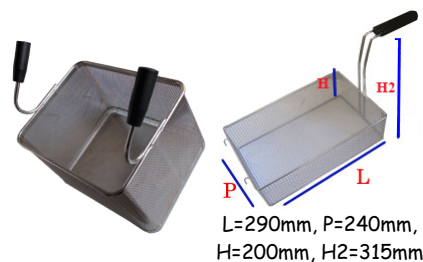

L=290mm, P=240mm,
H=200mm, H2=315mm

5107016 CESTELLO
HOT DOG, SW1 CB /
HOT DOG BASKET
SW1 CB

**HOT DOG- SW1:
CB SRL**



5107017 PENTOLIN
O TEFLONATO /
TEFLON POT

**HOT DOG - SW1:
CB SRL**



6101086 ADDOLCI
TORE AUTOMATICO
CABINATO MINICAB
5LT 713 F79B A
VOLUME /
AUTOMATIC
VOLUMETRIC
WATER SOFTENER -
CABINET minicab 5
LT 713 F79B



P=425mm, H=465mm,
H aperto=560mm,
L=240mm,
KIT=6101087,
A=6101105, B=6101106
C=6101107, D=6101102

6101089 ADDOLCI
TORE AUTOMATICO
CABINATO
VOLUMETRIC LT12
F79BS /
VOLUMETRIC
WATER SOFTENER -
CABINET LT 12
F79BS



P=530mm, H=600mm,
H aperto=700mm,
KIT=6101087,
L=330mm,
A=6101105, B=6101106
C=6101107, D=6101102

6101105 VALVOLA RUNXIN F79B VOLUME 3/4"UF/DF PISTONE WBP CON ACCESSORI (preset 5litri) / VOLUMETRIC VALVE RUNXIN F79B 3/4"UF/DF PISTON WBP WITH ACCESSORIES (preset 5L)



TRASFORMATORE=6101103

6101103 TRASFORMATORE PER VALVOLA TMF-EU 220/12 DC 1A / TRANSFORMER FOR VALVE TMF-EU 220/12 DC 1A



6101102 SCHEDA ELETTRONICA DI CONTROLLO PER VALVOLA F79 / ELECTRONIC CONTROL BOARD FOR F79 VALVE



6101106 SCHEDA ELETTRONICA DISPLAY PER VALVOLA F79 / DISPLAY P.C. BOARD FOR F79 VALVE

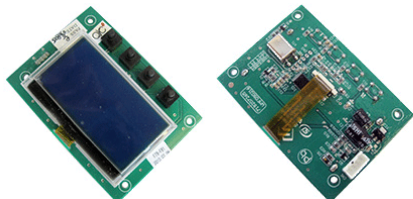

6101107 MOTORINO PER F63C/F68C / MOTOR FOR F63C/F68C



6101087 KIT DISINFEZIONE DELLE RESINE PER VALVOLA RUNXIN / KIT DISINFECTION RESINS VALVE Runxin



6101101 COPPIA RACCORDI 3/4" CONTATORE PER VALVOLA F79 / PAIR METER JUNCTION 3/4" FOR F79 VALVE



O-RING=6101099

6101109 KIT O-RING TANK-PORTAGOMMA BLFC DADO 3/8 / KIT O-RING TANK-RUBBER-HOLDER BLFC NUT 3/8



G.PIATTA=19X5X3mm, O-RING Ø=72,5X5,12mm

6101099 O-RING RACCORDO 3/4" CONTATORE PER VALVOLA F79 / O-RING METER JUNCTION 3/4" FOR F79 VALVE



Ø=19,3X2,62mm, RACCORDO=6101101

6101104 TURBINA CONTATORE PER VALVOLA F79 / METER FAN FOR F79 VALVE



H=13mm, Ø=23mm

6101036 ADDOLCITORE 8LT VOLUMETRICO C/KIT DISINFEZIONE RESINE / VOLUMETRIC WATER-SOFTNER 8LT

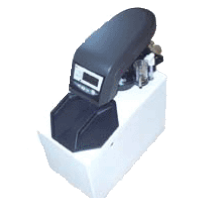

KIT TESTATA=6101018, KIT MEMBRANE=6101019, TIMER=1112314

6101035 ADDOLCITORE 8LT LOGIX CABINATO 255/740 / AUTOMATIC WATER-SOFTNER 6L LOGIX

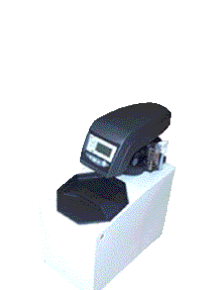

L=230mm, P=440 mm, H=540 mm, TIMER=1112314, KIT TESTATA=6101018, KIT MEMBRANE=6101019

6101037 ADDOLCITORE 12LT VOLUMETRICO C/KIT DISINFEZIONE RESINE / VOLUMETRIC WATER-SOFTNER 12LT



6101049 ADDOLCITORE 12LT LOGIX CABINATO 255/740 / VOLUMETRIC WATER-SOFTNER 12LT



6101018 KIT
TESTATA
ADDOLCITORE
6+1FIL. /
WATER-SOFTNER
HEAD KIT 6 +1 FIL.



6101035, 6101061,
6101010, 6101011,
6101036

6101025 SACCO
RESINA
MONOSFERICA LT 25
/ MONOSPHERICAL
RESIN SACK 25 LT



6101019 KIT
MEMBRANE PER
AUT 255 /
MEMBRANE KIT FOR
AUT 255



6101035, 6101061,
6101010, 6101011,
6101036

6101026 BOMBOL
A X ADDOLCITORE
AUTOMATICO 5LT. /
CYLINDER FOR
AUTOMATIC WATER
SOFTNER 5LT



6101071 AIR
CHECK KIT /
AIR CHECK KIT



6101039 DOLCEAC
QUA ANTICALCARE
M1CPI IN SCATOLA
/ DOLCEACQUA



6101022 TRASFOR
MATORE 220V 12V
PER AUTOTROL /
TRANSFORMER
220V 12V FOR
AUTOTROL



6101040 TESTATA
EVERPURE QL3B /
WATER-SOFTNER
HEAD EVERPURE
QL3B



H=63mm

6101065 ADDOLCI
TORE AUTOMATICO
CAB. 5LT
ELETTRONICO
ELECTRONIC
AUTOMATIC WATER
SOFTENER 5LT

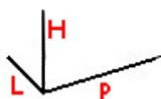

H=420mm, L= 215mm,
P=430mm,
gasket=6101082

6101066 CARTUCC
IA FILTRO MEDIA 4C
BEVERAGE /
FILTER CARTRIDGE
4C EVERPURE

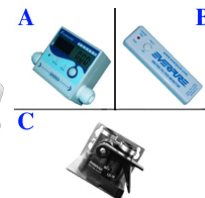

A=6101051,
B=6101052,
C=6101040,
capacity= 11355lt,
H=337mm, Ø=78mm

6101082 KIT
MEMBRANE (VALV.
A DISCO PER 604) /
MEMBRANES KIT x
6101065



6101097 CARTUCC
IA PER SCALEKLEEN
SANITIZING /
CARTRIDGE FOR
SANITIZING
SCALEKLEEN



TESTATA=6101040,
CONFEZIONE
1KG=1143059

6101081 KIT OR
SCARICO E
ENTRATA
ADDOLCITORE
AUTOMATICO /
DRAIN AND INLET
OR SET FOR
AUTOMATIC
WATER-SOFTENER



6101077 FILTRO
DECARBONATTATO
RE PER ACQUA +2
RACCORDI 10-3/8" /
WATERSOFTNERFIL
TER + 2
CONNECTIONS 10-
3/8"



5 KH= 14000lt,
10 KH=7000lt,
15 KH=4660lt,
20 KH= 3500lt,
25KH= 2800lt,
H=400mm,
Øbase=105mm

6101079 CARTUCCIA
BESTMAX 2XL /
CARTRIDGE
BESTMAX 2XL



H=460mm, Ø=180mm,
12000 Lt, =6101056

6101092 CARTUCCIA
CON TESTATA BY
PASS CLARIS ULTRA
170 /
CARTRIDGE WITH
HEAD BYPASS -
CLARIS ULTRA 170



Ø=83mm,
H testata=85mm,
H=213mm

6101051 WATER
METER /
WATER METER



6101090 CARTUCCIA
CON TESTATA BY
PASS CLARIS ULTRA
500 /
CARTRIDGE WITH
HEAD BYPASS -
CLARIS ULTRA 500



Ø=83mm,
H testata=85mm,
H=395mm

6101059 CONTALIT
RI AQUAMETER
WATER+MORE /
WATER METER
WATER+MORE



6101091 CARTUCCIA
CON TESTATA BY-
PASS CLARIS
ULTRA 1000 /
CARTRIDGE WITH
HEAD BYPASS -
CLARIS ULTRA 1000



Ø=130mm,
H testata=85mm,
H=325mm

6101052 FILTER
MONITOR /
FILTER MONITOR



6101056 TESTATA
CARTUCCIA
BESTMAX XL
WATER+MORE /
CARTRIDGE HEAD
BESTMAX XL
WATER+MORE



H=103mm

6101073 CONTALIT
RI ACQUA FREDDA
SECCO 3/4" /
COLD WATER
METER 3/4"

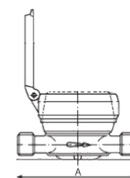

A=130mm

6101055 CARTUCCIA
BESTMAX XL
WATER+MORE /
CARTRIDGE
BESTMAX XL
WATER+MORE



= 6101056

6116003 DOCCETTA
LAVASTOVIGLIE /
DISH-WASHER
SHOWER



6101057 KIT
TESTATA +
CARTUCCIA
BESTMAX XL
WATER+MORE /
CARTRIDGE HEAD +
CARTRIDGE
BESTMAX XL
WATER+MORE



6116017 DOCCIA
PER CUCINA
INDUSTRIALE A
LEVA /
SHOWER FOR
KITCHEN



6116018 DOCCIA
PER CUCINA
MODELLO DELUXE
/
SHOWER FOR
KITCHEN DELUXE



6116031 DOCCET
TA FORNO NERA-
GRIGIA A
PULSANTE /
OVEN SHOWER



6116032 DOCCET
TA FORNO NERA
ACCIAIO /
OVEN SHOWER
R62200133:
LAINOX ALI SPA
LAR62200133:
LAINOX ALI SPA



6116043 RUBINE
TTO A PEDALE PER
SOLO ACQUA
FREDDA /
FOOT OPERATED
TAP COLD WATER
ONLY



6116016 MISCEL
ATORE A PEDALE /
SHOWER MIXER



6116065 RUBINE
TTO MISCELATORE
A PEDALE
SOSPESO TIPO RPR
/
MIXER TAP FOOT
PEDAL SUSPENDED
TYPE RPR



6116021 RUBINE
TTO MISCELATORE
A PEDALE ECO
C/LEVA BLOC.
CROMATO /
SHOWER MIXER
COCK



6116042 RUBINE
TTO MISCELATORE
A PEDALE RPR CON
DOPPIA LEVA DI
COMAND /
FOOT OPERATED
MIXER TAP WITH
TWO LEVERS
CONTROL



6116007 MISCEL
ATORE MONOFORO
C/LEVA CLINICA
NERA 1/2" L 250MM
/
MONO HOLE MIXER
WITH CLINICAL
LEVER



H Leva aperta= 470mm,
H Leva chiusa= 370mm

6116006 RUB.
BIFORO MONOC.
ATT. DOCCIA DA
1/2" BOCCAF. /
TWO HOLES
SINGLE LEVER
MIXER TAP WITH
CAST OUTLET
ATTACHMENT TO
SHOWER UNITS
1/2"



6116025 RUBINE
TTO MISCELATORE
BIFORO
MONOCOMANDO
C/LEVA NERA /
2 HOLE MIXER
WITH CLINICAL
LEVER



6116054 RUB.
MISCELATORE
BIFORO
MONOCOMANDO A
MURO BOCCAFUSA
DA MM.250 /
TWO HOLES LEVER
MIXER TAP WALL



6116055 RUB.
MISCELATORE
BIFORO MONOC. A
MURO ATT.
DOCCIA
BOCCAFUSA /
TWO HOLES LEVER
MIXER TAP WALL



6116059 RUBINE
TTO BIFORO
MONOCOMANDO A
MURO LEVA
LUNGA CANNA S M
/
WALL-MOUNTED
TWO HOLE TAP ø
3/4"



S&P Cooking Catalogue 2017

6116009 MONOC.
LAVELLO
PERFECTA L.C.
CROMATO /
MONOHOLE MIXER
WITH CLINICAL
LEVER PERFECTA



6116019 RUBINE
TTO MISC.BIFORO
DA BANCO COM 1/4
GIRO CANNA
ATT.1/2"
/ 2 HOLE MIXER
HAHN



6116033 MISCEL
ATORE MONOFORO
C/DOCCIA
ESTRAIBILE 1/2"F /
"MONOHOLE
MIXER WITH
EXTRACTABLE
SHOWER 1/2""F"



6116024 MISCEL
ATORE MONOFORO
MONOCOMANDO
ATTACCO 3/8"F /
"MONOHOLE
MIXER 3/8""F"



6116030 MISCEL
ATORE 2 VIE
ACCIAIO INOX 304 /
SHOWER MIXER 2
WAY STEINLESS
STEEL 304



6116058 GRUPPO
DOCCIA MIGNON
H.600 COLORE
NERO /
MIGNON PRE-
WASHING KIT H600



6116027 RUBINE
TTO MISCELATORE
MONOFORO LEVA
CORTA 3/8" /
"MONOHOLE
MIXER WITH
CLINICAL LEVER
3/8""



6116026 GRUPPO
DOCCIA NERO
mm1200 /
BLACK
MONOHOLE MIXER
WITH SHOWER
1200mm



6116047 RUBINE
TTO MISC. MONOF.
COMANDI 1/4 DI
GIRO PER
ATTACCO GRUPP /
MONOBLOCK
MIXER TAP WITH
1/4 TURN HANDLE



6116020 GRUPPO
DOCCIA TOP
CLASS COLORE
NERO CON
RUBINETTO /
BLACK
MONOHOLE MIXER
WITH SHOWER
STAR



6116067 RUBINE
TTO
MISCELEATORE
MONOFORO RDF
COMANDI A
CROCE S/CANNA
ATT /
MONOHOLE MIXER
RDF



6116036 GRUPPO
DOCCIA JOLLY
COMPLETO DI
MISCELATORE /
SHOWER JOLLY
WITH MIXER



6116046 RUBINE
TTO MISCELATORE
BIFORO DA BANCO
CANNA 300MM /
TWO HOLES MIXER
TAP WITH
DIAMETER 300mm



6116005 MISCEL
ATORE
MONOF.NERO
C/DOCCIA CANNA
250MM H DOCCIA
1200MM /
BLUE MONOHOLE
MIXER WITH
SHOWER



6116062 GRUPPO
DOCCIA
C/MISCELATORE
MONOFORO LEVA
CLINICA CANNA
250MM DOCCIA
1200MM /
SHOWER WITH
MIXER TAP HOLE -
CLINIC LEVER -
BARREL SHOWER
250MM 1200MM



6116011 CARTUC
CIA RUBINETTO
L/CLNC /
CARTRIDGE FOR
COCK L/CLNC

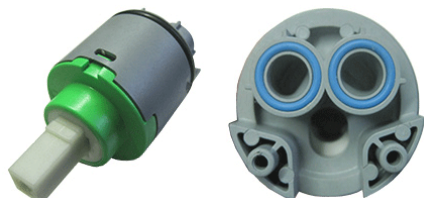

6116028 EROGAT
ORE GIREVOLE
CON CANNA
SNODABILE TIPO
JOTA /
SHOWER TYPE
JOTA



6116037 CANNA
MISCELATORE
DOCCIONE /
SHOWER MIXER
PIPE



6116052 EROGAT
ORE SNODABILE
BASETTA CONICA
CANNA U DA
MM.250 /
U TYPE ROTATING
SPOUT WITH
CONICAL BASE
250mm



HOLES FOR
FIXING=21mm

6116015 CANNA
ALLUNGABILE
20/40 /
EXTENSIBLE PIPE
FOR WATER TAP
20/40



6116035 CANNA
GIREVOLE
RUBINETTO PER
COLONNINA /
TAP ROTARY PIPE
36100808:
MARENO
INDUSTRIE ALI
SPA



6116063 "RUBINE
TTO VERTICALE
ECO 1/4 DI GIRO
CANNA U MM.200
ATT. DA 1/2" / "
TAP VERTICAL
ECO 1/4 TURN
CANE U mm.200
ATT. 1/2" "



6116039 COLONNI
NA ORIENTABILE H
700MM /
ADJUSTABLE
COLUMN H 700MM



6116050 LEVA
CLINICA MM. 310
COLORE NERO /
BLACK CLINIC
LEVER 310mm



6116066 KIT
CARTUCCIA
MISCELATORE +
LEVA /
KIT CARTRIDGE +
LEVER



6116069 CARTUC
CIA CX42 PER RUB.
MONOCOMANDO
ATTACCO 9x9 /
CARTRIDGE CX42
FOR MIXER 9X9



6116045 CARTUC
CIA RIALZATA PER
RUBINETTI
MONOCOMANDO
EURO CON
ATTACC /
CARTRIGE

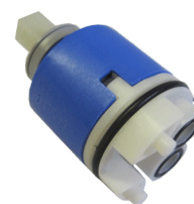

6116022 AERREAT
ORE M 24 /
STOP JET TAP M 24



S&P Cooking Catalogue 2017

6116023 AEREA
TTO F 22 /
STOP JET TAP F 22



6116029 RUBINE
TTO ACQUA
DEPURATA /
PURIFIED WATER
SHOWER

R0223:

EURO TECHNO
FLUID S.R.L



6116049 MOLLON
E DI
BILANCIAMENTO
SILVER CON
PROTEZIONE
COLORE NERO /
SILVER SPRING
WITH BLACK
PLASTIC
PROTECTION



6116070 "VITONE
1/2" 1/4 DI GIRO
ACQUA FREDDA
ATT. BROCCIA
8x20" /
COLD WATER
JOINT 8X20"

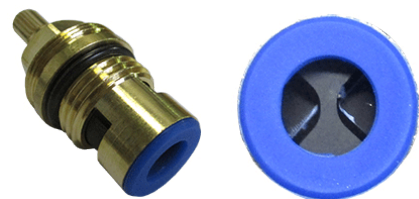

1124007 ELETTRO
VALVOLA 1 VIA 90°
D.10,5 /
SOLENOID VALVE 1
WAY 90° D. 10,5

RF00A581:

EURFRIGOR SRL

394:

ARISTARCO
KASTEL SPA

120145:

COMENDA ALI SPA

AL10, AL20, AL03,
AL54, AL55, AF73,
AF88: A.T.A. SRL

240006:

ELETTROBAR
DIVISIONE DELLA
EUROTEC SRL

1037308800:

MARENO
INDUSTRIE ALI
SPA

DEV3S: COLGED

12095427:

FAGOR
INDUSTRIALE
S.R.L.

B100,B303,CF35,CF4

O: ADLER S.P.A.



3306510: LASA SRL

926035:

BRICE ITALIA SRL

RF00A581:

EURFRIGOR ICE

MAKERS SRL

1124151 ELETTRO
VALVOLA 1V-
90°220/240 161mm /
SOLENOID VALVE 1
WAY 90° 220/240
161mm



1124363 ELETTRO
VALVOLA 1 VIA 220V
90° D.10,5 BASSA
TEMPERATURA /
SOLENOID VALVE 1
WAY 90° D. 10,5 230V
LOW TEMPERATURE



1124064 ELETTRO
VALVOLA 1 VIA 90°
D.10,5 24V /
SOLENOID VALVE 1
WAY 90° D. 10,5 24V

OL0175:

ELECTROLUX
PROFESSIONAL
S.P.A.

0H2513:

ELECTROLUX
PROFESSIONAL
S.P.A.



1124030 ELETTRO
VALVOLA 1 VIA 90°
D.13,5 /
SOLENOID VALVE 1
WAY 90° D. 13,5



1124155 ELETTRO
VALVOLA ELBI 1VIA
90° 230V 13,5 /
SOLENOID VALVE 1
WAY 90° 230V D.13,5
ELBI



1124086 ELETTRO
VALVOLA 1 VIA D.
13,5 90° 24V /
SOLENOID VALVE 1
WAY D. 13,5 90° 24V



1124111 ELETTRO
VALVOLA 1 VIA 90°
D.13,5 24V /
SOLENOID VALVE 1
WAY 90° D. 13,5 24V



1124009 ELETTRO
VALVOLA 2 VIE 90°
D. 10,5 /
SOLENOID VALVE 2
WAYS 90° D. 10,5

RF000625:

EURFRIGOR SRL

AL54D, AL55D,

AF61, AF78, AL16,

AL26, AL05,

AL40/46/05-D:

A.T.A. SRL

120917:

COMENDA ALI SPA

120142:

COMENDA ALI SPA

AL30, AL40, AL35,

AL45, AL50, AL60,

AL11, AL21, AL15,

AL25; A.T.A. SRL

B100, B303, CF35,

CF40: ADLER S.P.A.

RF000625:

BRICE ITALIA SRL



1124365 ELETTRO
VALVOLA DUE VIE
230V 90° D.10,5
BASSA
TEMPERATURA /
SOLENOID VALVE 2
WAYS 90° D. 10,5
230V LOW
TEMPERATURE



1124066 ELETTRO
V. 2 VIE 90° D.10,5
24V /
SOLENOID VALVE 2
WAYS 90° D. 10,5 24V

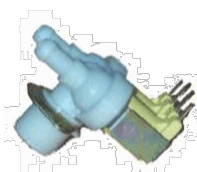

1124033 ELETTRO
VALVOLA 2 VIE 90°
D. 13,5 /
SOLENOID VALVE 2
WAYS 90° D. 13,5



1124154 ELETTRO
VALVOLA 2VIE 90°
230V D.13,5 ELBI /
SOLENOID VALVE 2
WAYS 90° 230V D.13,5
ELBI



1124036 ELETTRO
VALVOLA 1 VIA 180°
D.10,5 /
SOLENOID VALVE 1
WAY 180° D. 10,5

843101: TEIKOS SRL

240016:

ELETTROBAR

DIVISIONE DELLA

EUROTEC SRL

240011:

ELETTROBAR

DIVISIONE DELLA

EUROTEC SRL

*:

MBM- EUROTEC SRL

- DIV. COOKING

SERVICE

CEEV1:

OMNIWASH SRL

2709000:

MARENO

INDUSTRIE ALI

SPA

34040022:

RANCILIO SPA

902390:

SILANOS SRL

4267: MACH

REB240011: COLGED

CF35,CF40:

ADLER S.P.A.

D240011:

GIGA GRANDI

CUCINE SRL

R65110010:

LAINOX ALI SPA

DW10703:

DIHR-ALI SPA

50102860:

LAINOX ALI SPA

26629:

HOONVED - ALI

SPA

0300025:

LAMBER SRL

23120021:

ELFRAMO SPA

120173:

COMENDA ALI SPA

120173:

HOONVED - ALI

SPA

LAR65110010:

LAINOX ALI SPA

MA2709000:

SILKO ALI SPA

MA2709000:

MARENO

INDUSTRIE ALI

SPA

12025161:

FAGOR

INDUSTRIALE

S.R.L.



1124364 ELETTRO
VALVOLA 1 VIA 220V
180° D. 10.5 BASSA
TEMPERATURA /
SOLENOID VALVE 1
WAY 180° D. 10,5
230V LOW
TEMPERATURE
103370:
KRUPPS S.R.L.



1124063 ELETTRO
V. 1 VIA 180° D.10,5
24V /
SOLENOID VALVE 1
WAY 180° D. 10,5 24V
*: OMNIWASH SRL
- SOCIETA' A
SOCIO UNICO

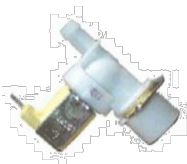

1124031 ELETTRO
VALVOLA 1 VIA 180°
D.13,5 /
SOLENOID VALVE 1
WAY 180° D. 13,5
DW30001000:
DIHR-ALI SPA
3106180: .
WINTERHALTER
ITALIA SRL



1124172 ELETTRO
VALVOLA 1 VIA 180°
230V D.13,5 ELBI /
SOLENOID VALVE 1
WAY 180° 230V D.13,5
ELBI



1124168 ELETTRO
VALVOLA DOPPIA
180° D.10.5 ELBI 230V
/
SOLENOID VALVE 2
WAYS 180° D.10,5
ELBI 230V
9041010:
GRUPPO CIMBALI
SPA
977092000:
GRUPPO CIMBALI
SPA



1124008 ELETTRO
VALVOLA 2 VIE 180°
D.10,5 /
SOLENOID VALVE 2
WAYS 180° D. 10,5
120146:
COMENDA ALI SPA
843103:
TEIKOS SRL
*: MBM- EUROTEC
SRL - DIV.
COOKING SERVICE
240003:
ELETTROBAR
DIVISIONE DELLA
EUROTEC SRL



34040021:
RANCILIO SPA
CEEV2:
OMNIWASH SRL -
SOCIETA' A SOCIO
UNICO
902400:
SILANOS SRL
DEV3D: COLGED
1573: MACH
DW15098:
DIHR-ALI SPA
26631:
HOONVED - ALI
SPA
D240003:
GIGA GRANDI
CUCINE SRL
3300500: LASA SRL
03000056:
LAMBER SRL
23120001:
ELFRAMO SPA
R65110040-R65115:
LAINOX ALI SPA
049230:
ELECTROLUX
PROFESSIONAL
S.P.A.
929172:
ELETTROBAR
DIVISIONE DELLA
EUROTEC SRL
425311034:
GICO SPA

1124366 ELETTRO
VALVOLA 2 VIE 230V
180° D.10.5 BASSA
TEMPERATURA /
SOLENOID VALVE 2
WAYS 180° D. 10,5
230V LOW
TEMPERATURE



1124065 ELETTRO
VALVOLA 2 VIE 180°
D.10,5 24V /
SOLENOID VALVE 2
WAYS 180° D. 10,5
24V



1124032 ELETTRO
VALVOLA 2 VIE 180°
D.13,5 /
SOLENOID VALVE 2
WAYS 180° D. 13,5
DW3000101:
DIHR-ALI SPA
3106182:
WINTERHALTER
ITALIA SRL



1124210 ELETTRICO
VALVOLA 2 VIE 180°
D.13,5 ELBI /
SOLENOID VALVE 2
WAYS 180° D.13,5
ELBI



1124099 ELETTRICO
VALVOLA 3 VIE 90°
D. 10,5 /
SOLENOID VALVE 3
WAYS 90° D. 10,5

AL31, AL42, AL36,
AL46, AL16, AL26,
AF61DPS, AF78DPS:
A.T.A. SRL
120179:
COMENDA ALI SPA
26632:
HOONVED - ALI
SPA



1124035 ELETTRICO
VALVOLA 3 VIE 90°
D.13,5 /
SOLENOID VALVE 3
WAYS 90° D. 13,5



1124010 ELETTRICO
VALVOLA 3 VIE 180°
D. 10,5 /
SOLENOID VALVE 3
WAYS 180° D. 10,5

34040020:
RANCILIO SPA
902410:
SILANOS SRL
CEEV3:
OMNIWASH SRL -
SOCIETA' A SOCIO
UNICO
DEV3T: COLGED
1195: MACH
18010079:
NUOVA SIMONELLI
SPA
DW15099:
DIHR-ALI SPA
3305000: LASA SRL
120175:
COMENDA ALI SPA



1124034 ELETTRICO
VALVOLA 3 VIE 180°
D.13,5 /
SOLENOID VALVE 3
WAYS 180° D. 13,5



1124301 ELETTRICO
VALVOLA 2 VIE 220V
50HZ C/REG. PORT. /
SOLENOID VALVE 2
WAYS STRAIGHT
220V 50HZ

R65110230:
LAINOX ALI SPA
LAR65110230:
OLIS DIVISIONE
DI ALI GROUP SPA -
LAR65110230:
LAINOX ALI SPA



1124247 ELETTRICO
VALVOLA
CUOCIPASTA
MARENO N.T. /
SOLENOID VALVE
MARENO
CR0586050:
SILKO ALI SPA
CR0586050:
MARENO
INDUSTRIE ALI
SPA



1124336 ELETTRICO
VALVOLA 2 VIE /
SOLENOID VALVE
2WAY



1124098 BOBINA
ELETTRICOVALVOLA
LT 220V /
SOLENOID VALVE
COIL LT 220V
630969:
COMENDA ALI SPA

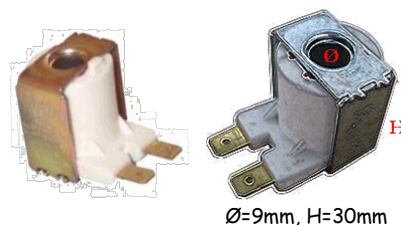

Ø=9mm, H=30mm

1124367 BOBINA
FREDDA AZZURRA
230V /
COLD COIL BLUE

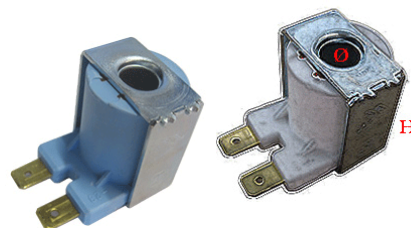

Ø=9mm, H=30mm

1124069 BOBINA
ELETTRICOVALVOLA
24V AC /
SOLENOID VALVE
COIL 24V AC

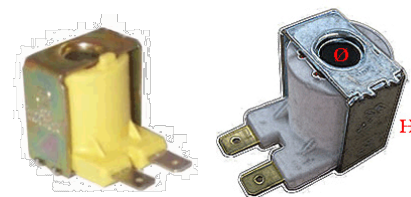

Ø=9mm, H=30mm

S&P Cooking Catalogue 2017

1124150 BOBINA
24V AC /
COIL 24V AC

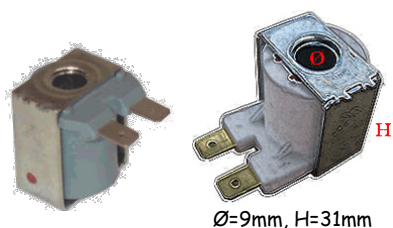

Ø=9mm, H=31mm

1124192 BOBINA
24V CC /
SOLENOID VALVE
COIL 24V CC

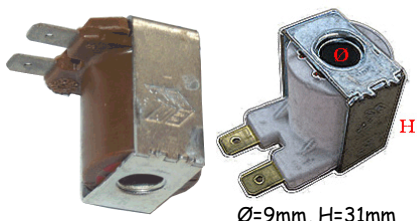

Ø=9mm, H=31mm

1124071 REGOLAT
ORE USCITA 0,25L.
ROSSO /
RED DEBIT
REGULATOR 0,25L.
ZIID002:
SIMAG SPA
RTFOC00120:
MBM- EUROTEC SRL
- DIV. COOKING
SERVICE



1124176 RIDUTTOR
E FLUSSO 0,25 L/MIN
VERDE ELBI /
GREEN DEBIT
REGULATOR
0,25LT/MIN ELBI



1124073 REGOLAT
ORE USCITA 0,5L.
ARANCIO /
ORANGE DEBIT
REGULATOR 0,5L.
10558: ADLER S.P.A.
401200500:
STAFF ICE SYSTEM
SRL
4167-3306500:
LASA SRL

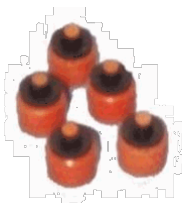

1124072 REGOLAT
ORE USCITA 1,2L.
MARRONE /
BROWN DEBIT
REGULATOR 1,2L.
4012006000:
STAFF ICE SYSTEM
SRL
65010520:
SCOTSMAN ICE
SRL
*:
MBM- EUROTEC SRL
- DIV. COOKING
SERVICE



1124074 REGOLAT
ORE USCITA 2,5L.
GIALLO /
YELLOW DEBIT
REGULATOR 2,5L.
*:

MBM- EUROTEC SRL
- DIV. COOKING
SERVICE
RF000702:
EURFRIGOR ICE
MAKERS SRL
4012008000:
STAFF ICE SYSTEM
SRL
65010521:
SCOTSMAN ICE SRL
172833:
MBM- EUROTEC SRL
- DIV. COOKING
SERVICE



1124075 REGOLAT
ORE USCITA 3L.
VERDE /
GREEN DEBIT
REGULATOR 3L.

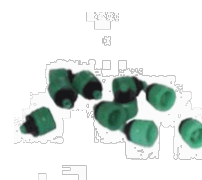

1124076 REGOLAT
ORE USCITA 5L.
NERO /
BLACK DEBIT
REGULATOR 5L.
Z1CW022:
SIMAG SPA
650100522:
SCOTSMAN ICE SRL

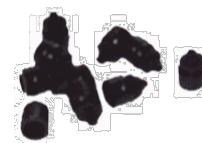

1124209 RIDUTTOR
E DI PORTATA IN
USCITA 5,5 LT/MIN /
DEBIT REGULATOR
5,5 LT/MIN



1124011 ELETTRO
VALVOLA LUCIFER 2
VIE F1/8-F1/8 220V /
SOLENOID VALVE
LUCIFER 2 WAYS
RALS
34040002:
RANCILIO SPA
180015:
MAGISTER
SISTEMA CAFFE'
SRL
533798310:
FAEMA
11:
LA SPAZIALE SPA



BOBINA=1124045

1124078 ELETTRO
V. 2 VIE 1/8" 220V
RALS /
2 WAYS VALEV 1/8"
220V RALS



1124018 EL.VAL. 2
VIE 3/8" ACQUA 220V
/
"WATER SOLENOID
VALVE 2 WAYS 3/8"
220V"



1124051 ELETTRO
V.PARKER 2 VIE 1/4 /
SOLENOID VALVE
PARKER 2 WAYS 1/4
533895800: FAEMA
1124051:
SAN MARCO
06478:
LA SPAZIALE SPA



BOBINA=1124180

1124019 EL.VAL.
1/2" ACQUA 220V
50HZ /
"WATER SOLENOID
VALVE 1/2" 220V
50HZ"
120174:
COMENDA ALI SPA
120174:
HOONVED - ALI
SPA



1124090 ELETTRO
VALVOLA 2 VIE 1/4"
VITON 220 /
"SOLENOID VALVE 2
WAYS 1/4" VITON
220"



1124041 ELETTRO
V. 1/2" ACQUA 220V
BG /



"WATER SOLENOID
VALVE 1/2" 220V
BG"

1124005 ELETTRO
V. LUCIFER 1/8 24V
2V /
SOLENOID VALVE
PARKER 1/8 24V 2V



BOBINA=1124102

1124085 ELETTRO
VALVOLA L140
FF1/2" 230V /
"SOLENOID VALVE
L140 FF1/2" 230V"
23140006*:
ELFRAMO SPA



1124017 EL.VAL. 2
VIE ACQUA 1/4" 220V
/
"WATER SOLENOID
VALVE 2 WAYS 1/4"
220V"



1124023 EL.VAL. 2
VIE 1/2" VAP/ACQUA
24V /
"STEAM/WATER
SOLENOID VALVE 2
WAYS 1/2" 24V"
23140004:
ELFRAMO SPA

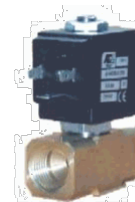

1124022 EL.VAL. 2
VIE 1/4" VAP/ACQUA
24 / "
STEAM/WATER
SOLENOID VALVE 2
WAYS 1/4" 24"



1124026 EL.VAL.
1/2" VAP/ACQUA
220V /
"STEAM/WATER
SOLENOID VALVE
1/2" 220V"



1124024 EL.VAL.
1/4" VAP/ACQUA
220V /
"STEAM/WATER
SOLENOID VALVE
1/4" 220V"



1124108 EL.VAL. 2
VIE 1/2" VAP/ACQUA
220V APERTA /
"STEAM/WATER
SOLENOID VALVE 2
WAYS 1/2" 220V"



1124025 EL. VAL. 2
VIE 1/2" VAP/ACQUA
220V /
"STEAM/WATER
SOLENOID VALVE 2
WAYS 1/2"" 220V"
23140006:
ELFRAMO SPA



1124020 EL. VAL.
3/4" ACQUA 220V
50HZ /
"WATER SOLENOID
VALVE 3/4"" 220V
50HZ"
120158:
COMENDA ALI SPA



1124341 "ELETTRICO
VALVOLA X ACQUA
NC 3/4""
PRESS. DIFF. 0,15/13BAR
R" 24V AC /
SOLENOID VALVE
FOR WATER NC 3/4"
".0,15 / 13BAR" 24V
AC



1124021 EL. VAL.
1" ACQUA/GAS 220V
50-60 /
"WATER/GAS
SOLENOID VALVE
1"" 220V 50-60"



1124027 EL. VAL. 2
VIE 1/4" GAS 220V /
"GAS SOLENOID
VALVE 2 WAYS 1/4""
220V"



1124028 EL. VAL. 2
VIE 1/2" GAS 220V /
"GAS SOLENOID
VALVE 2 WAYS 1/2""
220V"



1124029 EL. VAL. 2
VIE 3/4" GAS 220V /
"GAS SOLENOID
VALVE 2 WAYS 3/4""
220V"



1124312 ELETTRICO
VALVOLA SCARICO
ARIA LINEA 46 /
DRAIN VALVE



1124049 ELETTRICO
V. VAPORE 1"1/4 180°
C /
"STEAM SOLENOID
VALVE 1"1/4 180°C"



1124103 ELETTRICO
VALVOLA GAS NC
D. 1/2" /
"GAS SOLENOID
VALVE NC D. 1/2""



1124104 ELETTRICO
VALVOLA GAS NC D.
3/4" /
"GAS SOLENOID
VALVE NC D. 3/4""



1124067 ELETTRICO
V. GAS RIARMO MAN.
D. 1/2" /
MANUAL
REARMAMENT GAS
SOLENOID VALVE D.
1/2"



1124068 ELETTRICO
V. GAS RIARMO
MAN. 3/4" /
MANUAL
REARMAMENT GAS
SOLENOID VALVE
3/4"



1124310 ELETTRICO
V. 1 VIA
B. PRESS. F. GAS /
SOLENOID VALVE 1
WAY LOW
PRESSURE. GAS

EB01800:
OEM ALI SPA



1124340 ELETTRICO
VALVOLA 084013 /
SOLENOID VALVE
084013

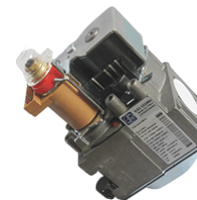

1124055 BOBINA X
ELETTRORVALVOLA
20/E 220V 50Hz /
SOLENOID VALVE
COIL 20/E

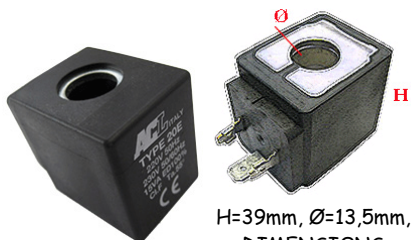

H=39mm, Ø=13,5mm,
DIMENSIONS
30X42mm

1124058 BOBINA X
ELETTRORVALVOLA
22/B 24V 50-60Hz /
SOLENOID VALVE
COIL 22/B

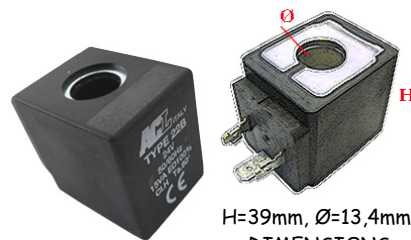

H=39mm, Ø=13,4mm,
DIMENSIONS
30X42mm

1124059 BOBINA X
ELETTRORVALVOLA
22/E 220V 50Hz /
SOLENOID VALVE
COIL 22/E

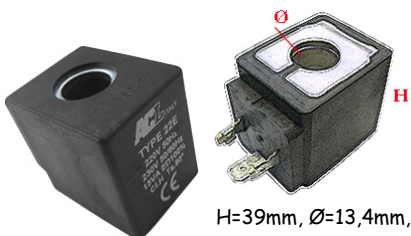

H=39mm, Ø=13,4mm,
DIMENSIONS
30X42mm

1124193 BOBINA
24V 30B / .
SOLENOID VALVE
COIL 24V 30B



1124218 BOBINA
TIPO 30/B 24V AC
(ALTERNATA) 50-
60Hz /
SOLENOID VALVE
COIL 30/E 24V DC

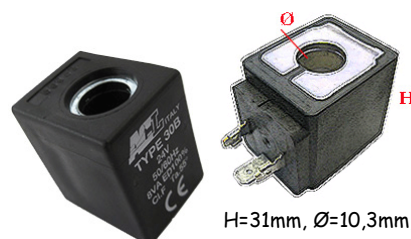

H=31mm, Ø=10,3mm,
DIMENSIONS
22X27mm

1124056 BOBINA X
ELETTRORVALVOLA
30/E 230V 50-60Hz /
SOLENOID VALVE
COIL 30/E

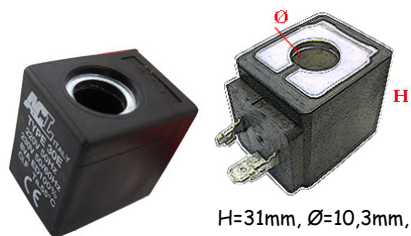

H=31mm, Ø=10,3mm,
DIMENSIONS
22X27mm

1124317 BOBINA
32B 24V AC 50-60Hz /
32B 24V AC COIL

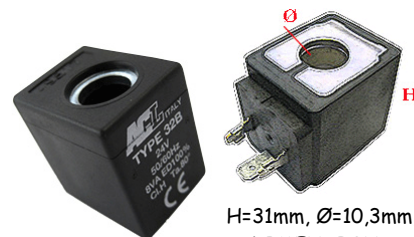

H=31mm, Ø=10,3mm,
DIMENSIONS
22X27mm

1124060 BOBINA X
ELETTRORVALVOLA
32/E /
SOLENOID VALVE
COIL 32/E

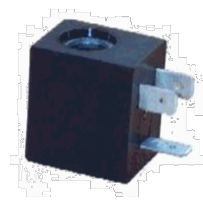

1124061 BOBINA X
ELETTRORVALVOLA
40/E 220V 50Hz /
SOLENOID VALVE
COIL 40/E

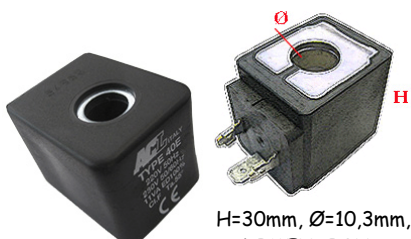

H=30mm, Ø=10,3mm,
DIMENSIONS
30X38mm

1124057 BOBINA X
ELETTRORVALVOLA
221 24V= 10W /
SOLENOID VALVE
COIL 221

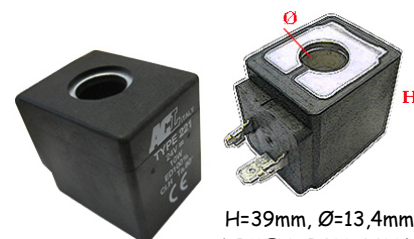

H=39mm, Ø=13,4mm,
DIMENSION=30X42
mm

1124039 BOBINA
ELETTRORVALVOLA
20/B 24V 50HZ /
SOLENOID VALVE
COIL 24V 50HZ

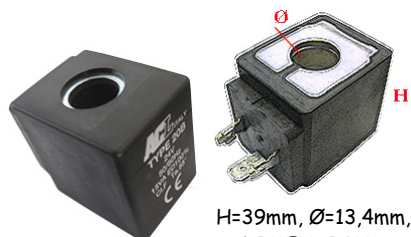

H=39mm, Ø=13,4mm,
DIMENSIONS
30X42mm

1124271 BOBINA X
EV 301 24V= DC 6,5W
/
SOLENOID VALVE
COIL 24V DC

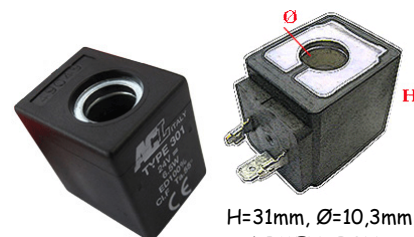

H=31mm, Ø=10,3mm,
DIMENSIONS
22X27mm

1124087 BOBINA
V.48/50-60 E2A
NYLON 20/C /
COIL V48/50-60 E2A
NYLON

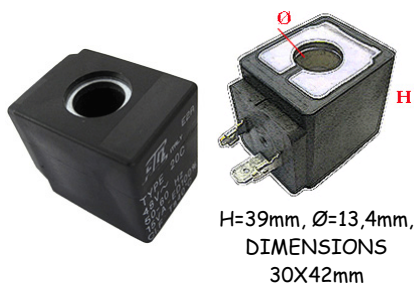

H=39mm, Ø=13,4mm,
DIMENSIONS
30X42mm

1124374 BOBINA
NOVA EV 2 220V 60
Hz (completa di viti) /
COIL NOVA EV 2
220V 60 Hz (with
screw)

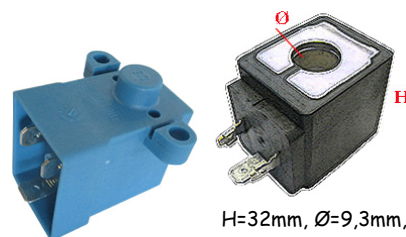

H=32mm, Ø=9,3mm,
DIMENSIONS
25X37mm

12018720:

FAGOR
INDUSTRIALE
S.R.L.

1124062 BOBINA X
ELETTROVALVOLA
52/G 380V 50-60Hz /
SOLENOID VALVE
COIL 52/G

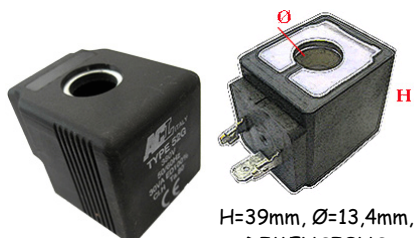

H=39mm, Ø=13,4mm,
DIMENSIONS
36X48mm

1124100 BOBINA
EV1 822/827/828-
220/240V 50Hz /
COIL EV1 822/827/828-
220/240V

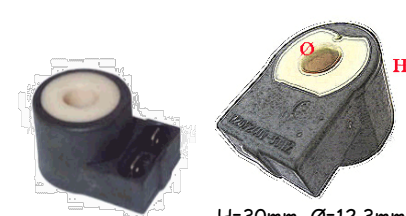

H=30mm, Ø=12,3mm,
DIMENSIONS
34X50mm

0967128: SIT

1124038 BOBINA
EL.VAL. 380V 50HZ /
SOLENOID VALVE
COIL 380V 50HZ



1124148 BOBINA
NC 220V /
SOLENOID VALVE
COIL 220V

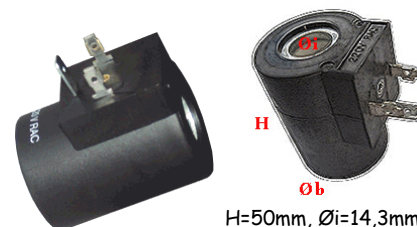

H=50mm, Øi=14,3mm,
Øb=36mm

1124080 CONNETT
ORE RETTANG. X
SERIE 30 /
RECTANGULAR
CONNECTOR FOR
SET 30



BOBINA=1124093

1124094 BOBINA
220V TANDEM /
COIL 220V TANDEM
967090: SIT



1124081 CONNETT
ORE QUADRATO X
SERIE 30 /
SQUARE
CONNECTOR FOR
SET 30

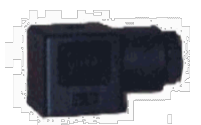

1124281 BOBINA
220/240V ORIENTATA
ALTO /
SOLENOID VALVE
COIL 220/240V
0967066: SIT



H=40mm, Ø=9,3mm,
DIMENSIONS
25X47mm

1124093 BOBINA
220V 820 NOVA /
COIL 220V 820 NOVA
0967064: SIT

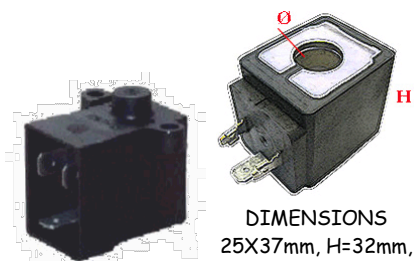

DIMENSIONS
25X37mm, H=32mm,
Ø=9,3mm,
CONNETTORE=
1124080

3126281 FILTRO
PENTOLA COMP. /
DRAIN FILTER
BOILING POT
30Q0450:

ANGELO PO
GRANDI CUCINE
SPA



S&P Cooking Catalogue 2017

3126306 ANTIDISTURBO RC 047/220
400V /
ANTI-DISTURB
FILTER RC 047/220
400V
EN07300:
OEM ALI SPA



3126157 FILTRO
PER GPL PN16 1/2"MF
/
"FILTER FOR GPL
PN16 1/2"MF"



3126304 FILTRO
92X92 X ES278
F.TUNNEL /
FILTER 92X92 FOR
ES278
ES27900:
OEM ALI SPA

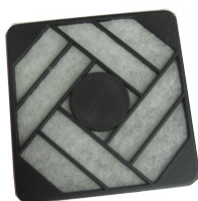

3126322 COMPLETIFILTRO PJ
14/8+96+99+109 /
COMPLETE FILTER PJ
14/8 +96 +99 +109
ACW2520:
OEM ALI SPA

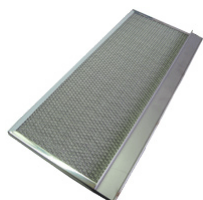

3126348 R72506400
0 FILTRO** /
R725064000 FILTER **
12018840:
FAGOR
INDUSTRIALE
S.R.L.



3126356 GRIGLIA
FILTRO OLIO VASCA
GF15S EX 433009 /
GRID FILTER OIL
TANK GF15S EX 433
009
433009ex:
MBM- EUROTEC SRL
- DIV. COOKING
SERVICE
161746:
MBM- EUROTEC
SRL - DIV.
COOKING SERVICE

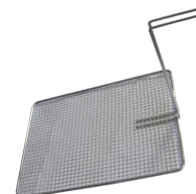

TUBI FLEX INOX / STAINLESS STEEL FLEX PIPES



CODICE S&P S&P CODE	DIMENSIONI DIMENSIONS	TIPO TYPE
2110056	FC-F 3/4 L=1000mm	B PIANO B FLAT
2110050	FC-F 3/4 L=1500mm	B PIANO B FLAT
2110147	FC-F 3/4 L=2000mm	B PIANO B FLAT

CODICE S&P S&P CODE	DIMENSIONI DIMENSIONS
2110045	F 3/8 PIANO/PLANE - M 1/2 L=1500mm



CODICE S&P S&P CODE	DIMENSIONI DIMENSIONS	CODICE S&P S&P CODE	DIMENSIONI DIMENSIONS
2110107	FF 1/2 L=1000mm PIANO - FLAT	2110105	FF 1/2 L=2000mm PIANO - FLAT
2110108	FF 1/2 L=1200mm PIANO - FLAT	2110180	FF 1/2 L=8500mm PIANO - FLAT
2110035	FF 1/2 L=1500mm PIANO - FLAT	2110179	FF 1/2 L=16000mm PIANO - FLAT

TUBI DI CARICO / LOAD PIPES



CODICE S&P S&P CODE	DIMENSIONI DIMENSIONS	TIPO TYPE	CODICE S&P S&P CODE	DIMENSIONI DIMENSIONS	TIPO TYPE
2110030	FC-F 3/4 L=1200mm	A PIANO A FLAT	2110033	FC-F 3/4 L=2000mm	C PIANO / C FLAT ACQUA CALDA / HOT WATER
2110008	FC-F 3/4 L=1500mm	B PIANO B FLAT	2110040	FC-F 3/4 L=2000mm	B PIANO B FLAT
2110169	FC-F 3/4 L=1500mm	C PIANO / C FLAT ACQUA CALDA / HOT WATER	2110041	FC-F 3/4 L=3000mm	B PIANO B FLAT



SPIRALATO
SPIRALLED

VENDITA AL METRO
SELLING AT METER

CODICE S&P S&P CODE	DIMENSIONI DIMENSIONS	CODICE S&P S&P CODE	DIMENSIONI DIMENSIONS
2110185	Ø=12mm	2109025	Ø=18mm
2110003	Ø=14mm	2110082	Ø=20mm
2109024	Ø=16mm		

TUBI / PIPES



**GOMMA
RUBBER**

**VENDITA AL METRO
SELLING AT METER**

CODICE S&P S&P CODE	DIMENSIONI DIMENSIONS	COLORE COLOR	CODICE S&P S&P CODE	DIMENSIONI DIMENSIONS	COLORE COLOR
2110001	Ø=8X17mm	NERO - BLACK FOOD QUALITY	2110002	Ø=10X17mm	NERO BLACK
2109005	Ø=10X17mm	NERO - BLACK FOOD QUALITY			

2110059 SCAMBIA
TORE 003881 /
EXCHANGER 003881
003881:
**ELECTROLUX
PROFESSIONAL
S.P.A.**



7102021 LAMA
AFFETTATRICE 195-
30-3-155 /
BLADE 195-30-3-155

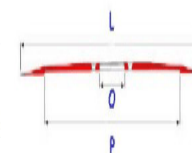
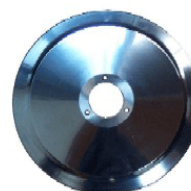

O= 30mm, P= 155mm,
L=195mm h=13mm,
3Fori/Holes,3Trous/
orificios, 3Löcher

2110213 TUBO
SUPERFLEX
TRASP.PU L/R 50 /
TUBE SUPERFLEX PU
L/R 50
GA30800:
OEM ALI SPA



L=1000mm

7102010 LAMA
220-40-3-180 /
BLADE 220-40-3-180

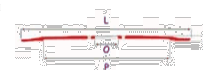

O= 40mm, P= 180mm,
L=220mm, h=15,5mm,
3Fori/Holes,3Trous/
Orificios, 3 Löcher

2110133 FLESSIBIL
E GPL 2 DADI SX
50CM /
GPL FLEX PIPE 2
NUTS LEFT 50CM



2110166 FLESS.GA
S 1/2"FF L=1000MM
UNI EN14800 /
FLEXIBLE GAS HOSE
1/2"FF L=1000MM UNI
EN14800

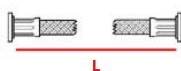

F1/2-F1/2,
L=1000mm

7102004 LAMA
250-40-3 /
BLADE 250-40-3

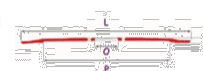

O= 40mm, P= 210mm,
L=250mm, h= 17,5mm,
3Fori/Holes,
3Tros/Orificios,
3 Löcher

2110163 "FLESS.GA
S 1/2""FF L=2000MM
UNI EN14800" /
"GAS HOSE 1/2""FF
L=2000MM UNI
EN14800""

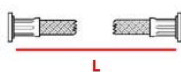

F1/2-F1/2,
L=2000mm

7102015 LAMA
275-40-218-3 FORI /
BLADE 275-40-218-3
HOLES

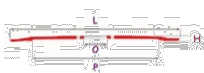
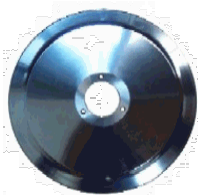

O= 40mm, P= 218mm,
L=275mm, h=22,5,
3Fori/Holes, 3Trous/
orificios, 3 Löcher

7102018 LAMA
SPECIALE 250 SPG
CON GRADINO /
SPECIAL BLADE 250
SPG WITH STEP

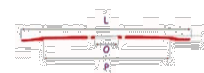

O=40mm, P=200mm,
L=250mm,
3Fori/Holes,
3Trous/Orificios,
3 Löcher

7102009 LAMA
275-40-218-H22,5
4FORI /
BLADE 275-40-218-
H22,5 4 HOLES

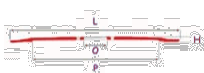

O= 40mm, P= 218mm,
L=275mm, h=22,5mm,
4Fori/Holes, 4Trous/
Orificios, 4 Löcher

7102023 LAMA
275-40-3F H15 BASSA
/
BLADE 275-40-3
HOLES H15

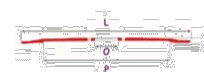

O=40mm P=230mm,
L=275mm,
3Fori/Holes, ,
3 Löcher
3Trous/Orificios

7102025 LAMA
BERKEL 296-58-4-240
/
BLADE BERKEL 296-
58-4-240

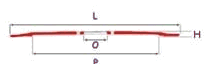

O= 58mm, P= 240mm,
L=296mm, H=20mm,
4Fori/Holes,
4Trous/Orificios,
4Löcher

7102029 LAMA
275-40-218-3F H 15
BASSA /
BLADE 275-40-218-3F
H 15

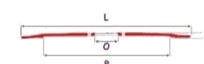
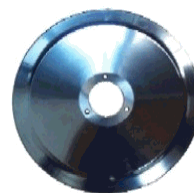

O= 40mm, P= 218mm,
L=275mm, H=15mm,
3Fori/Holes,
3Trous/Orificios,
3 Löcher

7102001 LAMA
300-40-245-17-3F /
BLADE 300-40-245-17

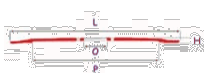
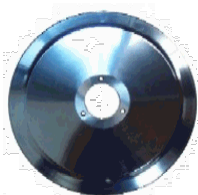

O= 40mm, P= 245mm,
L=300mm, h=17mm,
3Fori/Holes, 3Trous/O
rificios, 3 Löcher

7102003 LAMA
300-40-3-254-22,5 /
BLADE 300-40-3-254-
22,5

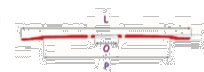

O= 40mm, P= 254mm,
L=300mm, h= 22,5mm,
3Fori/Holes,
3Trous/Orificios,
3 Löcher

7102011 LAMA
300-40-250 3 FORI /
BLADE 300-40-250 3
HOLES

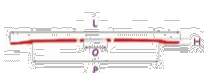
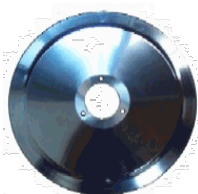

O= 40mm, P= 250mm,
L=300mm, h=19mm,
3Fori/Holes, 3Trous/
Orificios, 3 Löcher

7102008 LAMA
300-40-4 /
BLADE 300-40-4

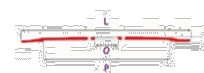

O= 40mm, P= 254mm,
L=300mm, h=22,5mm,
4Fori/Holes,
4Trous/Orificios,
4 Löcher

4 Löcher

7102002 LAMA
300-57-4-254-22,5 /
BLADE 300-57-4-254-
22,5

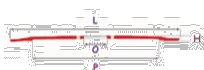

O= 57mm, P= 254mm,
L=300mm, h= 22,5mm,
4Fori/Holes,
4Trous/Orificios,
4 Löcher

7102007 LAMA
370-57-300-H22,5 4
FORI /
BLADE 370-57-300-
H22,5 4 HOLES

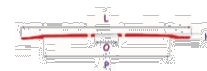

O= 57mm, P= 300mm,
L=370mm, h=22,5mm,
4Fori/Holes,
4Trous/Orificios, 4
Löcher

7102028 LAMA
BERKEL 315-57-271-
4F /
BLADE BERKEL 315-
57-271-4F
331500:
BERKEL S.P.A.

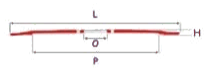

O= 57mm, P= 271mm,
L=315mm, 4
Fori/Holes,
4Trous/Orificios,
4 Löcher

7102038 LAMA 370
- 57 - 4 - 300 h. 22,5
C/RIALZO IT.
MACCHI /
BLADE 370-57-4-300H
MACCHI

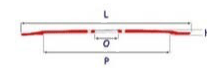
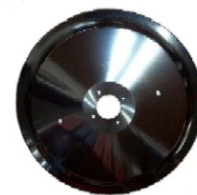

O=57mm, P=300mm,
L=380mm, H=22,5mm,
4Fori/Holes,
4Trous/Orificios,
4 Löcher

7102027 LAMA
330-40-270-3F /
BLADE 330-40-270-3F

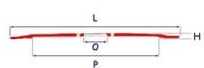

O= 40mm, P= 270mm,
L=330mm, 3
Fori/Holes,
3Trous/Orificios,
3 Löcher

7102039 LAMA 380
- 57 - 4 - 310 h. 22,5 ST
100CR6 /
BLADE 380-57-310-
4F 22,5H 100CR6

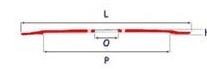

O=57mm, P=310mm,
L=380mm, H=22,5mm,
4Fori/Holes,
4Trous/Orificios,
4 Löcher

7102006 LAMA
330-57-4F
STANDARD /
BLADE 330-57-4
HOLES STANDARD

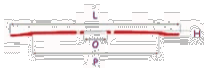

O= 57mm, P= 270mm,
L=330mm, h=22,5mm,
4Fori/holes,
4Trous/Orificios,
4 Löcher

7102034 LAMA
385-57-315- 4F 22,5H /
BLADE 385-57-315-
4F 22,5H

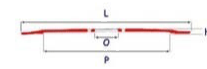

O=57mm, P=315mm,
L=385mm, H=22,5mm,
4Fori/Holes,
4Trous/Orificios,
4 Löcher

7102005 LAMA
350-57-4F /
BLADE 350-57-4
HOLES

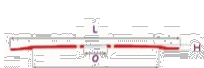

O= 57mm, P= 280mm,
L=350mm, h=22,5mm,
4Fori/Holes,
4Trous/Orificios,

SMERIGLI



COD.	A	B	C	Sbavatore - Affilatore	Adattabilità
4117702	48 mm	15 mm	14,3 mm	Affilatore	ABO c/capottina e CE - CEG BF300/350 OMEGA VS350-V33
4117703	51 mm	7 mm	14,3 mm	Sbavatore	
4117704	50 mm	12 mm	8 mm	Affilatore	BIZERBA 350CE- KOLOSSAL 300-350 I-VK new generation
4417705	54 mm	8 mm	8 mm	Sbavatore	
4117706	50 mm	8 mm	6 mm	Affilatore	ATOMA 250 / 300 FIA BOSTON
4117707	50 mm	8 mm	6 mm	Sbavatore	
4117708	45 mm	10 mm	8 mm	Affilatore	NOAW 220 / 250 / 300/ 350G
4117709	45 mm	10 mm	8 mm	Sbavatore	
4117710	50 mm	9 mm	6 mm	Affilatore	BIZERBA SE - VFII° TYPE - 35 FILAT MABIK - SWEDLINHAUS old type
4117711	50 mm	9 mm	6mm	Sbavatore	
4117702	48 mm	15 mm	14,3 mm	Affilatore	OMEGA VX 350 / 380 CE
4117712	58 mm	7 mm	14,3 mm	Sbavatore	
4117713	48 mm	15 mm	8 mm	Affilatore	OMS 350 CE new type
4117714	48 mm	8 mm	8 mm	Sbavatore	
4117715	43 mm	10 mm	8 mm	Affilatore	ARSA 220/250/300/330/300 LASER REGINA 250/300
4117716	43 mm	10 mm	8 mm	Sbavatore	
4117717	43 mm	12 mm	6 mm	Affilatore	OMS 250/300
4117718	43 mm	8 mm	6 mm	Sbavatore	
4117719	45 mm	13 mm	8 mm	Affilatore	SWEDLINHAUS 330/350/370
4117720	50 mm	8 mm	8 mm	Sbavatore	
4117721	50 mm	12 mm	12 mm	Affilatore	COLUMBIA 370 volano MARWEL 370/390-V c/affilatoio automat.
4117722	50 mm	9 mm	12 mm	Sbavatore	

S&P Cooking Catalogue 2017

COD.	A	B	C	Sbavatore - Affilatore	Adattabilità
4117723	51 mm	15 mm	14,3 mm	Affilatore	BIZERBA 350 CE - FILAT OMAS 300/330/350/370 H-L-C-CE
4117703	51 mm	7 mm	14,3 mm	Sbavatore	
4117724	50 mm	8 mm	7 mm	Affilatore	ABO affilatoio su vela
4117725	40 mm	10 mm	7 mm	Sbavatore	
4117726	50 mm	8 mm	8 mm	Affilatore	IRONWEED - VANDALL NUOVA LEO 300/330/350/370
4117727	45 mm	8 mm	8 mm	Sbavatore	
4117728	45 mm	9 mm	6 mm	Affilatore	FAC 300 PROFESSIONAL
4117707	50 mm	8 mm	6 mm	Sbavatore	
4117729	45 mm	8 mm	6 mm	Affilatore	ABM 250 / 300
4117730	45 mm	8 mm	6 mm	Sbavatore	
4117731	50 mm	12 mm	10,2 mm	Affilatore	ITALIANA MACCHI 300/330/350/370/ 390 / Mod. Euro
4117732	50 mm	10 mm	10,2 mm	Sbavatore	
4117733	40 mm	8 mm	6 mm	Affilatore	ALA 220/250-CELME 220/250/300 ESSEDUE 220/250-FAC 195/220/250E GENERAL M. 220/250/300-RGV 220/250 IRONWEED 220/250 - KOLOSSAL MISTRO 220/250 -RHENINGHAUS MONDIAL BETA CE
4117734	40 mm	8 mm	6 mm	Sbavatore	
4117735	45 mm	13 mm	6 mm	Affilatore	GENERAL MACHINE GM2000 350/370
4117730	45 mm	8 mm	6 mm	Sbavatore	
4117704	51 mm	12 mm	8 mm	Affilatore	KOLOSSAL old type 350/380 NOAW 350/370/400
4117727	45 mm	8 mm	8 mm	Sbavatore	

AFFILATORI

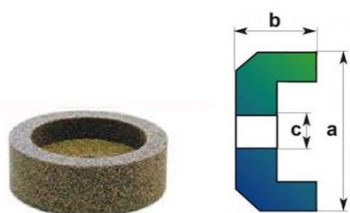

COD	A	B	C
4117702	48 mm	15 mm	14,3 mm
4117704	50 mm	12 mm	8 mm
4117713	48 mm	15 mm	8 mm
4117715	43 mm	10 mm	8 mm
4117719	45 mm	13 mm	8 mm
4117721	50 mm	12 mm	12 mm
4117723	51 mm	15 mm	14,3 mm
4117731	50 mm	12 mm	10,2 mm
4117735	45 mm	13 mm	6 mm

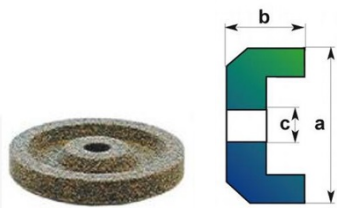

COD	A	B	C
4117706	50 mm	8 mm	6 mm
4117729	45 mm	8 mm	6 mm
4117733	40 mm	8 mm	6 mm

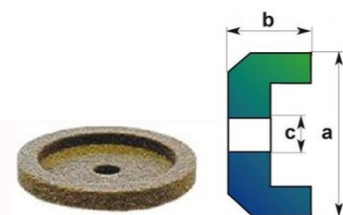

COD	A	B	C
4117708	45 mm	10 mm	8 mm
4117710	50 mm	9 mm	6 mm
4117717	43 mm	12 mm	6 mm
4117724	50 mm	8 mm	7 mm
4117725	40 mm	10 mm	7 mm
4117726	50 mm	8 mm	8 mm
4117728	45 mm	9 mm	6 mm

SBAVATORI

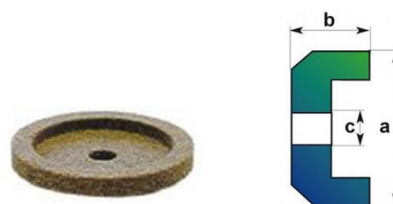

COD	A	B	C
4117703	51 mm	7 mm	14,3 mm
4117712	58 mm	7 mm	14,3 mm
4117718	43 mm	8 mm	6 mm
4117720	50 mm	8 mm	8 mm
4117722	50 mm	9 mm	12 mm
4117727	45 mm	8 mm	8 mm



COD	A	B	C
4117709	45 mm	10 mm	8 mm
4117711	50 mm	9 mm	6 mm
4117716	43 mm	10 mm	8 mm
4117717	43 mm	12 mm	6 mm
4117725	40 mm	10 mm	7 mm
4117732	50 mm	10 mm	10,2 mm



COD	A	B	C
4117705	54 mm	8 mm	8 mm
4117707	50 mm	8 mm	6 mm
4117714	48 mm	8 mm	8 mm
4117730	45 mm	8 mm	6 mm
4117734	40 mm	8 mm	6 mm

1143004 KIT
ANALISI DUREZZA
ACQUA 0-150MG/L /
WATER HARDNESS
TEST KIT



1143006 SIGILLAN
TE RACCORDI PTFE
100ml /
TEFLON PTFE
SEALING PASTE
100ml



1143020 ADESIVO
ISTANTANEO
MULTIUSO (fl20gr) /
MULTIUSE
INSTANTANEOUS
ADHESIVE (fl20gr)



1143021 LIQUIDO
SERRAFILETTI -
55°/+150° (tb50ml) /
TERMINAL-THREAD
LIQUID -55°/+150°
(tb50ml)



1143019 TUBO
GUARNIZIONE
LIQUIDA -55°/+200°
(75ml) /
LIQUID GASKET PIPE
-55°/+150° (75ml)



1143013 BARATTO
LO LOCTITE 55 /
LOCTITE POT 55



1143056 NASTRO
P.T.F.E. SPESSORE
12MT X 12mmX0,1
mm /
RIBBON P.T.F.E.
12MT X 12mm x
THICKNESS 0.1mm



1143007 GRASSO
150GR ALTA
TEMPERATURA /
HIGH
TEMPERATURE OILY
150GR



1143062 GRASSO
AL SILICONE PTFE
NSF 100G /
SILICONE OILY PTFE
NSF 100G



1143010 SILICONE
ROSSO T-65+260°
280ml /
RED SILICONE TUBE
T-65+260° 280ml
OE2186:
**ELECTROLUX
PROFESSIONAL
S.P.A.**



1143047 TUBETTO
SILICONE PER
PIASTRE VETRO
CERAMICA /
SILICONE TUBE FOR
GLASS CERAMIC
PLATES
PR13048: FABA SRL



1143025 PULITORE
LUCIDANTE
ACCIAIO 800ml -
INOX CLEANER /
STAINLESS STEEL
POLISHING
CLEANER 800ML



1143009 SPRAY
AIR 98 400ml /
SPRAY AIR 98 400ml



1143042 SPRAY
RILEVATORE FUGHE
DI GAS /
GASDETEKTOR
SPRAY



S&P Cooking Catalogue 2017

1143029 BARATTO
LO CC250 C/TAPPO /
POT CC250 WITH
STOPPER



1143017 CONFEZIO
NE S&P DS-CRT GR
1000 /
CALCIUM REMOVER
PACKING S&P DS-
CRT GR 1000



1143045 DISINCRO
STANTE
ANTICALCARE
ALL'ACETO 500ML /
VINEGAR ANTI-
LIMESTONE SCALE-
REMOVER 500ML



1143059 SCALEKL
EEN CONFEZIONE 1
KG /
SCALEKLEEN
PACKAGE 1 KG



1143028 SACCO
KG 25 DT-CF /
SACK 25KG DT-CF



1143040 ACTIVATE
D SCALE REMOVER
28 G /
ACTIVATED SCALE
REMOVER 28 G



1143041 SCALE
KLEEN SCALE
REMOVER /
SCALE KLEEN
SCALE REMOVER



1117044 MOLLA
BILANCIAMENTO
DX /
RIGHT TORSION
SPRING
669:
ARISTARCO
KASTEL SPA



1117045 MOLLA
BILANCIAMENTO SX
/
LEFT TORSION
SPRING
670:
ARISTARCO
KASTEL SPA

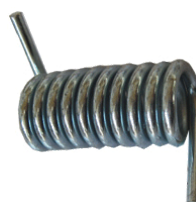

1117262 MOLLA
PIASTRA BERTO'S /
SPRING BERTO'S
30612800:
BERTO'S SPA



1117263 MOLLA
PIASTRA PD/VTR /
SPRING PD/VTR
30613100:
BERTO'S SPA



1117795 MOLLA
DX PORTE CIECHE
ARMADI MOLLA DX
ø 15x127 mm /
SPRING X SOLID
DOORS CABINETS
SPRING DX ø 15x127
mm
BN1412083:
MARENO
INDUSTRIE ALI
SPA
BN1412083:
LAINOX ALI SPA
BN1412083:
SILKO ALI SPA



1117796 MOLLA
SX PORTE CIECHE
ARMADI ø 15x127 mm
/
SPRING X SOLID
DOORS CABINETS
SPRING SX ø 15x127
mm
BN1412084:
MARENO
INDUSTRIE ALI
SPA
BN1412084:
SILKO ALI SPA



S&P Cooking Catalogue 2017

1117256 MOLLA
RICHIAMO F.3-31 SX
GREZZ /
LEFT SPRING F.3-31
KD01900:
OEM ALI SPA



1117257 MOLLA
RICHIAMO F.3-31 DX
GREZZ /
RIGHT SPRING F.3-31
KD01800:
OEM ALI SPA



1117726 MOLLA
F.2.5-16 CM.48
FORNO /
OVEN SPRING F.2.5-
16 CM.48
MDO4900:
OEM ALI SPA



1117736 MOLLA
PORTA TO F.3-19
INOX 111 /
DOOR SPRING TO
F.3-19 STEEL 111
MD10700:
OEM ALI SPA



1117033 MOLLA
3,2X21,5 PIASTRA E /
PLATE SPRING
3,2X21,5 MOD. E
69000650:
RANCILIO SPA
PR13032: FAB A SRL



1117034 MOLLA
3,8X22,7 PIASTRA S /
PLATE SPRING
3,8X22,7 MOD. S
*****:
RANCILIO SPA
PR10012: FAB A SRL



1117032 COPPIA
MOLLA PIASTRA
MEDIA SILANOS /
PLATE SPRING PAIR
SILANOS
904100+904101:
SILANOS SRL



1117066 MOLLA
PIASTRA S/D SX-DX /
LEFT-RIGHT PLATE
SPRING S/D
904080+904081:
SILANOS SRL

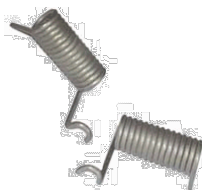

1117793 MOLLA
PIASTRA D/M VTC
DX. /
SPRING PLATE D / M
DX VTC.
904136:
SILANOS SRL



1117096 MOLLA
SOLLEVAMENTO SX
SIRMAN /
LEFT LIFTING
SPRING SIRMAN
IG5543C/99:
SIRMAN
IG5543/99:
SIRMAN



1117097 MOLLA
SOLLEVAMENTO DX
SIRMAN /
RIGHT LIFTING
SPRING SIRMAN
IG5540/99:
SIRMAN
IG5540C/99:
SIRMAN



1117301 MOLLA
CONTR/MANIG.
C/RONDELLE OTT.
PV 2063/2064 /
HANDLE SPRING
COMPLETE WITH
WASHERS AND
BUSH
XRPV13: VEMA SRL



1117130 MOLLA
PER RESISTENZA CB
/
SPRING FOR
HEATING ELEMENT
CB
HOT DOG - TP:
CB SRL



1117785 MOLLA
MANIGLIA /
SPRING FOR LEVER
C0008XX01:
FAMA INDUSTRIE
SRL
C0008XX01:
MACAP SRL



1117304 MOLLA
ESPULSORE PH85 /
EJECTOR SPRING
PH85
50SFA73715:
OEM ALI SPA



S&P Cooking Catalogue 2017

1117737 MOLLA
PORTA
635S+L+XL+935+435 /
DOOR SPRING
635S+L+XL+935+435
MD14800:
OEM ALI SPA



1117283 MOLLA /
SPRING
SL2385: FIMAR
S.P.A.



1117313 MOLLA A
SPIRALE /
SPIRAL SPRING
OC8561:
ELECTROLUX
PROFESSIONAL
S.P.A.



1117046 MOLLA X
NASELLO MANIGLIA
/
DOOR HANDLE
SPRING
R61620012:
LAINOX ALI SPA
LAR61620012:
LAINOX ALI SPA

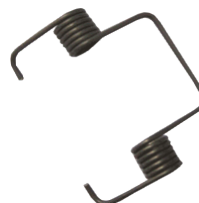

1117169 MOLLA
CHIUSURA PORTA;
FCV6 /
DOOR SPRING FCV6
002088:
ELECTROLUX
PROFESSIONAL
S.P.A.



1117185 MOLLA
RASCHIAPASTA /
SPRING
MD091R0:
OEM ALI SPA
MD09100:
OEM ALI SPA



1117147 "MOLLA
CHIUSURA PORTA;
FCV" /
SPRING FOR DOOR
FCV
054282:
ELECTROLUX
PROFESSIONAL
S.P.A.



4117001 SACCO
PIETRA LAVICA KG7
MEDIA /
PACKING OF LAVE
STONE 9 KG
05050501: CB SRL



1117798 MOLLA DI
SICUREZZA /
SAFETY SPRING
048298:
ELECTROLUX
PROFESSIONAL
S.P.A.



4117027 SET
ALESATORI 12 PEZZI
/
REAMERS KIT 12
PIECES



1117250 MOLLA
AGGANCIO
NASELLO 54x27mm /
SPRING
CONVECTION OVEN
OC6978:
ELECTROLUX
PROFESSIONAL
S.P.A.
LAR61620132:
OLIS DIVISIONE
DI ALI GROUP SPA
-
LAR61620132:
LAINOX ALI SPA
R61620132:
LAINOX ALI SPA



4117168 PIGNA
INOX GS/N SP/N TG
TRATTATA /
STAINLESS STEEL
VERTEX GS/N SP/N
TG
936:
ARISTARCO
KASTEL SPA



4117126 PIGNA
COMPLETA AS95 /
COMPLETE CONE
AS95
60148EX: CEADO
SRL
*: CEADO SRL
PRD0149EX:
FABA SRL
*: FABA SRL



S&P Cooking Catalogue 2017

4217357 PIGNA
CON SETACCIO (x
VASCETTA
ESTRAIBILE) /
PIGNA WITH SIEVE
FILTER (x TANK
REMOVABLE
XRSP37: **VEMA SRL**



4217349 OGIVA
SPREMIAGRUMI
PICCOLA /
SMALL OGIVE
JUICERS
C0007S8221:
MACAP SRL



4217446 PIGNA
NYLON MM95
SP/JOLLY /
NYLON CONE MM95
SP/JOLLY
2061:
ARISTARCO
KASTEL SPA



4117599 OGIVA
SPREMIAGRUMI P200
/
OGIVE FOR P200
C0007S822:
MACAP SRL
C0007S817ex:
MACAP SRL



4117156 OGIVA
GRANDE /
BIG VERTEX
70110: **CEADO SRL**
PR70110: **FABA SRL**
PRD0372: **FABA SRL**
DW60372:
DIHR-ALI SPA
*: **FABA SRL**



4217356 PIGNA
TRASPARENTE PER
VASCA FISSA /
PIGNA CLEAR FOR
JUICERS
XRSP11: **VEMA SRL**



4117164 OGIVA
PICCOLA
SPREMIAGRUMI /
SMALL VERTEX
DW60371:
DIHR-ALI SPA
70109: **CEADO SRL**



4117162 SETACCIO
SPREMIAGRUMI /
SQUEEZER SIEVE
*: **CEADO SRL**
PR70120: **FABA SRL**

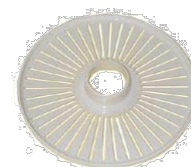

4117760 OGIVA
PICCOLA /
SMALL OGIVE
PR04040: **FABA SRL**



4217467 setaccio in
plastica per sm3 /
SIEVE FILTER FOR
SM3
PR04020: **FABA SRL**

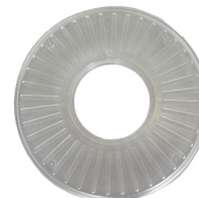

4117446 OGIVA
GRANDE PERNO
BIFRESATO /
OGIVA GREAT FOR
AXLE DOUBLE
MILLING
PR04015: **FABA SRL**



4117512 DISCO
FILTRO SP-SE /
FILTER DISK SP-SE
C0007S809:
MACAP SRL



4117772 OGIVA
GRANDE ACCIAIO
PERNO BIFRESATO /
OGIVE STAINLESS
STEEL AXLE
DOUBLE MILLING
PR04137: **FABA SRL**



4117948 PIATTINO
SPREMIAGRUMI /
DISC
C0007S820:
MACAP SRL



4117453 RECIPIEN
TE PLASTICA P202 /
CONTAINER P202
C0007S821:
MACAP SRL



S&P Cooking Catalogue 2017

4117454 SOTTOCE
STA PLASTICA
SPREMIAG. /
BASKET FOR JUICER
C00075810:
MACAP SRL



4117482 SUPPORT
O VASCETTA
SPREM. /
JUICER TANK
HOLDER
60304: CEADO SRL
DW61059:
DIHR-ALI SPA



4117447 CUPOLA
PROTEZIONE SP /
COVER SP
C00075807:
MACAP SRL



4117958 CUPOLA
PARASPRUZZI /
DOME MUDFLAPS
PR70130: FABBA SRL



4217223 CAMPANE
LLA SPREMUTA SP/N
/ BELL JUICE SP / N
937:
ARISTARCO
KASTEL SPA



4217178 CAMPANE
LLA INOX
SPREMUTA /
BELL INOX JUICE
942:
ARISTARCO
KASTEL SPA



4117198 CAMPANE
LLA SPREMIAGRUMI
PER GM2-3-4 /
CONE AS95 GM2-3-4
20509: CEADO SRL



4117523 CAMPAN
A INOX SPREMIAGR.
COMPL. /
BELL JUICE
COMPLETE
C00045817:
MACAP SRL



4117685 BELL
COVER INOX /
BELL COVER INOX



4117294 ASSIEME
BICCHIERE
FRULLATI
POLICARBONATO /
GLASS FOR
FRAPPE F1-F2
POLICARBONATO
9675C:
ARISTARCO
KASTEL SPA
9675Aex:
ARISTARCO
KASTEL SPA



4117979 ASS.
BICCHIERE FRAPPE'
POLICARB. /
ASSEMBLY GLASS
FRAPPE
POLYCARBONATE
9676C:
ARISTARCO
KASTEL SPA



4117167 BICCHIER
E LT.1 COMP.
FRAPPE' C/MANICO /
COMPLETE FRAPPE'
GLASS 1 LT WITH
HANDLE
134110:
ARISTARCO
KASTEL SPA



4117498 BICCHIER
E PLASTICA 1,5 LITRI
SOLO CONTENITORE
/ PLASTIC GLASS
9487:
ARISTARCO
KASTEL SPA



4117499 TAPPO
COPERCHIO
BICCH.1,5 LT PLAST.
PER BICCHIERE DA
1,5 LT. /
GLASS COVER
9470:
ARISTARCO
KASTEL SPA



4117501 COPERCHI
O BICCH. DA 1,5
LT. PLASTICA PER
BICCHIERE DA 1,5
LT. /
GLASS COVER

9471:
ARISTARCO
KASTEL SPA



4117128 ASSIEME
CONO CON ASSE
COMPLETO DI
PIATTELLO /
CONE SET WITH
AXIS
COMPREHENSIVE OF
PLATE

PRD0181ex: FABA
SRL
PR90102: FABA SRL



4117869 ASS.
ZOCOLO FRULLATI
POLICARB. /
KNIVES SET
COMPLETE

9673C:
ARISTARCO
KASTEL SPA



4117132 ZOCCOLO
BICCHIERE
FRULLATORE /
MIXER GLASS CLOG

70101: CEADO SRL
DW60184:
DIHR-ALI SPA
PRD0184: FABA SRL



4117824 ZOCCOLO
COMPLETO X
FRULLATI /
KNIVES SET
COMPLETE

1343:
ARISTARCO
KASTEL SPA



4217012 ZOCCOLO
BICCHIERE /
BASE GLASS

DW60110:
DIHR-ALI SPA



4117117 BICCHIER
E COMPL. X
FRULLATI F1-F2
POLICARBONATO /
GLASS FOR FRAPPES
F1-F2
POLICARBONATO
PRD0176: FABA SRL



4117058 ZOCCOLO
BICCHIERE VETRO /
GLASS-CLOG

PRD0110: FABA SRL



4117121 COPERCHI
O COMPLETO
BICCHIERE 1,5L
FRULLATORE /
COMPLETE CAP FOR
MIXER 1,5L

PR90104+PR70107:
FABA SRL
90104: CEADO SRL
DW60182:
DIHR-ALI SPA
PRD0182: FABA SRL



4217083 COPERCHI
O FRULLATORE
F1300 /
COVER MIXER F1300

CO1415: FIMAR
S.P.A.



4117127 ASSIEME
COLTELLI CON ASSE
COMPLETO DI
PIATTELLO /
KNIVES SET WITH
AXIS
COMPREHENSIVE OF
PLATE

DW60116*:
DIHR-ALI SPA
*: CEADO SRL
PR90101: FABA SRL



4217084 IMBUTO /
FUNNEL

CO1408: FIMAR
S.P.A.



4117675 BICCHIER
E P100 COMPLETO /
COMPLETE GLASS
P100

CO007F342:
MACAP SRL



S&P Cooking Catalogue 2017

4117676 BICCHIER
E P100 MIXER
COMPLETO /
COMPLETE GLASS
MIXER P100
C0007F343:
MACAP SRL



4117911 BICCHIER
E FRULLATORE
NUDO /
GLASS BLENDER
C0007F304:
MACAP SRL



4117642 COPERCHI
O COMPLETO PER
FRULLATORE P100 /
COVER COMPLETE
BLENDER P100
C0007F347:
MACAP SRL



4217358 COPERCHI
O FRULLATORE
COMPLETO P105 /
FULL COVER - FOR
BLENDER P105
C0007F351:
MACAP SRL



4117940 TAPPO
ISPEZIONE
FRULLATORE /
BLENDER COVER
CAP
C0007F317A:
MACAP SRL



4217359 SUPPORT
O COLTELLI ICE
BREAKER /
SUPPORT BLADES -
ICEBREAKER
C0001F322:
MACAP SRL



4117789 SUPPORT
O COLTELLI
FRULLATORE /
KNIVES SUPPOR FOR
BLENDER
C0007F305:
MACAP SRL



4217072 SUPPORT
O COLTELLI P103 /
BLADE SUPPORT
P103
C0001F346:
MACAP SRL



4117797 SUPPORT
O MIXER
FRULLATORE /
MIXER SUPPORT
C0007F306:
MACAP SRL



4217181 Blocco inox
Frull. L.5 compl. /
Block steel for Blender
L.5 compl
C0004F322:
MACAP SRL



4117788 PORTA
BICCHIERE
FRULLATORE /
BASE
C0007F321:
MACAP SRL



4217453 BICCHIER
E FILETTATO
TRASPARENTE
FR2002 /
PLASTIC JUG 1.2 L
XRFR1: VEMA SRL



4117433 BICCHIER
E POLICARBONATO /
GLASS
PR70113: FABA SRL



4117378 BICCHIER
E ACCIAIO FABA B1 /
STAINLESS STEEL
GLASS FABA B1
PR20515: FABA SRL



4217278 BICCHIER
E PLASTICA
FRULLINO /
GLASS PLASTIC
BEATER
C0007F218:
MACAP SRL

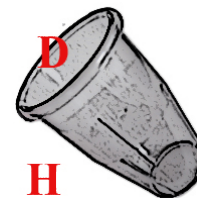

DIAMETER= 110 mm,
HEIGHT= 170 mm

S&P Cooking Catalogue 2017

4217454 BICCHIERE INOX FRULLINO / STAINLESS STEEL JUG
C0004F215:
MACAP SRL



4117827 DIST. FRULLINO STAR-GSN / SPACER STAR-GSN
5177:
ARISTARCO
KASTEL SPA



4217124 LAMA FRULLATI DIS.1657 / BLADE SMOOTHIES DIS.1657
4684:
ARISTARCO
KASTEL SPA



4117118 COPPIA INGRANAGGI FRULLATORE CEADO / PAIR GEARS FOR MIXER CEADO
*: DIHR-ALI SPA
*: CEADO SRL
PRD0107: FABA SRL



4117823 COPPETTA A GIUNTO GS/N DIS.847 / COUPLING CUP GS/N DIS.847
1006:
ARISTARCO
KASTEL SPA



4217162 #PULEGGI A FRIZIONE + DADO (61068) / CLUTCH PULLEY + NUT (6106)
DW60156:
DIHR-ALI SPA



4117825 COPRIGIUNTO GS/N-STAR / COUPLING COVER GS/N STAR
992:
ARISTARCO
KASTEL SPA



4217032 TRASCIN. BICCH. FRULL. P105 / DRIVER GLASS BLENDER P105
C0002F306:
MACAP SRL



4217424 ASSIEME BOCCOLA PER ZOCCOLO / ASSEMBLY BUSH FOR BASE
9539ex:
ARISTARCO
KASTEL
10519:
ARISTARCO
KASTEL



Ø=74mm

4117804 TRASCINATORE GOMMA FRULLATORE / RUBBER DRIVER FOR BLENDER
C0007F308:
MACAP SRL



4117826 PIGNONE X GS/N-STAR C/RONDELLA / PINION FOR GS/N-STAR
1000:
ARISTARCO
KASTEL SPA



4217433 XR/450-350 COLTELLO INOX / XR/450-350 KNIFE INOX
50SEA78528:
OEM ALI SPA



4117637 GIUNTO CENTRIFUGO DIS.37 / CENTRIFUGAL COUPLING DIS.37
1001:
ARISTARCO
KASTEL SPA



4217335 COLTELLO 2 LAME PER CUTTER CL5/8 / KNIFE 2 BLADES FOR CUTTER CL5 / 8
COLCL58L2:
FIMAR S.P.A.



S&P Cooking Catalogue 2017

4117532 GRUPPO
LAMA BLIXER 3
PLUS /
BLADE BLIXER 3
PLUS



4217275 COLTELL
O COMPLETO /
SMOOTH BLADE
ASSEMBLY WITH
BOSS



4217276 DISCO
EMULSIONATORE /
EMULSION DISC



4217529 COLTELL
O DENTATO FINE /
SERRATED KNIFE
FINE



4217522 GRUPPO
COLTELLI
COMPLETO MINI MP
/
COMPLETE KNIVES
GROUP MINI MP



4117965 PULEGGIA
IN ALLUMINIO /
PULLEY ALUMINUM
DW60154:
DIHR-ALI SPA



4117644 FRIZIONE
COMPLETA /
COMPLETE CLUTCH
PR90131: FABBA SRL
DW61054:
DIHR-ALI SPA
*: CEADO SRL



4117840 MESCOLA
TORE 400MM
STANDARD /
IMMERION ARM
400MM STANDARD
ME4040:
FIMAR S.P.A.



4117667 MESCOLA
TORE L 400MM /
IMMERION ARM
400MM
MESCFM340:
FIMAR S.P.A.



4217318 GRUPPO
MIXER COMPLETO /
COMPLETE
IMMERION ARM
ROBOT COUPE



4217041 Albero di
comando GV35 - GV70
/
Control shaft GV35 -
GV70
04CC0019: CB SRL



4117964 Supp. SX
per movimento
GV/GVP24 - GV35 -
GV/GVP24 - GV70 /
COUPLING
GV/GVP24-GV35-
GV/GVP24-GV70
04CC0020: CB SRL



4117317 PERNO
PORTASCHIDIONE /
SPIT-HOLDER PIN
G8/12P-G20P-E6P-
E15P/S5-E20P/S5-
E30P/S5: CB SRL
04010527EX: CB
SRL



4117397 BLOCCO /
BLOCK
059864: E
LECTROLUX
PROFESSIONAL
S.P.A.



4117668 GIUNTO /
COUPLING
SL1496: FIMAR
S.P.A.



4117739 GIUNTO /
COUPLING
SA1063: FIMAR
S.P.A.



4117832 ESPULSO
RE 3 RAZZE TV98 /
EXPELLER DISC
TV98
AU50SCA78300:
OEM ALI SPA

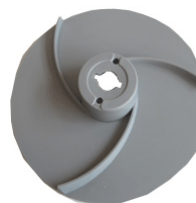

4117740 INSERTO /
INSERT
SL3611: FIMAR
S.P.A.



4217254 SPIRALE
IMPASTATRICE /
SPIRAL MIXER
SL0069: FIMAR
S.P.A.
SL0069:
MBM- EUROTEC SRL
- DIV. COOKING
SERVICE



4217432 XR/350-450
GIUNTO
GR.MASCHIO /
XR/350-450 BIG
MALE COUPLING
50SBA78365:
OEM ALI SPA



A=8mm, B=6mm

4117652 SPIRALE
IMPASTATRICE
FIMAR /
SPIRAL MIXER
FIMAR
SA1030: FIMAR
S.P.A.



4217434 PART /
PART
50IAA78337:
OEM ALI SPA



A=18mm, B=9mm,
C=18,5mm, H=4mm,
E=8,5mm, H=14mm

4217372 SPIRALE
PER IMPASTATRICE
IM38T /
SPIRAL MIXER IM 38
T
IMX25021:
MECNOSUD SRL



4117905 DISCO
ESPULSORE ALTO /
HIGH EXPELLER
DISC
SA2700: FIMAR
S.P.A.



Ø=200mm

4117609 SPIRALE
IMPASTATRICE 10
KG /
SPIRAL MIXER 10 KG
AH03500:
OEM ALI SPA



4217537 DISCO
ESPULSORE BASSO /
LOW EXPELLER
DISC
SL0843: FIMAR
S.P.A.



Ø=200mm

4217328 GANCIO
IN ALLUMINIO -
PTM/10 -(SM101024) /
HOOK IN
ALUMINIUM - PTM /
10 -
RC909R0:
OEM ALI SPA



4217051 DISCO
ESPULSORE /
EXPELLER DISC



4117886 FRUSTA
PER MESCOLATRICE
DA 5 LITRI /
BEATER 5LT
653250:
ELECTROLUX
PROFESSIONAL
S.P.A.



4117773 FRUSTA
IMPASTATRICE
PLANETARIA /
WHISK MIXER
ACK5AWW:
FIMAR S.P.A.



4117818 FRUSTA
FM3 /
WHISK FM3
FRUSTAFM3:
FIMAR S.P.A.



4217244 SPATOLA
INOX PER
MESCOLATRICE 5L /
SPATULA
STAINLESS STEEL
MIXER 5L
653252:
ELECTROLUX
PROFESSIONAL
S.P.A.
653756:
ELECTROLUX
PROFESSIONAL



4117956 PTM/10
PALA (SM101023) /
PTM /
10 SHOVEL
(SM101023)
RC915R0:
OEM ALI SPA



4217212 COCLEA
GHISA /
CAST IRON AUGER
F2123:
FAMA INDUSTRIE
SRL



4217251 SPIRALE
COMPLETA BM1-
2(AH015+KF030) /
SPIRAL BM 1-2 (AH
015 + KF030)
KF032R0:
OEM ALI SPA



4217138 COCLEA
INOX CEG MOD. T22 /
AUGER STEEL MOD
CEG. T22



4217309 RULLO
INOX GRATTUGIA 10
COMPLETO DI
FLANGE external ø 78
mm - external ø fitting
35 mm--pin ø 12 mm -
roller length 138 mm /
GRATER ROLLER
MOD.10 DUPLEX
external ø 78 mm -
external ø fitting 35
mm--pin ø 12 mm -
roller length 138 mm
30-16163:
ING. ROMEO
AGUSTONI SRL



4117655 RULLO
GRATTUGIA
AGUSTONI /
ROLLER GRATER
AGUSTONI



4117545 RULLO
GRATTUGIA FAMA
D.78MM L.146MM
FORO 25MM /
GRATER ROLL
FAMA D.78MM
L.146MM HOLE
25MM
F2156:
FAMA INDUSTRIE
SRL



4217088 TGX-
12+MRX/G C.RULLO
GRATTUGIA /
TGX-12+MRX/G
ROLLER GRATER
60XBB78200:
OEM ALI SPA



4117558 RULLO
GRATTUGIA FORO
18 D.84 L144 /
GRATER ROLL HOLE
18 D.84 L144



4117493 RULLO
GRATTUGIA INOX /
STAINLESS STEEL
GRATER ROLL



4117764 PIASTRA
INOX MOD. 8 FORI Ø
4,5 MM. /
PLATE FOR MINCER
8 HOLES D.4,5MM



4217311 PIASTRA
INOX MOD. 12 fori Ø 8
mm. /
SELF-SHARPENING
STAINLES STEEL
PLATE 12/8mm



4117765 PIASTRA
INOX MOD. 8 FORI Ø
6 MM. /
PLATE FOR MINCER
8 HOLES D.6MM



4217342 PIASTRA
INOX MOD. 12 fori Ø
10 mm. /
PLATE MINCER
MOD. 12 fori Ø 10 mm.



4217296 PIASTRA
TRITACARNE
MANUALE MOD. 12
fori Ø 4,5 mm. /
PLATE MINCER
MOD. 12 holes Ø 4.5
mm.



F2131:
**FAMA INDUSTRIE
SRL**

4117768 PIASTRA
INOX MOD. 22 FORI
Ø 4,5 MM. /
PLATE MINCER
MOD. 22 fori Ø 4,5
mm.



**F2219: FAMA
INDUSTRIE SRL**

4117766 PIASTRA
INOX MOD. 12 FORI
Ø 4,5 MM. /
PLATE MINCER INOX
STEEL MOD. 12 holes
Ø 4.5 mm.



4117769 PIASTRA
INOX MOD. 32 FORI
Ø 4,5 MM. /
PLATE MINCER
MOD. 32 fori Ø 4,5
mm.



4217297 PIASTRA
TRITACARNE
MANUALE MOD. 12
fori Ø 6 mm. /
PLATE MINCER
MOD. 12 holes Ø 6 mm.



F2131:
**FAMA INDUSTRIE
SRL**

4117770 PIASTRA
INOX MOD. 32 FORI
Ø 6 MM. /
PLATE MINCER
MOD. 32 fori Ø 6mm.



4117767 PIASTRA
INOX MOD. 12 FORI
Ø 6 MM. /
PLATE MINCER INOX
STEEL MOD. 12 holes
Ø 6 mm.



4117691 PIASTRA
INOX MOD. 22 FORI
Ø 6 MM. /
PLATE MINCER
MOD. 22 fori Ø 6 mm.



4217298 PIASTRA
TRITACARNE
MANUALE MOD. 12
fori Ø 8 mm. /
PLATE MINCER
MOD. 12 holes Ø 8 mm.



F2131:
**FAMA INDUSTRIE
SRL**

4117701 PIASTRA
INOX MOD. 22 FORI
Ø 8 MM. /
STEEL PLATE MOD.
22 HOLES Ø 8 MM.

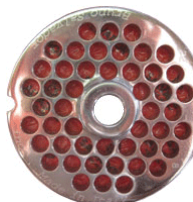

4217380 PIASTRA
INOX MOD. 32 fori Ø
10 mm. /
PLATE MINCER
MOD. 32 fori Ø 10 mm.



4117696 COLTELL
O INOX MOD. 8 /
KNIFE INOX MIXER
MOD.8



4117474 COLTELL
O TRITACARNE
SIRMAN MOD.12 /
KNIFE MIXER
SIRMAN

F2130:

FAMA INDUSTRIE
SRL



4117678 COLTELL
O INOX MOD. 22 /
KNIFE INOX MOD. 22

50SEA72635:

OEM ALI SPA

F2218:

FAMA INDUSTRIE
SRL



4117763 COLTELL
O INOX MOD. 32 /
KNIFE INOX MOD.32



4217351 COLTELL
O INOX MOD. 32
SALDOBRASATO /
KNIFE INOX MOD. 32
brazed



4217334 DISCO
FETTE INOX-LAME
'S'-1 MM /
DISK SLICES INOX -
BLADES 'S'-1 MM

653729:

ELECTROLUX
PROFESSIONAL
S.P.A.



4217343 DISCO
PER AFFETTARE 2
LAME 4MM E4 /
DISK TO SLICE 2
BLADES 4 MM E4

E4: FIMAR S.P.A.



4217344 DISCO E14
/
DISK E14

E14: FIMAR S.P.A.



4217252 DISCO
PER AFFETTARE E8 /
CUTTING DISK E8

E8: FIMAR S.P.A.



4217308 COPPIA
DISCO FETTE 3 MM /
COUPLE SLICES
DISC 3MM

60XAD70567:

OEM ALI SPA



4217189 DISCO
TAGLIAVERDURE
MOD. E 10 CEG /
DISC VEGETABLE
MOD. And 10 CEG



4217413 DISCO
FETTE 1 MM /
SLICES DISC 1MM

60XAD70565:

OEM ALI SPA



4217439 DISCO
FIAMMIFERI 6X6 /
DISC 6X6

60XAD70574:

OEM ALI SPA



4217440 DISCO
LAMA STANDARD
6MM /
DISC STANDARD
BLADE 6MM

60XAD70569:

OEM ALI SPA



4217449 DISCO
2,5X2,5 FIAMMIFERI
E BASTONCINI /
DISC 2,5X2,5

60XAD70589:

OEM ALI SPA



4217450 LAMA
STANDARD 8MM /
DISC STANDARD
8MM

60XAD70570:
OEM ALI SPA



4217052 DISCO
SFILACCIO
MOZZARELLA 7MM /
SHREDDING DISC
MOZZARELLA 7MM



4217451 DISCO
CUBETTI 8X8 /
DISC CUBES 8X8

60XAD78830:
OEM ALI SPA

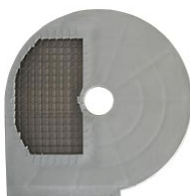

4117954 GRIGLIA
CUBETTI 20X20 /
CUBES GRID 20X20

60XAD78833:
OEM ALI SPA

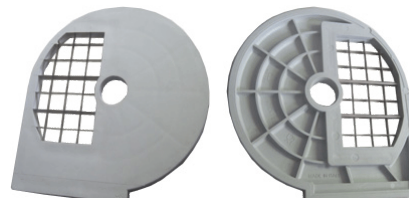

4217361 DISCO
TAGLIAVERDURE
PER JULIENNE Z4 /
DISK FOR
VEGETABLE
CUTTER JULIENNE
Z4

Z4: FIMAR S.P.A.



4117350 PIATTO
COMPLETO D 140mm
GYROS CB /
COMPLETE PLATE
FOR GYROS CB
D.140mm

GYROS: CB SRL

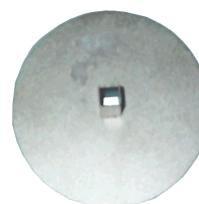

4217253 DISCO
PER SFILACCIARE Z7 /
DISK Z7

Z7: FIMAR S.P.A.



4117347 PIATTO
COMPLETO D.200mm
GYROS /
COMPLETE PLATE
FOR GYROS CB
D.200mm

GYROS: CB SRL

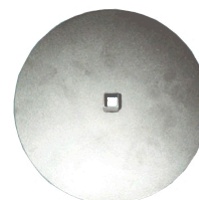

4117894 DISCO
PER
TAGLIAMOZZARELL
E Z7 PER
SFILACCIARE /
DISK Z7

DISCO Z7 MM:
FIMAR S.P.A.



4117030 DISCO
TUTTAPIASTRA GAS
026953 /
DISK 026953

026953:
ELECTROLUX
PROFESSIONAL
S.P.A.

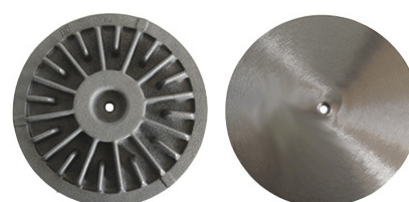

4217341 DISCO
TAGLIAMOZZARELL
A Z7 AUREA /
DISK MOZZARELLA
CUTTER - Z7 AUREA

60XAD70579:
OEM ALI SPA



4117452 DISCO IN
GHISA D.350
LAMATO /
DISC CAST IRON
BASED COAT D.350

PR3052: FABA SRL

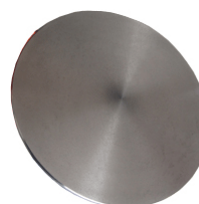

4217406 DISCO 8
MM /
DISK 8 MM

50HAA78068:
OEM ALI SPA



4117151 DISCO IN
GHISA CREPIERE D.
400 LAMATO /
DISC CAST IRON
CREPIERE D. 400
sanded

PR36060: FABA SRL

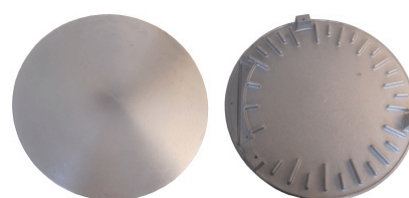

4217129 SOTTOFO
NDO CESTO INOX /
BACKGROUND
STEEL BASKET

PR20530: FABA SRL



4117994 DISCO
 PRESSA A5 /
 CLAMING DISC A5
C0007A501:
MACAP SRL



4217174 CONTRO
 PIATTO ROTONDO
 COMPLETO DI
 PLASTICA /
 AGAINST ROUND
 DISH WITH PLASTIC
KA03110:
OEM ALI SPA

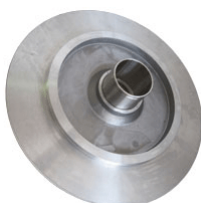

4117496 SUPPORT
 O R. BRILLANTATO
 C/FORI /
 BURNER ROSETTE D.
 70mm
BN6A041700:
OLIS DIVISIONE
DI ALI GROUP SPA



-
1032009300:
MARENO
INDUSTRIE ALI
SPA
0100259:
SILKO ALI SPA
22282700:
BERTO'S SPA
MA1032009300:
MARENO
INDUSTRIE ALI
SPA

4117953 PIATTELL
 O COMPLETO
 PELAPATATE /
 COMPLETE
 POTATOS CUTTER
 DISK



4217239 CINGHIA
 PIATTA 23X457 10
 NERVATURE /
 FLAT BELT 23X457 10
 RIBS



4217240 CINGHIA
 PIATTA 12X660 6
 NERVATURE /
 FLAT BELT 12X660 6
 RIBS



4217097 CINGHIA
 PIATTA 20 X 360 10
 NERVATURE /
 FLAT BELT 20 X 360
 10 RIBS



4117746 CINGHIA
 PIATTA 22 X 430 11
 NERVATURE TB2430
 /
 FLAT BELT 22 X 430
 11 RIBS TB2430



4117867 CINGHIA
 TB2.34 360X10 /
 BELT TB2.34 360X10
CO3927: FIMAR
S.P.A.



4217141 CINGHIA
 PIATTA 22 X 480 11
 NERVATURE /
 FLAT BELT 22 X 480
 11 RIBS



4217377 CINGHIA
 PIATTA 21 X 711 9
 NERVATURE /
 FLAT BELT 21 X 711 9
 RIBS



4217403 CINGHIA
 PIATTA 22X510 11
 NERVATURE /
 FLAT BELT 25X510 11
 RIBS



4217320 CINGHIA
 PIATTA 16X380 8
 NERVATURE /
 FLAT BELT 16X380 8
 RIBS



4217534 CINGHIA
 TB2-480 20MM 10
 NERVATURE /
 BELT TB2-480 20MM
 10 RIBS



4217365 CINGHIA
TRAPEZOIDALE 10 X
605 - Z23 3/4 /
TRAPEZOIDAL BELT
10 X 605 - Z23 3/4

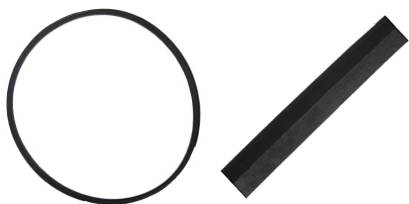

4217427 TBS140
CINGHIA POLY V
2337 J12 /
TBS140 BELT POLY V
2337 J12



ODO190:
ELECTROLUX
PROFESSIONAL
S.P.A.

4217247 CINGHIA
TRAPEZOIDALE 6 X
352 /
V-BELT 6 X 352

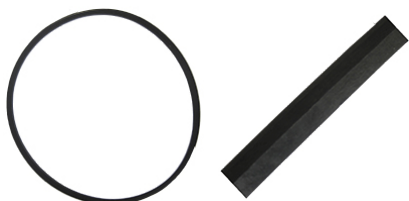

4217533 "CINGHIA
TRASMISSIONE;
POLY V 559 J8" /
BELT
TRANSMISSION
POLY V 559 J8



OKJ065:
ELECTROLUX
PROFESSIONAL
S.P.A.

8 NERVATURE

4117515 CINGHIA
PU 8X680 /
BELT PU 8X680



AD172R0ex:
OEM ALI SPA
AD17200:
OEM ALI SPA

4217115 CINGHIA
POLY-V CP220J16 /
BELT POLY-V
CP220J16



50LDA71330:
OEM ALI SPA

4117516 CINGHIA
D.8X920 /
BELT D.8X920



RC217R0:
OEM ALI SPA

4217026 ANELLO
SEGAOSSA
1760X16X6 mm.
PUNTE TEMP. /
RING BONE SAW
1760X16X6 mm. TIPS
HARDENED



DIMENSIONS
1760X16X6 mm

4217277 CINGHIA
TRAPEZOIDALE 8 X
630 /
V.BELT 8X630

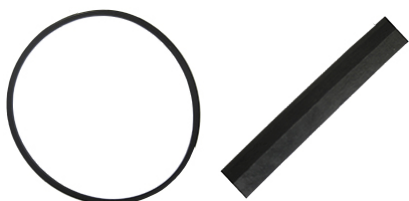

4117566 SMERIGLI
O GRANA GROSSA /
EMERY



PRT0641: FABA SRL

4217286 CINGHIA
DENTATA A35
F201T+F201M 0920
AX35 889 Li /
TOOTHED BELT 0920
AX35 889 Li



AD08800:
OEM ALI SPA

4117567 SMERIGLI
O GRANA FINE /
EMERY



PRT0642: FABA SRL

4217268 PTM/10
CINGHIA DI
TRASMISSIONE /
PTM /
10 DRIVE BELT



RC901R0:
OEM ALI SPA

4217368 SMERIGLI
O "Ø est. 43; h. 8; foro 6
mm. COLTELLO
GRANA GROSSA " /
STONE "ext. 43; h8;
hole 6 mm. KNIFE
COARSE GRAIN"



4117735 SMERIGLI
O Ø EST. 45; H. 13;
FORO 6 MM. TAZZA
GRANA GROSSA /
STONE Ø EST. 45; H.
13; HOLE 6 MM. CUP
COARSE GRAIN



4217155 DISCO
COPRILAMA 275
FABA /
DISC BLADE 275
FABA
PRTO491: FABA SRL

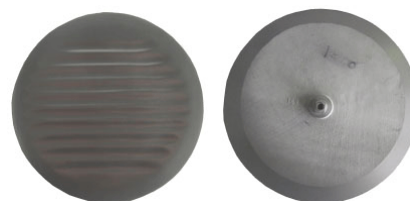

4117555 AFFILATO
IO ALLA VELA RGV /
SHARPENER RGV



4217013 COPRILA
MA NOAW 350TC10 /
Blade cover NOAW
350TC10



4217018 C.CARREL
LO
REG.DOS.BM/2(KF029
) /
CART DOSE
ADJUSTMENT BM / 2
(KF029)



KF05410:
OEM ALI SPA

4117683 OLIO PER
POMPA
SOTTOVUOTO A 32
LT. 1 /
PUMP OIL ISO 32 LT.
1



4217114 "ECCENTR
ICO CELME foro Ø 14
mm.; Ø est. 76 mm.
MOD.350/370" /
ECCENTRIC CELME
hole Ø 14 mm.; Ext.
76mm. MOD.350/370



4117755 OLIO
BIANCO LT. 1 /
WHITE OIL LT.1
TYPE VE



4117774 "ECC.
ESSEDUE CE FORO Ø
12 MM.; Ø EST. 56
MM." /
ECCENTRIC
ESSEDUE CE HOLE Ø
12 MM.; Ø
EXTERNAL 56MM

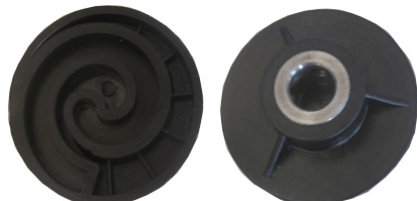

4117756 OLIATORE
PLASTICA 50 CC. /
PLASTIC OILER
50CC.



4117624 "ECC.
FORO Ø 12 MM. ; Ø
EST. 54 MM." /
ECCENTRIC HOLE Ø
12 MM.; Ø
EXTERNAL 54MM

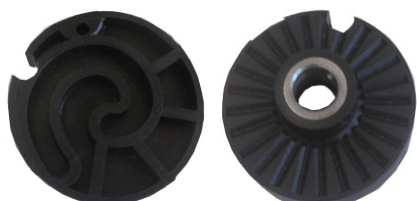

4117365 CATENA
64 PASSI P8 W12/5 /
CHAIN 8X3MM W12/5
W12/5: CB SRL



4217082 ECCENTRI
CO PRIMA
OBERWERK /
ECCENTRIC PRIMA
OBERWERK



4117366 CATENA
82 PASSI P8 W18/7-
W24/7 /
CHAIN 8X3MM
W18/7-W24/7
W18/7- W24/7:
CB SRL



4117367 CATENA
100 PASSI P8 W32/9 /
CHAIN 8X3MM W32/9
W32/9: CB SRL



S&P Cooking Catalogue 2017

4217447 CATENA /
CHAIN
SL3363: FIMAR
S.P.A.



4217448 CATENA /
CHAIN
SL0102: FIMAR
S.P.A.



4217187 CATENA
SPIRALE /
CHAIN SPIRAL
IMX25022:
MECNOSUD SRL



4217452 SPEZZ.CA
T.1/2S 67 R.STIRATA
CPG 86 CM /
CHAIN
5400005:
OEM ALI SPA



4217004 CONO
D.3,5 /
CONE D.3 5
AH027RO:
OEM ALI SPA



4217005 CONO
D.4,5 /
CONE DIAMETER 4,5
AH022RO:
OEM ALI SPA



4117836 IMBUTO
(180-220gr) /
FUNNEL (180-220gr)
AH025RO:
OEM ALI SPA



4117946 IMBUTO
D=65MM BM1-2 (GR
210-250) /
FUNNEL D=65mm
BM1-2 (GR 210-250)
AH026RO:
OEM ALI SPA



4217150 CONO D.7
GR.240/300 /
CONE D.7 GR.240 /
300
OMAH044RO:
OEM ALI SPA



4217317 COPERCHI
O COMPL. +
GUARNIZIONE /
CUTTER LID ø 225
mm
3031610:
ANGELO PO
GRANDI CUCINE
SPA



4217310 COPERCHI
O COMPLETO
GRATTUGIA 10 /
COVER COMPLETE
GRATTUGIA 10
22-15137:
ING. ROMEO
AGUSTONI SRL



4117357 COPERCHI
O PER TUBO PIREX /
LID FOR HOT-DOG
GLASS
HOT DOG - SW1:
CB SRL



4217100 COPERTU
RA /
COVERING
OKJ025:
ELECTROLUX
PROFESSIONAL
S.P.A.



4217398 COPERCHI
O IM25 /
POLYCARBONATE
COVER FOR TANK
SA1006: FIMAR
S.P.A.



S&P Cooking Catalogue 2017

4217404 COPERCHI
O IMPASTATRICE A
SPIRALE IM38S /
POLYCARBONATE
COVER FOR TANK
IM38S
SA1007: FIMAR
S.P.A.



4117876 COPERCHI
O IN ACCIAIO IM18 /
STEEL COVER IM18
SL3418: FIMAR
S.P.A.



4217329 COPERCHI
O GRATTUGIA /
COVER GRATER
50SCA74951:
OEM ALI SPA



4117693 C.COPERC
HIO TP.N.LUC. /
COVER
50HAA78020:
OEM ALI SPA



4117957 PVM4/6
COPERCHIO+GUARN
IZIONE /
COVER+GASKET
PVM4/6
10SIA78462:
OEM ALI SPA



4117786 COPERCHI
O C/GUARNIZIONE /
CAP WITH GASKET
10SIA78702:
OEM ALI SPA



4117920 COPERCHI
O C/GUARNIZIONE /
COVER WITH
GASKET



4217326 CAMPAN
A 90/130GR /
BELL 90/130 GR
KA025: OEM ALI
SPA



4117986 CAMPAN
A GR 190/230 /
BELL GR 190/230
OMKA027R0:
OEM ALI SPA



4217149 CAMPAN
A 260/300GR /
BELL GR 260/300
KA028R0:
OEM ALI SPA



4217023 COMPL.SU
PP.VASCA KG.30
SALDATO /
COMPLEMENT
SUPPORT WELDED
TANK 30 kilos
KE08410:
OEM ALI SPA



4217493 VASCHET
TA COMPLETA TG /
TG COMPLETE TANK
C0004T405:
MACAP SRL



4117941 COPPA
PER UGELLO /
BURNER LOWER
PART
31280100:
BERTO'S SPA



4117358 TUBO
D=200mm sp.5mm
L=205mm /
HOSE D=200mm
L=205mm
HOT DOG - SW1:
CB SRL



4217243 PROTEZIO
NE DI SICUREZZA /
PROTECTION
SECURITY
OKJ767:
ELECTROLUX
PROFESSIONAL
S.P.A.



S&P Cooking Catalogue 2017

4217191 PROTEZIO
NE ANTERIORE
TRASPARENTE (1)AS
/ FRONT
PROTECTION
TRANSPARENT (1)
AS

A1L4000:
OEM ALI SPA

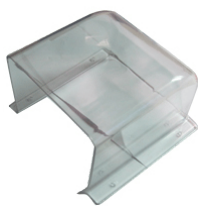

4117981 COLTELL
O BM/2 DOPPIA
FORATURA /
KNIFE BM/2
AH10200:
OEM ALI SPA



4217264 COPERTU
RA INTERNA
MECCANISMO
CHIUSURA /
DOOR HANDLE
INTERNAL COVER

LAR69010630:
LAINOX ALI SPA
LAR69010630:
OLIS DIVISIONE
DI ALI GROUP SPA



4217105 BRACCIO
CON MANOPOLA
COMPLETO
SWEDLINGHAUS
AF250GR /
ARM COMPLETE
WITH HANDLE
SWEDLINGHAUS
AF250GR



4117284 SPORTELL
O DIRITTO + FORI
VETRINA G50 /
SHOWCASE DOOR
G50

PRF0043: FABA SRL



4117442 PROTEZIO
NE AFFETTATRICE /
SLICER COVER
PRT0924: FABA SRL



4217494 CARTER
MICRO TG /
TG MICRO SWITCH
CARTER

C0007T401:
MACAP SRL



4117842 FIANCAT
A LAT.DX IN VEDRIL
SP4 /
LATERAL COVER
RIGHT

J4L0500:
OEM ALI SPA



4117428 RACCOGL
IGOCCE G2S /
DROP COLLECTOR

PACU800040:
MBM- EUROTEC SRL
- DIV. COOKING
SERVICE



4117844 FIANCAT
A LAT.SX in VEDRIL
SP4 /
LEFT LATERAL
COVER

J4L0600:
OEM ALI SPA



4217475 COPERCHI
O RULLO
TRASPARENTE BM/1-
2 /
ROLLER COVER
BM/1-2

AP00420:
OEM ALI SPA



DIMENSIONS
210X120mm

4217156 PARADIT
O IN PLEXIGLASS
275 FABA /
PAR RISE IN
PLEXIGLAS 275
FABA

PR0326: FABA SRL



4117935 ZAMPA
PRESSAMERCE IN
PLASTICA CELME
MOD.GPR GE 300 /
PLASTIC GRIP
CELME MOD. GPR
GE 300



4117525 COPRILA
MPADA
RETTANGOLARE
FORNO E77 /
LAMP COVER
RECTUANGULAR -
OVEN E77

AL040:
OEM ALI SPA
AL04000:
OEM ALI SPA

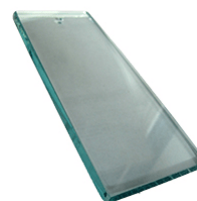

DIMENSIONS
153X63X8mm

S&P Cooking Catalogue 2017

4217508 ROMPIFIA
MMA BRUCIATORI
F.GAS /
FLAME ARRESTOR
GAS OVENS
KB61110:
OEM ALI SPA



DIMENSIONS
20X40mm

4217047 GR.CRUSC
OTTO FEMD023 /
INSTRUMENT PANEL
FEMD023
GRFOC00270:
MBM- EUROTEC SRL
- DIV. COOKING
SERVICE



4117434 LEVA /
LEVER
PR60650: FABA SRL



4217227 ADESIVO
PANNELLO
FRONTALE /
STICKER FRONT
PANEL
AM529: OEM ALI
SPA



4117919 RASCHIA
TORE /
SCRAPER
SL2228: FIMAR
S.P.A.



4217338 PANNELLO
O
ALLUMINIO+TASTIE
RA
POLICARBONATO
(HE21700) /
ALUMINIUM
CONTROL PANEL +
KEYBOARD
Polycarbonate (HE
21700
HE23100:
OEM ALI SPA



280X85mm

4217039 BACINELL
A CONTROPORTA /
BASIN COUNTER
DOOR
R69180180:
LAINOX ALI SPA
LAR69180180:
LAINOX ALI SPA



4217157 CORNICE
FR.COM.S 2000
MOD.(WFE43)V.N /
FRAME FR.COM.S
2000 MOD. (WFE43)
V.N
WFB4320:
OEM ALI SPA



4217040 SCARICO
BACINELLA PORTA /
DOOR TANK
DISCHARGE
LAR69180000:
OLIS DIVISIONE
DI ALI GROUP SPA
-
LAR69180000:
SILKO ALI SPA
LAR69180000:
LAINOX ALI SPA
R69180000:
LAINOX ALI SPA



4117851 IMBUTO
GR.200-250-
300(ZN056) /
FUNNEL GR200-250-
300 (ZN056)
AH05220:
OEM ALI SPA

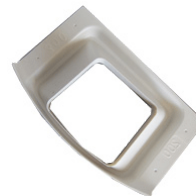

4117995 CREMAGL
IERA A5 /
CREMAGLIER A5
C0004M102:
MACAP SRL



4117847 IMBUTO
GRANDE AS SP 5,5 IN
ABS (ZN058) /
FUNNEL AS WIDTH
5,5 ABS (ZN058)
AH12920:
OEM ALI SPA



4117850 PROTEZ.B
ULBO INT.CAMERA
H+GAS /
PROBE PROTECTION
INTERNAL
CHAMBER
HAT9900:
OEM ALI SPA



4117912 IMBUTO
PICCOLO X KA009
GR.150 /
SMALL FUNNEL X
KA009 gr.150
AH04820:
OEM ALI SPA



S&P Cooking Catalogue 2017

4117849 SOSTEGNO
O SCIVOLO
AS/T(ZN056) /
SHOVEL SUPPORT
AS/T (ZN056)
AH05720:
OEM ALI SPA



4117996 INGRANA
GGIO A5 /
GEAR A5
C0004A514:
MACAP SRL



4217214 PIATTELL
O BM/1-BM/2
(A2M00) /
PLATE BM / BM-1/2
(A2M00)
KF02020:
OEM ALI SPA



4217031 ASSE
FRULLATORE L. 5 /
AXIS BLENDER L. 5
C0004F321:
MACAP SRL



4117238 PERNO
VALVOLA EUROSIT /
GAS TAP AXIS
8X6,5mm 34mm
33Q3480EX:
ANGELO PO
GRANDI CUCINE
SPA
33Q3481:
ANGELO PO
GRANDI CUCINE
SPA



4117966 PVM7
ALBERO COMPLETO
/
SHAFT PVM7
10SIA70055:
OEM ALI SPA



4217134 PERNO
VALVOLA EUROSIT
630 /
PIN VALVE EUROSIT
630
3051661:
ANGELO PO
GRANDI CUCINE
SPA



4117813 FUNGO
SPIRALE
CROM.KG.10(O1K17 /
SHAFT KG.10
KE06820:
OEM ALI SPA



4117470 PROLUNG
A /
EXTENSION
002131:
ELECTROLUX
PROFESSIONAL
S.P.A.



4146025

4117970 ALB.SPIR
ALE KG.60E/P
CROMATO /
HELIX SHAFT
KG.60E/P
KE33720:
OEM ALI SPA



4217531 "ALBERO
COMPLETO; T10/T15"
/
COMPLETE SHAFT
T10/T15
OKQ638:
ELECTROLUX
PROFESSIONAL
S.P.A.



A=40mm, B=17mm,
H=12mm, BEARING

4117854 SUPP.SPIR
.D.100X150
CR(O6K21) /
SUPPORT SPIRAL
D.100X150 CR
(O6K21)
KE08620:
OEM ALI SPA



4117533 ALBERO /
shaft
10SIA70051:
OEM ALI SPA



4217435 STUD -
LOCKING /
STUD - LOCKING
875265:
HOBART GmbH

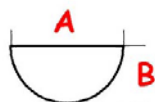

A=6mm, B=5mm

4117904 C.ALBERO
TRASC.SPIRALE
BM1/2 /
SHAFT BM1/2
KF03710:
OEM ALI SPA



S&P Cooking Catalogue 2017

4117837 GRUPPO
GIUNTI
MASCIO/FEMMINA
/
COUPLINGS M/F
RC091R0:
OEM ALI SPA



4117737 ALBERO
CALETT.SUP.L=150
KG.20 /
SHAFT L150 KG.20
KE00100:
OEM ALI SPA



4117476 PERNO
TRITACARNE
SIRMAN /
PIN MIXER SIRMAN



4117460 CONO
VENTURI
ALLUMINIO /
ROSETTE PIPE
0100256:
SILKO ALI SPA
SIRO100256:
SILKO ALI SPA



4117332 SUPPORT
O DISTANZIALE /
SPACER REST
6V-VDE-ECV1050-
ECV/SELF2076-EVF:
CB SRL



4117321 PERNO
FRESATO DX
PORTA-SCHIDIONE /
RIGHT SPIT-HOLDER
PIN
GPE/G: CB SRL



4117546 PROLUNG
A VALVOLA GAS /
KNOB ADAPTER
059305:
ELECTROLUX
PROFESSIONAL
S.P.A.

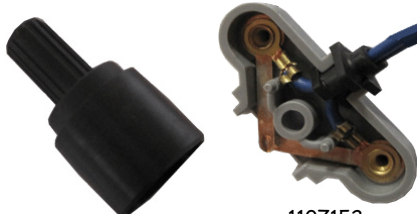

= 1107152

4117748 PROLUNG
A VALVOLA GAS /
GAS VALVE
EXTENSION
003391:
ELECTROLUX
PROFESSIONAL
S.P.A.



4117578 KIT
ACCOPIAMENTO
DITO SAMA /
COUPLING KIT DITO
SAMA
0D5220:
ELECTROLUX
PROFESSIONAL
S.P.A.



4217167 "ADATTA
TORE; FOR KNOB '
MERTIK '" /
ADAPTER; KNOB
FOR 'Mertik'
0C5400:
ELECTROLUX
PROFESSIONAL
S.P.A.



4117056 FLANGIA
CUCINA 6 FUOCHI
058773 /
FLANGE 058773
058773:
ELECTROLUX
PROFESSIONAL
S.P.A.



4217185 PIGNONE
Z15 /
PINION Z15
IMX25014:
MECNOSUD SRL



4217186 PIGNONE
Z29 /
PINION Z29
IMX25023:
MECNOSUD SRL



4217236 "PIGNONE
MOTORE .Z25
3/8""D.BM/2(S2K80)" /
STAINLESS STEEL
PINION Z25
3/8""D.BM/2(S2K80)
KF05000:
OEM ALI SPA



4117872 MRE
INGRANAGGIO Z.40 /
MRE GEAR Z40
50SBA73571:
OEM ALI SPA



4117873 MRE
INGRANAGGIO
DOPPIO Z.41/18 /
DOUBLE
GEAR MRE Z41/18
50SBA73572:
OEM ALI SPA



4117907 C.SUPP.V.
KG20/90F(KE117+I2K
50) /
GEAR G20/90F
(KE117+I2K50)
KE12010:
OEM ALI SPA



4117874 MRE
PIGNONE MOTORE
Z.13 /
MRE PINION FOR
MOTOR Z.13
50SBA73581:
OEM ALI SPA



4217144 INGRANA
GGIO NYLON 25
DENTI FIA BOSTON /
NYLON GEAR 25
TEETH FIA BOSTON



4217376 SERIE
INGRANAGGI
SFOGLIATRICE
IMPERIA /
GEARS SET FOR
SHEETER



4217177 DISTANZI
ALE VASCHETTA
GS/N /
DISTANCE PAN GS /
N
947:
ARISTARCO
KASTEL SPA



4117268 CUSCINET
TO /
BEARING
3151490:
ANGELO PO
GRANDI CUCINE
SPA



4117197 SUPPORT
O VASCETTA.
40/2000 /
CLOG FOR CONE
MOD. 40/2000
40101: CEADO SRL
PR40101: FABIA SRL



4117254 REGOLAT
ORE ARIA /
AIR REGULATOR
052116:
ELECTROLUX
PROFESSIONAL
S.P.A.



4117931 BRONZIN
A ø 20x16x19 mm /
BUSHING ø 20x16x19
mm
3665950:
FIMAR S.P.A.
3665950:
ANGELO PO
GRANDI CUCINE
SPA



4217431 ROLLER /
ROLLER
323743:
HOBART GmbH



4117213 BOCCOLA
REGOLAZIONE ARIA
/
AIR REGULATION
PIPE
MA1314700:
MARENO
INDUSTRIE ALI
SPA
MA1314700:
SILKO ALI SPA



4117882 BUSSOLA
AUTOL.15E7/21/27X2
2+3 /
BUSH
15E7/21/27X22+3
AE04400:
OEM ALI SPA



4117879 RUOTA
RULLO MM.50X40
VULKOFLEX /
WHEEL ROLLER
50X40MM
VULKOFLEX
AC07300:
OEM ALI SPA



4117736 BOCCOLA
BROCCIATA(CONG.A
LBERI) /
BUSH broached
(CONJUNCTION
TREES
KE04EX:
OEM ALI SPA
KE12500:
OEM ALI SPA
KE04: OEM ALI SPA



4117141 PIANO
VETROCERAMICA
BASE MEDIA
300X400MM /
MIDDLE BASE
BAKED CLAY GLASS
SURFACE
300X400MM
PR13096: FAB A SRL

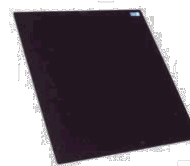

DIMENSIONS
300X400mm

4217116 PVM25
PULEGGIA MOTRICE
MULTIR. /
PVM25 DRIVING
PULLEY MULTY
LINE
50LUA74101:
OEM ALI SPA



4117082 PIANO
VETROCERAMICA
BASE DOPPIA
300X545MM /
DOUBLE BASE
BAKED CLAY GLASS
SURFACE
300X545mm
PR13004: FAB A SRL



DIMENSIONS
300X545mm

4117492 REGOLAT
ORE ARIA /
MIXING PIPE
0100257:
SILKO ALI SPA
SIRO100257:
SILKO ALI SPA



4217229 VETRO
SUPERIORE PIASTRA
DOPPIA RIGATA
205X235MM /
GLASS TOP PLATE
DOUBLE STRIPED
205X235MM
CO4460: FIMAR
S.P.A.



DIMENSIONS
235X205mm

4117101 PIANO
SUPERIORE
VETROCERAMICA
LISCIO 300X240MM /
SMOOTH BAKED
CLAY GLASS UPPER
SURFACE
300X240MM
PR13026: FAB A SRL



DIMENSIONS
300X240mm

4217507 PIANO
VETROCERAMICA
PICCOLO RIGATO
250X250mm /
SMALL RULED
BAKED CLAY GLASS
SURFACE
250X250mm
XRPV11: VEMA SRL

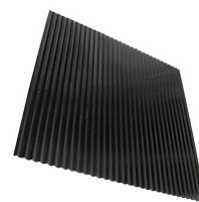

DIMENSIONS
250X250mm

4117130 PIANO
SUPERIORE
VETROCERAMICA
RIGATO 300X240MM
/
RULED BAKED
CLAY GLASS UPPER
SURFACE
300X240MM
PR13023: FAB A SRL

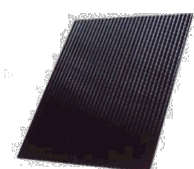

DIMENSIONS
300X240mm

4217265 VETRO
PIASTRA INDUZIONE
PFD27 /
GLASS PLATE
INDUCTION PFD 27
CO0645: FIMAR
S.P.A.

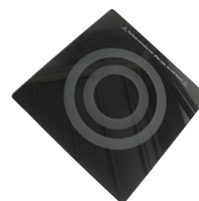

4117747 PIANO
VETROCERAMICA
BASE SINGOLA
300X270MM /
SINGLE BASE
BAKED CLAY GLASS
SURFACE
300X270MM
PR13003: FAB A SRL



DIMENSIONS
300X270mm

4217525 VETRO
ESTERNO CON
SUPPORTO, FASCE
INFERIORI E
SUPERIORI PER KF
723 /
KF 723 EXTERNAL
GLASS WITH
SUPPORT, BANDS
LOWER AND HIGHER
21000250:
TECNOEKA SRL

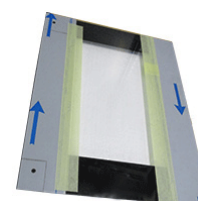
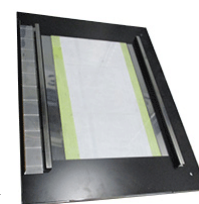

DIMENSIONS
585X450mm

4117522 PIANO
SUPERIORE
VETROCERAMICA
MEDIO LISCIO
300X370MM /
SMOOTH MIDDLE
BASE BAKED CLAY
GLASS SURFACE
300X370MM
PR13097: FAB A SRL



DIMENSIONS
300X370mm

4117951 PIETRA
REFRATTARIA
628X606X14 F.430 DS
/
REFRACTORY
STONE 628X606X14
F.430 DS
AL33100:
OEM ALI SPA



4117697 PIETRA
622X606X25 22-66-
MF4/8 /
REFRACTORY
STONE 622X606X25
22-66- MF4/8
AL15100:
OEM ALI SPA

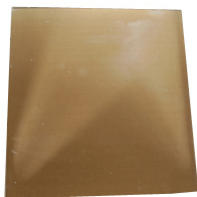

4117828 PIETRA
REFR.910X455X19
F.99 /
REFRACTORY
STONE 910X455X19
F.99
AL17900:
OEM ALI SPA



4117846 PIETRA
REFR.913X606X19
F.69-96 /
REFRACTORY
STONE 913X606X19
F.69-96
AL18200:
OEM ALI SPA



4117312 MATTONE
REFRATTARIO
CURVO /
FIRE-BRICK
GIRARROSTI G12P-
G20P:
CB SRL



4117313 MATTONE
REFRATTARIO
DRITTO /
FIRE-BRICK
GIRARROSTI GAS
20/48P:
CB SRL



4117805 VETRO
P.CERAM.MM.131X41
0 SP.4 /
GLASS MM131X410
SP.4
AL27600:
OEM ALI SPA



4217103 VETRO
P.CERAM.MM.836X11
0 SP.4 /
CERAMIC GLASS
MM.836X110 SP.4
AL31000:
OEM ALI SPA



4117336 RETE DI
PROTEZIONE GYROS
CB 1B 10 /
PROTECTION NET
FOR GYROS CB 1B 10
GYROS 1B/10: CB
SRL

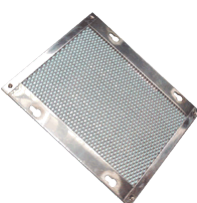

4117337 RETE DI
PROTEZIONE GYROS
CB 2B 30 /
PROTECTION NET
FOR GYROS CB 2B 30
GYROS 2B/30: CB
SRL



4117393 GRIGLIAT
O COTTURA CARNE
I-80 /
14080031: CB SRL

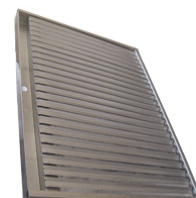

4117257 PIASTRA
RAD.RIG.S.GAS /
GAS PLATE
RTC800024:
MBM- EUROTEC SRL
- DIV. COOKING
SERVICE
A800012:
MBM- EUROTEC SRL
- DIV. COOKING
SERVICE
RTC800035:
MBM- EUROTEC SRL
- DIV. COOKING
SERVICE

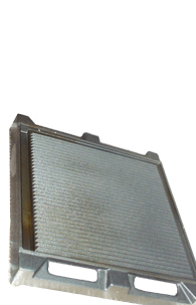

4217273 PIASTRA
RIGATA 2/F 90
NORMALE /
GROOVED PLATE 2 /
F 90 NORMAL
BN6A002600:
OLIS DIVISIONE
DI ALI GROUP SPA
-



DIMENSIONS
680X400 mm

4117052 BACINELL
A BRUCIATORE D. 83
052102 /
COLLECTING TRAY
D. 83 052102
052102:
ELECTROLUX
PROFESSIONAL
S.P.A.

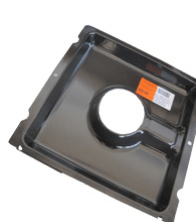

4117322 CUSCINET
TO 6001-Z/C3 /
BEARING 6001-Z/C3
GP E/G DX: CB SRL

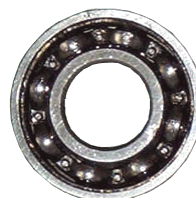

4117324 CUSCINET
TO 6204-Z /
BEARING 6204-Z
GPE-G SX: CB SRL



4117325 CUSCINET
TO 6205-Z /
BEARING 6205-Z
GPE-G SX: CB SRL



4217532 "CUSCINE
TTO: 6205 2RS" /
BEARING 6205 2RS
OKQ394:
ELECTROLUX
PROFESSIONAL
S.P.A.

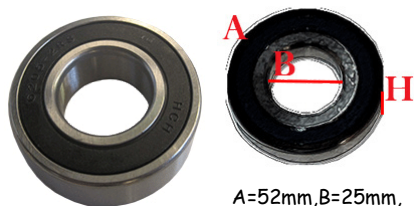

A=52mm, B=25mm,
H=15mm

4117930 CUSCINET
TO RADIALE /
BEARING 6302 DDU
NSK
36F0090:
FIMAR S.P.A.
36F0090:
ANGELO PO
GRANDI CUCINE
SPA



A = 42mm , B= 15mm,
H= 13mm

4217071 CUSCINET
TO /
BEARING
SLO118: FIMAR
S.P.A.



4117856 CUSCINET
TO SKF 6205 2Z
KG30-50 /
BEARING SKF 6205
2Z KG30-50
AB07200:
OEM ALI SPA

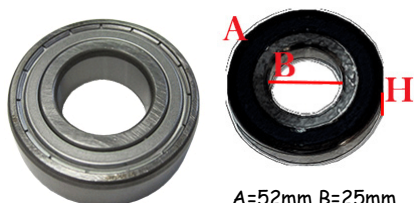

A=52mm, B=25mm,
H=15mm

4117908 CUSCINET
TO 6005 2Z KG20/90
SKF /
DEEP-GROOVE BALL
BEARING 6005 2Z
KG20/90 SKF
AB10900:
OEM ALI SPA

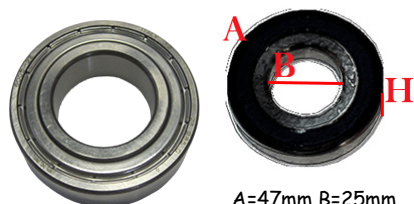

A=47mm, B=25mm,
H=12mm

4117909 CUSCINET
TO SKF 6204 2Z KG.20
/
SKF BEARING 6204
2Z kg.20
AB04800:
OEM ALI SPA

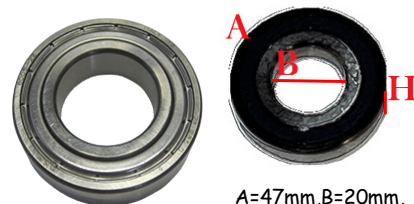

A=47mm, B=20mm,
H=14mm

4117943 CUSCINET
TO ZKL 6005 2RS
S.SPIR /
BEARING ZKL 6005
2RS
AB11400:
OEM ALI SPA

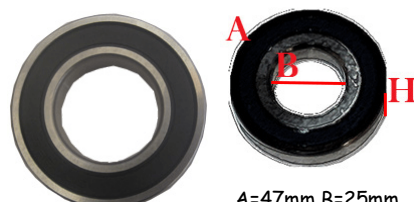

A=47mm, B=25mm,
H=12mm

4117544 KIT
CUSCINETTI
IMPASTATRICE /
BUSH KIT
R202T: OEM ALI
SPA
KE128R0:
OEM ALI SPA



4117897 TUBO
VENTURI /
TUBE VENTURI
770324790:
GICO SPA



4117900 CONDUTT
URA PILOTA
POSTERIORE /
REAR PILOT PIPE
770339860:
GICO SPA



4217426 "KIT DI
TENUTA ALBERO;
PER TBS" /
SEALS KIT FOR TBS
OD0469:
ELECTROLUX
PROFESSIONAL
S.P.A.



GUARNIZIONE
75X17X1mm 4 fori,
ANELLITENUTA
40X17X7mm

4217119 ANELLO
DI TENUTA 25X47X10
/
SEAL RING 25X47X10
50IAA71199:
OEM ALI SPA



4117923 COPPETT
A /
Cupping
OD0743:
ELECTROLUX
PROFESSIONAL
S.P.A.



4117937 TAMPONE
COMPLETO INSACC.
AMB RL 6,5 /
COMPLETE PAD FOR
SAUSAGE-FILTER
AMB RL 6,5



4117421 GUARNIZI
ONE
PORTALAMPADA /
LAMP HOLDER
GASKET
002626:
ELECTROLUX
PROFESSIONAL
S.P.A.



4217043 TAMPONE
INSACCATRICE AMB
MOD RL15 IDR V /
FILLING PLUG MOD
AMB RL15 IDR V



4117944 GIUNTO
MASCHIO F/30
GR.R.SUP/I /
MALE COUPLING
F/30
KF07600:
OEM ALI SPA



4217131 PESTELLO
/
PESTLE
OKI992:
ELECTROLUX
PROFESSIONAL
S.P.A.



4117945 GIUNTO
FEMM.F/30 GR.RULLI
S/L /
COUPLING FEMALE
F/30
KF07500:
OEM ALI SPA



4117963 TV73-99
PESTELLO MOD.32 /
RAMMER TV73-99
MOD. 32
50SCA75305:
OEM ALI SPA



4117952 VOLANTI
NO PER
INSACCATRICE AMB
/
FLIER FOR
SAUSAGE-FILTER
AMB



4117993 TV98
PESTELLO /
TV98 PESTLE
50NAA78050:
OEM ALI SPA



4117984 DIS.SUP.K
G20/90 F-R-VE
Z(I2K37 /
UPPER SPACER
KG20/90 F-R-VE
Z(I2K37
AE14120:
OEM ALI SPA



4217161 PESTELLO
VUOTO MOD. 22 Ø
50X130 mm. /
TAMPER EMPTY
MOD. 22 mm Ø
50X130.



4217054 CONTROF
LANGIA D INTERNO
160mm D ESTERNO
200mm /
COUNTERFLANGE D.
INTERNAL 160mm D.
EXTERNAL 200mm



4217383 PESTELLO
VUOTO MOD. 32 Ø
50X150 mm. /
PESTLE EMPTY
MOD. 32 mm Ø
50X150



4217405 PESTELLO
/
PESTLE
50NAA7850:
OEM ALI SPA



4217305 RULLO
CILINDRO
INFERIORE
F/30+F/30A-F/30T /
ROLLER LOWER
CYLINDER F / 30 + F /
F-30A / 30 T
RC052RO:
OEM ALI SPA



4217077 RULLO
ECCENTRICO
INFERIORE F30-F30A-
F30T ø 48x295 mm /
ECCENTRIC ROLLER
LOWER F30-F30A-
F30T ø 48x295 mm
RC048RO:
OEM ALI SPA



4117617 SERIE
IMBUTI PER
INSACCATRICE
TRESPADE /
FUNNELS FOR
BAGGING TRESPADE



4117015 ANELLO
DI TENUTA AF ATA
4364 /
GASKET FOR WASH
ARM PTFE
4364: A.T.A. SRL



4117323 ANELLO
SEEGER INT7437 28 /
SEEGER RING 7437 28
GP E-G- GRIGLIE:
CB SRL



4117361 ANELLO
SEEGER EST.742525 /
SEEGER RING 742525
03041051: CB SRL



4117333 TUBO
MANIGLIA 1050 /
HANDLE HOSE 1050
ECV/SELF 1050:
CB SRL



4117334 TUBO
MANIGLIA 2076 /
HANDLE HOSE 2076
ECV/SELF 2076:
CB SRL



4117359 RULLO
CON CORONA CB
W12/5 - W18/7 /
ROLLER WITH
CROWN CB W12/5-
W18/7
W12/5 - W18/7:
CB SRL



4117360 RULLO
CON CORONA CB
W24/7-W32/9 /
ROLLER WITH
CROWN CB W24/7-
W32/9
W24/7 -W32/9:
CB SRL



4117349 ASTA
CENTRALE GYROS
IR9/60 CB /
CENTRAL ROD FOR
GYROS IR9/60 CB
GYROS IR3/20:
CB SRL



4117356 PUNZONE
TEFLONATO HOT
DOG -TP /
PUNCH FOR HOT-
DOG
HOT DOG- TP: CB
SRL



4217420 TUBO
VENTURI
LAVORATO /
VENTURI TUBE
770328740:
GICO SPA

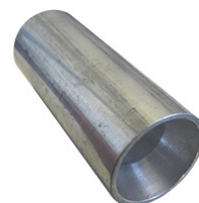

L=70mm

4117341 PERNO
MANIGLIA
COMPLETO GYROS
1B 2B /
COMPLETE CRANK
PIN FOR GYROS 1B
2B
GYROS 1B-2B: CB
SRL



S&P Cooking Catalogue 2017

4117342 PERNO
MANIGLIA
COMPLETE GYROS
3B 4B /
COMPLETE CRANK
PIN FOR GYROS 3B
4B
GYROS 3B/50-
4B/100:
CB SRL



4217154 TIRANTE
COPRILAMA FABA
275 /
BLADE TIE FABA 275
PRT0897EX:
FABA SRL
PRT0817: FABA SRL



4217014 TIRANTE
AFFETTATRICE
NOAW 350TC10 /
TIE SLICER NOAW
350TC10



4117982 VOLANT.F
ISS.P.TEMP.ZP/22
M6X15 /
THUMB SCREW
ZP/22 M6X15
AC03000:
OEM ALI SPA



4117475 MANOPOL
A FERMABOCCA
TRITACARNE
SIRMAN /
KNOB MIXER
SIRMAN



4117877 POMELLO
CAMINO FORNO
PL/50 M10 /
KNOB
AC06500:
OEM ALI SPA



4117318 SCHIDION
E SENZA
FORCHETTE /
SPIT WITHOUT FORK
G8/12P-G20P
E20P/S5: CB SRL



4117320 SCHIDION
E SENZA
FORCHETTE 24-96P /
SPIT WITHOUT
FORK 24-96P
G24/96P-E30P/S5:
CB SRL



4117345 ASTA
CENTRALE GYROS
3B50 /
CENTRAL ROD FOR
GYROS 3B50
GYROS 3B/50: CB
SRL



4117214 SUPPORT
O SPIA /
WARNING LIGHT
REST
35R1460:
ANGELO PO
GRANDI CUCINE
SPA

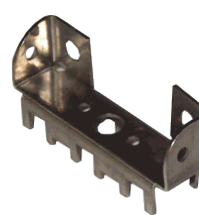

4117326 FORCHET
TA CENTRALE /
CENTRAL FORK
G E/G: CB SRL



4117327 FORCHET
TA TERMINALE
C/VITE /
END FORK WITH
SCREW
G E/G: CB SRL

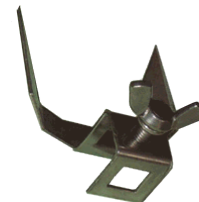

4117282 BASETTA
SERRATURA /
LOCK BASIS
36M1570:
ANGELO PO
GRANDI CUCINE
SPA



DIMENSIONS
110X33mmX10H

4117209 STAFFA
INF. COMPLETA
A.PO 30T6230 /
COMPLETE LOWER
HING A.PO 30T6230
30T6230:
ANGELO PO
GRANDI CUCINE
SPA



S&P Cooking Catalogue 2017

4117175 PROFILO
"L" COMPL. A.PO
35T2590 /
""L"" PROFILE A.PO
35T2590"
30T2590:
ANGELO PO
GRANDI CUCINE
SPA



4117310 SUPPORT
O SX PILOTA /
LEFT PILOT
SUPPORT
GRIGLIA GC-I:
CB SRL

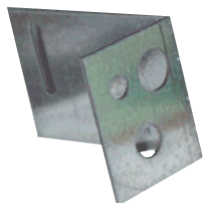

4117311 SUPPORT
O DX PILOTA /
RIGHT PILOT
SUPPORT
GRIGLIE GC-I: CB
SRL



4117340 SCORREV
OLE SUPERIORE
GYROS CB /
SUP. GUIDE FOR
GYROS CB
GYROS GAS ALL
MODEL: CB SRL



4217132 STAFFA /
BRACKET
051905:
ELECTROLUX
PROFESSIONAL
S.P.A.



4117998 "COPERTU
RA; UPPER" /
COVER UPPER
0D5226:
ELECTROLUX
PROFESSIONAL
S.P.A.



4217362 REGOLAZI
ONE ARIA
BRUCIATORE GW /
AIR ADJUSTER
00038562:
ELFRAMO SPA



4117083 FRIZIONE
IN OTTONE PIASTRE
FABA /
BRASS RUBBING
FOR PLATES FABA
69000696:
RANCILIO SPA
PR10014: FABA SRL



4117777 6033010083
SOPORTE BISAGRA
DB-516 INF,IZD /
SUPPORT
12036932:
FAGOR
INDUSTRIALE
S.R.L.

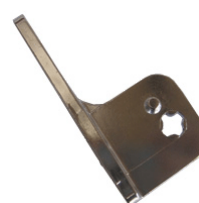

4117673 AGGANCI
O NASELLO
MANIGLIA /
DOORHANDLE
STRIKE
R18200940:
LAINOX ALI SPA
LAR18200940:
LAINOX ALI SPA



4217020 ANGOLAR
E REG.MOLLA
4/8/5/10 TR /
ANGULAR
ADJUSTMENT
SPRING TR 4/8/5/10
0MHAT0400:
OEM ALI SPA
HAT0410:
OEM ALI SPA



4217530 LAMA
DISCO FETTE TV3 /
DISC BLADE TV3
50SEA78692:
OEM ALI SPA



4217315 PULEGGIA
MOT.PLAST.P40+40T
+30 /
PULLEY
MOT.PLAST.P 40 +
40E + 30
RC474RO:
OEM ALI SPA



4217316 PULEGGIA
RIDUTTORE
PLASTICA F/30 /
REDUCING PLASTIC
PULLEY F30
RC480RO:
OEM ALI SPA



4117277 SUPPORTO ANELLO / FLANGE FOR MOTOR SHAFT
33Q6320:
ANGELO PO
GRANDI CUCINE SPA



Øi=14mm, H=10mm,
 Øe=58mm

4217233 FLANGIA GUARNIZIONE MOTORE / FLANGE GASKET MOTOR
LAR58003860:
LAINOX ALI SPA



4217121 PVM-PLP32 PULEGGIA CONDOTTA TN / PVM-PLP32 DRIVEN PULLEY TN
50LUA78172:
OEM ALI SPA



4217120 PVM12 DISCHETTO DI COPERTURA / PVM12 DISK COVER
50HAA74072:
OEM ALI SPA

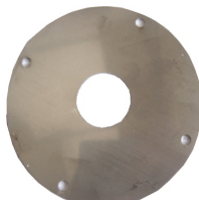

4217412 BASE VASCA / BASIC TANK
35NAA73756:
OEM ALI SPA



4217142 SCARICO CP71-CP91 / DISCHARGE CP71-CP91
R61191: ILSA SPA



4217421 ASSIEME GUIDA VENTURI / GUIDE FOR VENTURI
770107150: GICO SPA



4217143 SUPPORTO TRASMISSIONE BM/2+BRONZINA / SUPPORT TRANSMISSION BMW / 2 + BEARING
KF11010:
OEM ALI SPA



4117081 SPATOLA IN LEGNO PER CREPIERES / WOOD SPATULA FOR CREPIERES
PR30013: FABA SRL

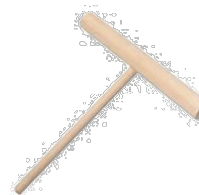

4117090 SPAZZOLA A PULIZIA PIASTRE / PLATES CLEANING BRUSH
PR10017: FABA SRL



4117080 SPATOLA IN ACCIAIO PER CREPIERES / STEEL SPATULA FOR CREPIERES
PR30012: FABA SRL



4117113 RASCHIETTO X PIASTRA VETROCERAMICA / SCRAPER FOR BAKED CLAY GLASS PLATE
PR13049: FABA SRL



4117505 RASCHIETTO PER PIASTRA CROMATO / SCRAPER FOR PLATE



4117890 RICAMBI O PER SPAZZOLONE / SCRUBBING BRUSH
OMAZO68R0:
OEM ALI SPA



4117149 CUCCHIAIO DOSATORE / DOSING SPOON
38120004:
RANCILIO SPA



4217193 CONDUIT
URA PILOTA CUCINA
S70 /
PIPELINE PILOT
KITCHEN S70
K25591: A.T.A. SRL



4217194 CONDUIT
URA PILOTA FUOCHI
POSTERIORI S70 /
PIPELINE PILOT
BURNER REAR S70
K25585: A.T.A. SRL



4217195 CONDUIT
URA PILOTA
ANTERIORE S70 /
PIPELINE PILOT
FRONT S70
K25586: A.T.A. SRL



4217542 CONDUIT
URA PER
BRUCIAORE PILOTA
POSTERIORE /
PIPELINE PILOT
BURNER REAR
005561:
ELECTROLUX
PROFESSIONAL
S.P.A.



Ø=4X2,8mm

4117899 CONDUIT
URA BRUCIATORE
ANTERIORE SX /
PIPELINE FOR
FRONT BURNER
290338970:
GICO SPA



4117666 GRUPPO
BRUCIATORE
PILOTA KIT /
GROUP PILOT
BURNER KIT
0C3652:
ELECTROLUX
PROFESSIONAL
S.P.A.



4117488 PORTAUG
ELLO BARON /
NOOZLE HOLDER
BN41826920222:
OLIS DIVISIONE
DI ALI GROUP SPA
-



4117548 PLAMPAD
A FCV.77222U10223 /
BULB SOCKET FOR
LIGHTING DEVICE
FOR OVEN
RTFOC00036:
MBM- EUROTEC SRL
- DIV. COOKING
SERVICE



4217461 QUADRO
EB12 9 KW /
COMPLETE
CONTROL PANEL
EB12 9 KW
00033022:
ELFRAMO SPA

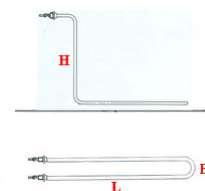

B=220mm, H=250mm,
L=270mm

4217459 QUADRO
EM20 16,5KW 400V
RICAMBI /
CONTROL PANEL
ASSEMBLY EM20
16,5KW 400V
00033032:
ELFRAMO SPA

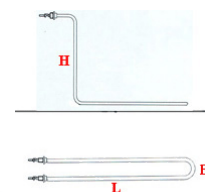

B=210mm, H=260mm,
L=375mm

4217460 "GUAINA
TERMOSTATI M3/4"
RICAMBI" /
SHEATH FOR
THERMOSTAT M3/4
00030500:
ELFRAMO SPA



4217122 SOSTEGN
O ALBERO /
PIN SUPPORT
0D0341:
ELECTROLUX
PROFESSIONAL
S.P.A.



4117215 PROTEZIO
NE V, EUROST /
GASKET FOR KNOB
ADAPTER
3152280:
ANGELO PO
GRANDI CUCINE
SPA

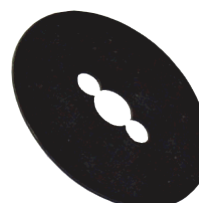

4117216 PROTEZIO
NE RUBINETTO /
COCK GASKET
3152250:
ANGELO PO
GRANDI CUCINE
SPA



S&P Cooking Catalogue 2017

4117263 FLANGIA
BASE /
FLANGE
36D0360:
ANGELO PO
GRANDI CUCINE
SPA



4117972 CHIAVETT
A AD INCASTRO
6X6X25 /
SLOT NUT 6X6X25
MD06100:
OEM ALI SPA



4117269 STAFFA
INFERIORE
COMPLETA /
COMPLETE LOWER
STIRRUP
30T5810:
ANGELO PO
GRANDI CUCINE
SPA



4117976 TELO
ANTIADERENTE -
VENDITA AL METRO
/
COVER NON STICK -
SALE AT METRO
OMALO85RO:
OEM ALI SPA



DIMENSIONS
1000X700mm

4117362 BOCCOLA
MASCIO STEATITE
/
MASCULINE
INSULATOR
WUSTEL -VR-EV:
CB SRL



4117801 TAPPETO
NT NAB-8EIW
100X888 C. /
CARPET NT NAB-
8EIW 100X888
APO0300:
OEM ALI SPA



4117363 BOCCOLA
FEMMINA STEATITE
/
FEMALE
INSULATING
WUSTEL - VR-EV:
CB SRL



4117042 MECCANI
SMO FORNO CONV.
056551 /
LATCH PART 056551
056551:
ELECTROLUX
PROFESSIONAL
S.P.A.



4117328 PORTAST
ARTER /
SWITCH-HOLTER
ECV/SELF-EVF-
STL60: CB SRL



4117373 ZOCCOLO
EST.SER.P.FCV.02094
5 /
LARCH PIECE
CONSOLE
(UPPER/LOWER)
RTFOC00005:
MBM- EUROTEC SRL
- DIV. COOKING
SERVICE



4217173 SUPPORT
O TRASMISSIONE
BM/2(ZFB01) /
SUPPORT
TRANSMISSION BM /
2 (ZFB01)
KF03920:
OEM ALI SPA



4117374 ZOCCOLO
CENT.SER.P.FCV.0209
44 /
GEAR CONSOLE
RTFOC000057:
MBM- EUROTEC SRL
- DIV. COOKING
SERVICE



4217238 "GIUNTO
CATENA 3/8"
DOPPIA" /
DOUBLE CHAIN
JOINT 3/8
KE00800:
OEM ALI SPA



4117375 GANCIO
FISSO
SER.P.FCV.010218 /
LOCK HOOK
P.FCV.010218
RTFOC00009:
MBM- EUROTEC SRL
- DIV. COOKING
SERVICE



S&P Cooking Catalogue 2017

4117072 EROGATO
RE PENTOLE /
POT DISPENSER
MA450000:
MARENO
INDUSTRIE ALI
SPA
MA450000:
SILKO ALI SPA



4117264 SUPPORT
O BRUCIATORE D.30
APO /
BURNER SUPPORT D.
30 A.PO
36D1230:
ANGELO PO
GRANDI CUCINE
SPA



4117114 GRUPPO
BOCCHETTA
SERRATURA /
DOOR LOCK
6300420:
ANGELO PO
GRANDI CUCINE
SPA

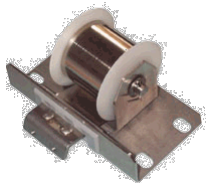

4117270 CONNETT
ORE 10 POS. /
JOINT 10 POS.
32D0140:
ANGELO PO
GRANDI CUCINE
SPA



4117179 CAPPUCCI
O LABIRINTO /
CAP
20510: CEADO SRL
PR20510: FABA SRL



4117330 REATTOR
E 230V TL14-25 /
REACTOR 230V TL14-
25
ECV1050-ECVSELF
2076-EVF2-EVF80-
EVF630: CB SRL



4217007 GRUPPO
REGOLAZIONE P/30-
POS.06 /
GROUP ADJUSTING
P/30-POS.06
RC058R0:
OEM ALI SPA



4117331 REATTOR
E 230V TL36-40 /
BALLAST 230V TL36-
40
ECV7SELF-EVF3-
EVF116-EVF970:
CB SRL



4217019 CALOTTA
MOTORE /
MOTOR COVER
F2416:
FAMA INDUSTRIE
SRL



4217112 MORSETTI
ERA DI
DERIVAZIONE /
TERMINAL
JUNCTION
MOR006:
GARBIN
INDUSTRIES SRL



4217096 R72501300
0 CONJUNTO
CORONA TAPA** /
R725013000 CORONA
TOP SET
12020501:
FAGOR
INDUSTRIALE
S.R.L.



4117830 SPAZZOL
A X MOTORE KD086 /
MOTOR BRUSH
KD086
E534100:
OEM ALI SPA



4117185 SUPPORT
O XPIANO COTTURA
A.PO /
SUPPORT FOR
COOKING PLANE
A.PO
36D0070:
ANGELO PO
GRANDI CUCINE
SPA

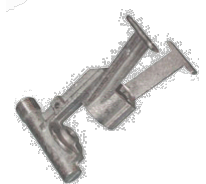

4217230 SUPPORT
O /
SUPPORT
SA1002: FIMAR
S.P.A.



S&P Cooking Catalogue 2017

4217210 GOMITO
VENTURI
BRUCIATORE SR
(ARC) /
ELBOW VENTURI
BURNER SR (ARC)
532004800:
LOTUS SPA



4117536 GRIGLIA /
GRILL
005932:
ELECTROLUX
PROFESSIONAL
S.P.A.



4217042 COMPL.B
USSOLA
SP.(KE080)KG.30 /
BUSHING SP. (KE080)
30 kilos
KE15210:
OEM ALI SPA



4117290 APPOGGI
A PINZE P3/P6 /
TOASTER PLIERS
GRILL P3/P6
PR425/1: FABA SRL

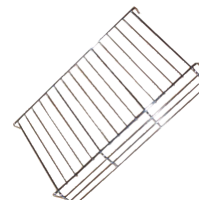

4117297 TAPPO IN-
OUT EUROSIT 3/8" /
CAP FOR VALVE
EUROSIT
056009:
ELECTROLUX
PROFESSIONAL
S.P.A.



4117561 GRIGLIA
SOTTOCESTELLO
FRIGGITRICE 18LT /
COATING FILTER
18LT
290203850 18LT:
GICO SPA



4217333 TAPPO
EUROSIT (120) /
EUROSIT VALVE
CAP



4217288 GRIGLIA
SUPERIORE
CESTELLO GF47
325x270 mm /
MESH FALSE
BOTTOM COMPLETE
325x270 mm
RTC700448:
MBM- EUROTEC SRL
- DIV. COOKING
SERVICE



DIMENSIONS
325X270 mm

4117563 SUPPORT
O CESTELLI /
BASKET REST
36A3500:
ANGELO PO
GRANDI CUCINE
SPA



4117335 PORTAUG
ELLO GYROS A GAS
CB /
NOZZLE FOR GAS
GYROS CB
GYROS: CB SRL



4217169 GRIGLIA
INFERIORE
CROMATA X FORNO
/
GRILLE CHROME
LOWER OVEN
619:
ARISTARCO
KASTEL SPA



4117348 COPIGLIA
D.3mm CB /
PIN D.3mm CB
GIRARROSTI GAS-
ELETTRICI-GYROS:
CB SRL



4217170 PROTEZIO
NE CROMATA PER
RESISTENZA .
FORNO /
PROTECTION
CHROME HEATING
ELEMENT. OVEN
608:
ARISTARCO
KASTEL SPA

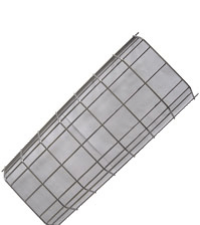

4117538 PISTONE
PER RUBINETTO /
PISTON FOR COCK
2280014802:
UGOLINI SPA



S&P Cooking Catalogue 2017

4117559 GR.REGOL
ATORE PRESSIONE
FCV /
PRESSURE
CONTROLLER
SETTING RANGE 0-
1BAR WITH
MANOMETER
GRFOC00274:
MBM- EUROTEC SRL
- DIV. COOKING
SERVICE



4217430 REPLACE
MENT KIT FOR CAP /
REPLACEMENT KIT
FOR CAP
77553050:
HOBART GmbH



4117686 LAMA Z14
/
BLADE Z14
1405012:
ORANGE SRL
ZUMMO ITALIA
ARIO S.R.L.

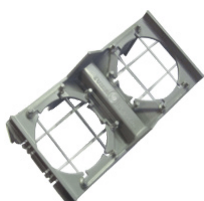

4217506 GUARNIZ.
BRUCIATORE TLVG
SP.3 /
BURNER GASKET
TLVG
AD27700:
OEM ALI SPA



DIMENSIONS
150X150X3mm

4117936 KIT ASTA
MICRO /
MICRO ROD



4217515 ATTUATO
RE / A
CTUATOR



4117977 CORNICE
FISSAGGIO
GUARNIZIONE
PORTA FORNO S7/9 /
FRAME FOR DOOR
SEAL
814811:
OFFCAR THE GREAT
COOKING S.R.L.



4217535 TENDEUR
EQUIPE T10/T15S /
TENDEUR EQUIPE
T10/T15S
OD0179:
ELECTROLUX
PROFESSIONAL
S.P.A.



4217109 CHIUSUR
A MAGNETICA
DELLA PORTA /
MAGNETIC CLOSING
DOOR
32583800:
BERTO'S SPA



4127039 RUBINETT
O MINISFERA FF 1/4"
D.8 /
"MINIBALL COCK FF
1/4" D.8"



4217160 "RIDUTTO
RE PORTATA; KIT
4PCS" /
FLOW REDUCER KIT
4 PCS
OC6375:
ELECTROLUX
PROFESSIONAL
S.P.A.



4127008 RUBINETT
O MINISFERA FF3/8
D. 8 /
MINIBALL COCK
FF3/8 D.8

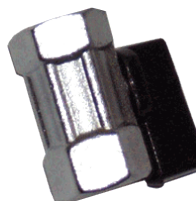

4217384 ANELLO
IN ELASTOMETRO -
24-32 KG.20 /
RING ELASTOMER -
24-32 kg.20
KE10800:
OEM ALI SPA



4127088 RUBINETT
O MINISFERA FF 1/2 /
MINIBALL COCK
FF1/2
1031400300:
MARENO
INDUSTRIE ALI
SPA
MA1031400300:
SILKO ALI SPA



4127089 RUBINETT
O MINISFERA M 3/4 F
3/4 /
MINIBALL COCK M
3/4 F3/4



4127014 RUBINETT
O ADDOLCITORE AD
/
WATER-SOFTNER
COCK AD



= 2101317

4127123 RUBINETT
O ADDOLCITORE
3/8" F /
"WATER-SOFTNER
TAP 3/8" F"



2101378

4127122 RUBINETT
O ADDOLCITORE 3/8"
M(V) /
"WATER-SOFTNER
TAP 3/8" M(V)"



2101378

4127142 RUBINETT
O ADDOLCITORE
3/4" M /
WATER SOFTNER
TAP 3/4" M



= 2101379

4127057 RUBINETT
O A SFERA C/S A.PO /
BALL COCK C/S A.PO
33D0853:
ANGELO PO
GRANDI CUCINE
SPA

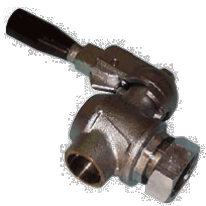

4127058 VALVOLA
SFERA FF A.PO /
BALL VALVE FF
A.PO
33D0170:
ANGELO PO
GRANDI CUCINE
SPA



4127059 VALVOLA
SFERA MF A.PO /
BALL VALVE MF
A.PO
33D0890:
ANGELO PO
GRANDI CUCINE



SPA

4127060 VALVOLA
A SFERA C/OR A.PO /
BALL VALVE C/OR
A.PO
33D1760:
ANGELO PO
GRANDI CUCINE
SPA



4127223 "VALVOL
A DI SCARICO; 3/4' X
1" /
DRAIN VALVE 3/4' X
1"
005919:
ELECTROLUX
PROFESSIONAL
S.P.A.



4127091 RUBINETT
O SCARICO OLIO
3/4" EF6BM /
"OIL DRAIN COCK
3/4" EF6BM"
161874:
ELETTROBAR
DIVISIONE DELLA
EUROTEC SRL
161874:
MBM- EUROTEC SRL
- DIV. COOKING
SERVICE



4127035 RUBINETT
O SCARICO OLIO /
OIL DRAIN COCK
PR70014: FABA SRL

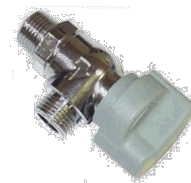

4127099 RUBINETT
O - RS/18 ATTACCO
3/4" /
COCK - RS/18
*: MBM- EUROTEC
SRL - DIV.
COOKING SERVICE
720008ex:

ELETTROBAR
DIVISIONE DELLA
EUROTEC SRL
0C2669:
ELECTROLUX
PROFESSIONAL
S.P.A.
3072720:
ANGELO PO
GRANDI CUCINE
SPA
RTC600211:
MBM- EUROTEC SRL
- DIV. COOKING
SERVICE



S&P Cooking Catalogue 2017

4127042 VALVOLA
A SFERA A.P.O
33D1770 /
BALL VALVE A.P.O
33D1770
33D1770:
ANGELO PO
GRANDI CUCINE
SPA



4127061 RUBINETT
O 3/8" A.P.O /
"TAP3/8" A.P.O"
33D0590:
ANGELO PO
GRANDI CUCINE
SPA



4127063 RUBINETT
O 1/2 A.P.O /
TAP 1/2 A.P.O
33D2040:
ANGELO PO
GRANDI CUCINE
SPA



4127171 "RUBINET
TO CARICO ACQUA;
1/2" / WATER INLET
TAP ø 1/2"
056616:
ELECTROLUX
PROFESSIONAL
S.P.A.
R110120: ILSA SPA
110120: ILSA SPA



4127195 "VALVOL
A A SFERA; 1" /
BALL VALVE, 1"
056885:
ELECTROLUX
PROFESSIONAL
S.P.A.



4127087 RUBINETT
O ACQUA-ASTA
SPEC. FF1/2" /
"INTAKE TAP
FF1/2"
808037:
EMMEPI GRANDI
CUCINE S.R.L.
7060018: GIORIK
SPA



4130044 RUBINETT
O ACQUA G47
17CR905M /
WATER TAP G47
17CR905M
806038:
EMMEPI GRANDI
CUCINE S.R.L.
RTCP800018:
MBM- EUROTEC SRL



- DIV. COOKING
SERVICE

4127138 GRUPPO
VALVOLA SFERA 3/8
COMPLETO /
BALL VALVE
ASSEMBLY 3/8
COMPLETE
A00465: GICO SPA



4130056 RUBINETT
O 1/2" F-F ART.127 /
"TAP 1/2" F-F
ART.127"
700714:
MARENO
INDUSTRIE ALI
SPA
MA700714:
MARENO
INDUSTRIE ALI
SPA



4137068 DRAIN
TAP 3/4" ART.1000
PEL
/
"DRAIN TAP 3/4" ART.1000 PEL"
MA1450500:
MARENO
INDUSTRIE ALI
SPA
MA1450500:
SILKO ALI SPA



4127167 "VALVOL
A SFERA FF- 1" /
BALL VALVE FF-1"
CRO412260:
MARENO
INDUSTRIE ALI
SPA
CRO412260:
SILKO ALI SPA

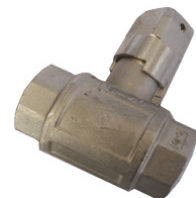

6116034 RUBINETT
O ORIZZONTALE PER
COLONNINA /
TAP
00503004:
MARENO
INDUSTRIE ALI
SPA



4127170 RUBINETT
O CARICO ACQUA
GC66 1320 1/2FF /
LOAD TAP WATER
GC66 1320 1 / 2FF
RTC600075:
MBM- EUROTEC SRL
- DIV. COOKING
SERVICE



THREAD=1/2FF

4127217 KIT
SOSTITUZIONE
RUBINETTO CARICO
ACQUA GC408/GC498

REPLACEMENT KIT
LOAD TAP WATER
408 GC / GC 498

RIC0004837:

MBM- EUROTEC SRL
- DIV. COOKING
SERVICE



4127218 KIT
SOSTITUZIONE
RUBINETTO CARICO
ACQUA

GC477/GC777/GC47 /
REPLACEMENT KIT
LOAD TAP WATER
GC477 / GC777

RIC0004838:

MBM- EUROTEC SRL
- DIV. COOKING
SERVICE



4127219 KIT
SOSTITUZIONE
RUBINETTO CARICO
ACQUA GC49/EC49 /
REPLACEMENT KIT
LOAD TAP WATER
GC49 / EC49

RIC0004844:

MBM- EUROTEC SRL
- DIV. COOKING
SERVICE



4127132 RUBINETT
O CARICO ACQUA
CUOCIPASTA /
LOAD WATER COCK

833471:

OFFCAR THE GREAT
COOKING S.R.L.



4127178 RUBINETT
O CARICO ACQUA /
LOAD WATER COCK

K20131: A.T.A. SRL



4127098 RUBINETT
O D'ENTRATA
CUOCIPASTA
BERTO'S /

"SHUT-OFF VALVE
CONNECTION 1/2"
BERTO'S"

31686800:

BERTO'S SPA



6116038 RUBINETT
O DI ARRESTO
DRITTO ECO CON
BORCHIA E
MANIGLIA /
STOP COCK WITH
HANDLE



4127120 "RUBINET
TO ACQUA DX; 1/2"
FF" /

"WATER COCK
RIGHT 1/2" FF"

003516:

ELECTROLUX
PROFESSIONAL
S.P.A.



4117456 RUBINETT

O ACQUA
COD.02316123
ENT.SX /
WATER COCK COD.
02316123 ENT. SX

MACM127800:

MARENO
INDUSTRIE ALI
SPA

003517:

ELECTROLUX
PROFESSIONAL
S.P.A.

MACM127800:

SILKO ALI SPA



3108285= KNOB
COLD WATER,

3108605= KNOB
HOT WATER

4127175 RUBINETT
O CARICO ACQUA ø
1/2 FF /
SHUT-OFF VALVE ø
1/2 FF

790304640: GICO
SPA



4127136 KIT
SOSTITUZIONE
RUBINETTO CARICO
MODULAR /

TAP MODULAR

91013000:

MODULAR SPA



4127133 RUBINETT
O DI CARICO ACQUA
CUOCIPASTA SERIE
90 1/2"MM /

TAP WATER LOAD
RANGE PASTA
COOKER 90 1/2 "MM

67801014:

MODULAR SPA



S&P Cooking Catalogue 2017

4127068 VALVOLA
DEPRESSIONE /
DEPRESSION VALVE

3360650:

ANGELO PO
GRANDI CUCINE
SPA



4127155 RUBINETT
O DI SCARICO DA 1" /
DRAIN TAP 1"



4127069 KIT
VALVOLA DI
SICUREZZA 3/4
COMPL. /
3/4 SAFETY VALVE
KIT

6300515:

ANGELO PO
GRANDI CUCINE
SPA



4127027 RUBINETT
O DI SCARICO DA
1"1/4F /
"DRAIN TAP 1"1/4F"

0100541:

SILKO ALI SPA
1677200:
MARENO
INDUSTRIE ALI
SPA



4127228 "VALVOL
A DI SICUREZZA A
MOLLA: 0,45BAR" /
SPRING SAFETY
VALVE 0,45BAR

056691: ELECTROLUX
X PROFESSIONAL
S.P.A.



4127172 RUBINETT
O DI SCARICO
TECNO ATTACCO
FISSO DA 1"1/2
FEMMINA /
DRAIN TAP 1"1/2 F



4127192 RUBINETT
O SFERA SCARICO
1/2"FF /
BALL VALVE DRAIN
1/2 "FF



4127074 RUBINETT
O DI SCARICO DA 2"
DADO GIREVOLE
C/SICUREZZA /
"DRAIN TAP 2" ""

050285:

ELECTROLUX
0C4850:
ELECTROLUX
008027:
ELECTROLUX



= 2101788

4127193 RUBINETT
O SFERA SCARICO
3/4" FF /
BALL VALVE DRAIN
3/4 "FF



4127066 RUBINETT
O SCARICO 2" A.PO /
"DRAIN COCK 2" ""
A.PO"

33D2290: ANGELO
PO

CR0682780:
MARENO
CR0682780: SILKO



4127176 RUBINETT
O SCARICO
CUOCIPASTA 1" F-F /
BALL VALVE 1" F-F

K20126: A.T.A. SRL
SIRO100590:

SILKO ALI SPA

0100590:

SILKO ALI SPA



4127222 "RUBINETT
TONE DI SCARICO; 2'
M" /
"DRAIN TAP ; 2 'M"

053159:

ELECTROLUX
PROFESSIONAL
S.P.A.



4127230 RUBINETT
O DI SCARICO FF 1" /
DRAIN TAP FF 1"



4127190 VALVOLA
A SFERA
MOTORIZZATA /
MOTORIZED BALL
VALVE

R65110560:

LAINOX ALI SPA



4127227 VALVOLA
1" 230V 50/60 Hz /
SOLENOID VALVE 1"
230V 50/60 Hz
R65110570:
LAINOX ALI SPA



4127205 VALVOLA
A SFERA M-F 3/4G /
BALL VALVE M-3 F /
4G
20603:
**BREMA ICE
MAKERS SPA**



4127194 GRUPPO
ENTRATA ACQUA /
GROUP WATER
INLET
OC8683:
**ELECTROLUX
PROFESSIONAL
S.P.A.**



4127070 GRUPPO
RUBINETTO A.PO
6004730 /
TAP A.PO 6004730
6004730:
**ANGELO PO
GRANDI CUCINE
SPA**

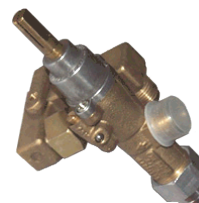

4127106 VALVOLA
DI NON RITORNO
DVGW /
NON RETURN
VALVE DVGW
048191:
**ELECTROLUX
PROFESSIONAL
S.P.A.**
OL3240:
**ELECTROLUX
PROFESSIONAL
S.P.A.**



3105009 PIEDINO
LAVATAZZE M8 /
CUP-WASHERS
SUPPORT M8
904980:
SILANOS SRL

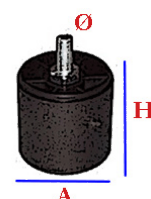

H=13mm, A=39mm,
Ø=8mm

4127073 RIDUTTO
RE DI PRESSIONE
C/MANOMETRO
1/6bar /
PRESSURE-REDUCER
WITH MANOMETER
1/6bar



3105054 PIEDINO
LAVASTOVIGLIE
M10 hmrsn /
FOOT DISHWASHER
M10 hmrsn
984006000:
**GRUPPO CIMBALI
SPA**
9030005:
**GRUPPO CIMBALI
SPA**

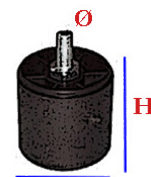

H=15mm, A=33mm,
Ø=10mm

4127094 CENTRALI
NA 2 POSTI X
ACCOPP. /
GAS VALVE



3105001 PIEDINO
LT M10 /
SUPPORT LT M10
69000230:
RANCILO SPA

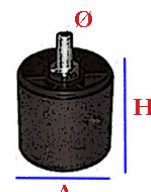

H=13mm, A=39mm,
Ø=10mm

4127095 CENTRALI
NA 3 POSTIX ACCOP.
/ GAS VALVE

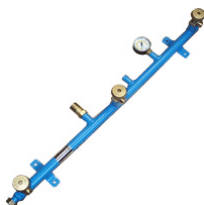

3105030 PIEDINO
30MM M10 /
FOOT 30 MM
210203:
COMENDA ALI SPA



H=30mm, A=60mm,
Ø=10mm

4127096 KIT
REGOL.6KGXCEN
ALINA /
ADJUSTABLE KIT
6KG FOR GAS
VALVE



S&P Cooking Catalogue 2017

3105022 PIEDINO
BASE ESAGONALE
HNVD M10 /
SUPPORT HOONVED
210210:
HOONVED - ALI
SPA
25209ex:
HOONVED - ALI
SPA

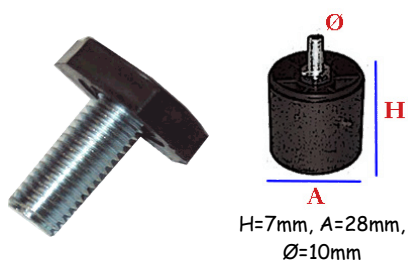

H
A
H=7mm, A=28mm,
Ø=10mm

3105045 PIEDINO
M6 D.20 H.15mm /
LEG DD 2015 H
P000PIA02QQQEX:
MAZZER LUIGI
SPA
P000PIA04QQQ:
MAZZER LUIGI
SPA

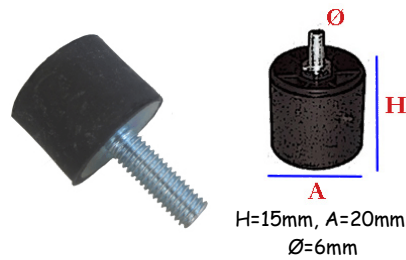

H
A
H=15mm, A=20mm,
Ø=6mm

3105037 PIEDINO
REGOLABILE D=47 /
ADJUSTABLE
SUPPORT D=54
0000970:
ELFRAMO SPA

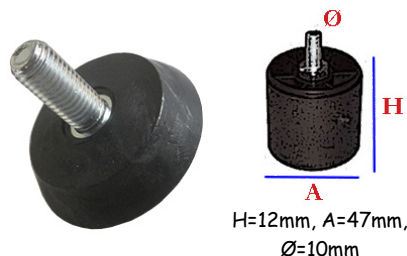

H
A
H=12mm, A=47mm,
Ø=10mm

3105008 PIEDINO
Z11 COMPLETO M10
/
COMPLETE
SUPPORT Z11
10090012:
RANCILIO SPA

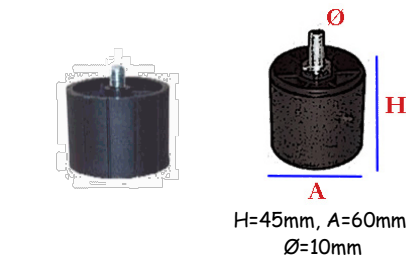

H
A
H=45mm, A=60mm,
Ø=10mm

3105015 PIEDINO
M10 LAVAPIATTI /
FOOT M10
904990:
SILANOS SRL

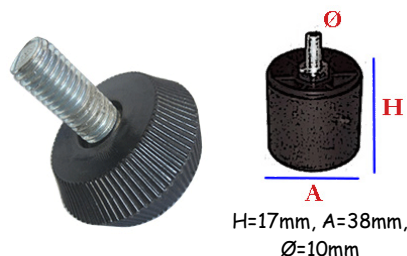

H
A
H=17mm, A=38mm,
Ø=10mm

3105017 PIEDINO
REGOLABILE/RIALZ
ABILE UNIVERSALE
/
UNIVERSAL
ADJUSTABLE/RAISA
BLE SUPPORT
0300030+0300040:
MAGISTER
SISTEMA CAFFE'
SRL
900069:
MAGISTER
SISTEMA CAFFE'
SRL

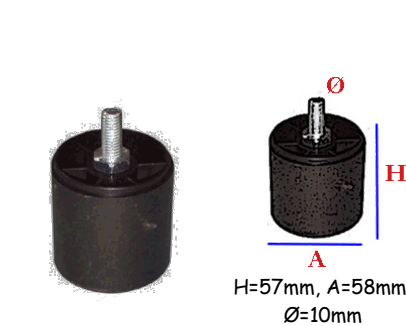

H
A
H=57mm, A=58mm,
Ø=10mm

3105024 PIEDINO
REGOLABILE FABA /
SUPPORT FABA
ALL MODEL/TUTTI
I MODELLI: FABA
SRL



3105032 PIEDINO
AFFETTATRICE
FAMIGLIA A
VENTOSA M5 /
SUPPORT FOR
SLICER M5



3105066 PIEDINI
IN GOMMA /
RUBBER SUPPORT
EB019: OBEL SRL

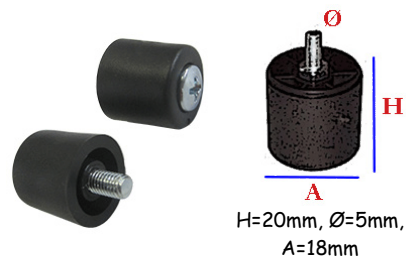

H
A
H=20mm, Ø=5mm,
A=18mm

3105050 PIEDINO
VENTOSA ALTO M6
H.45mm /
FOOT P.6 H. 42 mm

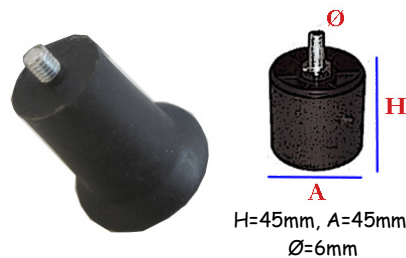

H
A
H=45mm, A=45mm,
Ø=6mm

3105026 PIEDINO
COMPLETO MAZZER
/
COMPLETE
SUPPORT MAZZER
S00SPIA01QQQ:
MAZZER LUIGI
SPA

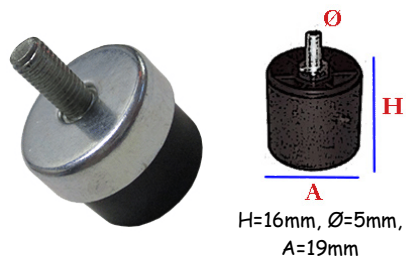

H
A
H=16mm, Ø=5mm,
A=19mm

3105042 PIEDINO
PER AFFETTATRICE
M8 H35mm /
SLICER SUPPORT H
33mm D.8mm

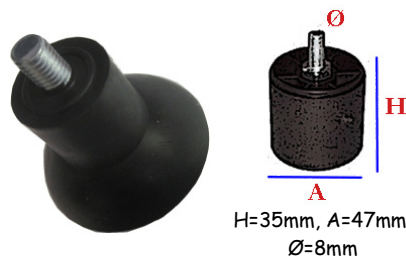

H
A
H=35mm, A=47mm,
Ø=8mm

S&P Cooking Catalogue 2017

3105035 PIEDINO
A VENTO D.40 H.10 /
FOOT D.40 H.10



3105044 PIEDINO
INOX 160/268 M12 /
STAINLESS STEEL
DEVICE LEG 160/268
M12



3105023 PIEDINO
BASE ESAGONALE
INOX 55/65
REGOLABILE M10 /
STAINLESS STEEL
SUPPORT 55/65 M10

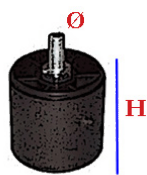

A
H min=55mm,
H max=65mm,
A=33mm, Ø=10mm

3105033 "PIEDE IN
ACCIAIO
INOSSIDABILE 2""
C/F H=1" /
"STAINLESS STEEL
FOOT C/F H=1""



926117:
ELETTROBAR
DIVISIONE DELLA
EUROTEC SRL

3105061 PIEDE
INOX H100/150 VITE
M10X40 /
LEG INOX H100 / 150
SCREW M10x40
MO21100020:
COLD LINE S.R.L.



3105048 PIEDINO
REGOLABILE
RESINA /
ADJUSTABLE FOOT
RESIN



H=17mm, HTot=39mm,
A=27mm, Ø=17mm

K01086:
ARISTARCO
KASTEL SPA
10017:
BREMA ICE
MAKERS SPA

3105056 PIEDINO
INOX Ø60
REGOLABILE H=12-
19cm /
ADJUSTABLE FOOT
STAINLESS Ø60 H =
12-19cm
1000090:
KRUPPS S.R.L.



3105060 PIEDINO
REGOLABILE IN
PLASTICA NERO
ALTO /
ADJUSTABLE FOOT
PLASTIC BLACK
HIGH



H=20mm, HTot=50mm,
A=27mm, Ø=17mm

DW10851:
DIHR-ALI SPA

3105043 PIEDINO
INOX 132/178
REGOLABILE M10 /
DEVICE LEG M10
20613:
BREMA ICE
MAKERS SPA
923066:
BRICE ITALIA SRL



Hmin=132mm,
Hmax=178mm,
A=40mm, Ø=10mm

3105038 PIEDINO
ESAGONALE PER
LAVABICCHIERI /
GLASS-WASHERS
SUPPORT
461010:
ELETTROBAR
DIVISIONE DELLA
EUROTEC SRL



3105006 PIEDINO
INOX 130/195
REGOLABILE M12 /
STAINLESS STEEL
SUPPORT LS 1105
15890135:
RANCILIO SPA
331223:
HOONVED - ALI
SPA
331223:
COMENDA ALI SPA



H min=130mm, H
max=195mm, A=51mm,
Ø=12mm

3105028 PIEDINO
GOMMA NERA NE
AC /
BLACK RUBBER
FOOT S90 NE SE
210404:
COMENDA ALI SPA
H210404:
HOONVED - ALI
SPA

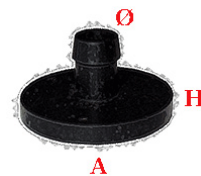

H=5mm, A=34mm,
Ø=10mm

3105020 GOMMIN
O PER PIEDINO
MAGISTER /
RUBBER FOOT FOR
Magister
030040:
MAGISTER
SISTEMA CAFFE'
SRL



1125028 RACCORD
O BICONO D.6 M10X1
SIT /
PILOT BURNER
LOCKING SCREW
6mm M10X1 SIT
RTC900217:
MBM- EUROTEC SRL
- DIV. COOKING
SERVICE
MA1394800:
MARENO
INDUSTRIE ALI
SPA
0100884:
SILKO ALI SPA



3105053 PIEDINO
DURO /
FOOT HARD
C00071614:
MACAP SRL



3105055 PIEDINO /
FOOT
PR60009: FABA SRL

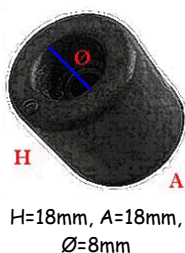

1125223 RACCORD
O X BICONO D.4 in
acciaio /
INOX JUNCTION FOR
PIPE OLIVE D.4



1125021 RACCORD
O A GOMITO MINISIT
DA 3/8 /
ELBOW JUNCTION
MINISIT 3/8
0906252: SIT



gasket=2101053

1125026 RACCORD
O FISSAGGIO TC /
TC FIXING
JUNCTION
OC0121:
ELECTROLUX
PROFESSIONAL
S.P.A.



1125024 RACCORD
O MINISIT 1/2 /
MINISIT JUNCTION
1/2
0906246: SIT



gasket=2101053

1125013 RACCORD
O + BICONO 0958030
D. 4 /
PILOT BURNER
LOCKING SCREW
4mm 0958030



13888000-1394700:
MARENO
INDUSTRIE ALI
SPA
TRCU700141:
MBM- EUROTEC
SRL - DIV.
COOKING SERVICE

1125149 GHIERA DI
RIDUZIONE
1/4"x3/8" SENZA
BATTUTA /
RING NUT 1/4"x3/8"



1125176 RACCORD
O PORTAGOMMA /
FITTING HOLDER
RUBBER



1125181 RACCORD
O BICONO X TUBO
D.4 /
PIPE FITTING
BICONE D.4
K22139: A.T.A. SRL



1125115 RACC.
PORTAGOMMA M D.8
3/8x ADDOLCITORE
AUTOMATICO /
RUBBER-HOLDER M
D.8 3/8



1125116 RACC.
PORTAGOMMA M
D.13 3/8 /
RUBBER-HOLDER M
D.13 3/8



1125038 RACC.
SERPENTINA
VAPORE /
STEAM COIL
CONNECTION



280512:
COMENDA ALI SPA

1125071 PORTAGO
MMA F1/8 X 6 /
RUBBER-HOLDER
F1/8 X 6

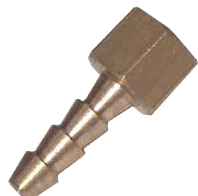

1125034 PORTAGO
MMA OTTONE
M.14X1 /
BRASS HOSE
NOZZLE M.14X1



34767:
HOONVED - ALI
SPA

1125175 RACCORD
O VALVOLA /
FITTING VALVE



1125182 "RACCORD
DO PORTAGOMMA F
1/2" X 14" /
FITTING HOLDER
RUBBER-F 1/2 " X 14 "



1125179 RACCORD
O IN OTTONE 3/8
PORTAGOMMA D12 /
BRASS CONNECTOR
3/8 HOSE
CONNECTION D12



1125088 RACCORD
O 1200322/1 /
JUNCTION 1200322/1



927015:
ELETTRORBAR
DIVISIONE DELLA
EUROTEC SRL

1125157 RACCORD
O CORPO POMPA FIR
M16 /
BODY PUMP
CONNECTION FIR
M16



1125166 RACCORD
O 3/8" /
FITTING 3/8 "



1549:
UNIVER-BAR SRL

1125157 RACCORD
O CORPO POMPA FIR
M16 /
BODY PUMP
CONNECTION FIR
M16

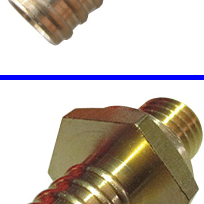

1125087 RACCORD
O PER ACQUA
CALDA RANC. /
JUNCTION FOR HOT
WATER RANC.



1125167 RACCORD
O POMPA M12 /
BODY PUMP
CONNECTION M12

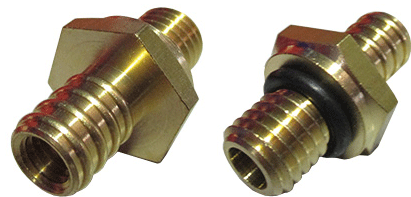

4758:
UNIVER-BAR SRL

1125219 RACCORD
O POMPA M12 /
FITTING PUMP M12

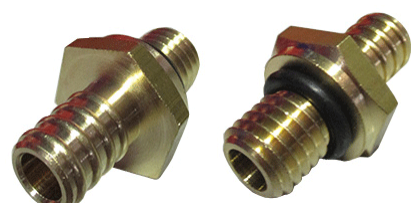

M12

1125138 NIPPLES
1/2" M CROMATO - F
PASSO METRICO /
"NIPLES 1/2" M"



GASKET= 2107162

1125217 RACCORD
O /
JUNCTION
0C0710:

ELECTROLUX
PROFESSIONAL
S.P.A.



1125218 "GOMITO
3/8" F/F INOX" /
INOX ELBOW
JUNCTION 3/8 F/F
35272:
HOONVED - ALI
SPA



1125159 RACCORD
O TENUTA OLIO /
OIL SEAL FITTING



Ø GUARNIZIONE=
22X14X1,5mm

1125171 "GOMITO
MF 3/4" /
ELBOW MF 3/4"



1125174 RACCORD
O GAS 1/4M /
GAS FITTING 1/4M



1125032 RACCORD
O TIPO BAR /
JOINT TYPE BAR
210074:
MAGISTER
SISTEMA CAFFE'
SRL



1125033 RACCORD
O ALIMENTAZIONE
RISCIACQUO /
FITTING SUPPLY
RINSE
34155:
HOONVED - ALI
SPA



1125153 RACCORD
O RAPIDO 10-3/8"
X6101077 /
CONNECTION 10-3/8"
X 6101077



1125154 RACCORD
O RAPIDO 8-3/8" /
CONNECTION 8-3/8"





Corso Sempione 238/8 - 21052 Busto Arsizio –VA- Italy
phone 0039 0331 324053 - fax 0039 0331 671063

C.F - P.IVA IT 02980880120

Società Unipersonale - Cap. Soc. € 10.000,00 iv. – Iscr. Reg. Imprese di VA 02980880120

info@sep-spareparts.com -- www.sep-spareparts.com