

S&P



Washing

Washing Catalogue 2017



S&P

**Corso Sempione 238/8
21052 Busto Arsizio (VA)
ITALY**

phone: +39.0331.324053



fax: +39.0331.671063



Come ordinare, how to order, comment commander, Wie konnes Sie bestellen, Como ordinar :

Phone: +39.0331.324053

Fax : +39.0331.671063

E-mail: info.sep-spareparts.com

Ricambi fuori catalogo

preghiamo, nel limite del possibile, di fornire i seguenti dati:

- Nome del costruttore
- Modello dell'apparecchiatura
- Numero matricola ed anno costruzione

Spare parts out of catalogue

Please give us the following data:

- Manufacturer's name
- Machine's model
- Serial number and manufacture year

Pièces hors catalogue

Veuillez nous fournir les données suivantes :

- Nome du constructeur
- Model de la machine
- Numéro de série et année de fabrication

Ersatzteile, die im Katalog nicht enthalten sind

Im Rahmen des Möglichen, bitten wir Sie, um folgenden daten uns mitzuteilen und zwar:

- Name des Herstellers
- Maschinenmodell
- Fabriknummer und Herstellungsjahr

Repuestos fuera del catalogo

Les pedimos que en el limite de lo posible proporcionar los siguientes datos:

- Nombre del constructor
- Modelo del aparato
- Numero de matricula y año de construcción

In questo catalogo sono raffigurati i materiali più rappresentativi e di maggior importanza; a richiesta sono disponibili gli articoli specifici per i marchi più diffusi.

This catalogue shows the most representative and important materials; at request, the specific items of the well-known stamps are available.

Ce catalogue montre les matériels plus représentatifs et de majeure importance; à requête, les articles spécifiques des maisons plus connues sont disponibles.

In diesem Katalog sind die wichtigsten Artikel dargestellt; auf Wunsch sind bestimmte Artikel der meistverbreitetsten Firmen verfügbar.

En este catalogo se presentan los materiales más representativos y de mayor importancia; sobre pedido están disponibles los artículos específicos de las marcas más conocidas.

Le informazioni contenute in questo catalogo sono soggette a modifiche senza preavviso.

Nessuna parte di questo catalogo può essere riprodotta in qualsiasi forma o mezzo elettronico o meccanico, per alcun uso, senza il permesso scritto della S&P.

The information you find in this catalogue can be modified without advise.

This catalogue cannot be reproduced in any form and electronic or mechanical means without the express written authorisation of S&P.

Les renseignements de ce catalogue peuvent être modifiés sans avis.

Ce catalogue ne peut pas être reproduit avec n'importe quelle forme ou moyen électronique ou mécanique sans autorisation écrite exprimée de la S&P.

Die in diesem Katalog enthaltenen Angaben können ohne Vorbehalten geändert werden.

Ohne schriftliche Genehmigung von der Firma S&P, kann keine Seite von diesem Handbuch entweder elektronisch oder mechanisch für kein Ziel vervielfältigt werden.

Las informaciones contenidas en este catalogo estan sujetas a modificaciones sin pre aviso.

Ninguna parte de este catalogo puede ser reproducida en cualquier forma o medio electrónico o mecánico para algún uso sin el permiso escrito de la S&P.

Condizioni generali

Prezzi: Le quotazioni espresse nei listini si intendono indicative e possono essere soggette a variazioni senza preavviso.

I prezzi non comprendono spese di trasporto, imballaggio, IVA ed eventuali altri oneri accessori; le spese per emissione di ricevute bancarie e tratte sono a carico del Cliente.

Resa della merce: Il materiale si intende venduto franco ns. magazzino, e pertanto l'obbligo di fornitura si intende assolto con la presa in consegna della merce da parte del trasportatore. La merce viaggia sempre, anche in caso di porto franco destino, a rischio e pericolo del Committente e, salvo precise disposizioni da parte del medesimo, l'inoltro della merce a destino verrà effettuato nel modo da noi ritenuto più idoneo, senza che ciò comporti alcuna responsabilità da parte della S&P, che non potrà essere ritenuta responsabile di eventuali ritardi o disagi causati dal vettore.

Reclami: La S&P agisce quale rivenditore di materiali prodotti da terzi, non può pertanto assumersi responsabilità riferita ad eventuali difetti degli stessi. Qualsiasi reclamo dovrà essere indirizzato ad S&P con lettera o fax entro e non oltre otto (8) giorni dal ricevimento della merce.

Responsabilità: La S&P non si assume nessuna responsabilità per quanto riguarda i dati tecnici e le caratteristiche riportate nei propri cataloghi, né per le variazioni che le singole case costruttrici dovessero apportare.

Sale terms

Prices: The prices are indicative and can be changed without advice.

The costs of transport, packaging and eventual charges are not included in the prices.

Delivery terms: Ex-works

Complaints: S&P is a reseller so is not responsible for material defects. Every complaint has to be sent to S&P by fax or letter within 8 days on receipt of the goods.

Responsability: The S&P is not responsible for technic data or manufacture changes indicate in the catalogue.

Conditions générales de vente

Prix: Les prix sont indicatifs et peuvent être sujets à modifications sans avis. Ils ne comprennent costs de transport, emballage et charges eventuelles.

Délais de livraison: Ex-works.

Réclamations: La S&P est revendeur de matériel de tiers donc ne peut pas être responsable de eventuels défauts de fabrication. Les réclamations doivent être envoyées par fax ou lettre dans 8 jours de reception de la marchandise.

Responsabilité : La S&P n'est pas responsable pour les données techniques indiquées dans le catalogue ainsi que les variations faites des constructeurs.

Allgemeine Bedingungen

Preise: Die in unserer Liste angegebenen Preise können ohne Vorankündigung geändert werden. Transportkosten, Verpackung und eventuelle zusätzlichen Kosten sind in den Preisen nicht inbegriffen.

Lieferung: Ex-works.

Reklamationen: Eventuelle Reklamationen müssen schriftlich direkt an die Firma S&P innerhalb von 8 Tagen nach Warenerhalt vorgebracht werden.

Verantwortlichkeit: Die Richtigkeit der im katalog von verschiedenen Herstellern angegebenen technischen Angaben und Maße sind ohne Gewähr.

Condiciones generales

Precios: La cotizaciones espuestas en la lista se entienden indicativas y pueden ser sujetas a variaciones sin preaviso.

Los precios no comprenden gastos de transporte, embalaje y eventuales gastos accesorios.

Devolucion de la mercaderia: Ex-works.

Reclamos: La S&P actua como revendedor de materiales producidos por terceros, portanto no puede asumirse responsabilidad referida a eventuales defectos de los mismos productos. Cualquier reclamo tendrá que ser indirisado a la S&P con carta o fax entre y no depues de 8 dias del recevimiento de la mercanti

Responsabilidad: La S&P no se asume ninguna responsabilidad por quanto riguarda los datos tecnicos y las características reportadas en los propios catalogos ni por las variaciones que la singulas casas constructoras trendrian che aportar.

Washing 2017 INDEX

Description	Cod.	Example					Page
Articoli Complementari / Compl.Items	----						420
Addolcitori/ Water softners	6101						392
Boiler / Boilers	3106						367
Cavi/ Cables	1128						150
Centraline elettroniche/ P.C. Boards	1114						208
Cerniere per porta / Door hinges	8111						372
Cestelli in plastica/ Plastic baskets	5101						379
Cestelli in rete/ Supports	5102						388
Commutatori/ Commutators	1115						143
Complementi tecnici/ Technical complements	1143						127
Condensatori / Capacitors	1135						92
Cricchetti/ Pawls	3125						328
Dadi-viteria/ Nuts and screws	1141						361
Doccioni/ Showers/ cocks	6116						397

Washing 2017 INDEX

Description	Cod.	Example					Page
Dosatori elettrici / Electric dosing pumps	1123						119
Dosatori idraulici / Rinsing dosing pumps	6104						124
Elettropompe / Pumps	1103						47
Elettrovalvole/ Solenoid valves	1124						227
Filtri / Filters	3126						108
Getti lavaggio/ Wash rods	3102						286
Getti risciacquo / Rinse rods	3101						278
Giranti / Fans/Rods	3109						79
Giranti/bracci lavaggio e risciacquo/ Fans/wash and rinse rods	3112						242
Girelli/ Supports	3114						396
Guarnizioni O-Ring/ O-Ring gaskets	2101						170
Guarnizioni elettropompe / Pump gaskets	2104						93
Guarnizioni piatte/ Flat gaskets	2102						400
Guarnizioni teflon / Teflon gaskets	2107						293
Interruttori/ Switches	1105						133

Washing 2017 INDEX

Description	Cod.	Example					Page
Lampade spia/ Lamps	1104						129
Manicotti / Sleeve	2108						94
Manopole/ Knobs/Handles	3108						237
Membrane / Membrane	2105						125
Microinterruttori/ Micro-switches	1107						182
Molle / Springs	1117						408
Motoriduttori / Motoreducers	1134						237
Perni/Pins	1140						357
Piedini / Feet	3105						415
Pressostati/ Pressure switches	1113						225
Pulsanti/ Push buttons	1108						136
Raccorderia / Junctions/nipples	1125						418
Raccordi / Junctions	3118						365
Raccordi di scarico / Drain junctions	3124						318
Relè-contattori/ Contactors	1109						191

Washing 2017 INDEX

Description	Cod.	Example					Page
Resistenze/ Heating elements	1101						20
Rubinetti / Cocks	4127						292
Sonde/ Probes	1129						222
Tappi troppo-pieno / Overflows	3111						307
Tenute meccaniche / Mechanic seals	3110						89
Termostati/ Thermostats	1106						152
Timer- temporizzatori/ Timers	1112						199
Trappole aria / Air traps	3113						303
Tubi di carico/ Load pipes	2110						374
Tubi scarico/ Drain pipes	2109						376
Vari lavatazze/ Parts for cup-washer	4115 4120						330
Vari macchina per caffè/ Parts for coffee machines	4116						367

CONTROLLO DELLE DIMENSIONI O-RINGS

MEASUREMENT OF THE O-RINGS SIZES

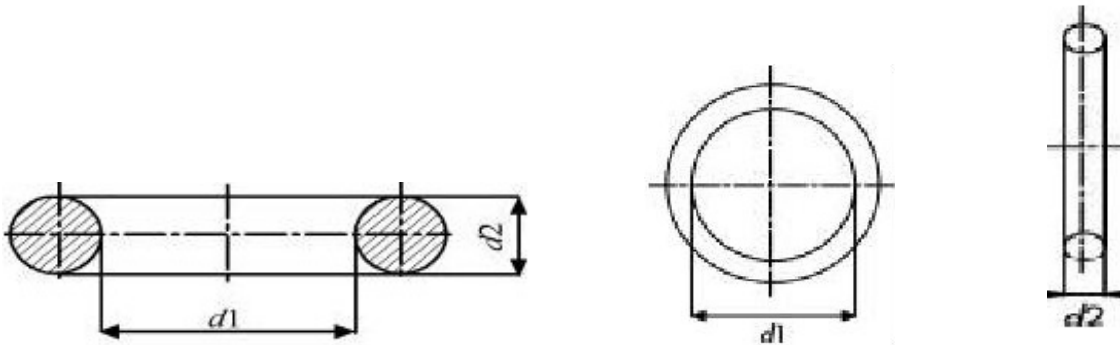

d1: diametro interno
d1: internal diameter
d1: diamètre intérieur
d1: diámetro interior

d2: spessore OR (diametro della corda)
d2: OR thickness (torus)
d2: épaisseur OR
d2: OR espesor

-Il controllo di D1 e D2 viene fatto in base alle tolleranze della tabella ISO 3601 (ex DIN 3771) parte 1.

-The measurement of D1 and D2 is carried out on the basis of the tolerances of the table ISO 3601 (ex DIN 3771) part 1.

Esempio di misurazione delle OR: codice **2101303**: (d1) 3,69 x (d2) 1,78

How to measure O-Rings: example code **2101303**: (d1) 3,69 x (d2) 1,78

d1: 3,69 diametro interno OR/ OR internal diameter

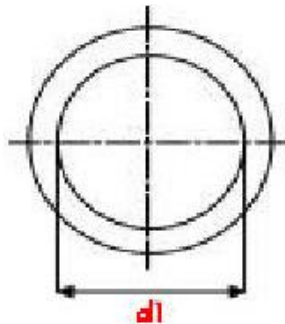

d2: 1,78 diametro della corda OR/OR thickness (torus)

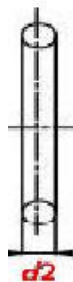

S&P O-RINGS NBR

Codice/Code	Descrizione/Description d1xd2	Codice/Code	Descrizione/Description d1xd2
2101300	1,78X1,78 O-RING	2101346	88,64X1,78 O-RING
2101301	2,57X1,78 O-RING	2101347	91,70X1,78 O-RING
2101302	2,90X1,78 O-RING	2101348	95,00X1,78 O-RING
2101303	3,69X1,78 O-RING	2101349	98,05X1,78 O-RING
2101304	4,47X1,78 O-RING	2101350	101,34X1,78 O-RING
2101305	5,28X1,78 O-RING	2101351	104,40X1,78 O-RING
2101306	6,07X1,78 O-RING	2101352	107,70X1,78 O-RING
2101307	6,35X1,78 O-RING	2101353	114,00X1,78 O-RING
2101308	6,75X1,78 O-RING	2101354	117,10X1,78 O-RING
2101309	7,66X1,78 O-RING	2101355	120,40X1,78 O-RING
2101310	8,73X1,78 O-RING	2101356	133,10X1,78 O-RING
2101311	9,25X1,78 O-RING	2101357	142,11X1,78 O-RING
2101312	10,82X1,78 O-RING	2101358	161,16X1,78 O-RING
2101313	11,11X1,78 O-RING	2101359	164,34X1,78 O-RING
2101314	12,42X1,78 O-RING	2101360	2,20X1,90 O-RING
2101315	14,00X1,78 O-RING	2101361	2,40X1,90 O-RING
2101316	15,60X1,78 O-RING	2101362	2,60X1,90 O-RING
2101317	17,16X1,78 O-RING	2101363	3,40X1,90 O-RING
2101318	18,77X1,78 O-RING	2101364	4,20X1,90 O-RING
2101319	20,35X1,78 O-RING	2101365	4,90X1,90 O-RING
2101320	21,95X1,78 O-RING	2101366	5,70X1,90 O-RING
2101321	23,52X1,78 O-RING	2101367	6,40X1,90 O-RING
2101322	25,12X1,78 O-RING	2101368	7,20X1,90 O-RING
2101323	26,70X1,78 O-RING	2101369	8,00X1,90 O-RING
2101324	28,30X1,78 O-RING	2101370	8,90X1,90 O-RING
2101325	29,87X1,78 O-RING	2101371	2,84X2,62 O-RING
2101326	31,47X1,78 O-RING	2101372	3,63X2,62 O-RING
2101327	33,05X1,78 O-RING	2101373	4,42X2,62 O-RING
2101328	34,65X1,78 O-RING	2101374	5,23X2,62 O-RING
2101329	36,27X1,78 O-RING	2101375	6,02X2,62 O-RING
2101330	37,82X1,78 O-RING	2101376	7,60X2,62 O-RING
2101331	39,45X1,78 O-RING	2101377	9,13X2,62 O-RING
2101332	41,00X1,78 O-RING	2101378	9,19X2,62 O-RING
2101333	44,17X1,78 O-RING	2101379	9,92X2,62 O-RING
2101334	47,37X1,78 O-RING	2101380	10,78X2,62 O-RING
2101335	50,52X1,78 O-RING	2101381	11,91X2,62 O-RING
2101336	53,67X1,78 O-RING	2101382	12,37X2,62 O-RING
2101337	56,87X1,78 O-RING	2101383	13,10X2,62 O-RING
2101338	60,04X1,78 O-RING	2101384	13,95X2,62 O-RING
2101339	63,22X1,78 O-RING	2101385	15,08X2,62 O-RING
2101340	66,40X1,78 O-RING	2101386	15,54X2,62 O-RING
2101341	69,57X1,78 O-RING	2101387	15,88X2,62 O-RING
2101342	72,76X1,78 O-RING	2101388	17,13X2,62 O-RING
2101343	75,94X1,78 O-RING	2101389	17,86X2,62 O-RING
2101344	79,00X1,78 O-RING	2101390	18,72X2,62 O-RING
2101345	82,28X1,78 O-RING	2101391	20,29X2,62 O-RING



S&P O-RINGS NBR

Codice/Code	Descrizione/Description d1xd2	Codice/Code	Descrizione/Description d1xd2
2101392	20,64X2,62 O-RING	2101438	139,38X2,62 O-RING
2101393	21,90X2,62 O-RING	2101439	145,73X2,62 O-RING
2101394	22,23X2,62 O-RING	2101440	152,07X2,62 O-RING
2101395	23,47X2,62 O-RING	2101441	158,43X2,62 O-RING
2101396	23,81X2,62 O-RING	2101442	164,78X2,62 O-RING
2101397	25,07X2,62 O-RING	2101443	171,13X2,62 O-RING
2101398	26,65X2,62 O-RING	2101444	177,48X2,62 O-RING
2101399	28,25X2,62 O-RING	2101445	183,83X2,62 O-RING
2101400	29,83X2,62 O-RING	2101446	196,53X2,62 O-RING
2101401	31,42X2,62 O-RING	2101447	202,88X2,62 O-RING
2101402	33,00X2,62 O-RING	2101448	209,23X2,62 O-RING
2101403	34,60X2,62 O-RING	2101449	221,93X2,62 O-RING
2101404	36,17X2,62 O-RING	2101450	228,28X2,62 O-RING
2101405	37,77X2,62 O-RING	2101451	234,63X2,62 O-RING
2101406	39,35X2,62 O-RING	2101452	240,98X2,62 O-RING
2101407	40,95X2,62 O-RING	2101453	8,90X2,70 O-RING
2101408	42,52X2,62 O-RING	2101454	10,50X2,70 O-RING
2101409	44,12X2,62 O-RING	2101455	12,10X2,70 O-RING
2101410	45,70X2,62 O-RING	2101456	13,60X2,70 O-RING
2101411	47,30X2,62 O-RING	2101457	15,10X2,70 O-RING
2101412	48,90X2,62 O-RING	2101458	16,90X2,70 O-RING
2101413	50,47X2,62 O-RING	2101459	18,40X2,70 O-RING
2101414	52,07X2,62 O-RING	2101460	4,34X3,53 O-RING
2101415	53,65X2,62 O-RING	2101461	7,52X3,53 O-RING
2101416	55,25X2,62 O-RING	2101462	9,12X3,53 O-RING
2101417	56,82X2,62 O-RING	2101463	15,47X3,53 O-RING
2101418	58,42X2,62 O-RING	2101464	18,64X3,53 O-RING
2101419	60,00X2,62 O-RING	2101465	20,22X3,53 O-RING
2101420	61,60X2,62 O-RING	2101466	21,82X3,53 O-RING
2101421	63,17X2,62 O-RING	2101467	23,40X3,53 O-RING
2101422	64,77X2,62 O-RING	2101468	25,00X3,53 O-RING
2101423	66,35X2,62 O-RING	2101469	25,80X3,53 O-RING
2101424	67,95X2,62 O-RING	2101470	26,57X3,53 O-RING
2101425	69,52X2,62 O-RING	2101471	28,17X3,53 O-RING
2101426	71,12X2,62 O-RING	2101472	29,75X3,53 O-RING
2101427	72,70X2,62 O-RING	2101473	31,34X3,53 O-RING
2101428	75,88X2,62 O-RING	2101474	32,93X3,53 O-RING
2101429	80,60X2,62 O-RING	2101475	34,52X3,53 O-RING
2101430	82,22X2,62 O-RING	2101476	36,10X3,53 O-RING
2101431	88,58X2,62 O-RING	2101477	37,70X3,53 O-RING
2101432	94,93X2,62 O-RING	2101478	39,70X3,53 O-RING
2101433	101,28X2,62 O-RING	2101479	40,87X3,53 O-RING
2101434	113,98X2,62 O-RING	2101480	41,28X3,53 O-RING
2101435	120,33X2,62 O-RING	2101481	42,86X3,53 O-RING
2101436	126,67X2,62 O-RING	2101482	44,05X3,53 O-RING
2101437	133,00X2,62 O-RING	2101483	44,45X3,53 O-RING

S&P O-RINGS NBR

Codice/Code	Descrizione/Description d1xd2	Codice/Code	Descrizione/Description d1xd2
2101484	46,04X3,53 O-RING	2101530	139,30X3,53 O-RING
2101485	47,23X3,53 O-RING	2101531	142,47X3,53 O-RING
2101486	47,62X3,53 O-RING	2101532	145,65X3,53 O-RING
2101487	49,20X3,53 O-RING	2101533	148,82X3,53 O-RING
2101488	50,40X3,53 O-RING	2101534	152,00X3,53 O-RING
2101489	50,80X3,53 O-RING	2101535	158,35X3,53 O-RING
2101490	52,40X3,53 O-RING	2101536	164,70X3,53 O-RING
2101491	53,57X3,53 O-RING	2101537	171,05X3,53 O-RING
2101492	53,97X3,53 O-RING	2101538	177,40X3,53 O-RING
2101493	55,56X3,53 O-RING	2101539	183,75X3,53 O-RING
2101494	56,75X3,53 O-RING	2101540	190,10X3,53 O-RING
2101495	57,15X3,53 O-RING	2101541	196,45X3,53 O-RING
2101496	58,74X3,53 O-RING	2101542	202,80X3,53 O-RING
2101497	59,92X3,53 O-RING	2101543	209,15X3,53 O-RING
2101498	60,32X3,53 O-RING	2101544	215,50X3,53 O-RING
2101499	61,90X3,53 O-RING	2101545	221,85X3,53 O-RING
2101500	63,10X3,53 O-RING	2101546	228,20X3,53 O-RING
2101501	65,10X3,53 O-RING	2101547	234,55X3,53 O-RING
2101502	66,27X3,53 O-RING	2101548	240,90X3,53 O-RING
2101503	66,67X3,53 O-RING	2101549	247,25X3,35 O-RING
2101504	68,26X3,53 O-RING	2101550	253,60X3,53 O-RING
2101505	69,85X3,53 O-RING	2101551	266,30X3,53 O-RING
2101506	71,44X3,53 O-RING	2101552	279,00X3,53 O-RING
2101507	69,44X3,53 O-RING	2101553	291,70X3,53 O-RING
2101508	72,62X3,53 O-RING	2101554	304,40X3,53 O-RING
2101509	73,02X3,53 O-RING	2101555	329,80X3,53 O-RING
2101510	74,60X3,53 O-RING	2101556	355,20X3,53 O-RING
2101511	75,80X3,53 O-RING	2101557	380,60 X3,53 O-RING
2101512	78,97X3,53 O-RING	2101558	405,26X 3,53 O-RING
2101513	82,14X3,53 O-RING	2101559	430,66X3,53 O-RING
2101514	85,32X3,53 O-RING	2101560	18,30X3,60 O-RING
2101515	88,50X3,53 O-RING	2101561	19,80X3,60 O-RING
2101516	91,67X3,53 O-RING	2101562	21,30X3,60 O-RING
2101517	94,84X3,53 O-RING	2101563	23,00X3,60 O-RING
2101518	101,2X3,53 O-RING	2101564	24,60X3,60 O-RING
2101519	104,37X3,53 O-RING	2101565	26,20X3,60 O-RING
2101520	107,54X3,53 O-RING	2101566	27,80X3,60 O-RING
2101521	110,72X3,53 O-RING	2101567	29,30X3,60 O-RING
2101522	113,90X3,53 O-RING	2101568	30,80X3,60 O-RING
2101523	117,07X3,53 O-RING	2101569	32,50X3,60 O-RING
2101524	120,24X3,53 O-RING	2101570	34,10X3,60 O-RING
2101525	123,42X3,53 O-RING	2101571	35,60X3,60 O-RING
2101526	126,60X3,53 O-RING	2101572	37,30X3,60 O-RING
2101527	129,77X3,53 O-RING	2101573	16,81X5,34 O-RING
2101528	132,94X3,53 O-RING	2101574	18,42X5,34 O-RING
2101529	136,12X3,53 O-RING	2101575	24,77X5,34 O-RING

S&P O-RINGS NBR

Codice/Code	Descrizione/Description d1xd2	Codice/Code	Descrizione/Description d1xd2
2101576	27,94X5,34 O-RING	2101625	142,24X5,34 O-RING
2101577	29,51X 5,34 O-RING	2101626	142,88X5,34 O-RING
2101578	31,12X5,34 O-RING	2101627	145,42X5,34 O-RING
2101579	34,29X5,34 O-RING	2101628	146,05X5,34 O-RING
2101581	40,65X5,34 O-RING	2101629	148,60X5,34 O-RING
2101582	43,82X5,34 O-RING	2101630	149,23X5,64 O-RING
2101584	50,16X5,34 O-RING	2101631	151,77X5,34 O-RING
2101585	53,34X5,34 O-RING	2101632	158,12X5,34 O-RING
2101587	59,70X5,34 O-RING	2101633	164,47X5,34 O-RING
2101588	62,87X5,34 O-RING	2101634	170,82X5,34 O-RING
2101589	66,04X5,34 O-RING	2101635	177,17X5,34 O-RING
2101590	69,22X5,34 O-RING	2101636	183,52X5,34 O-RING
2101591	72,40X5,34 O-RING	2101637	189,87X5,34 O-RING
2101592	74,63X5,34 O-RING	2101638	196,22X5,34 O-RING
2101593	75,57X5,34 O-RING	2101639	202,57X5,34 O-RING
2101594	78,74X5,34 O-RING	2101640	208,92X5,34 O-RING
2101595	79,77X5,34 O-RING	2101641	215,27X5,34 O-RING
2101596	81,92X5,34 O-RING	2101642	221,62X5,34 O-RING
2101597	85,10X5,34 O-RING	2101643	227,97X 5,34 O-RING
2101598	88,27X5,34 O-RING	2101644	278,77X5,34 O-RING
2101599	89,69X5,34 O-RING	2101645	291,47X5,34 O-RING
2101600	91,44X5,34 O-RING	2101646	304,17X5,34 O-RING
2101601	94,62X5,34 O-RING	2101647	380,37X5,34 O-RING
2101602	97,80X5,34 O-RING	2101648	405,26X5,34 O-RING
2101603	100,00X5,34 O-RING	2101649	430,66X5,34 O-RING
2101604	100,97X5,34 O-RING	2101650	481,46X5,34 O-RING
2101605	104,14X5,34 O-RING	2101651	113,67X6,99 O-RING
2101606	107,32X5,34 O-RING	2101652	114,70X6,99 O-RING
2101607	109,54X5,43 O-RING	2101653	116,84X6,99 O-RING
2101608	110,50X5,3 4 O-RING	2101654	120,02X6,99 O-RING
2101609	113,67,5,34 O-RING	2101655	123,20X6,99 O-RING
2101610	116,84X5,34 O-RING	2101656	124,60X6,99 O-RING
2101611	117,48X5,34 O-RING	2101657	126,37X6,99 O-RING
2101612	120,02X5,34 O-RING	2101658	129,54X6,99 O-RING
2101613	120,65X5,34 O-RING	2101659	132,72X6,99 O-RING
2101614	123,20X5,34 O-RING	2101660	134,50X6,99 O-RING
2101615	123,83X5,34 O-RING	2101661	135,90X6,99 O-RING
2101616	126,37X5,34 O-RING	2101662	139,07X6,99 O-RING
2101617	127,00X5,34 O-RING	2101663	142,24X6,99 O-RING
2101618	129,54X5,34 O-RING	2101664	145,42X6,99 O-RING
2101619	130,18X5,34 O-RING	2101665	148,60,X6,99 O-RING
2101620	132,72X5,34 O-RING	2101666	151,77X6,99 O-RING
2101621	133,35X5,34 O-RING	2101667	155,60X6,99 O-RING
2101622	135,90X5,34 O-RING	2101668	158,12X6,99 O-RING
2101623	136,53X5,34 O-RING	2101669	159,50X6,99 O-RING
2101624	139,70X5,34 O-RING	2101670	161,90X6,99 O-RING

S&P O-RINGS NBR

Codice/Code	Descrizione/Description d1xd2	Codice/Code	Descrizione/Description d1xd2
2101671	164,47X6,99 O-RING	2101717	98,02X3,53 O-RING
2101672	166,70X6,99 O-RING	2101118	37X1,5 O-RING
2101673	168,30X6,99 O-RING	2101119	58X1,5 O-RING
2101674	170,82X6,99 O-RING	2101132	2X9,5X13,5 O-RING
2101675	174,60X6,99 O-RING	2101137	1X7X9 O-RING
2101676	177,17X6,99 O-RING	2101151	6X3X12 O-RING
2101677	181,00X6,99 O-RING	2101152	81X87X3 O-RING
2101678	183,52X6,99 O-RING	2101153	43X49X3 O-RING
2101679	187,30X6,99 O-RING	2101156	70X94X2 O-RING
2101680	189,87X6,99 O-RING	2101187	13X2X17 O-RING
2101681	193,70X6,99 O-RING	2101231	28X2,5 O-RING
2101682	196,22X6,99 O-RING	2101031	37X5,33 O-RING
2101683	200,00X6,99 O-RING	2101032	46,99X5,33 O-RING
2101684	202,57X6,99 O-RING	2101033	56,52X5,33 O-RING
2101685	208,92X6,99 O-RING		
2101686	215,27X6,99 O-RING		
2101687	221,62X6,99 O-RING		
2101688	227,97X6,99 O-RING		
2101689	234,32X6,99 O-RING		
2101690	240,67X6,99 O-RING		
2101691	247,00X6,99 O-RING		
2101692	253,57X6,99 O-RING		
2101693	259,70X6,99 O-RING		
2101694	266,07X6,99 O-RING		
2101695	272,40X6,99 O-RING		
2101696	278,77X6,99 O-RING		
2101697	285,10X6,99 O-RING		
2101698	291,47X6,99 O-RING		
2101699	304,17X6,99 O-RING		
2101700	316,87X6,99 O-RING		
2101701	329,57X6,99 O-RING		
2101702	342,27X6,99 O-RING		
2101703	354,97X6,99 O-RING		
2101704	367,67X6,99 O-RING		
2101705	380,37X6,99 O-RING		
2101706	393,07X6,99 O-RING		
2101707	405,26X6,99 O-RING		
2101708	417,96X6,99 O-RING		
2101709	430,66X6,99 O-RING		
2101710	443,36X6,99 O-RING		
2101711	456,06X6,99 O-RING		
2101712	468,76X6,99 O-RING		
2101713	481,46X6,99 O-RING		
2101714	494,16X6,99 O-RING		
2101715	506,86X6,99 O-RING		
2101716	63,50X3,53 O-RING		



**NIPPLES DOPPIO MM
MALE-MALE NIPPLES**

CODICE-CODE	MISURA-SIZE
1125008	3/8
1125019	1/8
1125091	1/4
1125092	1/2
1125093	3/4



**NIPPLES RIDOTTO MM
MALE-MALE REDUCED NIPPLE**

CODICE-CODE	MISURA-SIZE
1125014	1/4 - 3/8
1125015	1/8 - 1/4
1125017	3/8 - 1/2
1125044	1/2 - 1/4
1125045	3/8 - 3/4
1125046	1/2 - 3/4
1125047	1" - 1/2
1125048	1/2 - 1"1/4
1125049	3/4 - 1"
1125050	3/4 - 1"1/4
1125051	1" - 1"1/4
1125052	1" - 1"1/2
1125053	1" - 2"
1125054	1"1/4 - 1"1/2



**RIDUZIONE ESAGONALE
HEXAGONAL REDUCTION**

CODICE-CODE	MISURA-SIZE
1125020	3/4 - 3/8
1125043	1" - 1"1/4
1125055	1/8 - 1/4
1125056	1/8 - 3/8
1125057	1/4 - 3/8
1125058	1/4 - 1/2
1125059	3/8 - 1/2
1125060	1/2 - 3/4
1125061	1/2 - 1"
1125062	1/2 - 1"1/4
1125063	1/2 - 1"1/2
1125064	1/2 - 2"
1125065	3/4 - 1"
1125066	3/4 - 1"1/4
1125067	3/4 - 1"1/2
1125068	3/4 - 2"
1125069	1" - 1"1/2
1125070	1" - 2"



RIDUZIONE ESAGONALE F-M
F-M HEXAGONAL REDUCTION

CODICE-CODE	MISURA-SIZE
1125108	1/4 - 1/8
1125109	3/8 - 1/4
1125110	3/8 - 1/2
1125112	1/2 - 3/8
1125113	1/2 - 1/2
1125114	3/4 - 1/2
1125126	3/4 - 3/8



RIDUZIONE ESAGONALE F-F
F-F HEXAGONAL REDUCTION

CODICE-CODE	MISURA-SIZE
1125097	3/8 - 1/2
1125111	3/8 - 3/8



GOMITO F-F
ELBOW JUNCTION F-F

CODICE-CODE	MISURA-SIZE
1125117	1/2 - 1/2
1125118	3/4 - 3/4



RACCORDO TRE VIE OTTONE TEE F-F-F
T HOLDER JUNCTION F-F-F

CODICE-CODE	MISURA-SIZE
1125025	3/8 - 3/8 - 3/8
1125119	1/2 - 1/2 - 1/2
1125120	3/4 - 3/4 - 3/4

SERRAFILETTI PER RACCORDERIA



1143021 Serrafiletti omologato come sigillante per gas e acqua potabile, smontabile e resistente ad urti e vibrazioni.

Caratteristiche tecniche:

Diametro: M24

Gioco max: mm 0,20

Temperatura di impiego: -55 + 150

1143021 Medium strength anaerobic adhesive for thread locking of nuts and bolts of all types that require to be dismantled. Suitable to be used on oily surfaces.

Highly resistant to heat, corrosion, vibrations, water, gas, oils, hydrocarbons and many chemicals.

Technical specifications:

Diameter: M24

Temperature range: -55 + 150

1143013 Loctite 55 è un sottile nastro bianco multifilo, senza trama, di circa 1mm di larghezza per 0.25mm di spessore in grado di sigillare istantaneamente raccordo filettato (fino a 6" di diametro), in plastica e metallo. Sostituisce canapa e nastri in PTFE.

Caratteristiche tecniche:

Sigillatura di componenti filettati, come giunzioni e raccordi per tubi, sigilla fluidi e non fino alla temperatura di 150 °C. È particolarmente adatto in caso di utilizzo immediato dell'impianto e dove vi sia la necessità di un riposizionamento prima dell'uso.

1143013 Loctite 55 is a general purpose threaded pipe and fitting sealant. A non-curing coated multifilament cord that seals out air and other common gases and fluids.

Recommended for sealing metal and plastic tapered pipe fittings up to 4" NPT for use in industrial

applications in aqueous and non-aqueous fluids. Particularly

suitable in threaded assembly applications that require

immediate use and may undergo small readjustments before

use. This product is typically used in applications up to 149 °C.



THREADSEALING-THREADLOCKING



**GHIERA DI RIDUZIONE
REDUCTION METAL RING**

CODICE-CODE	MISURA-SIZE
1125074	3/8 - 1/2
1125075	1/2 - 3/4



**MANICOTTO FF
FEMALE-FEMALE JOINT**

CODICE-CODE	MISURA-SIZE
1125094	1/4
1125095	3/8
1125096	1/2



**TAPPO M
MALE CAP**

CODICE-CODE	MISURA-SIZE
1125098	1/8
1125099	1/4
1125100	3/8
1125101	1/2







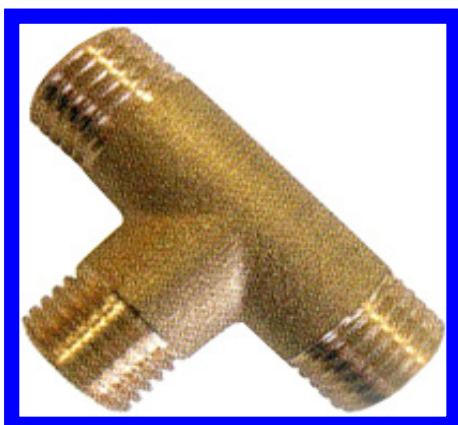





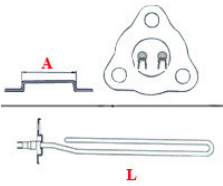

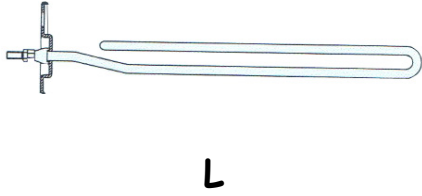

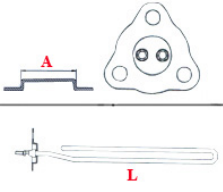

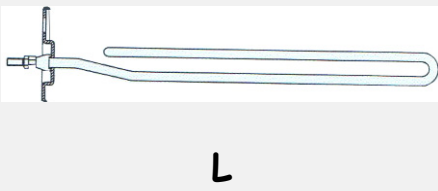
**TAPPO F
FEMALE CAP**

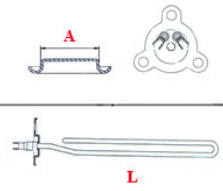

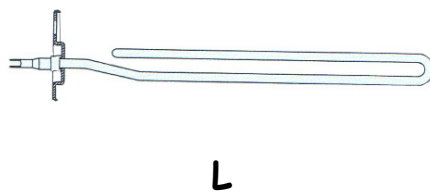

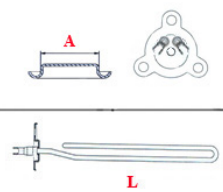

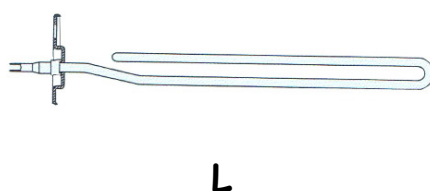



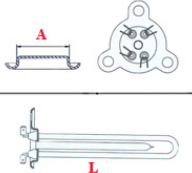

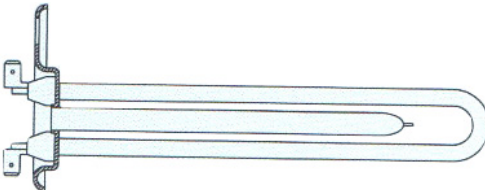
CODICE-CODE	MISURA-SIZE
1125102	1/4
1125103	3/8
1125104	1/2

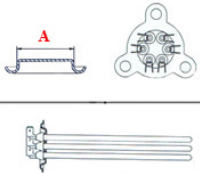

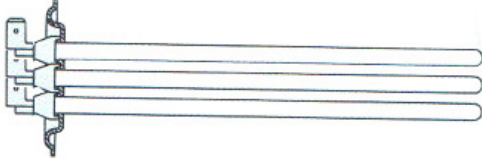

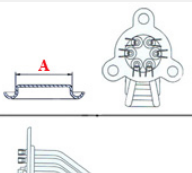

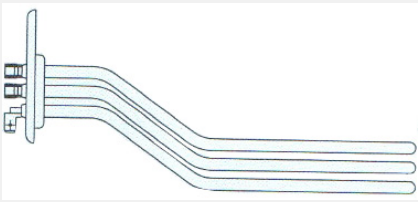



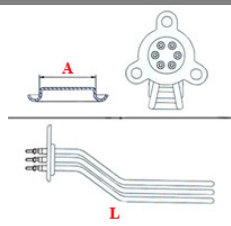

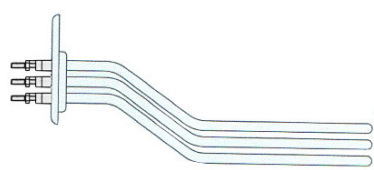

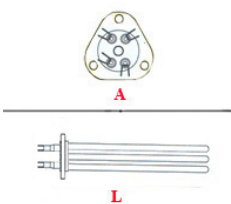



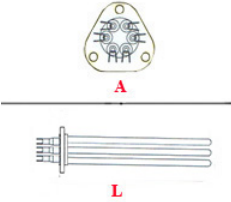

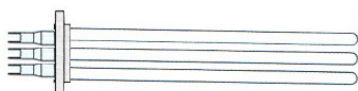
**RACCORDO TRE VIE OTTONE TEE M-M-M
T HOLDER JUNCTION M-M-M**

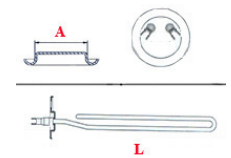





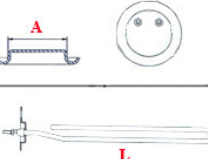
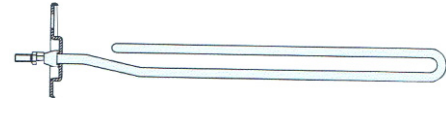



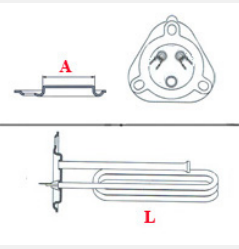

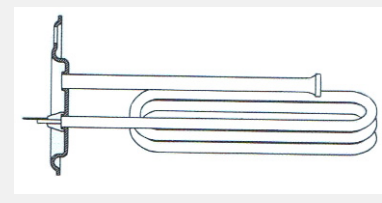

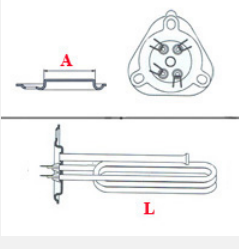
CODICE-CODE	MISURA-SIZE
1125140	1/4 - 1/4 - 1/4
1125141	3/8 - 3/8 - 3/8
1125142	1/2 - 1/2 - 1/2
1125143	3/4 - 3/4 - 3/4

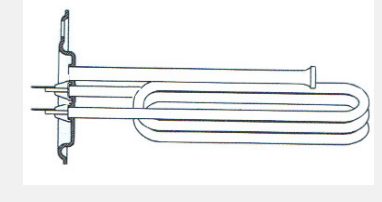

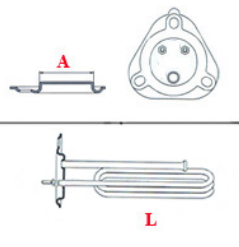

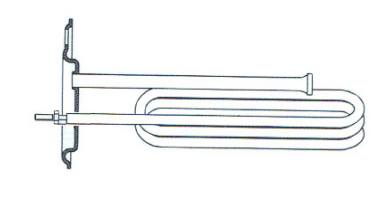

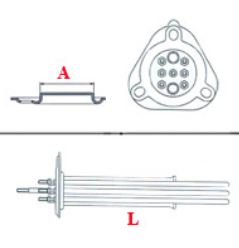

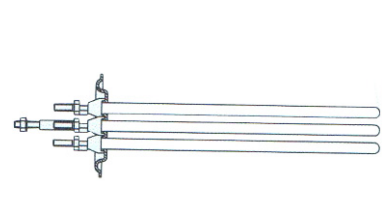

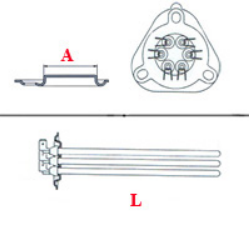

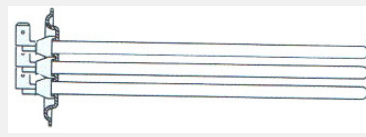
Flangia / Flange Potenza / Watts	Codice / Code	Lunghezza / Length	Guarnizione Gasket
 A=30 mm		 L	
2200 W	1101182	L=240 mm	2101008
2700 W	1101007	L=290 mm	2101008
 A=30 mm		 L	
3000 W	1101101	L=350 mm	2101008
3000 W	1101708	L= 290 mm	2101008
 A=37 mm		 L	
2600 W	1101017	L=290 mm	2101031
2600 W	1101498	L=270 mm	2101031
 A=37 mm		 L	

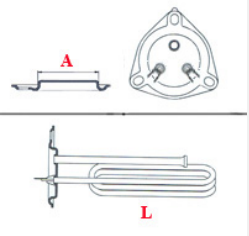

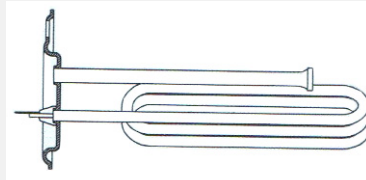

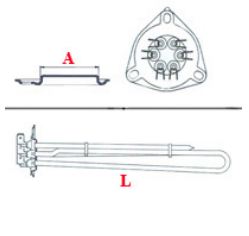

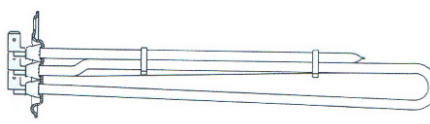



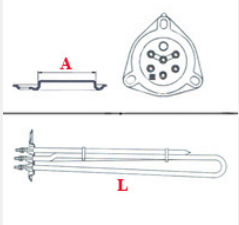

Flangia / Flange Potenza / Watts	Codice / Code	Lunghezza / Length	Guarnizione Gasket
2400 W	1101205	L=250 mm	2101031
2800-3050 W	1101221	L=300 mm	2101031
 A=37 mm		 L	
3000 W	1101120	L=285 mm	2101031
3000 W	1101098	L=300 mm	2101031
 A=37 mm		 L	
4000 W	1101018	L=290 mm	2101031
4000 W	1101298	L=300 mm	2101031
 A=37 mm		 L	
3500 W	1101464	L=370mm	2101031
4500 W	1101078	L=365 mm	2101031
8000 W	1101299	L=540 mm	2101031

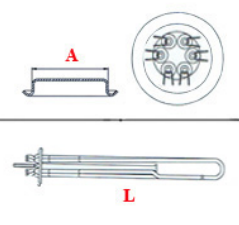



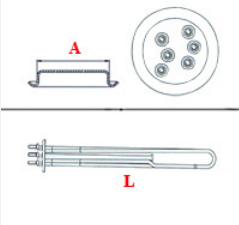





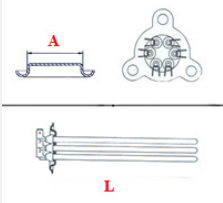



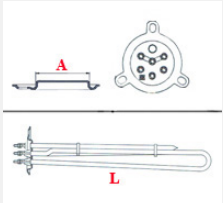

Flangia / Flange Potenza / Watts	Codice / Code	Lunghezza / Length	Guarnizione Gasket
 <p>A=37 mm</p>		 <p style="text-align: center;">L</p>	
6000 W	1101136	L=360 mm	2101031
 <p>A=38 mm</p>		 <p style="text-align: center;">L</p>	
2700 W	1101344	L=290 mm	2102318
 <p>A=38 mm</p>		 <p style="text-align: center;">L</p>	
3990 W	1101322	L=290 mm	2102318
6000 W	1101323	L=365 mm	2102318
 <p>A=47 mm</p>		 <p style="text-align: center;">L</p>	
1500 W	1101469	L=210 mm	2101032
2000 W	1101540	L=270 mm	2101032
2500 W	1101027	L=250 mm	2101032
2800 W	1101425	L=370 mm	2101032

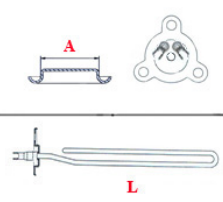



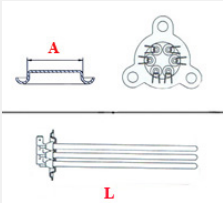



Flangia / Flange Potenza / Watts	Codice / Code	Lunghezza / Length	Guarnizione Gasket
3200 W  A=47 mm	1101144 	L=235 mm  L	2101032 
2500 W  A=47 mm	1101302 	L=200 mm  L	2101032 
2000 W  A=47 mm	1101540 	L=270 mm  L	2101032 
3000 W	1101292	L=270 mm	2101032
4500 W	1101013	L=390 mm	2101032
6000 W	1101362	L=365 mm	2101032
6000 W	1101541	L=355 mm	2101032
6000 W	1101063	L=475 mm	2101032
 A=47 mm		 L	
4500-4900 W	1101491	L=370 mm	2101032
5000 W	1101215	L=250 mm	2101032
6000 W	1101506	L=290 mm	2101032

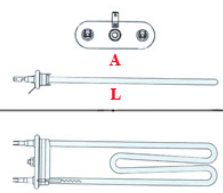

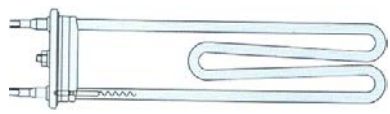
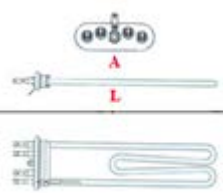

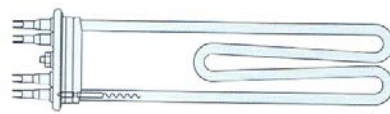
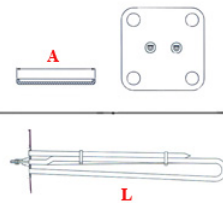
Flangia / Flange Potenza / Watts	Codice / Code	Lunghezza / Length	Guarnizione Gasket
 <p>A=47 mm</p>		 <p>L</p>	
2400 W	1101439	L=220 mm	2101032
2800 W	1101604	L=385 mm	2101032
 <p>A=47 mm</p>		 <p>L</p>	
3200 W	1101217	L=310 mm	2101032
 <p>A=47 mm</p>		 <p>L</p>	
2470 W	1101240	L=200 mm	2101032
2470 W	1101400	L=200 mm	2101032
2500 W	1101405	L=200 mm	2101032
 <p>A=47 mm</p>		 <p>L</p>	
3000 W	1101524	L=260 mm	2101032

Flangia / Flange Potenza / Watts	Codice / Code	Lunghezza / Length	Guarnizione Gasket
4500 W	1101372	L=340 mm	2101032
4500 W	1101539	L=370 mm	2101032
5000 W	1101218	L=260 mm	2101032
6000 W	1101352	L=370 mm	2101032
7600 W	1101898	L=330 mm	2101032
8000 W	1101301	L=360 mm	2101032
9500 W	1101465	L=330 mm	2101032
10200 W	1101867	L=400 mm	2101032
 A=47 mm		 L	
3000 W	1101236	L=165 mm	2101032
4500 W	1101423	L=225 mm	2101032
4500 W	1101771	L=260 mm	2101032
10500 W	1101415	L= 380 mm	2101032
 A=57 mm		 L	
2200 W	1101219	L=230 mm	2101033
3000 W	1101014	L=330 mm	2101033
 A=57 mm		 L	
3000 W	1101893	L=350 mm	2101033
3500 W	1101089	L=350 mm	2101033
4500 W	1101106	L=380 mm	2101033

Flangia / Flange Potenza / Watts	Codice / Code	Lunghezza / Length	Guarnizione Gasket
5000 W	1101509	L=345 mm	2101033
9000 W	1101545	L=450 mm	2101033
9000 W	1101787	L=330 mm	2101033
10500 W	1101481	L=350 mm	2101033
 A=57 mm		 L	
3000 W	1101159	L=350 mm	2101033
4000 W	1101823	L=300 mm	2101033
4200 W	1101158	L=350 mm	2101033
6000 W	1101157	L=250 mm	2101033
6000 W	1101620	L=350mm	2101033
7500 W	1101828	L=410 mm	2101033
8000 W	1101522	L=470 mm	2101033
9000 W	1101827	L=390 mm	2101033
10000 W	1101286	L=480 mm	2101033
12000 W	1101791	L=490 mm	2101033
 A=57 mm		 L	
3800 W	1101596	L=250 mm	2101033
6000 W	1101410	L=460 mm	2101033
 A=57 mm		 L	
6000-6530 W	1101581	L=460 mm	2101033
9000/9800 W	1101531	L=460 mm	2101033

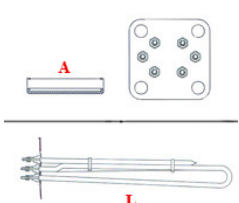
Flangia / Flange Potenza / Watts	Codice / Code	Lunghezza / Length	Guarnizione Gasket
12000/13070W	1101223	L=470 mm	2101033
14000-15240 W	1101514	L=470 mm	2101033
 A=57 mm		 L	
7000 W	1101471	L=350 mm	2101033
5790 W	1101069	L=570 mm	2102134
 A=62 mm		 L	
12000 W	1101672	L=480 mm	2101058
14000 W	1101673	L=480 mm	2101058
 A=62 mm		 L	
2500 W	1101156	L=185 mm	2101058
3000 W	1101243	L=295 mm	2101058
 A=62 mm		 L	
4500 W	1101230	L=270 mm	2101058
6000 W	1101280	L=350 mm	2101058

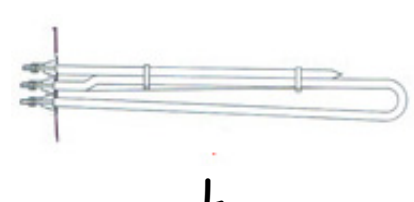
Flangia / Flange Potenza / Watts	Codice / Code	Lunghezza / Length	Guarnizione Gasket
		 <p style="text-align: center;">L</p>	A
1800 W	1101244	L=182 mm	56 mm
1800 W	1101852	L=495 mm	50 mm
2000 W	1101162	L=290 mm	56 mm
3000 W	1101644	L=315 mm	68 mm
3000 W	1101766	L=345 mm	60 mm
3500 W	1101380	L=315 mm	68 mm
1950 W	1101802	L=230 mm	70 mm
2600 W	1101131	L=266 mm	70 mm
2750 W	1101348	L=340 mm	70 mm
2600 W	1101284	L=266 mm	80 mm
		 <p style="text-align: center;">L</p>	A
3000 W	1101757	L=400 mm	80 mm
4000 W	1101570	L=355 mm	70 mm
4000 W	1101815	L=340 mm	70 mm
6000 W	1101845	L=410 mm	80 mm
7600 W	1101294	L=390 mm	80 mm
 <p style="text-align: center;">A=70 mm</p>		 <p style="text-align: center;">L</p>	
3000 W	1101211	L=230 mm	2101030

Flangia / Flange Potenza / Watts	Codice / Code	Lunghezza / Length	Guarnizione Gasket
 A=70 mm		 L	
5700 W	1101057	L=430 mm	2101030
9000 W	1101105	L=320 mm	2101030
9000 W	1101377	L=480 mm	2101030

1101344 RESISTENZ

A 2700W 230V DUE
ELEMENTI /
HEATING ELEMENT
2700W 230V

984076000:

GRUPPO CIMBALI
SPA

9041129EX:

GRUPPO CIMBALI
SPA

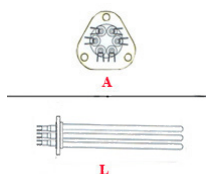

A=38mm, L=290mm,
GASKET= 2102318

1101205 RESISTENZ

A ELETTRICA 2400W
230V /
HEATING ELEMENT
2400W 230V

DW18206:

DIHR-ALI SPA

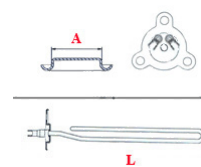

A=38mm, L=250mm,
GASKET= 2101031

1101322 RESISTENZ

A 230 W3990 TER
ELEM. /
HEATING ELEMENT
230 3990W

984142000:

GRUPPO CIMBALI
SPA

9140217EX:

GRUPPO CIMBALI
SPA

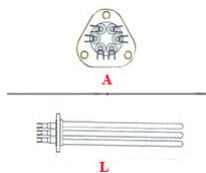

A=38 mm, L=290 mm,
GASKET= 2102318

1101498 RESIST.B.26

00W/230V FL.PICCOLA
P/BULBO /
BOILER HEATING
ELEMENT 2600W/230V

E41:

ELETTROBAR
DIVISIONE DELLA
EUROTEC SRL

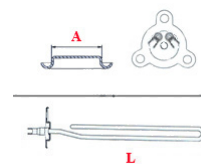

A=37mm, L=270mm,
GASKET= 2101031

1101323 RESISTENZ

A 230V/6000W /
HEATING ELEMENT
230V/6000W

984169000:

GRUPPO CIMBALI
SPA

9141303:

GRUPPO CIMBALI
SPA

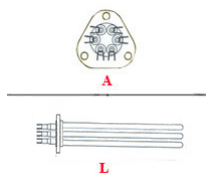

A=38 mm, L=365 mm,
GASKET= 2102318

1101017 RES.BOILER

2600W 230V+OR P/B
7x8 /
BOILER HEATING
ELEMENT 2700W 230V
+OR

905496:

SILANOS SRL

SVELTINA,R20,R20A,
R23A,F19,F19A,F22,F
22A,F28A:

SILANOS SRL

LT155/255,L100/110
/200/220/185/196/R
AINBOX: RANCILIO
SPA

2: BRASILIA SPA

1: UNIVERSALE

10: PROMAC

18010296:

NUOVA SIMONELLI

C35,43,48,STS-:

HOONVED - ALI SPA

E36,E40,E43,C4,C3,T3

,T80:

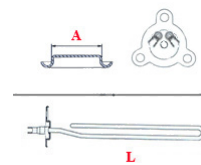

A=37mm, L=290mm,
GASKET= 2101031

1101808 RESISTENZ

A BOILER /
HEATING ELEMENT
BOILER

20069: ADLER S.P.A.

070307:

ELECTROLUX.

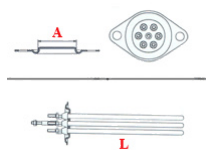

HOONVED - ALI SPA
25360:
HOONVED - ALI SPA

1101221 RESISTENZ
A 2800/3050W 230/240V
L300 /
HEATING ELEMENT
2800/3050W 230/240V
L300
DW18206D:
DIHR-ALI SPA
3030200:
ANGELO PO GRANDI
CUCINE SPA

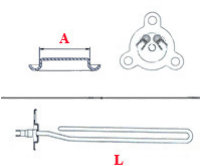

A=38mm, L=300mm,
GASKET= 2101031

1101120 RESISTENZ
A 3000W 230V D.38 2
EL. /
HEATING ELEMENT
3000W 230V D.38 2 EL.
E50,STS43D,DP35D:
HOONVED - ALI SPA
8: CIMBALI

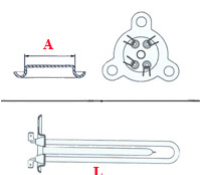

A=38mm, L=285mm,
GASKET= 2101031

1101202 RESISTENZ
A BOILER 3000W LT
285/295 /
BOILER HEATING
ELEMENT 3000W LT
285/295
LT285,295:
RANCILIO SPA

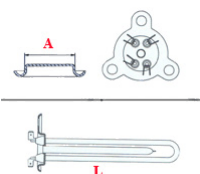

A=38mm, L= 280mm,
GASKET= 2101031

1101098 RESISTENZ
A BOILER 3000W
230V+OR /
BOILER HEATING
ELEMENT 3000W
230V+OR
R29A,F27A,024,030,E
40,V40: SILANOS
SRL
8: UNIVERSALE

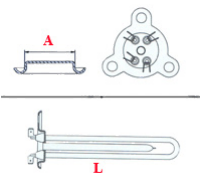

A=38mm, L=300mm,
GASKET, 2101031

1101018 RESISTENZ
A BOILER SAB 4000W /
BOILER HEATING
ELEMENT SAB 4000W
Z100E023:
S.V. ITALIA SRL
LS385,LS395:
RANCILIO SPA
11: PROMAC
2: UNIVERSALE
GS40: DIHR-ALI SPA
T6/80,UNI53/60,IND
Y53/60,UNI53/60:
HOONVED - ALI SPA
34354:
HOONVED - ALI SPA
APS-,APSE-,STS-
C53/60CM52/60,DP-
,NK52/60,INDY53/60
,T5/80:

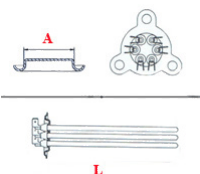

A=38mm, L=290mm,
GASKET= 2101031

HOONVED - ALI SPA

1101298 RESISTENZ
A 4000W /
HEATING ELEMENT
4000W
GS40: DIHR-ALI SPA

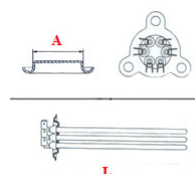

A=38 mm, L=300 mm,
GASKET= 2101031

1101182 RESISTENZ
A BOILER 2200W 230V
MOD. JOLLY /
BOILER HEATING
ELEMENT 2200W 230V
MOD. JOLLY
JOLLY:
OMNIWASH SRL -
SOCIETA' A SOCIO
UNICO

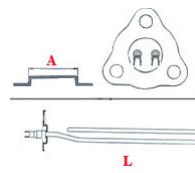

A=30mm, L=240mm,
GASKET= 2101008

1101007 RESISTENZ
A BOILER 2700W 230V /
BOILER HEATING
ELEMENT 2700W 230V
UNO S-CL,DUE CS-CL:
OMNIWASH SRL -
SOCIETA' A SOCIO
UNICO

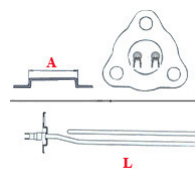
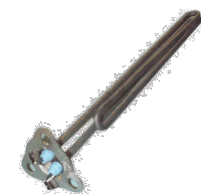

A=30mm, L=290mm,
GASKET= 2101008

1101101 RESISTENZ
A BOILER 3000W/230V
IME /
BOILER HEATING
ELEMENT 3000W 230V
IME
QUATTRO:
OMNIWASH SRL -
SOCIETA' A SOCIO
UNICO

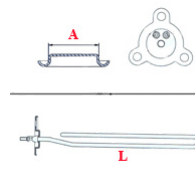

A=31mm, L=350mm,
GASKET= 2101008

1101708 RESISTENZ
A BOILER 3000W/230V
TERM.FILETTATI IME /
BOILER HEATING
ELEMENT 3000W/230V
END THREADED IME
CERB2712:
OMNIWASH SRL -
SOCIETA' A SOCIO
UNICO

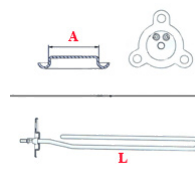

A=30mm, L=290mm,
GASKET= 2101008

1101464 RESIST.
BOILER 3,5 KW 230V /
BOILER HEATING
ELEMENT 3,5KW 230V
905569:
SILANOS SRL

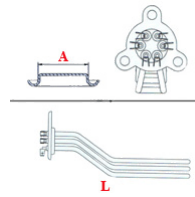

A= 37mm, L= 370mm,
GASKET= 2101031

1101078 RESISTENZ

A BOILER 4500W
230V+OR /
BOILER HEATING
ELEMENT 4500W
230V+OR

E45, E50, V45, V50, 600,
700, 800, 900:

SILANOS SRL

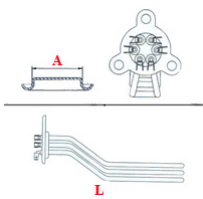

A= 37mm, L= 365mm,
GASKET= 2101031

1101077 RESISTENZ

A BOILER /VASCA
6KW /
BOILER/TANK
HEATING ELEMENT
6KW

1000,1300:

SILANOS SRL

ED650E/S:

HOONVED - ALI SPA

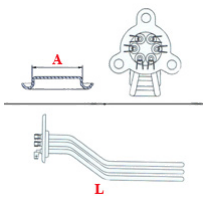

A= 37mm, L= 365mm,
GASKET= 2101031

1101136 RESISTENZ

A BOILER/VASCA
6000W 230V /
BOILER/TANK
HEATING ELEMENT
6000W 230V

1000,1300:

SILANOS SRL

LC100:

ANGELO PO

LC80:

ANGELO PO

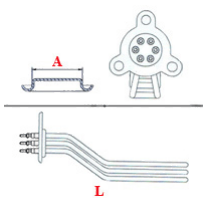

A = 38mm, L = 360mm,
GASKET= 2101031

1101299 RESISTENZ

A VASCA 8KW
230V+OR /
TANK HEATIN
ELEMENT 8KW
230V+O-RING

N7500, N5000:

SILANOS SRL

32G2170:

ANGELO PO

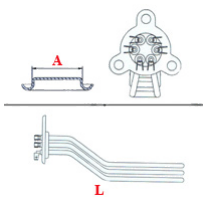

A=38 mm, L=540 mm,
GASKET = 2101031

1101469 RESISTENZ

A 1500W 220V /
HEATING ELEMENT
1500W 220V

7609: A.T.A. SRL

32G0480:

ANGELO PO GRANDI

CUCINE SPA

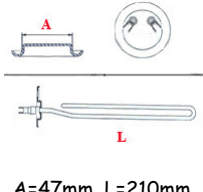

A=47mm, L=210mm,
GASKET= 2101032

1101540 RESISTENZ

A BOILER FLANGIA
TONDA KW 2
BET37/BET40/ERGON /
BOILER HEATING
ELEMENT 2KW
BET37/BET40/ERGON

*: UNIVER-BAR SRL

2010:

UNIVER-BAR SRL

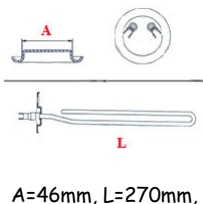

A=46mm, L=270mm,
GASKET= 2101032

1101027 RESISTENZ

A ATA 2500w /
HEATING ELEMENT
ATA 7204

AL03, AL60, AL30,
AL46, AL54, AL55,
AL50, AL10, AL20,
AL05; A.T.A. SRL

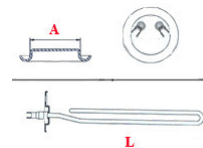

A=47mm, L=250mm,
GASKET= 2101032

1101302 RESISTENZ

A 2500W TURBO
LINEAR /
HEATING ELEMENT
2500W TURBO LINEAR

TURBO, LINEAR,
SYNTHESIS:

DIHR-ALI SPA

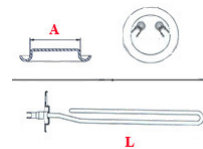

A=47mm, L=200mm,
GASKET= 2101032

1101425 RESIST.2800

/3050W 230/240V 1 /
HEATING ELEMENT
2800/3050W 230/240V 1

DW15089D:

DIHR-ALI SPA

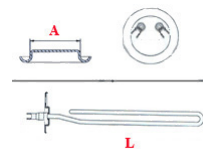

A=47mm, L=370mm,
GASKET= 2101032

1101144 RESISTENZ

A FL. 3200W 230V F20-
BR BC D.48X240L /
BOILER HEATING
ELEMENT 3200W 230V
F20-BR-BC D.48X240L

B-T/TM, B41/42, BC-
BR-, FC34, F20:

COMENDA ALI SPA

1951: MACH

60640N:

SISTEMA PROJECT

STS43/48, DP35/40, C

43/48, SP35/40:

HOONVED - ALI SPA

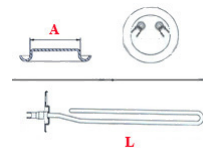

A= 47mm, L=235mm,
GASKET= 2101032

1101292 RESISTENZ

A W3000 3L FL58 /
HEATING ELEMENT
3000W 3L FL58

DW15046:

DIHR-ALI SPA

AL50, AL60, AF73, AF7

8, AT95, AT116:

A.T.A. SRL

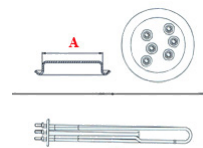

A=48 mm, L=270 mm,
GASKET= 2101032

1101013 RESISTENZ

A 4500W ATA /
HEATING ELEMENT
4500W ATA

AF73, AF88, AF61:

A.T.A. SRL

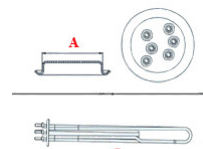

A = 48 mm, L = 370 mm,
GASKET= 2101032

1101491 RESIST.4500
/4900W 230/240V 3 /
HEATING ELEMENT
4500/4900W 230V
GS85: DIHR-ALI SPA

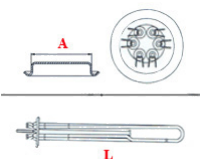

A=47mm, L=370mm,
GASKET= 2101032

1101215 RESISTENZ
A FLANGIA 5000W
230V /
HEATING ELEMENT
5000W 230V
**BC-
HR,BC25HR,BC30HR,B
C30HR380,BC30HRA:
COMENDA ALI SPA**

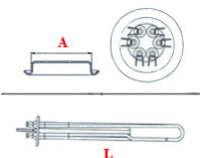

A=47 mm, L=250 mm,
GASKET= 2101032

1101362 RESISTENZ
A 6000W PER AF /
HEATING ELEMENT
6000W FOR AF
5505: A.T.A. SRL

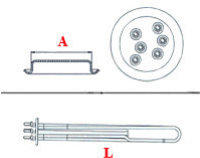

A=47mm, L=365mm,
GASKET= 2101032

1101541 RESISTENZ
A BOILER KW 6 /
BOILER HEATING
ELEMENT 6KW
**4551:
UNIVER-BAR SRL**

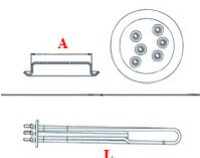

A=46mm, L=355mm,
GASKET= 2101032

1101063 RESISTENZ
A 6000W N.T. ATA 6205
/
HEATING ELEMENT
6000W N.T. ATA 6205
**AT95, AT106:
A.T.A. SRL**

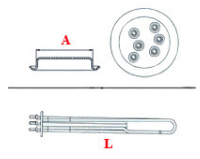

A=47mm, L=475mm,
GASKET= 2101032

1101079 RESISTENZ
A ZANUSSI 051632 /
HEATING ELEMENT
ZANUSSI 051632
**LS1080:
ELECTROLUX
PROFESSIONAL
S.P.A.**

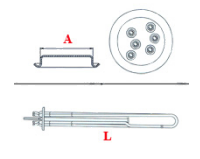

1101506 RESISTENZ
A CON SICUREZZA
400V 6,0 KW /
SAFETY HEATING
ELEMENT 400V 6,0 KW
**2001188: JEMI
3103150ex:
WINTERHALTER
30000234:
WINTERHALTER**

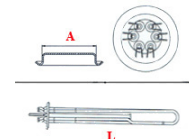

A=47mm, L=290mm,
GASKET= 2101032

1101439 RES. FL
2400W 230V MONO /
HEATING ELEMENT
2400W 230V
**LB275-LB200:
COMENDA ALI SPA**

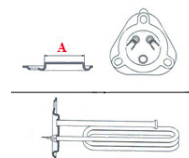

A=47mm, L=220mm,
GASKET= 2101032

1101240 RESISTENZ
A 2470/940W 220/240
LASA /
HEATING ELEMENT
2470/940W 220/240
LASA
**LB99L, LB95L, LB95XL,
LB95H: LASA SRL**

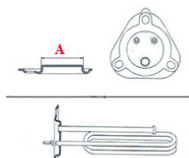

A=48mm, L=200mm,
GASKET= 2101032

1101400 RESISTENZ
A BOILER LASA
LC35/LC40 /
BOILER HEATING
ELEMENT LASA
LC35/LC40
3207000: LASA SRL

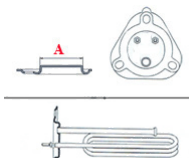

A=48mm, L=200mm,
GASKET= 2101032

1101405 RESISTENZ
A BOILER 2500W
SERIE /
BOILER HEATING
ELEMENT 2500W
L2128: LUXIA SRL

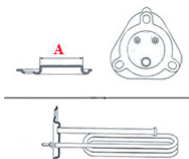

A=47mm, L=200mm,
GASKET= 2101032

1101604 RESISTENZ
A BOILER 2800 W /
BOILER HEATING
ELEMENT 3000W
**049980:
ELECTROLUX
PROFESSIONAL
S.P.A.**

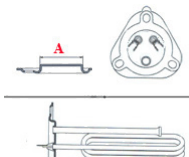

A=47mm, L=385mm,
GASKET= 2101032

1101217 RESISTENZ

A FL 3200W 230V
MONO /
MONOPHASE
HEATING ELEMENT
3200W 230V

BHC25,BHC30:
COMENDA ALI SPA
1953: MACH

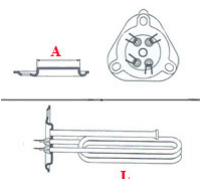

A= 46mm, L=240mm,
GASKET= 2101032

1101081 RESISTENZ

A ZANUSSI 058995
17000W /
HEATING ELEMENT
ZANUSSI 058995

058995:
ELECTROLUX
PROFESSIONAL
S.P.A.

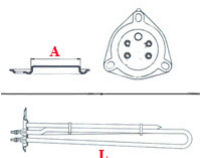

A = 48mm, L = 575mm,
GASKET= 2101032

1101236 RESISTENZ

A BOILER 230V 3KW
165MM /
BOILER HEATING
ELEMENT 230V 3KW
165MM

0L1634:
ELECTROLUX
PROFESSIONAL
S.P.A.

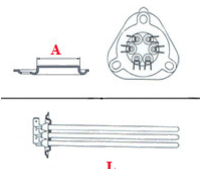

A=47mm, L=165mm,
GASKET= 2101032

1101771 "RESISTENZ

A: 230V 4500W" /
HEATING ELEMENT
230V 4500W

0L2652:
ELECTROLUX
PROFESSIONAL
S.P.A.

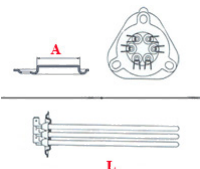

A=47mm, L=260mm,
GASKET= 2101032,

1101524 RESISTENZ

A 3KW 230/380V
L=260MM /
HEATING ELEMENT
3KW 230/380V
L=260MM

230091:
ELETTROBAR
DIVISIONE DELLA
EUROTEC SRL
230116:
ELETTROBAR
DIVISIONE DELLA
EUROTEC SRL

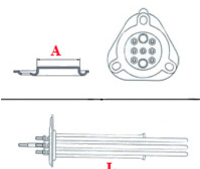

A=46mm, L=260mm,
GASKET= 2101032

1101538 RESISTENZ

A BOILER KW 3 /
BOILER HEATING
ELEMENT 3KW

3010:
UNIVER-BAR SRL

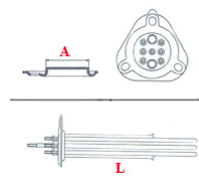

A=46mm, L=265mm,
GASKET= 2101032

1101423 RESISTENZ

A BOILER; 4500W 230V
/

BOILER ELEMENT
4500W 230V

048928:
ELECTROLUX
PROFESSIONAL
S.P.A.

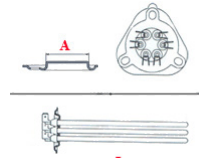

A=47mm, L=225mm,
GASKET=2101032

1101372 RESISTENZ

A 4500W WOLK /
HEATING ELEMENT
4500W WOLK

230081: ELETTROBAR
230013:
ELETTROBAR
DIVISIONE DELLA
EUROTEC SRL

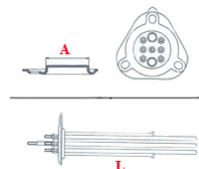

A=46mm, L=340mm,
GASKET= 2101032

1101539 RESISTENZ

A BOILER KW 4,5 /
BOILER HEATING
ELEMENT 4,5KW

3371:
UNIVER-BAR SRL

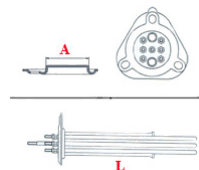

A=46mm, L= 370mm,
GASKET= 2101032

1101218 RESISTENZ

A FL.5000W 230
TRIF.BHC / THREE-
PHASE HEATING
ELEMENT 5000W 230V
BHC

BHC30HR380,
BHC433:
COMENDA ALI SPA
32080100: LASA SRL
230111:
ELETTROBAR
37735:
HOONVED - ALI SPA

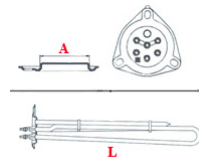

A=46 mm, L=260 mm,
GASKET= 2101032

1101352 RESISTENZ

A 6000W 220V 6545W
240V /
HEATING ELEMENT
6000W 220V 6545W
240V

230083:
ELETTROBAR
048513: ELECTROLUX
46500600:
MODULAR SPA

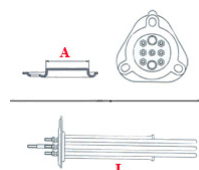

A=46 mm, L=370 mm,
GASKET= 2101032

1101301 RESISTENZ

A 8000W 230/400V /
HEATING ELEMENT
8000W 230/400V

35039900:

BERTO'S SPA

E65,E110,E120,U70,U1

32: ELETTOBAR

62,64,GOLD72:

COLGED

46500700:

MODULAR SPA



A=47mm, L=360mm,
GASKET= 2101032

1101403 RESISTENZ

A BOILER 230V 8800W /
BOILER HEATING
ELEMENT 230V 8800W

3208160: LASA SRL



A=47mm, L=550mm,
GASKET= 2101032

1101465 KIT

RESISTENZA 80398
(9.5KW) /
HEATING ELEMENT
KIT 80398 (9.5KW)

80398C:

ELETTOBAR

DIVISIONE DELLA

EUROTEC SRL



A=47mm, L=330mm,
GASKET= 2101032

1101867 RESISTENZ

A 10200W L=400MM /
HEATING ELEMENT
10200W L=400MM

46501300:

MODULAR SPA



A=47 mm, L=400 mm,
GASKET= 2101032

1101596 RESISTENZ

A CUOCIPASTA
MODULAR 3800W 230V
/

46500000:

MODULAR SPA

66507400:

MODULAR SPA

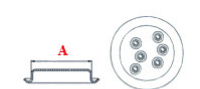

A=57mm, L=250mm,
GASKET= 2101033

1101410 RESISTENZ

A BOILER; 3X2000W
230V /
BOILER HEATING
ELEMENT 3X2000W
230V

OK8249:

ELECTROLUX

PROFESSIONAL

S.P.A.

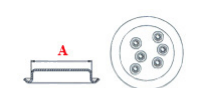

A=57mm, L=460mm,
GASKET= 2101033

1101581 RESIST.6000

/6530W 230/240V 3 /
HEATING ELEMENT
6000/6530W 230/240V 3

DW30001010:

DIHR-ALI SPA



A=57mm, L=460mm,
GASKET= 2101033

1101150 RESISTENZ

A 7000W 230V A.PO
32G1031 /
HEATING ELEMENT

700W 230V A.PO

32G1031

32G1031: ANGELO PO



1101254 RESISTENZ

A 7000W/230V A.PO /
HEATING ELEMENT
A.PO 7000W/230V

32G1160:

ANGELO PO GRANDI

CUCINE SPA



1101255 RESISTENZ

A 7000W/400V A.PO /
HEATING ELEMENT
A.PO 7000W/400V

32G2330:

ANGELO PO GRANDI

CUCINE SPA



1101531 RESIST.9000

/9800W 230/240V 3 /
HEATING ELEMENT
9000/9800W 230/240V

DW30001011:

DIHR-ALI SPA



A=57mm,L=460mm,
GASKET= 2101033,

1101514 RESIST.1400

0/15240W 230/240V 3 /
HEATING ELEMENT
14000/15240W 230/240V
3

DW30001011B:

DIHR-ALI SPA



A=57mm, L=470mm,
GASKET= 2101033

1101533 RESISTENZ

A BOILER 3KW 230 V /
BOILER HEATING
ELEMENT 3KW 230V

DRB32:

ELETTOBAR



1101219 RESISTENZ
A FLANGIA 2200W 230
V / HEATING
ELEMENT 2200W 230V
FC53,FC54L:
COMENDA ALI SPA

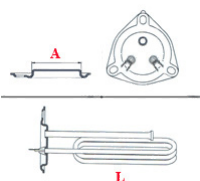

A=57mm, L=230mm,
GASKET= 2101033

1101014 RESISTENZ
A MONOFASE X
BOILER 3000W /
ONE-PHASE BOILER
HEATING ELEMENT
**FC53,FC54,F300,F45,L
F280,LF323:**
COMENDA ALI SPA
OPRA34:
ELECTROLUX
C6E: HOONVED

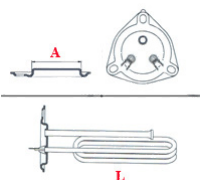

A=57mm, L=330mm,
GASKET= 2101033

1101495 RESISTENZ
A BOILER 2400W 230V /
BOILER HEATING
ELEMENT 2400W 230V
0303001:
LAMBER DI AFFABA
FRANCESCO & C.

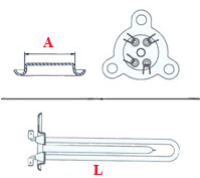

A=57mm, L=230mm,
GASKET= 2101033

1101823 RESISTENZ
A FL57/6,5
4000W.220/380V /
HEATING ELEMENT
FL57 / 6.5 4000W.220 /
380V
37008*:
HOONVED - ALI SPA
110335:
HOONVED - ALI SPA

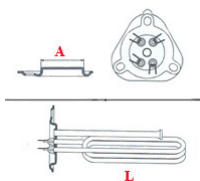

A=57mm, L=300mm,
GASKET=2101033

1101159 RESISTENZ
A 3000W 230/380
D.58X350L /
HEATING ELEMENT
3000W 230/380 D.
58X350L
110226:
COMENDA ALI SPA

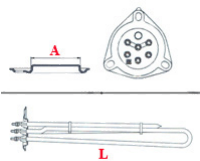

A=57mm, L=350mm,
GASKET= 2101033

1101089 RES. VASCA
3500W 230V MARENO /
TANK HEATING
ELEMENT 3500W 230V
MARENO
LC50,LC65: LASA SRL
MLC50,MLC65:
MARENO

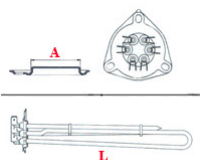

A= 57mm, L= 350mm,
GASKET= 2101033

1101834 RESISTENZ
A CUOCIPASTA 3,8KW
230V /
HEATING ELLEMENT
PASTA COOKER 3.8
KW 230V
66507415:
MODULAR SPA

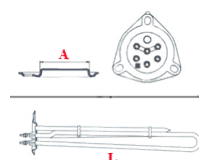

A=57mm,
GASKET= 2101033

1101158 RESISTENZ
A 4500W 380/230V
D.58X350L /
HEATING ELEMENT
4200W 380/230V D.
58X350L
**F2,F3,F55-
F80,LF320,LF323,C30,
C70,C75,C85,L95,LP36
0,G-L,G-:**
COMENDA ALI SPA
25021600:
BERTO'S SPA
36250:
HOONVED - ALI SPA
F85,F92: LAMBER

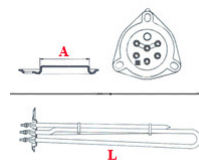

A=57mm, L=350mm,
GASKET= 2101033

1101090 RES.BOILER
4500W 230V /
BOILER HEATING
ELEMENT 4500W 230V
MARENO
MLS30,MLS31:
MARENO
CERB453F:
OMNIWASH SRL

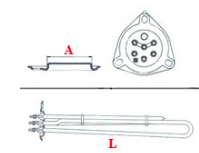

A= 57mm, L= 350mm,
GASKET= 2101033

1101106 RESISTENZ
A BOILER 4500W/3W
230V /
BOILER HEATING
ELEMENT 4500W/3W
230V
QUATTRO
BA/SA61P,62P:
OMNIWASH SRL -
103430: KRUPPS S.R.L.

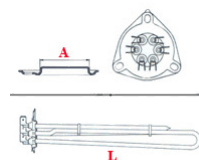

A=57mm, L=380mm,
GASKET= 2101033

1101509 RESISTENZ
A FL.5000W 230/400V
FASTON /
HEATING ELEMENT
5000W 230/400V
FASTON
110332:
COMENDA ALI SPA

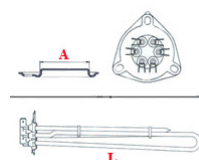

L=345mm, A=57mm,
GASKET= 2101033

1101261 RESISTENZ
A 6000W/400V A.PO /
HEATING ELEMENT
A.PO 6000W/400V
3262310:
ANGELO PO GRANDI
CUCINE SPA

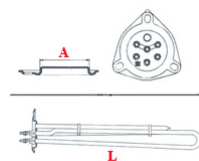

A=57mm,
GASKET=2101033

1101620 RESISTENZ

A 6000W 230/400
FL57XL350 /
HEATING ELEMENT
6000W 230/400
FL57XL350

EDI4:

HOONVED ALI SPA

CERB603F:

OMNIWASH SRL

32G2310: ANGELO PO

110349:

COMENDA ALI SPA

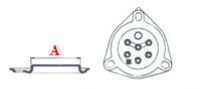

A=57mm, L=350mm,
GASKET= 2101033

1101157 RESISTENZ

A 230/400V 6000W
COMENDA D.58X250L /
HEATING ELEMENT
230/400V 6000W
COMENDA D. 58X390L

6201: A.T.A. SRL

LF350,C33,C34,C75BT

,C75M,C95,C140,LC38

O,LF400,LF450:

COMENDA ALI SPA

F-M,GF-,G-L,G-:

COMENDA ALI SPA

*: MBM

LP-: SILANOS SRL

MLS30P,MLS31P,MLS

35,MLC50:

MARENO INDUSTRIE

ALI SPA

049898:

ELECTROLUX

0H0626:

ELECTROLUX

103432: KRUPPS S.R.L.

R40-40-00002:

VELOX BARCHITTA

ED550-ED650:

HOONVED - ALI SPA

G56,075F,01F,F85,F9

2,L20,L21,015,24L,L25

,P700:

LAMBER

50303250:

LAINOX ALI SPA

LS30,LS31,LS35,LC50:

LASA SRL

R65025100:

LAINOX ALI SPA

R65020270:

LAINOX

LAR65020280:

LAINOX

12024740:

FAGOR

INDUSTRIALE

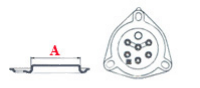

A=57mm, L=250mm,
GASKET= 2101033

1101471 RES.FL.7000

W 230/400V FASTON /
HEATING ELEMENT
7000W 230/400V
FASTON

110333:

COMENDA ALI SPA



A=57mm, L=350mm,
GASKET= 2101033

1101828 RESISTENZ

A 7500W 230V - 9000W
256V 380V /
HEATING ELEMENT
7500W 230V - 256V
9000W 380V



A=57mm, L=410mm,
GASKET= 2101033

1101522 RES.FL.8000

W 230/400V /
HEATING ELEMENT
8000W 230/400V

110343:

COMENDA ALI SPA



A=57mm, L=470mm,
GASKET= 2101033

1101827 RESISTENZ

A 9000W 230/400V /
HEATING ELEMENT
9000W 230 / 400V

12024214:

FAGOR

INDUSTRIALE

CERB903F:

OMNIWASH SRL

OPRQ88:

ELECTROLUX



A=57mm, L=390mm,
GASKET= 2101033

1101545 RESISTENZ

A: 230V-9000W /
HEATING ELEMENT
9000W 230V

OL1630:

ELECTROLUX

PROFESSIONAL

S.P.A.

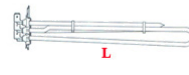

A=57mm, L=450mm,
GASKET= 2101033

1101787 "RESISTENZ

A: 230V 9000W" /
"HEATING ELEMENT;
230V 9000W"

OL2653:

ELECTROLUX

PROFESSIONAL

S.P.A.



A=57mm, L=330mm,
GASKET= 2101033

1101286 RESISTENZ

A 10000W 230/400V
CMND /
HEATING ELEMENT
10000W 230/400V
CMND

C1300E,ACR145,ACR205,ACR225,ACR245,A CR260,ACR265,ACR305:

COMENDA ALI SPA
GMC-
.LV,LVP,NE,NG,NG-E:
COMENDA ALI SPA
27298:

HOONVED - ALI SPA
AC101,AC120,AC122,A
C135,AC150,AC151,AC152,AC170,AC181,AC182:

COMENDA ALI SPA
AC200,AC201,AC202,
AC241,AC242,AC91-
242,AC95-
135,C1000E.;
COMENDA ALI SPA

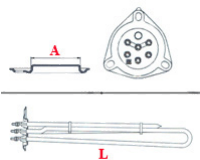

A=56 mm, L=480 mm,
GASKET= 2101033

1101481 RESISTENZ

A 10500W 230V /
HEATING ELEMENT
10500W 230V

049997:

ELECTROLUX.

0L1772ex:

ELECTROLUX.

0L2727:

ELECTROLUX.

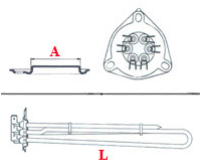

A= 57mm, L= 350mm,
GASKET= 2101033

1101791 RESISTENZ

A FL.12000W.230/400V /
HEATING ELEMENT
FL.12000W.230/400V

113502:

COMENDA ALI SPA

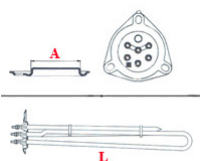

A=57mm,L=490mm,
GASKET=2101033

1101108 RESISTENZ

A W1500X2 220V
C/FLANGIA /
HEATING ELEMENT
W1500X2 220V WITH
FLANGE

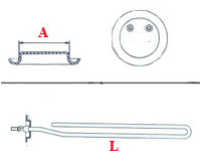

A=62mm, L=300mm,
GASKET= 2101058

1101156 RESISTENZ

A 220V 2500W
C/FLANGIA /
HEATING ELEMENT
220V 2000W WITH
FLANGE

1323: ARISTARCO

PROGRAM25,MINIBA

R: ARISTARCO

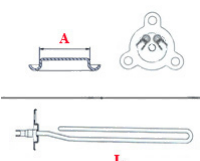

A=62 mm, L=185 mm,

AP35.21,AP38.25,AP40

.28,COMPACT20,MAS

TER22,GEMINI.;

ARISTARCO

GASKET= 2101058

1101243 RESISTENZ

A 230V 3000W /
HEATING ELEMENT
3000W 230V

AP45.30,GL4.32:

ARISTARCO KASTEL
SPA

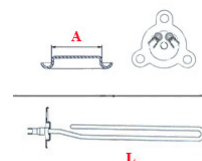

A =62mm, L =295mm,
GASKET= 2101058

1101230 RESISTENZ

A 220V/380V 4500W /
HEATING ELEMENT
220V 4500W

AP50.32,AP50.35,AP50.34,AL50.40,GL1040, GL1240.;

ARISTARCO KASTEL

GL500,GL700,GL5.34,

GL7.38:

ARISTARCO KASTEL

SPA

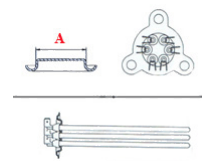

A=62 mm, L=270 mm,
GASKET= 2101058

1101280 RESISTENZ

A 230V 6000W
C/FLANGIA /
HEATING ELEMENT
230V 6000W

GL1040,GL1240:

ARISTARCO KASTEL

SPA

00012101:

ARISTARCO KASTEL

SPA

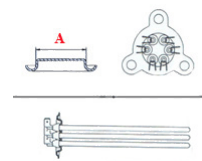

A=62 mm, L=350 mm,
GASKET= 2101058

1101672 RESISTENZ

A 230V 12000W -
C/FLANGIA BOILER 7
FORI /
HEATING ELEMENT
12000W 230V

3405: KRUPPS S.R.L.

3405: ARISTARCO

14803: ARISTARCO

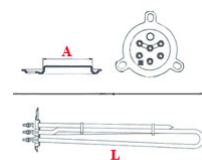

A=62mm, L=480mm,
GASKET=2101058

1101673 RESISTENZ

A 230V 14000W -
C/FLANGIA BOILER 7
FORI /
HEATING ELEMENT
14000W 230V

3406: KRUPPS S.R.L.

00014804:

ARISTARCO KASTEL

SPA

3406:

ARISTARCO KASTEL

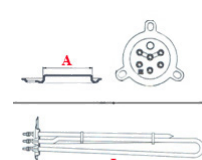

A=62mm, L=480mm,
GASKET=2101058

1101190 RESISTENZ
A 2700W CIMSA /
HEATING ELEMENT
2700W CIMSA
T39I,T39SQ40S,Q45
F,Q45FM: **FABAR SRL**

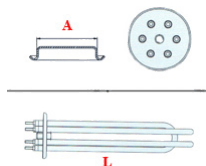

A=96 mm, L =240 mm,
GASKET= 2102220

1101444 RESISTENZ
A 5000W /
HEATING ELEMENT
5000W
10162B: **FABAR SRL**

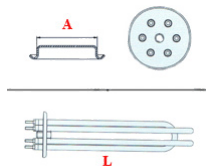

A=100mm, L=350mm,
GASKET= 2102220

1101587 Z201706000
RESISTENZA BOILER
COMPLETA /
Z201706000 COMPLETE
BOILER HEATING
ELEMENT
12024683:
FAGOR
INDUSTRIALE S.R.L.
Z201706000EX:
FAGOR
INDUSTRIALE S.R.L.

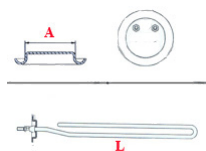

A=60mm, L=425mm,
GASKET= 2101783

1101211 RESISTENZ
A BOILER KW3 /
BOILER HEATING
ELEMENT KW3
00203052:
ELFRAMO SPA
BD11-15:
ELFRAMO SPA

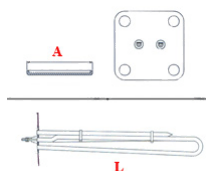

A= 70mm, L=230mm,
GASKET= 2101030

1101057 RESISTENZ
A BOILER 5700W 240V /
BOILER HEATING
ELEMENT 5700W 240V
00003325:
ELFRAMO SPA
MR-,MRC-,MRS-E-
,EC-,ES-,K-: **ELFRAMO**
SPA
D40/80,C44/66,SQ12
0-
SQ240,SQT80,SQ88
5: **ELFRAMO SPA**
00003305:
ELFRAMO SPA
1: **KOMEL**

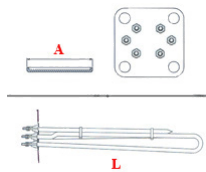
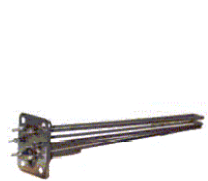

A=70mm, L=430mm,
GASKET= 2101030

1101105 RESISTENZ
A BOILER 9000W 230V /
BOILER HEATING
ELEMENT 9000W 230V
00003349:
ELFRAMO SPA
3: **KOMEL**

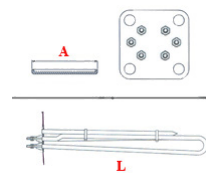

A=70mm, L=320mm,
GASKET= 2101030

1101377 RESISTENZ
A BOILER KW9
C/TERM 220V /
HEATING ELEMENT
BOILER KW9 C / TERM
220V
00003345:
ELFRAMO SPA

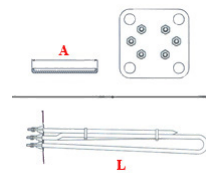

A=70mm, L=480mm,
GASKET= 2101030

1101244 RESISTENZ
A 1800/1960W 230/240V
/
HEATING ELEMENT
1800/1960W 230/240V
TURBO, SYNTHESIS:
DIHR-ALI SPA

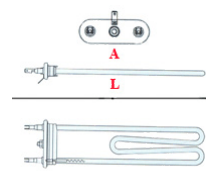

A=55 mm, L=182 mm

1101162 RESISTENZ
A 2000W/230V
FLANGIA ESP. /
EXPANSION FLANGE
HEATING ELEMENT
2000W/230V
DERBY40,DERBY,G35,;
DIHR-ALI SPA

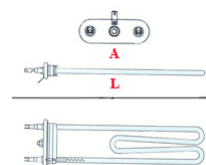

A = 56 mm, L = 290 mm

1101399 "RESISTENZ
A VASCA; 1800W 220V"
/
TANK HEATING
ELEMENT 1800W 220V
060715:
ELECTROLUX
PROFESSIONAL

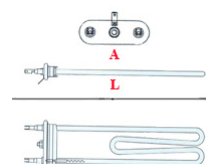

1101644 RESISTENZ
A BOILER 3KW 230V
C/PROT /
BOILER HEATING
ELEMENT 3KW 230V
049756:
ELECTROLUX
PROFESSIONAL

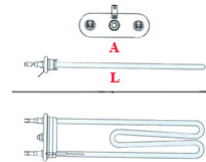

A=68 mm,L=315mm

1101380 "RESISTENZ
A BOILER; 3500W
230V" /
BOILER HEATING
ELEMENT 3500W 230V
049757:
ELECTROLUX
049615:**ELECTROLUX**

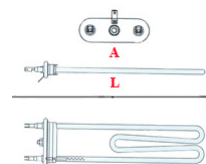

A =68mm, L =315mm

1101815 ELEMENTO
RESISTENZA 4000W /
HEATING ELEMENT
4000W

OE1473:
ELECTROLUX
PROFESSIONAL
S.P.A.

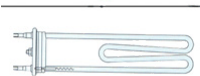
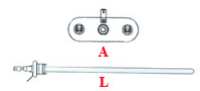

A=70mm, L=340mm

1101570 "RESISTENZ
A: 4KW 230V" /
HEATING ELEMENT
4KW 230V

OE2338:
ELECTROLUX
PROFESSIONAL
S.P.A.

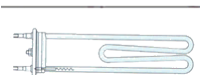
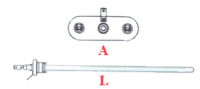

A=70mm, L=355mm

1101845 RESISTENZ
A 6000W 254V /
HEATING ELEMENT
6000W 254V

OE2503:
ELECTROLUX
PROFESSIONAL
S.P.A.

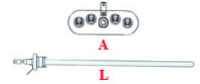

L= 410 mm, A= 80 mm

1101131 RESISTENZ
A BOILER 2600W 230V /
BOILER HEATING
ELEMENT 2600W 230V

E45,45-450:
ELETTROBAR
E35H,E40,E40H,E41,E
42: ELETTROBAR
11-,35-,350-,40-,400-
,E35:
ELETTROBAR
34,40,45,BETA235,BE
TA240,BETA245:
COLGED

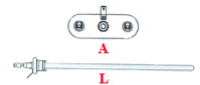

A=70mm, L=266 mm

1101284 RESISTENZ
A BOILER 2600W/230V
/
BOILER HEATING
ELEMENT 2600/230

SILVER40,BETA35-
E40-E41:
ELETTROBAR
DIVISIONE DELLA
EUROTEC SRL
SILVER40,BETA35:
COLGED

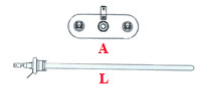

A=80 mm, L=266mm

1101348 RESISTENZ
A 2750W/220V-
3250W/240V PER
LAVABICCHIERI /
HEATING ELEMENT
2750W/220V-
3250W/240V

230088:
ELETTROBAR

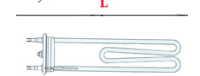
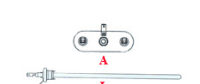

A=70mm, L=340mm

1101294 RESISTENZ
A BOILER
ESP.7600W/400V /
BOILER HEATING
ELEMENT 7600W/400V
230106:

ELETTROBAR
DIVISIONE DELLA
EUROTEC SRL
*:
MBM- EUROTEC SRL -
DIV. COOKING
SERVICE
GOLD55,GOLD57:
COLGED

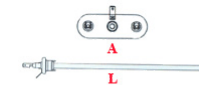

A=81mm, L=390mm

1101398 RESISTENZ
A HOBART HE33
2500W 230V /
HEATING ELEMENT
HOBART HE33 2500W
230V



1101764 IMMERSION
HEATER /
IMMERSION HEATER
01240766101:
HOBART GmbH

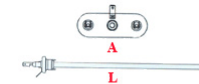

L=330mm, A=50mm

1101757 HEATING
ELEMENT 3KW /
HEATING ELEMENT
3KW
324637-3:
HOBART GmbH



L=400mm, A=80mm

1101766 RESISTENZ
A VASCA 3000W 240V /
TANK HEATING
ELEMENT 3000W 240V
103408: KRUPPS S.R.L.

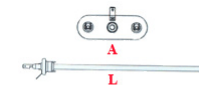

L=345mm, A=60mm

1101852 RESISTENZ
A CORAZZATA
TUBOLARE 240V
W1800W /
HEATING ELEMENT
TUBE 240V W1800W
0078-01.00021A:
PRISMA SRL



A= 50mm, L= 495mm

1101010 RESISTENZ
A 1640W/230V VASCA /
TANK HEATING
ELEMENT 1640W/230V
AP50.32, AP50.35, AP10
40, GL1040, GL1240:
ARISTARCO KASTEL
SPA



H=60mm, L=265mm,
P=30mm, Ø=10mm,
GASKET= 2101378

1101151 RESISTENZ
A 220V 2000W
ARISTARCO /
HEATING ELEMENT
220V 2000W
ARISTARCO
AP35.21, AP38.25, AP40
.28, AP45.30, AP55.40,
GL4.32, PROJET28:
ARISTARCO KASTEL
ARISR005:
S.V. ITALIA SRL



L=260mm, H=30mm,
P=35mm, A= 9mm,
GASKET= 2101378

1101550 RESISTENZ
A 220V 2000W TORCI.
230V 2180W /
HEATING ELEMENT
2000/2180W 220V
312:
ARISTARCO KASTEL
SPA



P=28mm, L=230mm,
Ø=10mm, H=55mm,
GASKET=2101378

1101809 RESISTENZ
A 1000W /
HEATING ELEMENT
1000W
6986: A.T.A. SRL



P= 87 mm, H= 60 mm,
L=170 mm,
GASKET=2101378

1101370 RESISTENZ
A VASCA C W 1500 /
TANK HEATING
ELEMENT 1500W
1102: A.T.A. SRL



L = 330mm, H = 50mm,
P=38mm, Ø=9mm
GASKET=2101378

1101082 RESISTENZ
A 1800W ATA /
HEATING ELEMENT
1800W ATA
AL40, AL45:
A.T.A. SRL



H=55mm, L=31mm,

P=35mm, Ø=10mm
GASKET= 2101378

1101350 RESISTENZ
A VASCA KW1 220V /
TANK HEATING
ELEMENT KW1 200V
00003277:
ELFRAMO SPA



L=210mm, P=69mm,
H=55mm, Ø=11mm

1101712 RESISTENZ
A VASCA 1600W/230V /
TANK HEATING
ELEMENT 1600W/230V
1101712: FABAR



H=60mm, L=270mm,
P=40mm, Ø=10mm,
GASKET= 2101378

1101345 RESISTENZ
A VASCA W 1000 /
TANK HEATING
ELEMENT 1000W
9131709:
GRUPPO CIMBALI
SPA



H=50mm, L=260mm,
P=45mm
GASKET= 2101196

1101824 RESISTENZ
A VASCA SUPER QS
1000W LB VST /
TANK HEATING
ELEMENT SUPER QS
1000W LB VST
0303045:
LAMBER DI AFFABA
FRANCESCO & C.



H=35mm, L=130mm,
P=40mm, Ø=12mm

1101247 RESISTENZ
A VASCA LAMBER /
TANK HEATING
ELEMENT LAMBER
MINIBAR, SUPERBAR
QS, S280, 040F, 050F, S
510, 075F, 01F, F82, F92
: LAMBER DI AFFABA
FRANCESCO & C.



L=200mm, Ø =13mm,
H=65mm, P=40mm

1101318 RESISTENZ
A VASCA 800W 230V
JOLLY /
TANK HEATING
ELEMENT 800W 230V
JOLLY
JOLLY:
OMNIWASH SRL -
SOCIETA' A SOCIO
UNICO



H=42mm, L=330mm,
P=50 mm, Ø=13mm,

GASKET= 2101315

1101006 RESISTENZ
A VASCA 1800W/230V
IME /
TANK HEATING
ELEMENT 1800W/230V
IME
UNO CS-CL,DUE CS-
CL:
OMNIWASH SRL -
SOCIETA' A SOCIO
UNICO

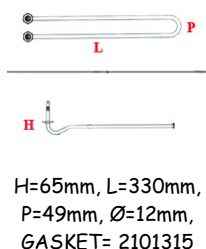

1101016 RES.VASCA
1600W 2F+DADI+OR /
TANK HEATING
ELEMENT 1600W
2F+NUTS+OR
AMBRA,250,SVELTIN
A,024,030,E40,V40 R-
,F-: SILANOS SRL
I: BRASILIA SPA

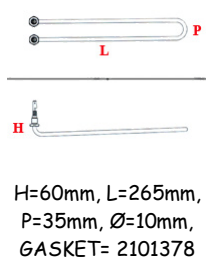

1101171 RESISTENZ
A VASCA 2500W/2
230V+DADI+OR /
TANK HEATING
ELEMENT 2550/2
230V+NUTS+OR
905747EX:
SILANOS SRL
E45,E50,V45,V50:
SILANOS SRL
905575:
SILANOS SRL
DS400,DS401,DS410:
ADLER S.P.A.

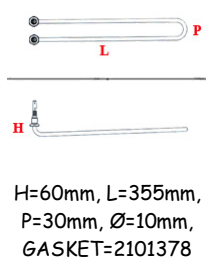
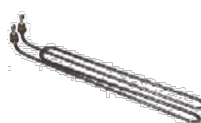

1101152 RESISTENZ
A VASCA 3000W 700
SILANOS /
TANK HEATING
ELEMENT 3000W 700
SILANOS
600,700,800,900,1000
,1300S: SILANOS
SRL

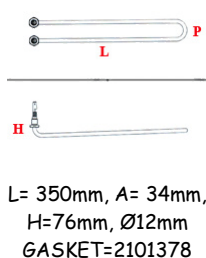

1101762 RESISTENZ
A 230V 1500W DRITTA
/ HEATING ELEMENT
1500W/230V
200: ARISTARCO
KASTEL SPA



1101199 RESISTENZ
A 2000W ATA /
HEATING ELEMENT
2000W ATA
AF61, AF73:
A.T.A. SRL

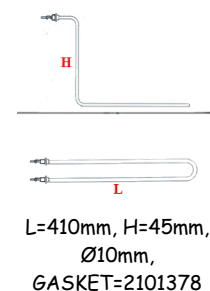

1101805 RESISTENZ
A VASCA 1000W 230V /
HEATING ELEMENT
TANK 1000W 230V
0303044:
LAMBER DI AFFABA
FRANCESCO & C.

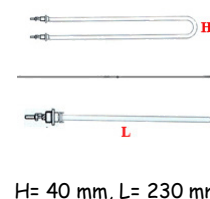

1101184 RESISTENZ
A 2000W 230V
LT105/205 /
HEATING ELEMENT
2000W 230V LT105/205
LT90,LT105,LT205:
RANCILIO SPA

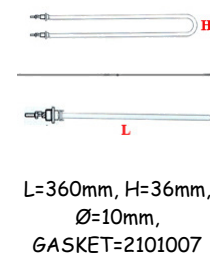

1101455 RESISTENZ
A ALETTATA PER AS
230V-1500W /
HEATING ELEMENT
FINNED - FOR AS 230V-
1500W
110706:
COMENDA ALI SPA

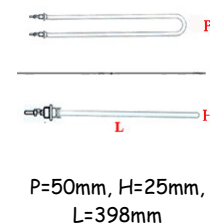

1101532 RESISTENZ
A ASCIUGATURA
2000/2180W 230/240V I /
HEATING ELEMENT
DRYING 2000 / 2180W
230 / 240V I
DW2000359:
DIHR-ALI SPA

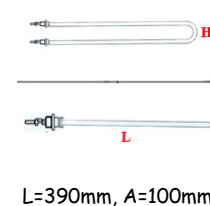

1101083 RESISTENZ
A ALETTATA 1000W
220V /
HEATING ELEMENT
100W 220V
H110704:
HOONVED - ALI SPA
110704:
COMENDA ALI SPA

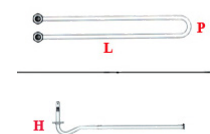

1101608 RESIST. AS
1,5 KW 230V /
HEATING ELEMENT
1,5KW 230V
TR0360:
SILANOS SRL



1101214 RESISTENZ
A VASCA 500W BHC
DUMPER /
TANK HEATING
ELEMENT 500W BHC
DUMPER
BHC30HR,BHC30HR38
0,BHCRA,BHC30HRA3
80,BHCHCR:
COMENDA ALI SPA

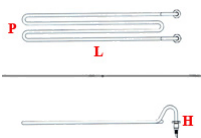
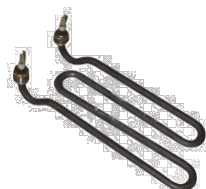

H=28 mm, P=81 mm,
L=220mm, Ø=11mm,
GASKET=2102041

1101422 RESISTENZ
A VASCA; 2200W 230V
/
TANK HEATING
ELEMENT 2200W 230V
048000:
ELECTROLUX
PROFESSIONAL
S.P.A.

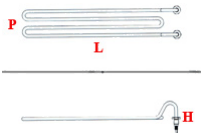

H=40mm, L=330mm,
P=80mm

1101086 RESISTENZ
A X LAV. ZAN.047507 /
DISHWASHER
HEATING ELEMENT
ZANUSSI 047507
047507:
ELECTROLUX
PROFESSIONAL
S.P.A.

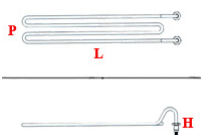

1101085 RESISTENZ
A VASCA 2050W/220V /
TANK HEATING
ELEMENT 2050W 220V
230006:
ELETTROBAR
DIVISIONE DELLA
EUROTEC SRL
230044:
ELETTROBAR
11-,50-500-
E41,E42,E45:
ELETTROBAR
42,45,BETA245:
COLGED
LTB11,LTB12:
ELECTROLUX
PROFESSIONAL.

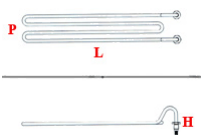

H= 40mm, L= 300mm,
P= 90mm, Ø= 10mm,
GASKET= 2101378

1101351 RESISTENZ
A VASCA 3000W 230V /
TANK HEATING
ELEMENT 3000W 230V
80677ex:
ELETTROBAR
DIVISIONE DELLA
EUROTEC SRL

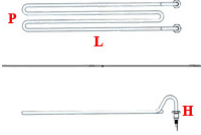

H=50mm, L=320mm,

70562:
ELETTROBAR
LP92:
ELETTROBAR

GASKET=2101378,
P=55mm

1101390 RESISTENZ
A VASCA 3000 W 230N
/
TANK HEATING
ELEMENT 3000W 230V
41211:
ELETTROBAR
DIVISIONE DELLA
EUROTEC SRL

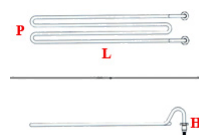

P=78mm, H=70mm,
L=385mm, Ø=10mm,
GASKET=2101378

1101267 RESISTENZ
A VASCA KW2 /
TANK HEATING
ELEMENT KW2
BD-,D30,D40,BD13:
ELFRAMO SPA

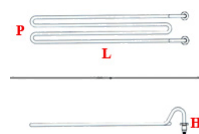

L=305mm, Ø=13mm,
H=55mm, P=80mm

1101227 RESISTENZ
A VASCA KW2.8 230V /
TANK HEATING
ELEMENT KW2.8 230V
D80,C44,C66:
ELFRAMO SPA

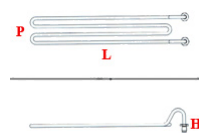
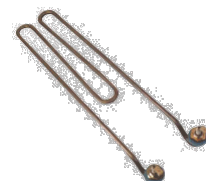

H=56 mm, L=350 mm,
P=80 mm

1101165 RESISTENZ
A VASCA 2000W 230V
RAC.INOX /
TANK HEATING
ELEMENT 2000W 230V
110273:
HOONVED - ALI SPA
110273:
COMENDA ALI SPA
C43:
HOONVED - ALI SPA
60BT,60BT3*,C53DE,
C533,C6,C60DE,C60E,
C68E,C6DE,C6E:
HOONVED - ALI SPA

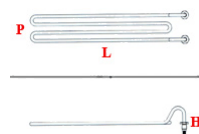
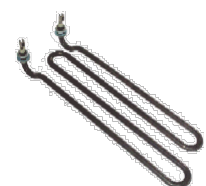

H=45mm, L=285mm,
P=90mm, Ø=12mm,
gasket 2102041

1101426 RESISTENZ
A VASCA 2000W SERIE
K /
TANK HEATING
ELEMENT 2000W
K1300
L2127: LUXIA SRL

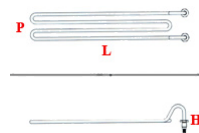

1101278 RESISTENZ

A VASCA PER
LAVABICCHIERI
1000/1200W /
TANK HEATING
ELEMENT

230077:

ELETTROBAR

30630:

SISTEMA PROJECT
SERVICE SRL

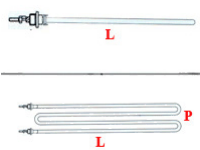

L=145mm, P=45mm,
GASKET=2101378

1101461 RESISTENZ

A ALETTATA KW1,4
230V /
HEATING ELEMENT
KW1,4 230V

EN, ET, ETA:

ELFRAMO SPA

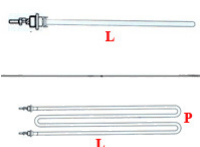

1101100 RESIST.VAS

CA.1500W 230V
LAVABIC /
TANK HEATING
ELEMENT 1500W 230V

LBR-,LBC-,F20:

COMENDA ALI SPA

B10-B42,B-T/TM:

COMENDA ALI SPA

2: FAEMA

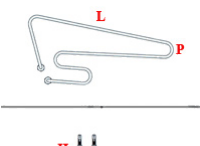

L=300mm, H=40mm,
P=70mm, Ø=9mm.
GASKET=2101378

1101245 RESIST.

VASCA 2000W PER
BHC /
TANK HEATING
ELEMENT 2000W FOR
BHC

C46D,C46DE,C35,C43I
I,C46E:

HOONVED - ALI SPA

LB215/A, LB275/A, LB2

00,BHC25/A,BHC30/A

,BHC433/AL,B260:

COMENDA ALI SPA

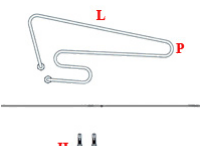

L=315mm, Ø=12mm,
H=70mm, P=110mm,
gasket 2102041

1101124 RESISTENZ

A VASCA 2000W 230V
FC /
TANK HEATING
ELEMENT 2000W 230V
FC

FC-,LF-,F-,M:

COMENDA ALI SPA

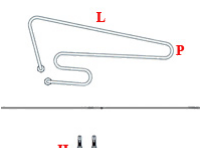

L=350mm, P=140mm,
H=60mm, Ø=8mm.
GASKET=2101378

1101419 RESISTENZ

A VASCA 2000W 440V /
TANK HEATING
ELEMENT 2000W 440V

110265:

COMENDA ALI SPA

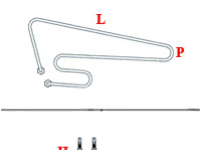

1101148 RESISTENZ

A VASCA 2700W 220V
3200W 240V 22/44/50 /
TANK HEATING
ELEMENT 2700W 220V
3200W 240V 22/44/50

230060:

ELETTROBAR

REB230060: COLGED

230086:

ELETTROBAR

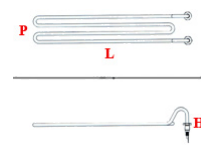

P=77 mm, H=25 mm,
L=380 mm, Ø= 16 mm
GASKET=2101378

1101196 RESISTENZ

A VASCA 2000W /
TANK HEATING
ELEMENT 2000W

F580: FAEMA

SP60,RB,RS,RSD,P,NP,

NPD:

GRUPPO CIMBALI

SPA

FS6,F3E,F3A,F5E,F5A

,KSD: CIMBALI

984087000:

GRUPPO CIMBALI

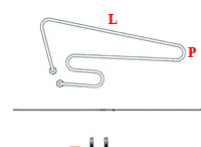
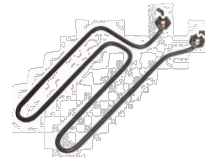

L = 245mm, Ø 12mm, H
=55mm, A= 120mm,
gasket=2101007

1101073 RESISTENZ

A VASCA IME 2500W /
TANK HEATING
ELEMENT IME 2500W

CERV22R:

OMNIWASH SRL

QUATTRO Q:

OMNIWASH SRL

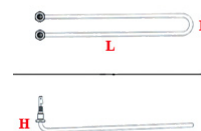

H= 43mm, L= 450mm,
P=52mm, Ø=12 mm,
GASKET= 2101007

1101025 RESISTENZ

A VASCA LT110 2000W
/

TANK HEATING
ELEMENT LT110
2000W

13: PROMAC

LT100,110,200,220,RA

INBOX

LT105,205,155,255:

RANCILIO SPA

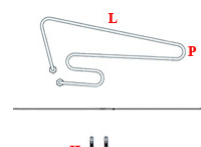
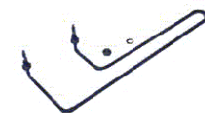

P=111mm,
L=390mm, Ø=9mm,
GASKET= 2101378

1101071 RESISTENZ

A V 230 3000W /
HEATING ELEMENT
230V 3000W

LS400/440,LS600/66

0:

RANCILIO SPA

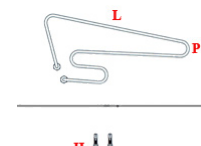

A = 40 mm, H = 35 mm,
L= 480 mm, Ø = 15 mm,
3000 W,
GASKET=2101378

1101233 RESISTENZ

A ESP. 1275W 230V BC BR / TANK HEATING ELEMENT 1275W 230V BC BR

BR25:

COMENDA ALI SPA

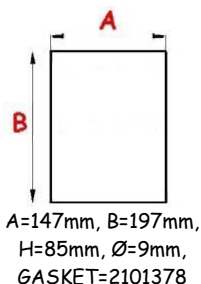

1101611 RESISTENZ

A VASCA 1000W / TANK HEATING ELEMENT 1000W

46501200:

MODULAR SPA

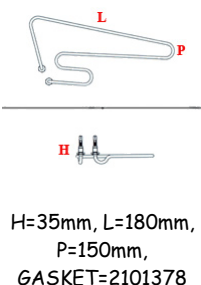

1101566 RESISTENZ

A VASCA SAMMIC 1500W / TANK HEATING ELEMENT SAMMIC 1500W

2309746: SAMMIC

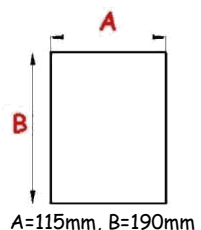

1101143 RESISTENZ

A FLANGIA ESPANS. 3000W 230/400V L400 / EXPANSION FLANGE HEATING ELEMENT 3000W 230/240V L400 F2/3/300,C30,C70-C166,LP-,LC-,GF-:

COMENDA ALI SPA

110228ex:

COMENDA ALI SPA

ED550,ED650E/S,CA9

O,CA120:

HOONVED - ALI SPA

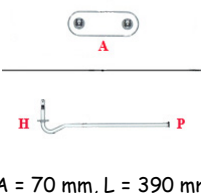

1101295 RESISTENZ

A 1850 W / HEATING ELEMENT 1850W

LINEAR,

GS35,GS37,GS40,GAS

TRO450,GS100,TEKN

O6.: DIHR-ALI SPA

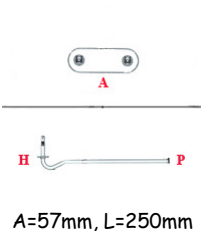
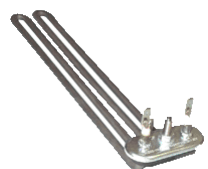

1101305 RESISTENZ

A 2700/2940W 230/240V / HEATING ELEMENT 2700/2940W 230/240V

DW150047:

DIHR-ALI SPA

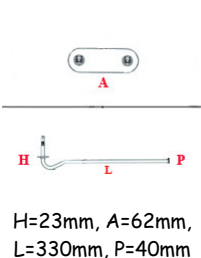

1101059 RESISTENZ

A 230V 2200W ZANUSSI 048924 / HEATING ELEMENT 230V 2 ZANUSSI 048924

OL2340:

ELECTROLUX

LS3:

ELECTROLUX.

048228:

ELECTROLUX

PROFESSIONAL

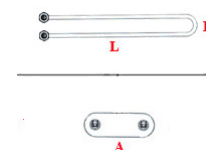

1101546 RESISTENZ

A: 230V-3000W / HEATING ELEMENT 3000W 230V

OL1870:

ELECTROLUX

PROFESSIONAL

S.P.A.

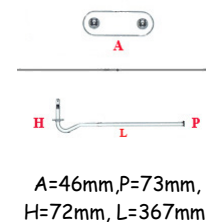

1101580 RESISTENZ

A VASCA / TANK HEATING ELEMENT

OL2109:

ELECTROLUX

PROFESSIONAL

S.P.A.

049954:

ELECTROLUX

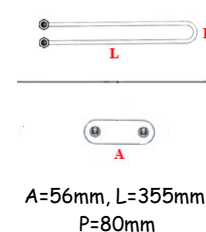

1101075 RESIST.

VASCA 600W ELETTOBAR / TANK HEATING ELEMENT 600W ELETTOBAR

E35,E35H,E40,E40H:

ELETTOBAR

SILVER40,BETA235,

BETA240: COLGED

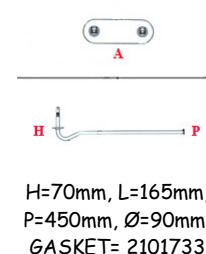

1101601 RESISTENZ

A VASCA 2050W/220V 2450W/240V / TANK RESISTANCE 2050W/220V 2450W/240V

230103:

ELETTOBAR

DIVISIONE DELLA

EUROTEC SRL

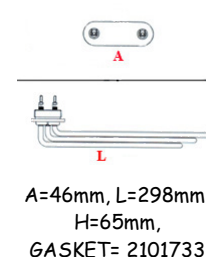

1101588 Z733601000

RESISTENZA VASCA / Z733601000 TANK HEATING ELEMENT

Z733601000EX:

FAGOR

INDUSTRIALE S.R.L.

12024986:

FAGOR

INDUSTRIALE S.R.L.

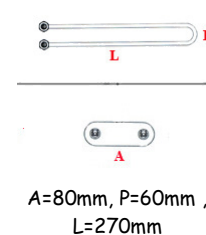

1101516 Z203601000
RESISTENZA VASCA
2800W 230V /
Z203601000 TANK
HEATING ELEMENT
2800W 230V

Z203601:
FAGOR
INDUSTRIALE S.R.L.
Z203601000EX:
FAGOR
INDUSTRIALE S.R.L.
12024645:
FAGOR
INDUSTRIALE S.R.L.

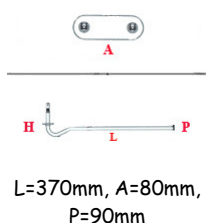

1101276 RESISTENZ
A VASCA 2KW
230V+DADI+OR /
TANK HEATING
ELEMENT 2KW 230V
905858:
SILANOS SRL

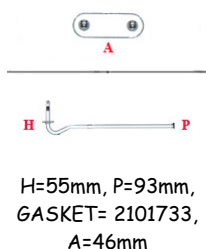

1101163 RESISTENZ
A VASCA TEIKOS
2700W/230V /
TANK HEATING
ELEMENT TEIKOS
2700W 230V
843501: TEIKOS SRL

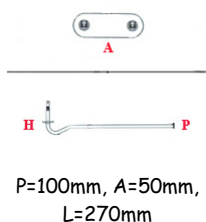

1101560 RESISTENZ
A VASCA KW 2
LAVABICCHIERI /
TANK HEATING
ELEMENT 2 KW
1532:
UNIVER-BAR SRL

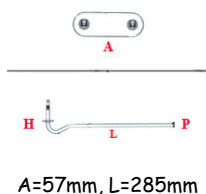

1101220 RESISTENZ
A 1100/1200W 230/240V
/
HEATING ELEMENT
1100/1200W 230/240V
TEKNO4:
DIHR-ALI SPA

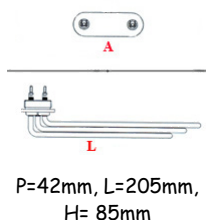
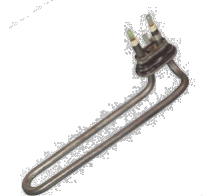

1101574 RESISTENZ
A VASCA NEOTECH /
TANK HEATING
ELEMENT NEOTECH
230112:
ELETTROBAR
DIVISIONE DELLA
EUROTEC SRL

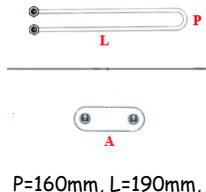

H=40mm, A=50mm,
GASKET= 2101733

1101404 RESISTENZ
A VASCA L=200 230V
800W /
TANK HEATING
ELEMENT L=200 230V
800W
3208280: LASA SRL

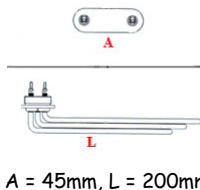

1101103 RESISTENZ
A VASCA 5700W 240V /
TANK HEATING
ELEMENT 5700W 240V
SQ120-
SQ249,SQ885,,SQR8
0,MR-,MRC-:
ELFRAMO SPA
MRS-,E-,EC-,ES-,K-:
ELFRAMO SPA
DW10300022:
DIHR-ALI SPA

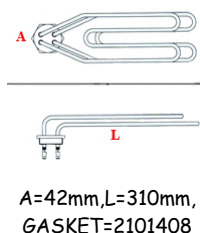

1101346 RESISTENZ
A VASCA NP 80-100-
120 /
TANK HEATING
ELEMENT NP 80-100-
120
9141101:
GRUPPO CIMBALI
SPA

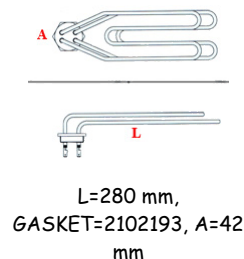

1101023 RESIST.VAS
CA 62P 4500W/3 /
TANK HEATING
ELEMENT 62P 4500W/3
CERV453FR:
OMNIWASH SRL -
SOCIETA' A SOCIO
UNICO

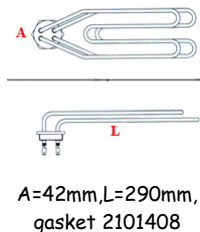

1101001 RESISTENZ
A VASCA 1105
3900W/230V / TANK
HEATING ELEMENT LS
1105 3900W/230V
905571: SILANOS
SRL
CF70,CF1000,DS1200,
A720,A1080,F1201:
ADLER S.P.A.
LS1105,805,705:
RANCILIO SPA

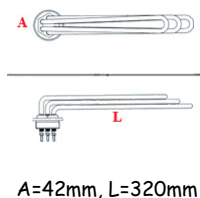

1101496 RESISTENZ
A VASCA 2500 W PER
LAV. CAPOT. /
TANK HEATING
ELEMENT 2500W
103450: KRUPPS S.R.L.

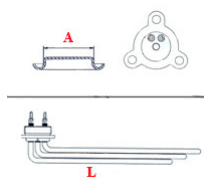

L=310mm, A=37mm,
GASKET= 2101031

1101754 Resistenza
vasca KW 2 230 V flangia
tonda /
Tank heating element KW
2 - 230V round flange
4599:
UNIVER-BAR SRL

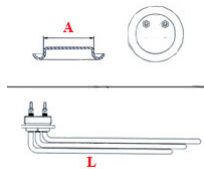

A=47mm ,L=272mm,
P=36mm,
GASKET=2101032

1101373 RESIST.2700
/2940W 230/240V 3 /
HEATING ELEMENT
2700/2940W 230/240V
DW15047A: DIHR-
ALI SPA
4552: UNIVER-BAR
SRL

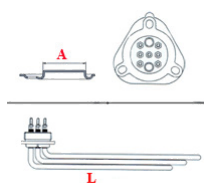

L=250mm, A=47mm,
GASKET= 2101032

1101142 RESISTENZ
A VASCA 4500W LASA
/ TANK HEATING
ELEMENT 4500W LASA
3208090: LASA SRL

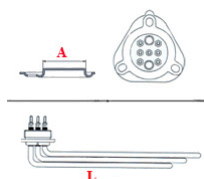

A=47mm, L=300mm,
GASKET= 2101032

1101819 RESISTENZ
A VASCA PER
LAVAPIATTI A CAPOT
4500W 230V/380V /
HEATING ELEMENT
TANK FOR A
DISHWASHER CAPOT
4500W 230V / 380V
103451: KRUPPS S.R.L.

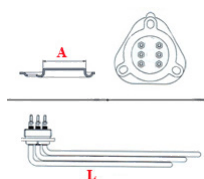

A=57mm,L=280mm,
GASKET=2101033

1101316 RESISTENZ
A VASCA 2000W - 230V
/ TANK HEATING
ELEMENT 2000W -
230V
25370:
HOONVED - ALI SPA



1101578 RESISTENZ
A A TAPPO DA 1"1/4
2000 W /
"HEATING ELEMENT
1"1/4 200W"
10162X: FABAR SRL

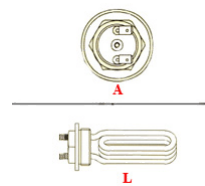

A=41mm, L=300mm,
gasket=2107147

1101409 RESISTENZ
A FABAR 1000W /
HEATING ELEMENT
1000W 230V FABAR
10163: FABAR SRL

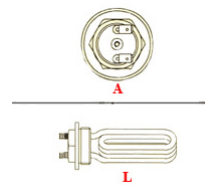

A = 26mm,L = 220mm,
gasket=2101475

1101232 RESISTENZ
A VASCA 800W 220V /
TANK HEATING
ELEMENT 800W 220V
25368:
HOONVED - ALI SPA

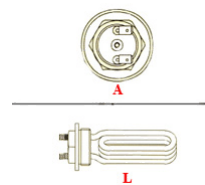

A=32mm, L= 210mm

1101567 RESISTENZ
A LIVELLO ACQUA
PENTOLA /
HEATING ELEMENT
BOILING POT
CRO682160R:
MARENO INDUSTRIE
*: MARENO
CRO682160R: SILKO

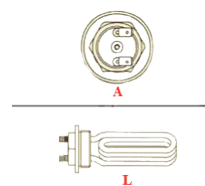

A=33mm, L=230mm

1101603 RESIST. X
BOILER RICURVA
ATT. / BOILER
HEATING ELEMENT

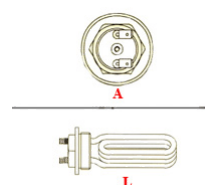

1101584 RESIST.TRIF
ASI 2500W 220-380V /
HEATING ELEMENT
2500W 220-380V

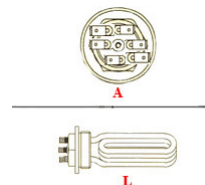

A=2", L=330mm

1101807 KIT
RESISTENZA VASCA
RV 50 +PASTA
CONDUTTIVA /
HEATING ELEMENT
KIT TANK RV 50+
CONDUCTIVE PASTE
999206:
ELETTOBAR
DIVISIONE DELLA



1101326 RESISTENZ

A VASCA NAP 43-45 /
TANK HEATING
ELEMENT NAP 43-45

NAP 43-45:

GRUPPO CIMBALI
SPA

984094000:

GRUPPO CIMBALI
SPA



4119147 RESISTENZ

A ASSEMBLATA 230V
50HZ CIOCCOLATIERA
3 LT /
HEATING ELEMENT
ASSEMBLY 230V 50HZ
FOR CHOCOLATE
MACHINE 3 LT

3350000100:

UGOLINI SPA



1101869 RESISTENZ

A VASCA 2000W 230V
(LC411) /
TANK HEATING
ELEMENT 2000W-230V

110291:

COMENDA ALI SPA

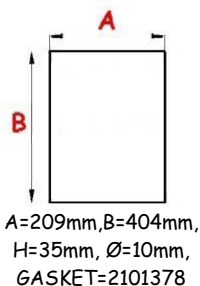

1101273 RESISTENZ

A A TUBO 2,8KW 230V
WINTERHALTER /
HEATING ELEMENT
2,8KW 230V
WINTERHALTER

GS24:

WINTERHALTER
ITALIA SRL

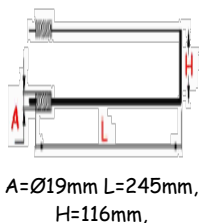
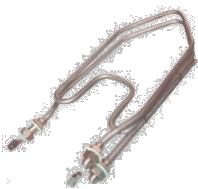

1101623 RESISTENZ

A 230V/1 /
HEATING ELEMENT
230V/1

61005231:

WINTERHALTER
ITALIA SRL

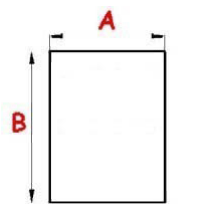

1103001 POMPA 0,10

HP MANDATA DX /
ANTICLOCKWISE
PUMP 0,10 HP
COMPACT20,PASSPO
RT35.21,MASTER21.2

2,MINIBARCF/CR:

ARISTARCO SPA

U61,U61H:

ELETTROBAR

1103001:

S.V. ITALIA SRL

1103001:



UNIVERSALE

DPE11: COLGED

EA001: OEM ALI SPA

EA009: OEM ALI SPA

1103179 POMPA KW

0,073 /0,10 HP220/240 /
WATER PUMP KW

0,073 /0,10 HP220/240

FC-BT, C-BT, LP-BT,

LC-BT:

COMENDA ALI SPA



1103018 POMPA

0,15HP DX /

ANTICLOCKWISE

PUMP 0,15HP

1103018: TEIKOS SRL

130108-130097:

COLGED

1103018:

UNIVERSALE

LB99L, LB95L, LB95XL,

LB95H: LASA SRL

DRAIN

C43, 48, 98, EDI13, EDI

6, EDI8: HOONVED -

ALI SPA

3823: UNIVER-BAR



1103165 POMPA 0,20

HP 230/1/50 CESTO

QUADRO /

PUMP 0,20HP 230/1/50

SQUARE BASKET

T172: ELETTROBAR

130108: ELETTROBAR

130097: ELETTROBAR

902228:

SILANOS SRL

F19, F19A, F22, F22A,

F28A: SILANOS SRL

LT90, LT155, LT255, LT

205, LT105:

RANCILIO SPA



1103342 POMPA ATA

HP 0,20 V230 28/12 /

PUMP ATA 0,20HP 230V

28/12

1511: A.T.A. SRL

1530: A.T.A. SRL

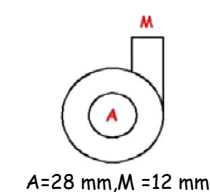

1103212 POMPA 0,15

KW 230V /

PUMP 0,15 KW 230V

FV20TFA, FV40TFA,

FV70TD, FV28GFA,

DV40TFA, DV80TFA:

MEIKO

0501166EX: MEIKO

9534806: MEIKO



1103737 ELETTROPO
MPA 0,15KW TIPO 2213
230V 50HZ /
PUMP 0,15KW TYPE
2213 230V 50HZ

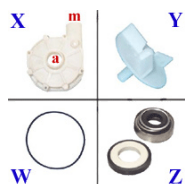

$a = 28\text{mm}, m = 28\text{mm},$
 $X=1103148, Y= 3109017,$
 $W=2104004, Z=3110026$

1103400 POMPA
T25K HP 0,25 /
PUMP T25K HP 0,25
6000: KRUPPS S.R.L.

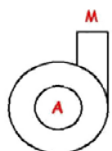

$A = 34\text{mm}, M = 33\text{mm}$

1103334 POMPA
KW0,19 DX 230V /
PUMP 0,19KW 230V
040F, S510, GS4, GS6:
LAMBER
GS501, GS502, GS515:
WINTERHALTER

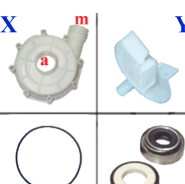

$a = 28\text{mm}, m = 27\text{mm},$
 $X=1103427, W=2101342,$
 $Z=3110027$

1103038 POMPA
ELETTROBAR 0,25 HP
230V 11/E41 T60 /
PUMP ELETTROBAR
11/E41 T60
11- E41,E42:
ELETTROBAR

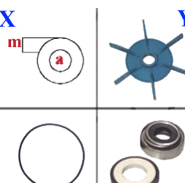
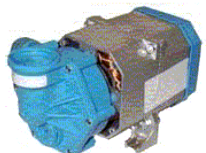

$a = 28\text{mm}, m = 40\text{mm},$
 $Y=3109103, W=2101428,$
 $Z= 3110027$

1103859 ELETTROPO
MPA 200W 230V-1PH-
50HZ CON
CONDENSATORE (4UF)
/
ELECTROPUMP 200W
230V-1PH-50HZ WITH
CAPACITOR (4UF)
80627: ELETTROBAR

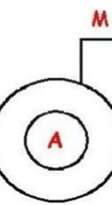

$M=28\text{mm}, A=28\text{mm}$

1103258 POMPA 0,30
HP 230V /
WATER PUMP 0,30HP
230V

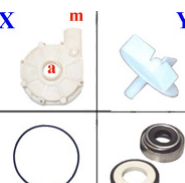

$a = 28\text{mm}, m = 28\text{mm},$
 $X=1103148, Y=3109034,$
 $W=2104004, Z=3110026$

1103300 POMPA
0,3HP ZF131DX /
ANTICLOCKWISE
PUMP 0,3HP ZF131
100802:

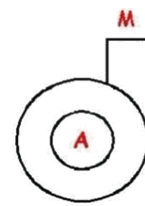

$= 1103663, = 3110077, A$
 $= 28\text{mm}, M = 27\text{mm}$

COMENDA ALI SPA
34013300NEW:
RANCILIO SPA
902235:
SILANOS SRL
35841:
HOONVED - ALI SPA

1103343 POMPA
0,30HP APERTA /
PUMP 0,22 KW
6989: A.T.A. SRL

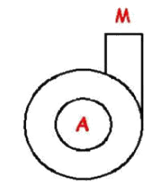

$M = 29\text{mm}, A = 28\text{mm},$
 $=3110026$

1103192 POMPA HP
0,33 230V 50HZ
10N/10FF /
PUMP 0,33HP 230V
50HZ 10N/10FF
C40F, DERBY CF,
STAR CF, TURBO CF,
TEKNO4 CF,;
DIHR-ALI SPA

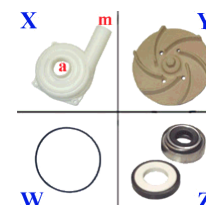

$a = 33\text{mm}, m = 30\text{mm},$
 $X=1103421, Y=3109096,$
 $W=2101346, Z=3110027$

1103193 POMPA HP
0,30 230V 2 VIE /
PUMP 2 WAYS 0,30HP
230V
CF40LS, STAR LS,
TURBO LS, TEKNO
LS: DIHR-ALI SPA
DW260050:
DIHR-ALI SPA

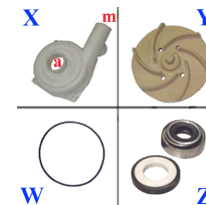

$a=33\text{mm}, m=30\text{mm},$
 $X=1103306, Y=3109096,$
 $W=2101346, Z=3110027$

1103292 POMPA +
TERMICO 230V 250W
T80 /
WATER PUMP 230V
250W T80
REB130116: COLGED
130116:
ELETTROBAR
DIVISIONE DELLA
EUROTEC SRL

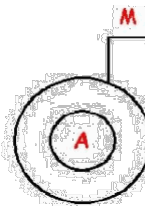

$hp = 0,35, A=32\text{mm},$
 $M=30\text{mm}$

1103195 POMPA HP
0,40 /
PUMP 0,40HP
LINEAR CF:
DIHR-ALI SPA

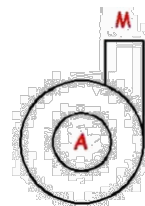

$hp 0,40, A = 29\text{mm},$
 $M=28\text{mm}$

1103631 POMPA
UNIVERBAR 0,4HP /
PUMP UNIVERBAR
0,4HP
4112:
UNIVER-BAR SRL

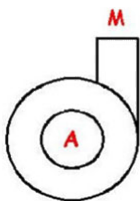

M=28mm, A=29mm,
=1103887

1103302 POMPA
RISCIACQUO 1P 230V /
PUMP 0,28KW 1HP
230V
LS6EA,LS10,LS12,LS1
4:

ELECTROLUX
LB1, LB2:
ELECTROLUX
GS202,GS215, GS302,
GS315:
WINTERHALTER
ITALIA SRL
3102561:
WINTERHALTER
ITALIA SRL



W Z
a= 28mm, m= 28mm,
X=1103621, Y=3109034,
W=2104004,Z=3110026

1103545 POMPA
220/240V 50 HZ /
PUMP 220/240V 50 HZ
OL0571:
ELECTROLUX
PROFESSIONAL
S.P.A.



a=32mm, m=30mm,
X=1103546, Y= 3109131,
W= 1103550,Z=3110027

1103704 "POMPA
RISCIACQUO; 50HZ;
KIT" 0,30HP /
DRAIN PUMP 50HZ
OL1640:
ELECTROLUX
PROFESSIONAL
S.P.A.



BODY=1103844

1103252 POMPA
230V T90 HP,045 /
PUMP OLYMPIA 230V
T90 HP,045
E45, E45-, 450-:
ELETTROBAR
DIVISIONE DELLA
EUROTEC SRL
BETA 240, SILVER
40: COLGED

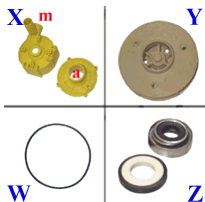
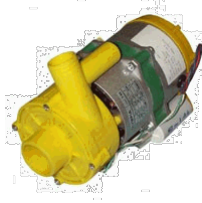

a=44mm, m=30mm,
X=1103426, Y=3109098,
W= 2101428,Z=3110027

1103468 POMPA
LAVAGGIO KRUPPS
6100 T45K 0,45 HP /
WASH PUMP KRUPPS
6100 T45K 0,45 HP
6100: KRUPPS S.R.L.

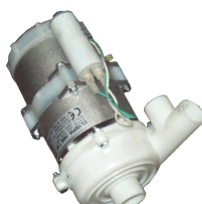

1103429 POMPA
HP0.45 230V2VIE
ORIE.37/40 /
PUMP 0,45 230V 2
WAYS ORIE.37/40
18300: DIHR-ALI SPA
DW18300:
DIHR-ALI SPA



a=33mm, m=30mm,
X=1103306, W=2101436,
Z=3110027



a=33mm, m=30mm,
X=1103306, Y=3109102,
W=2101436, Z=3110027

1103586 ELETTOPO
MPA 0,75 HP AM 5226
220-240/380 /
PUMP 0,75 HP AM 5226
220-240/380
*: MBM-
927022:
ELETTROBAR

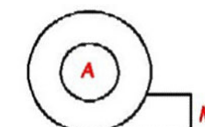

A=52mm, M=54mm

1103796 POMPA 0,60
KW 230/1/50
N45_N50_N90
ZF270VDX /
WASHING PUMP 0.60
KW 230/1/50
N45_N50_N90
ZF270VDX
902304:
SILANOS SRL

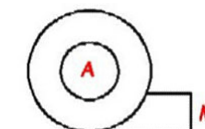

M=35mm, A=43mm

1103244 ELETTOPO
MPA HP1 230V 1/50HZ /
PUMP HP1 230V 1/50HZ
100925:
HOONVED - ALI SPA
ED550:
HOONVED - ALI SPA

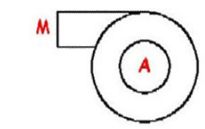

M = 53mm, A = 63mm,
=3109123, = 2104001

1103216 POMPA
0,73KW/230V WH /
PUMP 0,73 KW 230V
WH
GS8, GS14, GS14E,
GS15, GS15E, GS501:
WINTERHALTER
ITALIA SRL

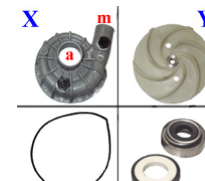

a=64 mm, m=54 mm,
X=1103443, Y=3109113,
W=2104021, Z=3110018

1103454 ELETTOPO
MPA 0,85KW 50Hz
C/COND. 230V /
PUMP 0,85KW 50Hz
WITH CAPACITOR

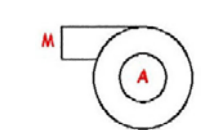
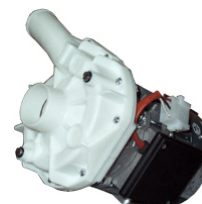

A= 50mm, M=40mm

1103875 ELETTROPO
MPA 1,5HP 230V 2241 /
WASHING PUMP 1,5HP
230V 2241
100719:
COMENDA ALI SPA

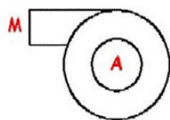

M= 53 mm, A= 63 mm

1103154 POMPA
1,5HP MONOFASE /
ONE-PHASE PUMP
1,5HP
S870:
ELETTOBAR
MS1300: MACH
S80, CS710, CS900,
CS950: COLGED

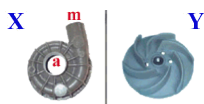

W a= 63 mm, m= 54 mm,
X=1103141, Y=3109031,
W= 2104001,Z=3110018

1103340 POMPA 1204
2HP 230V /
PUMP 1204 2HP 230V



W a= 63mm, m= 54mm,
X=1103141, Y= 3109026,
W= 2104001,Z=3110018

1103869 POMPA
1.2Hp 230/400V3N - TR
1200 ESX /
PUMP 1,2HP
230/400V3N TR1200
ESX
3427:
ARISTARCO SPA

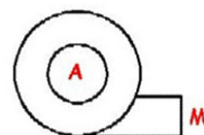

A= 62 mm, M= 54 mm

1103076 POMPA 1,2
HP 230/400V 50HZ 2241
/
PUMP 1,2HP 230/400V
50HZ 2241
C95:
COMENDA ALI SPA
1103076:
UNIVERSALE
DW3000082:
DIHR-ALI SPA
ED650E:
HOONVED - ALI SPA

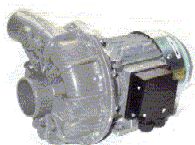

W a= 63mm, m= 54mm,
X=1103141, Y= 3109064,
W= 2104001,Z=3110018

1103077 POMPA 1,5
HP 230/400V 50HZ 1241
/
PUMP 1,5HP 230/400V
50HZ 1241
S870:
ELETTOBAR
DIVISIONE DELLA
EUROTEC SRL
LC380, LC400:
COMENDA ALI SPA
TR0060:

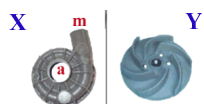

W a= 63mm, m= 54mm,
X=1103141, Y= 3109031,
W= 2104001,Z=3110018

SILANOS SRL
LS120:
RANCILIO SPA
S80, CS710, CS900,
CS50: COLGED
1103077:
UNIVERSALE
DV120, DV240:
MEIKO
MS1300: MACH
ED650S:
HOONVED - ALI SPA

1103674 POMPA.HP.1
.5.220/380V.50HZ /
PUMP
HP.1.5.220/380V.50HZ
100703:
COMENDA ALI SPA



W a= 63mm, m= 54mm,
X=1103141, Y= 3109031,
W= 2104001,Z=3110018

1103354 POMPA
COMENDA 100797 1,5
HP 380/3/50 /
PUMP COMENDA
100797 1.5 HP 380/3/50
100797:
COMENDA ALI SPA



A=60mm, M=54mm,
X=3109031, Y=2104001,
Z= 3110018

1103671 POMPA.HP.1
.5.220/380V.50HZ /
PUMP
HP.1.5.220/380V.50HZ
100663:
COMENDA ALI SPA



W a= 63mm, m= 54mm,
X=1103141, Y= 3109031,
W= 2104001,Z=3110018

1103225 POMPA 1,5
HP/1KW TRIF. /
THREEPHASE PUMP
1,5HP 1KW
3102411:
WINTERHALTER
ITALIA SRL
501463:
EURFRIGOR SRL
3102470:
WINTERHALTER
GS10, GS10/2, GS12,
GS22, GS32, GS40,
GS41, GS41/3:
WINTERHALTER
ITALIA SRL
GS41/4, GS41/5,
GS42, GS502, GS515:
WINTERHALTER
ITALIA SRL

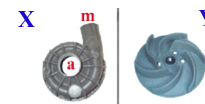

W a= 63mm, m= 54mm,
X=1103141, Y= 3109031,
W= 2104001,Z=3110018

1103083 POMPA 2 HP
220/380V 50HZ 1204 /
PUMP 2HP 220/380V
50HZ 1204

C155, C165, C166:
COMENDA ALI SPA
100380:
COMENDA ALI SPA
DPE312: COLGED
1103083:
UNIVERSALE
3102267:
WINTERHALTER
ITALIA SRL



$a = 63\text{mm}$, $m = 54\text{mm}$,
X=1103141, Y= 3109026,
W= 2104001,Z=3110018

1103677 POMPA.HP.2
.220/380V.50HZ /
PUMP
HP.2.220/380V.50HZ

100361:
COMENDA ALI SPA
100361:
HOONVED - ALI SPA

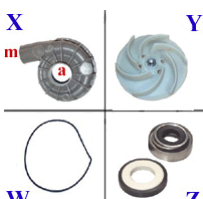

$a = 63\text{mm}$, $m = 54\text{mm}$,
X=1103141, Y= 3109026,
W= 2104001,Z=3110018

1103498 POMPA HP 2
-220/380V-50HZ1204 /
PUMP HP 2 -220/380V-
50HZ1204

100693:
COMENDA ALI SPA



$a = 63\text{mm}$, $m = 54\text{mm}$,
X=1103141, Y= 3109026,
W= 2104001,Z=3110018

1103676 POMPA HP
1,5 KW 1,1 230V/1-380V
5223.2350 /
WASHING PUMP 1.5 HP
1.1 KW 230V/1-380V
5223.2350

100801:
COMENDA ALI SPA

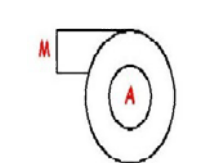

A=60mm,M=51mm

1103697 POMPA
1,4KW 230/400V /
PUMP 1,4KW 230/400V
247.90.0572: JEMI



$a = 63\text{mm}$, $m = 54\text{mm}$,
X=1103443, Y=3109026,
W= 2104001,Z=3110018

1103491 POMPA HP 2
380/3/50 5234.4055 /
PUMP HP 2 380/3/50
5234.4055

100795:
COMENDA ALI SPA

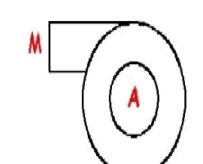

A=60mm, M=60mm

1103517 ELETTR.HP2
.2 DX 230/400V3 50HZ /
PUMP HP2,2 230/400V
50HZ

H34432:
COMENDA ALI SPA
34432:
HOONVED - ALI SPA

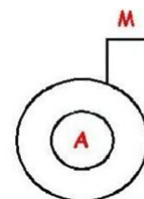

A=60mm, M=60mm

1103753 POMPA HP
2,2 230/400-3 50HZ /
PUMP HP 2,2 230/400-3
50HZ

36334:
HOONVED - ALI SPA
H36334:
COMENDA ALI SPA

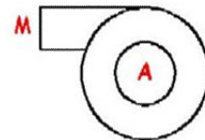

A=60mm,M=52mm

1103701 POMPA
WINTERHALTER
1,8KW /
PUMP WINTERHALTER
1,8KW

3102392:
WINTERHALTER
3102573:
WINTERHALTER
ITALIA SRL

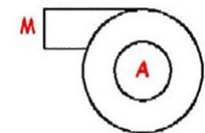

A=60mm, M=53mm,
seal= 3110018,
body=1103443

1103090 POMPA 2,7
HP 220/380V 50HZ
TRIFASE /
THREE-PHASE PUMP
2,7HP 220/380V 50HZ

CS1300: COLGED
100373:
COMENDA ALI SPA
1103090:
UNIVERSALE

DW88106E:
DIHR-ALI SPA
DV120,FV120D,
FV130D, FV240B,
DV260B: MEIKO
DW88107: DIHR-ALI
GS63:

WINTERHALTER
GS63:
WINTERHALTER
GS63:
WINTERHALTER

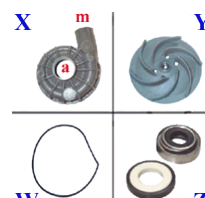

$a = 63\text{mm}$, $m = 54\text{mm}$,
X=1103141, Y= 3109027,
W= 2104001,Z=3110018

1103668 POMPA 2
KW 400/3/50 DX
LPN109/T /
PUMP 2KW 400/3/50 DX
LPN109/T

TR0080: SILANOS
SRL
32M4830: ANGELO
PO

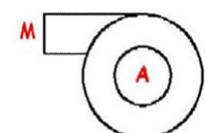

A=63mm,M=54mm

1103088 POMPA 3 HP
220/380V 50HZ
TRIFASE /
THREE-PHASE PUMP
3HP 220/380V 50HZ
100666: **COMENDA**
ALI
130005: **ELETTROBAR**
100387: **COMENDA**
MLP70,MLP80,
MLP140: **MACH**
1103088:
UNIVERSALE
25334: **HOONVED**
35559: **HOONVED**
DW88106: **DIHR-ALI**

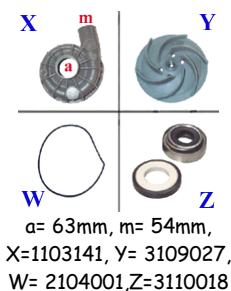

a= 63mm, m=54mm,
X=1103141, Y= 3109027,
W= 2104001,Z=3110018

1103673 POMPA HP 3
220-415-50 HZ 1205 /
PUMP HP 3 220-415-50
HZ 1205
100674:
COMENDA ALI SPA
100674:
HOONVED - ALI SPA



1103738 "POMPA
LAVAGGIO; 3-P 1760W
50HZ" /
"WASH PUMP; 3-P
1760W 50HZ"
048094: **ELECTROLUX**



1103087 POMPA 0,10
HP 230V 50HZ
MONOFASE /
ONE-PHASE PUMP
0,10HP 230V 50HZ
B10, B12: **COMENDA**
B20:**COMENDA**
1103087:
UNIVERSALE
COMPACT,CF235:
ADLER S.P.A.
DW10501A**: **DIHR**
0300252: **LAMBER**

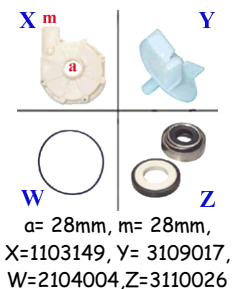

1103115 POMPA
3,5HP TRIFASE
240/415V /
THREE-PHASE PUMP
3,5HP 240/415V
OPRY49: **ELECTROLUX**
100713: **COMENDA**
100704: **COMENDA**
100679: **COMENDA**

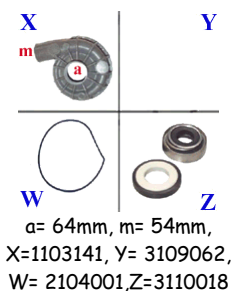

1103042 POMPA
0,15HP SX COMENDA /
CLOCKWISE PUMP
0,15HP COMENDA
EP152214M:
OMNIWASH SRL
35-: **ELETTROBAR**
1103042:**COMENDA**
350-: **ELETTROBAR**
AL16: **A.T.A. SRL**
AL03: **A.T.A. SRL**
1103042:**UNIVERSAL**
E
BD11: **ELFRAMO SPA**



1103829 POMPA
LAVAGGIO HP3 380V /
WASHING PUMP HP3
380V



1103351 POMPA
LAVAGGIO 0,15HPSX
ATA /
ANTICLOCKWISE
WASH PUMP 0,15HP
ATA
AL03, AL16:
A.T.A. SRL
8204: **A.T.A. SRL**

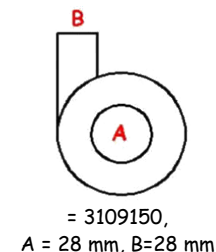

1103826 POMPA
LAVAGGIO UX/UXL
2,88KW/3,84 HP/
WASH PUMP UX/UXL
7854401:
HOBART GmbH

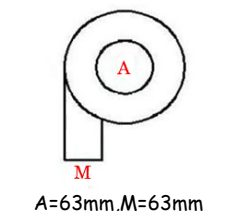

1103033 POMPA HP
0,20 SILANOS SX /
CLOCKWISE PUMP
0,20HP SILANOS
35-,350-
:ELETTROBAR
SVEL TINA,024,030,R
20,R20A,R23A,R36:
SILANOS SRL
MB235LI,MB240LI:
MACH
35: **COLGED**
040PF,S510,G54,G56:
LAMBER
20160025*:
ELFRAMO SPA



1103718 POMPA 4HP
230/400V3/50 VERS.2 /
PUMP 4HP 230/400V3/50
100901:
COMENDA ALI SPA



1103017 POMPA
HP0,20 220/240 2228 /
PUMP 0,20HP 2207240
2228

LBR-,LBC219:
COMENDA ALI SPA
B15-19,B10T-12T,;
COMENDA ALI SPA



1103333 POMPA
KW0,19 SX 230V /
PUMP 0,19KW 230V
MB235LI, MB240LI:
MACH
8000: KRUPPS S.R.L.
DERBY,DERBY40,GS3
5,GS37,; DIHR-ALI
SPA



1103005 POMPA
HP025 LT11/110 /
PUMP 0,25HP LT11/110
LT100,110,L T11:
RANCILIO SPA
GEMINICF-
CR,PASSPORT38.25-
40.48,PROGRAM25CF-
CR,ALISEO422-428:
ARISTARCO SPA
1103005:
S.V. ITALIA SRL
1103005:
UNIVERSALE
CB20N,
CB21N:COLGED



1103049 POMPA
0,25HP 220-240V 50HZ /
PUMP 0,25HP 220-240V
50HZ
984105000:
GRUPPO CIMBALI
SPA
*****: RANCILIO SPA
902220: SILANOS
SRL
1103049: CIMBALI
1103049:
UNIVERSALE
RB43,RS43,RSD43,P4
3, P43B, P43E,
NP43,P48A,P48E,NP48
,NPD48,;
GRUPPO CIMBALI
SPA
23131: HOONVED

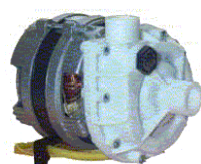

1103156 POMPA 0,25
HP ADLER /
PUMP 0,25HP ADLER
CF35: ADLER S.P.A.

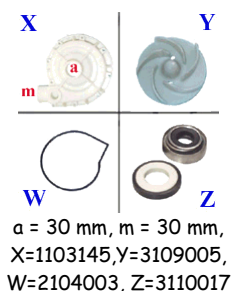

1103316 POMPA 0,25
1267A /
PUMP 0,25 1267A
B101,B203,DS11,DS13,
DS101,DS103:
ADLER S.P.A.



1103259 POMPA 0,25
HP 230V /
PUMP 0,25HP 230V



1103813 ELETTROPO
MPA SCAR.LAV.50-
60HZ 230V 0,27 HP/
DRAIN PUMP
WASHING DISHES 50-
60HZ 230V
*: ELFRAMO SPA

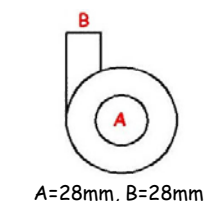

1103063 POMPA
LAV. 0.3HP COMENDA
/
WASH PUMP 0,3HP
COMENDA
B13T/TM-19TMM,BC-
BR,LBC15/275,FC43:
COMENDA ALI SPA
C35,C43,C48,CR43,CR
48:
HOONVED - ALI SPA
BD13,BD14,BD15:
ELFRAMO SPA

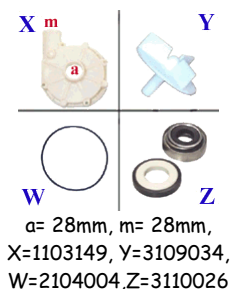

1103180 POMPA
0,3HP 220/240 ZF170SX /
PUMP 0,3HP 220/240
XBHC
00202481:
ELFRAMO SPA
BHC:
COMENDA ALI SPA

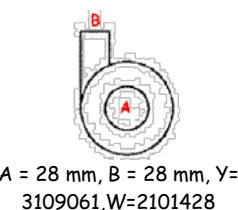

1103020 ELETTROPO

MPA 0,3 HP 230V /
PUMP 0,3HP 230V

JOLLI, UNO, ELITEJ3
50-360, ELITEN350-
NA36:

OMNIWASH SRL -
18010064:

NUOVA SIMONELLI
SPA



0,3hp, A=32mm, M=32mm,
X=1103357, Y=3109079,
W=2102139, Z=3110018

W=2104002, Z=3110027

1103294 POMPA

0,30HP 230V /
PUMP 0,30HP 230V

40259: ADLER S.P.A.
CF11, CF103, DSF11, DSF
103, CF40, DL240:

ADLER S.P.A.



a= 30mm, m= 31mm,
X=1103145, Y=3109032,
W=2104003, Z= 3110017

1103301 POMPA

0,3HP 230V/50HZ HNVD
/
PUMP 0,3HP 230V/50HZ
HNVD

31260:

HOONVED - ALI SPA



a= 45mm, m= 30mm,
X=1103447, Y=3109032,
W= 2104003, Z=3110017

1103123 ELETTROPO

MPA HP 0,3 TIPO 0226 /
PUMP 0,3HP TYPE 0226

C43ALTA, C48D

DL, STS43, STS43D,
STS48 OLD, STS48D:

HOONVED - ALI SPA



a=33mm, m=30mm,
X=1103336, Y=3109093,
W= 2101346, Z=3110026

1103194 POMPA HP

0,3 1"X28 220V 50HZ /
"PUMP HP 0,31"X28
220V 50HZ"

WD1350: WEGA SRL

GS40: DIHR-ALI SPA



a = 39 mm, m = 27 mm,
X=1103424, Y=3109099,
W=2101342, Z=3110027

1103155 POMPA 0,33

HP HOONVED /
PUMP 0,33HP
HOONVED

28850: HOONVED -
ALI SPA



a = 45 mm, m = 41 mm, X=
1103146, Y=3109020,

1103257 POMPA

0,33HP 230V /
WATER PUMP 0,33HP
230V

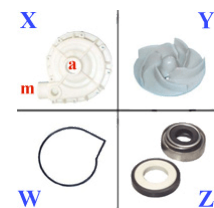

a= 32mm, b= 30mm,
X=1103145, Y=3109032,
W= 2104003, Z=3110017

1103245 POMPA

HP0,33 ZF171 /
PUMP 0,33HP ZF171

C35, C43, C48, CR43,
CR48:

HOONVED - ALI SPA

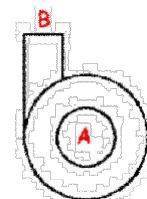

Kw 0,20 230V, A=27mm,
M= 27mm, =3109162

1103034 ELETTROPO

MPA LAV. 42E 50HZ
ELF 0,25KW /

PUMP 42E 50HZ

ELFRAMO

908880: SILANOS

SRL

BD11-B15:

ELFRAMO SPA

35: COLGED

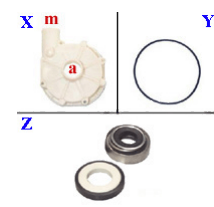

a=27mm, m=26mm,
X=1103281, Y=2104004,
Z= 3110026

1103214 POMPA 0,25

KW/230V WH /

PUMP 0,25 KW 230V

WH

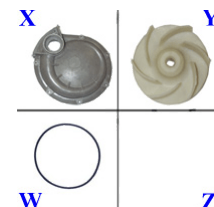

X= 1103441, Y=3109112,
W=2104024

1103289 Z401001000

ELETTROPOMPA LAV.

FA15 2-102 /

PUMP FA15 2-102

Z401001000EX:

FAGOR

12023429: FAGOR

20160040:

ELFRAMO SPA

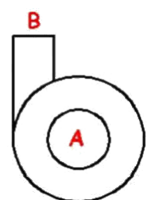

A = 38mm, B = 39mm,
0,26KW

1103032 POMPA PER

AL 20 ATA 7675 /

PUMP ATA AL 20 7675

8207: A.T.A. SRL

AL20/25,26,AL40,AL4

5: A.T.A. SRL

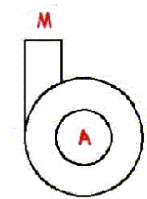

0,40 hp, X= 3109092,
A= 45mm, B= 40mm, 230V

1103051 ELETTROPO
MPA 300W ELFRAMO /
PUMP 300W ELFRAMO
1103051: **KOMEL**
SQ42, SQ48:
ELFRAMO SPA

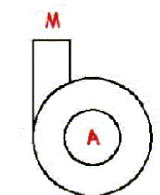

300w, A= 50mm,
M=45mm, 230v

1103319 POMPA
HP0,4 T30 220/240V /
PUMP 0,4HP T30
220/240V

S634, S636,21-, 25-,
30-, 31-:

ELETTROBAR

S621, S623, S624,
S626, S631, S633:

ELETTROBAR

42: **COLGED**

LTB11, LTB12,LTB22:

ELECTROLUX.

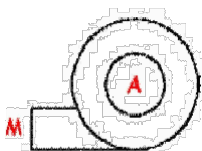

= 1103378, A=45 mm,
M=31 mm

1103181 POMPA 0,36
KW LGB COMENDA /
PUMP 0,3HP LGB
COMENDA

BHC FROM 9401-801:

COMENDA ALI SPA

NK43, E36, E40, E43,

CM43: **HOONVED**

C48, C43, C46:

HOONVED - ALI SPA



a=30mm, m=30mm,
X=1103478, Y=3109048,
W= 2101348,Z=3110017

1103532 POMPA HP
0,50 V230 MAGG.
X40.28 /
PUMP HP 0,50 V230
MAGG. X40.28

3259:

ARISTARCO SPA

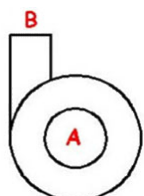

A=45mm, B=40mm

1103041 POMPA
0,5HP 1288 SX SILANOS

CLOCKWISE PUMP
0,50HP 1288 SILANOS

R29,F27A,E40,V40,25

0: **SILANOS SRL**

902261:

SILANOS SRL



a= 30mm, m= 30mm,
X=1103145, Y=3109032,
W=2104003,Z= 3110017

1103050 POMPA
05HP 220-240V 50HZ /
PUMP 05HP 220-240V
50HZ

1103050:**UNIVERSAL**

E

SF3,SF4: **CIMBALI**

FS70, FS71,: **FAEMA**

SP43, SP48, RS48,

RS48



a= 30mm, m= 30mm,
X=1103145, Y=3109032,
W=2104003,Z=3110017,

GRUPPO CIMBALI
SPA
25313:**HOONVED**

FITTING=1125157

1103004 POMPA
050HP LT 22/285 /
PUMP 0,50HP LT22
PROJET28E,GL4.32:
PASSPORT45.30,
PASSPORT50.35:

ARISTARCO SPA

LT20,LT22,LT200,LT2

20,LT300,LT320,

LT285,LT295:

RANCILIO SPA

*: **S.V. ITALIA SRL**

1103004:

UNIVERSALE



a= 45mm, m= 40mm,
X=1103143, Y=3109033,
W=2104002,Z=3110027

1103280 POMPA HP
0,5 230V /
WATER PUMP HP 0,5
230V

GS24:

WINTERHALTER

ITALIA SRL



a= 45mm, m= 41mm,
X=1103446, Y=3109033,
W=2104002,Z=3110027

1103264 POMPA HP
0,5 220V /
WATER PUMP HP 0,5
220V



a= 41mm, m= 45mm,
X=1103143, Y=3109033,
W=2104002,Z=3110027

1103298 POMPA
HP0,5 230V /
PUMP 0,5HP 230V
100696:

COMENDA ALI SPA

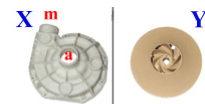

a= 37mm, m= 40mm,
X=1103287, Y=3109039,
W=2104002,Z=3110027

1103634 ELETTRM
POMPA 0,5 HP 230V
1272A /
PUMP 0,5HP 230V
1272A



A=28mm, M=28mm,
X=1103145, Y= 3109166,
W= 2104003,Z=3110017

1103341 POMPA
0,50HP 230V /
PUMP 0,50HP 230V

B40,B41: ADLER S.P.A.



a= 36mm, m= 40mm,
X=1103143, Y=3109060,
W=2104002,Z=3110027

1103886 ELETTROPO
MPA 0,37KW 230V 3910
/
ELECTROPUMP 0.37
KW 230V 3910

012407831:

HOBART GmbH

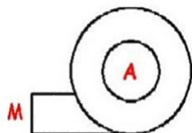

A=45mm ,M=40mm,
HP 0,50

1103902 ELETTROPO
MPA 0,37 KW 230V
5283.1425 /
ELECTROPUMP 0,37
KW 230V 5283.1425

2011002: JEMI

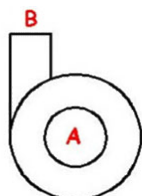

A=45mm,M=40mm

1103208 POMPA
0,5HP 220V COMENDA
/
PUMP COMENDA
0,50HP 220V 100346

100346:

COMENDA ALI SPA

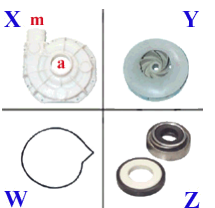

a= 45mm, m= 42mm,
X=1103409, Y=3109033,
W=2104002,Z=3110027

1103228 POMPA
0,5HP USCITA
ORIZZONTALE /
PUMP 0,5HP

AL40, AL45:

A.T.A. SRL

AL30, AL35:

A.T.A. SRL

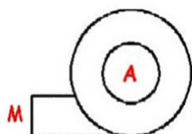

A=44mm,M=41mm,
=3109092

1103305 POMPA HP
0,5 230V UNVB /
PUMP 0,5HP 230V
UNVB

3730:

UNIVER-BAR SRL

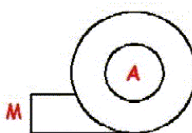

hp 0,5,
A=50 mm, B=40 mm

1103196 POMPA HP
0,5 ASP. D.50 230V
50HZ /
PUMP 0,5HP D.50 230V
50HZ

LINEAR LS:

DIHR-ALI SPA

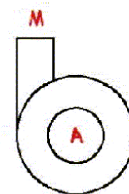

A=50 mm,B=31 mm, hp
0,50, fan= 3109056, seal=
3110018, gasket=2102254

1103845 ELETTROPO
MPA 0,4KW 230V 50HZ
FIR /
ELECTROPUMP 0.4 KW
230V 50HZ FIR

902263:

SILANOS SRL

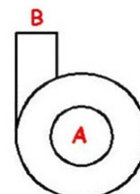

hp = 0,50,
A= 44 mm,M = 39 mm

1103730 ELETTRP.
ASH170 SX 0,4 Kw
230V150Hz /
PUMP ASH170 SX
230V150Hz

38791:

HOONVED - ALI SPA

37820:

HOONVED - ALI SPA

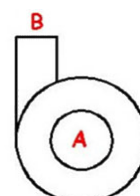

M= 36mm, A= 45mm

1103794 ELETTROPO
MPA .ASH175 H60
230V150Hz /
WASHING PUMP.
ASH175 H60 230V150Hz

38792:

HOONVED - ALI SPA

38039:

HOONVED - ALI SPA

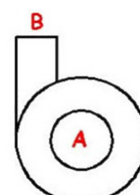

M=34mm, =3109211,
A=44mm

1103197 POMPA HP
0,6 230V 50HZ /
PUMP 0,6HP 230V 50HZ

GASTRO 450:

DIHR-ALI SPA

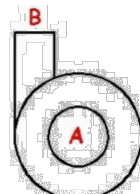

= 2102254,
A =50mm ,B= 31mm

1103012 POMPA
HP0,6 COMENDA /
PUMP 0,6HP COMENDA
AL. 15

F2,F3,F55,F65:

COMENDA ALI SPA

FC-,LF280-323,R70,

LF28-323:

COMENDA ALI SPA

1F,F85,F92,L20,L21:

LAMBER

045F,050F075F:

LAMBER

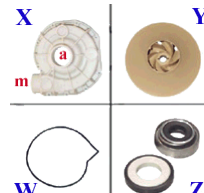

a= 38mm, m= 40mm,
X=1103287,Y=3109059,
W=2104002,Z=3110018,
braket=4115513

1103021 ELETTROPO
MPA 0,6HP 230V /
PUMP 0,6HP 230V
ELITEJ400-
410,ELITENA400-
410,DUE:
OMNIWASH SRL -
SOCIETA' A SOCIO
UNICO



1103516 POMPA HP
0,6 LGB ZF350 220V /
PUMP HP 0.6 LGB
ZF350 220V
100820:
COMENDA ALI SPA

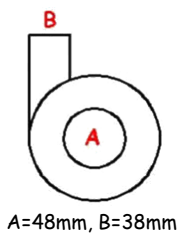

1103053 ELETTROPO
MPA 500W ELFRAMO /
PUMP 500W ELFRAMO
1103053: KOMEL
SQ55, SQ60, D30,
D40: ELFRAMO SPA
20160062:
ELFRAMO SPA

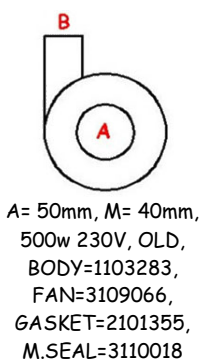

1103520 MOTORE
POMPA LAVAGGIO HP
0,7 /
PUMP HP 0,7
6300: KRUPPS S.R.L.

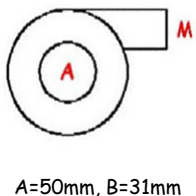

1103198 POMPA HP
0,7 TIPO 50 230V 50HZ
CON F /
PUMP 0,7HP TYPE 50
230V 50HZ
6S45, 6S50:
DIHR-ALI SPA

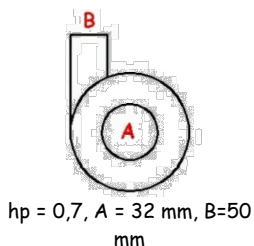

1103199 POMPA
0,75HP 230V 50HZ
OLYMPIA /
PUMP OLYMPIA 0,75HP
230V 50HZ
6S500-900:
DIHR-ALI SPA

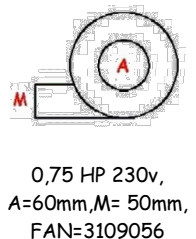

1103519 MOTORE
POMPA LAVAGGIO HP
0,75 /
PUMP HP 0,75
6400: KRUPPS S.R.L.

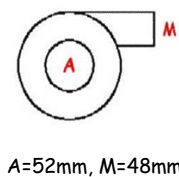

1103173 POMPA 0,75
DIHR 2233X1 /
PUMP 0,75 DIHR
2233X1
6600: DIHR-ALI SPA



1103200 POMPA
0,75HP 220/240V 50HZ
FIR 2233/X1 /
PUMP 0,75HP 220/240V
50HZ FIR 2233/X1
TEKNO 6:
DIHR-ALI SPA

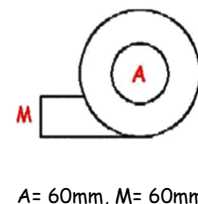

1103085 POMPA 0,75
HP 220 50HZ
MONOFASE /
ONE-PHASE PUMP
0,75HP 220V 50HZ
45: ARISTARCO SPA
1103085:
UNIVERSALE



1103267 ELETTROPO
MPA HP 0,75 /
WATER PUMP HP 0,37



1103084 POMPA 0,75
HP 220V 50HZ
MONOFASE /
ONE-PHASE PUMP
0,75HP 220V 50HZ
1103084:
UNIVERSALE



1103086 POMPA
0,75HP 230V/50HZ
MONOFASE /
ONE-PHASE PUMP
0,75HP 230V 50HZ
M52/60,
E50,NK52/60, T5/80,
UNI53R:
HOONVED - ALI SPA
1103086:
UNIVERSALE



1103164 POMPA
0,75HP 230/1/50 6-7-8-
1000 D. 90 LGB /
PUMP 0,75HP 230/1/50
6-7-8-1000 D.90
E45: SILANOS SRL
E45: SILANOS SRL

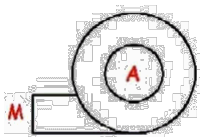

1103324 POMPA
0,75HP 230V /
PUMP 0,75HP 230V
CF50,DS600:
ADLER S.P.A.



1103876 ELETTROPO
MPA 0,55KW 230V 50HZ
2265.1920 /
ELECTRIC PUMP FIR
2265 SX 0.75HP
40224: ADLER S.P.A.

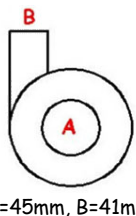

1103078 POMPA 0,75
HP 230V 50HZ 3911/A /
PUMP 0,75HP 230V
50HZ 3911/A
LT365, LT375:
RANCILIO SPA
LS66, LS60:
RANCILIO SPA
MLS35-3 MLS35:
MARENO
FR30G,FR40G, FV20,
FV110,DV40,
ECOSTAR430F,ECOS
TAR530F: MEIKO
MS350: MACH
1103078:
UNIVERSALE
SF6: CIMBALI
FS80: FAEMA
LS3, LS3-1, LS4,LS30,
LS31,LS35: LASA SRL
C53, C60, CR5,
STS53,STS60:
HOONVED - ALI SPA

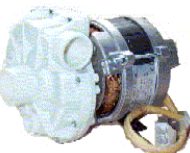

RS53, RSD53,SP60:
GRUPPO CIMBALI
SPA
EA003: OEM ALI SPA
GS25, GS27, GS27R,
GS28:
WINTERHALTER
ITALIA SRL
977066000:
GRUPPO CIMBALI
SPA

1103210 POMPA
0,75HP 220V COMENDA
/
PUMP COMENDA
0,75HP 220V
F3:
COMENDA ALI SPA



1103476 ELETTROPO
MPA 1217/A 0,75HP
230V /
PUMP 1217/A 0,75HP
230V

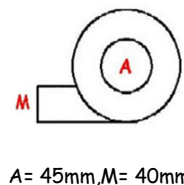

1103215 POMPA
0,55KW 230V WH /
PUMP 0,55 KW 230V
WH
512055500:
MARENO INDUSTRIE
ALI SPA
GS29, GS29B:
WINTERHALTER
ITALIA SRL

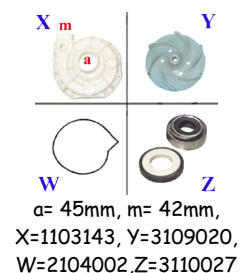

1103217 POMPA
0,55KW 230V HB /
PUMP 0,55 KW 230V HB

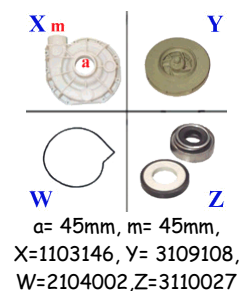

1103406 POMPA 0,50
KW 230/1/50 /N45 V.T. /
PUMP 0,50 KW 230/1/50
/N45 V.T.
902294:
SILANOS SRL

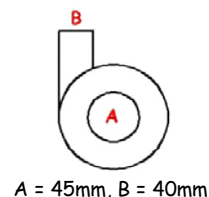

1103295 POMPA HP
0,75 220V 50HZ /
PUMP 0,75HP 220V
50HZ

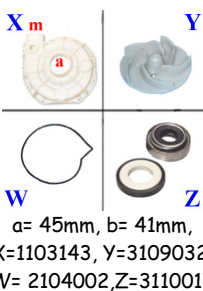

1103260 POMPA 0,75
HP 230V /
WATER PUMP 0,75HP
230V
100363:
COMENDA ALI SPA



1103233 POMPA
0,75HP APERTA 230V /
PUMP 0,75HP
AF61, AF78:
A.T.A. SRL

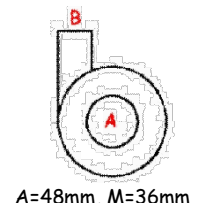

1103098 POMPA 0,75
HP APERTA ATA /
OPENED PUMP 0,75HP
ATA 4683
AL50, AL60, AF73,
AF78: A.T.A. SRL

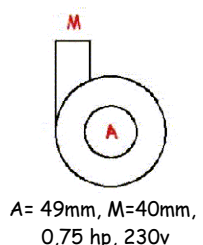

1103344 POMPA
0,75HP COMPLETA DI
STAFFA /
PUMP 0,75HP
8203: A.T.A. SRL
AAL54,AL55:
A.T.A. SRL

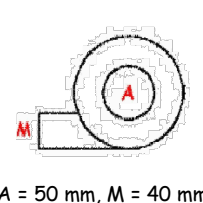

1103282 POMPA
0,75HP /
WATER PUMP 0,75HP
902293:
SILANOS SRL
C60E:
HOONVED - ALI SPA



1103223 POMPA 0,75
A500-DS400 /
PUMP 0,75HP A500-
DS400
40010: ADLER S.P.A.
B301, B303, B303F,
DS400, DS412:
ADLER S.P.A.



1103249 POMPA DI
LAVAGGIO X MOD.
S100 ZF210SX 0,75 HP /
WASH PUMP X MOD.
S100
50650:
SISTEMA PROJECT
SERVICE SRL

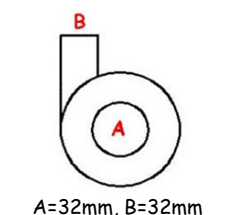

1103080 POMPA 0,75
HP 220V 1293 /
PUMP 0,75HP 220V 1293
841151: TEIKOS SRL
1103080:
UNIVERSALE
MS450, MS450E:
MACH



1103377 POMPA HP
0,75 230V /
PUMP HP 0,75 230V

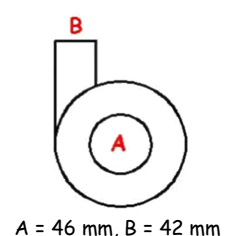

1103401 POMPA
0,75HP 230V /
PUMP 0,75HP 230V
3350:
UNIVER-BAR SRL

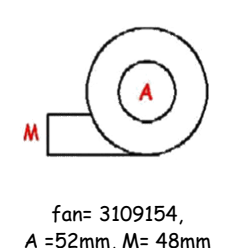

1103664 ELETTRICO
MPA 1217.2702 0,75HP
230V /
ELECTRIC PUMP
1217.2702 0.75 HP 230V

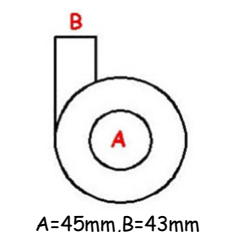

1103793 POMPA
MONOFASE 0,60KW /
WASH PUMP 220V /
0,60 KW
8201: A.T.A. SRL

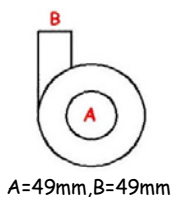

A=49mm, B=49mm

1103125 POMPA 0,80
HP 220-240V
ELETTOBAR /
PUMP 0,80HP 220-240V
ELETTOBAR
926078:

ELETTOBAR
T173:

ELETTOBAR
T175:

ELETTOBAR
E46,46-

460,50F,050FP:

ELETTOBAR

F85, F85P,50-, 500-,

E50: ELETTOBAR

*: MBM- EUROTEC

SRL

DPE219: COLGED

BETA246,

BETA250,B46,B50,

B59S, B53: COLGED

D130109:

GIGA GRANDI

CUCINE SRL

80112: MBM-

EUROTEC



a = 50mm, m= 50mm,
X=1103152, Y=3109036,
W= 2104005, Z=3110018

1103511 ELETTOPO
MPA 0,8HP 220/240V
50Hz B237T2251 /
PUMP 0,8HP 220/240V
50Hz B237T2251



a= 50mm, m= 50mm,
X=1103152, Y=3109036,
W= 2104005, Z=3110018

1103486 ELETTRM
POMPA 0,59KW 240V
FAGOR 10 MF /
PUMP 0,59KW 240V
FAGOR

12024265: FAGOR

FI80: FAGOR

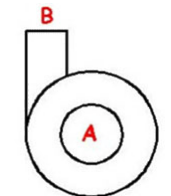

A=38mm, B=39mm

1103527 ELETTOPO
MPA LAV. FA30 2-123
230V /
PUMP FA30 2-123 230V
20160042:

ELFRAMO SPA

12024265*:

FAGOR

INDUSTRIALE S.R.L.

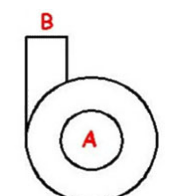

A=38mm, M=39mm

1103797 ELETTOPO
MPA KW0,60 50HZ
MON 230V /
ELECTRO-WASHING
PUMP KW0, 60 50HZ
230V

D85: ELFRAMO SPA

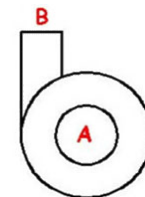

A=52mm, M=42mm

1103272 ELETTOPO
MPA KW0,7 T70 /
PUMP 0,7KW T70

130074:

ELETTOBAR
DIVISIONE DELLA
EUROTEC SRL

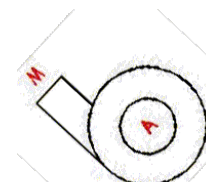

kw 0,7,
A=49 mm, M=49 mm

1103299 POMPA
KW0,74/HP1-220/240
DIHR /
PUMP 0,74KW/1HP
220/240 DIHR

DW159080:

DIHR-ALI SPA

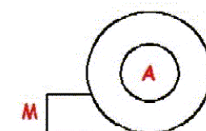

hp 1, A=60 mm, M=50mm

1103211 POMPA 0,73
KW 230V /
PUMP 0,73 KW 230V

DV80, DV160: MEIKO

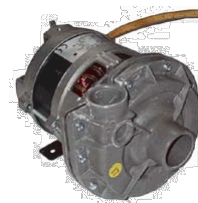

a=45mm, m=42mm,
X=1103439, Y=3109109,
W=2104022, Z=3110027

1103201 POMPA
0,74KW 220-240V 50HZ
/
PUMP 0,74KW 220-240V
50HZ

G600: DIHR-ALI SPA



a = 60 mm, m = 50 mm,
X=1103438, Y=3109087,
W=2104005, Z=3110018

1103277 POMPA
MONOFASE 0,73KW
220V /
WATER PUMP 1PHASE
0,73KW 220V

E60, CLEAN100, E100:

ELETTOBAR
DIVISIONE DELLA
EUROTEC SRL

S58, S585, 61: COLGED

DPE210: COLGED



a = 60mm, m= 50mm,
X=1103445, Y= 3109115,
W= 2104005, Z=3110018

1103303 POMPA
KW0736 220.240 /
PUMP 0736KW 220.240
LS5,LS6:
ELECTROLUX
PROFESSIONAL
S.P.A.

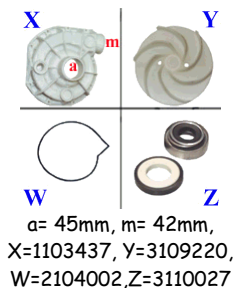

1103070 POMPA 1 HP
230/50 E-V-C SILANOS /
PUMP 1HP 230/50 E-V-C
SILANOS
E-V-C: SILANOS SRL
E-V-C: SILANOS SRL



1103071 POMPA
LAVAGGIO 220/240V
048664 1HP /
WASH PUMP 220/240V
048885
048664:
ELECTROLUX
PROFESSIONAL
S.P.A.

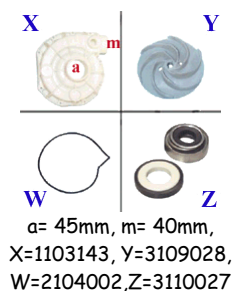
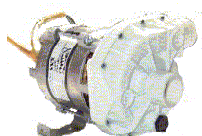

1103380 ELETTOPO
MPA 1H 220/5 2236
CLASSE ISOLAM /
PUMP 1H 220/5 2236
*:
MBM- EUROTEC SRL -
DIV. COOKING
SERVICE
DPE236:
ELETTOBAR

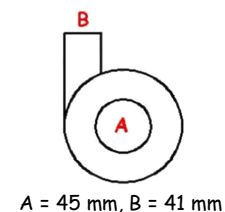

1103884 ELETTOPO
MPA HP. 1 230V /
ELECTROPUMP HP. 1
230V
34170FIR:
HOONVED - ALI SPA

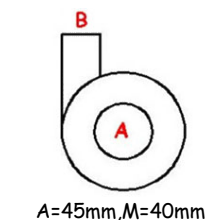

1103883 POMPA 1HP
230V 50Hz /
WASHING PUMP 1HP
230V 50Hz
2868:
ARISTARCO SPA

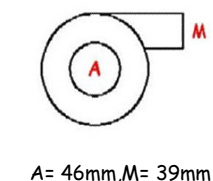

1103404 ELETTOPO
MPA HP. 1 STS/C60 /
PUMP 1HP STS/C60
100819:
COMENDA ALI SPA
C60E:
HOONVED - ALI SPA

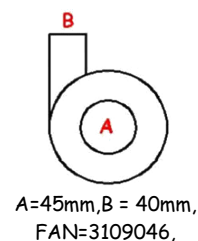

1103475 ELETTOPO
MPA HP. 1 C 68 E /
PUMP HP. 1 C 68 E
C68E:
HOONVED - ALI SPA

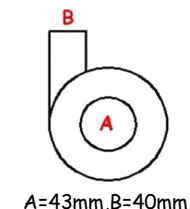

1103045 POMPA
230V M. HP1 CHIUSA /
CLOSED PUMP 1HP
230V RANCILIO
C75,LF450, F45-
80,C85,LF450A:
COMENDA ALI SPA
F80,C30,C70:
COMENDA ALI SPA
LS605,LS665:
RANCILIO SPA

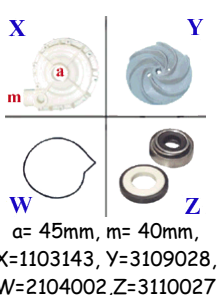

1103410 POMPA 1HP
230V 50Hz 1219 /
PUMP 1HP 230V 50Hz
1219



1103182 POMPA 1 HP
LGB COMENDA /
PUMP 1 HP LGB
COMENDA
C60E:
HOONVED - ALI SPA
LF350:
COMENDA ALI SPA

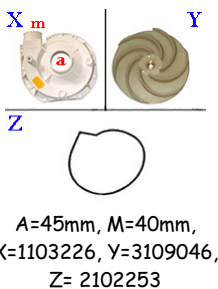

1103183 POMPA 1 HP
220/240 LGB
COMENDA / PUMP 1
HP 220/240 LGB
COMENDA
LP360:
COMENDA ALI SPA



1103815 "POMPA
LAVAGGIO; 230V 1HP
50HZ" /
"WASHING PUMP; 1P
230V 50HZ"
OL0126:
ELECTROLUX

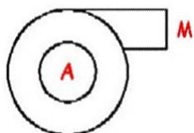

A=45mm, M=38mm

1103696 POMPA 1HP
230V 2233 /
PUMP 1HP 230V 2233
247.90.0524: JEMI



a=60mm, m=50mm,
X=1103445, Y=3109081,
W= 2104005, Z=3110018

1103055 POMPA 1 HP
IME CHIUSA/APERTA /
CLOSED/OPEN PUMP
1HP IME
ELITE4SA, SEI 2P:
OMNIWASH SRL -
SOCIETA' A SOCIO
UNICO

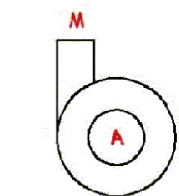

1 hp, 230v, A= 46mm,
M= 39mm

1103291 POMPA DI
LAVAGGIO 1HP 50HZ /
WATER PUMP 1HP
50HZ
LS360, LS365, LS510,
LS520, LS521:
ELECTROLUX
PROFESSIONAL
S.P.A.

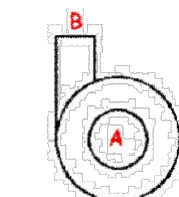

A = 45 mm, M = 42 mm

1103569 POMPA 1HP
230V 50HZ
MONOF.STATORE
55MM GL/7.40 /
PUMP 1HP 230V 50HZ
4053: ARISTARCO
SPA

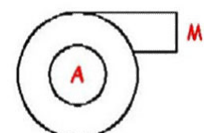

A=44mm, M=40mm

1103903 ELETTROPO
MPA 0,75KW 230V
4219C2350 /
ELECTROPUMP
0,75KW 230V 4219C2350
2011119: JEMI

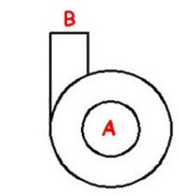

A=45mm, M=40mm

1103101 ELETTROPO
MPA kW0,80 MRS 230V
50HZ CAPOT /
PUMP 1HP MRS 230V
50HZ
D80, SQT80, SQ885,
MRS400, ES400:
ELFRAMO SPA

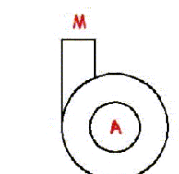

A=52mm, M=52mm,

C34: ELFRAMO SPA

1 hp, 230v

1103862 POMPA
0.8KW 220/240-50 E55 /
PUMP 0.8KW 220 / 240-
50 E55
130147:
ELETTROBAR

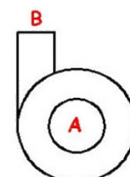

A=50mm, B=60mm

1103566 POMPA
0,80KW 220/240
COLGED /
PUMP 0,80KW 220/240
COLGED
GS60:
ELETTROBAR

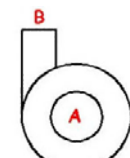

= 3109090, = 3110054,
A=60mm, B=51mm,
HOSE=2108257

1103290 POMPA
1,2HP 230V /
PUMP 1,2HP 230V



a= 60mm, m= 50mm,
X=1103445, Y= 3109116,
W= 2104005, Z=3110018

1103304 POMPA
1,2HP 230V /
PUMP 1,2HP 230V



a= 60mm, m= 48mm,
X=1103438, Y=3109028,
W=2104005, Z=3110027

1103662 ELETTROPO
MPA 1,2HP 230V
MODULAR /
PUMP 1,2HP 230V
MODULAR
OPT120, OPT1210:
MODULAR SPA

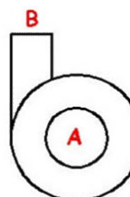

A=50mm, M=50mm

1103174 POMPA
LAVAGGIO 1,2 HP
MONOFASE /
MONOPHASE WASH
PUMP 1,2HP
LS805:
RANCILIO SPA
1000: SILANOS SRL
800,900:
SILANOS SRL

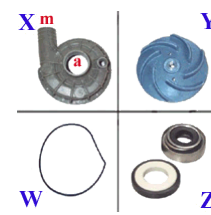

a= 63mm, m=48mm,
X=1103147, Y=3109024,
W= 2104001, Z=3110018

1103268 ELETTROPO
MPA 1,2HP MONOFASE
/ WATER PUMP
1PHASE 1,2HP
MS900: MACH



1103481 ELETTROPO
MPA 1,2 HP 230V
50/60Hz 2278 /
PUMP 1,2 HP 230V
50/60Hz 2278



1103138 POMPA
1,2HP 230/50-1 22/44 /
PUMP 1,2HP 230/50-1
22/44
E52, S651, S651P,
S653, S654, S655,
S830, S835:
ELETTROBAR
54: COLGED
D130068:
GIGA GRANDI
CUCINE SRL

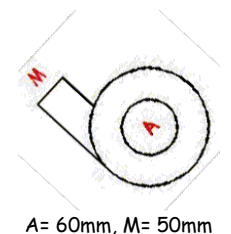

1103202 POMPA
1,2HP 230V /
PUMP 1,2HP 230V 50HZ
6S500-900, 66U:
DIHR-ALI SPA

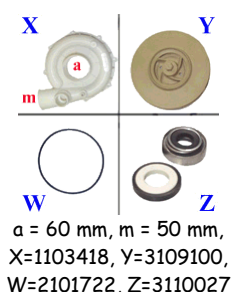

1103577 ELETTROPO
MPA KW1,0 MR 50HZ
MON 230V /
ELECTRIC PUMP KW1,
0 MR 230V 50HZ
00002591:
ELFRAMO SPA
00002513ex:
ELFRAMO SPA

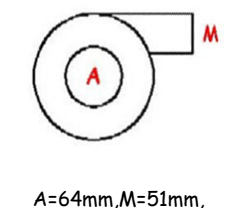

1103203 POMPA HP
1,5 230V MONO /
MONOPHASE PUMP
1,5HP 230V
6S100, GASTRO11S:
DIHR-ALI SPA



capacitor=1135006

1103521 MOTORE
POMPA LAVAGGIO HP
1,5 V 230 /
PUMP HP 1,5
6500: KRUPPS S.R.L.

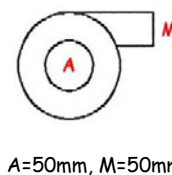

1103873 ELETTROPO
MPA 1100W 220-
240V/50HZ /
WASHING PUMP
1100W 220-240V/50HZ
80134:
ELETTROBAR

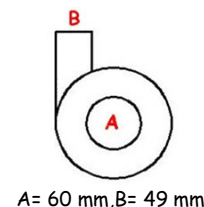

1103459 EU80114
ELETTROPOMPA
1,1KW 220-240V/50HZ
CON /
PUMP 1,1KW 220-
240V/50HZ
80113: ELETTROBAR
81114: ELETTROBAR
*: MBM
C80114: COLGED
EU80114EX: FAGOR
12026586: FAGOR

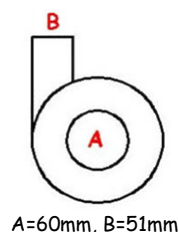

1103345 POMPA
MONOFASE HP 1,5
220/50Hz /
MONOPHASE PUMP HP
1,5 220/50Hz
9808M: A.T.A. SRL

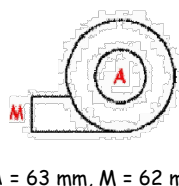

1103914 MOTORE
POMPA LAVAGGIO 1,5
HP T150 CHIOCC.90°
MOTORE PER 110 /
WASHING PUMP 1,5 HP
T150 - BODY PUMP 90°
6501:
KRUPPS S.R.L.

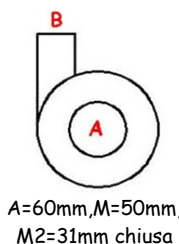

1103479 ELETTROPO
MPA 1,5HP 220V 1225 /
PUMP 1,5HP 220V 1225
A20005:
LINEA BLANCA



1103241 POMPA 0,20
HP 230/400V TRIFASE /
PUMP 0,20 HP 230/400V
EDT100,EDT140,EDT1
70,ET200, EDT230,
EDT85,;
HOONVED - ALI SPA
AC241, AC242, AC91,;
COMENDA ALI SPA



1103713 ELETTRON
PA 0,20HP 230/380V
60Hz TIPO 4226.6600 /
PUMP 0,20HP 230/380V
60Hz TYPE 4226.6600
100669:
COMENDA ALI SPA



1103732 POMPA
0,35KW TYPE 4226.241
380-400V / PUMP
0,35KW TYPE 4226.241
380-400V
100754: COMENDA
ALI SPA



1103620 ELETTRON
MPA 0,5 HP 380V 3983 /
PUMP 0,5 HP 380V 3983

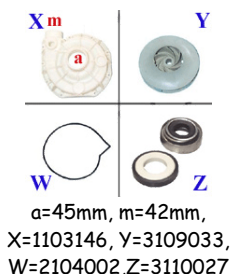

1103279 POMPA HP
0,5 230/380 /
WATER PUMP HP 0,5
230/380
10064:
COMENDA ALI SPA

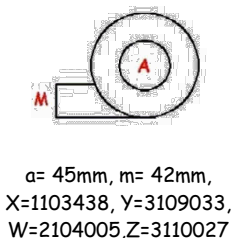

1103741 ELETTRON
MPA 1212.2500 HP0,5
V230/400 /
PUMP 1212.2500 HP0,5
V230/400

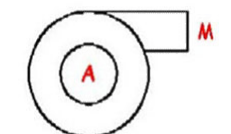

1103710 POMPA.HP.0
.6400V.50HZ /
PUMP
HP.0.6.400V.50HZ
100825:
COMENDA ALI SPA

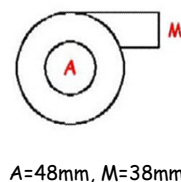

1103079 POMPA 0,75
HP 230/400V 1211 /
PUMP 0,75HP 230/400V
1211
1103079:
UNIVERSALE



1103231 POMPA 0,75
HP 230/380/415V /
PUMP 0,75 HP
230/380/415V



1103234 POMPA
0,75HP 230/415 /
PUMP ZANUSSI 0,75HP
230/415
841161: TEIKOS SRL
LS540D:
ELECTROLUX
PROFESSIONAL
S.P.A.



1103386 POMPA HP
0,75 400V /
PUMP HP 0,75 400V
40228: ADLER S.P.A.

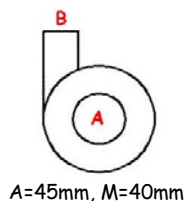

1103387 POMPA
0,75HP 380/400V 50HZ /
PUMP 0,75HP 380/400V
50HZ

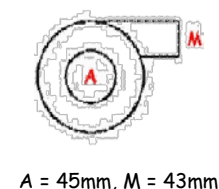

1103213 POMPA KW
0,55 230/400 /
PUMP 0,55 KW 230/400
0501088: **MEIKO**

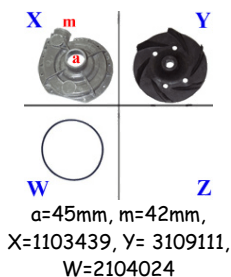

1103335 POMPA 1HP
230/400V 50HZ TRIF.
STATORE 55MM
GL/8,50 /
PUMP 1HP 230/400V
50HZ 3PHASES. 55MM
GL/8.50
PASSPORT 1040:
ARISTARCO SPA

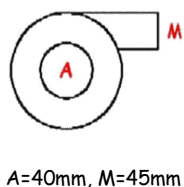

1103881 "POMPA
LAVAGGIO; ZF522VSX;
230V 1PH; 50HZ" /
WASHING PUM
ZF522VSX; 230V 1PH;
50HZ"
OL1914:
**ELECTROLUX
PROFESSIONAL
S.P.A.**

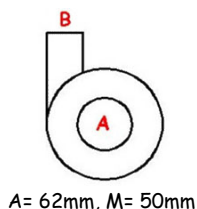

1103246 POMPA 1 HP
230/380 ZANUSSI
048304 /
PUMP ZANUSSI 1 HP
230/380 048304
ls7, ls8:
**ELECTROLUX
PROFESSIONAL
S.P.A.**



1103392 POMPA
LAVAGGIO; 220/380V
3P 60HZ 0,736KW /
WASH PUMP 220/380V
3P 60HZ 0,736KW
048503:
**ELECTROLUX
PROFESSIONAL
S.P.A.**



1103168 POMPA 1HP
220/380/50V TRIFASE
COMENDA 1219 /
THREE-PHASE PUMP
COMENDA 1HP
220/380/50V 1219
C85, LF400, F90M:
COMENDA ALI SPA



1103081 POMPA 1 HP
220/380V 1295 /
PUMP 1HP 220/380V
1295
LS705, LS805:
RANCILIO SPA
130024: **ELETTROBAR**
*1000: **SILANOS SRL**
1103081:
UNIVERSALE
MS700E, MS900:
MACH
A720, A500: **ADLER**
DV80: **MEIKO**



1103618 ELETTROPO
MPA 1HP 380V 1219 /
PUMP 1HP 380V 1219
100386:
COMENDA ALI SPA



1103849 ELETTROPO
MPA 0,075KW 400V
4217B2720 /
ELECTROPUMP
0,075KW 400V
4217B2720
40254: **ADLER S.P.A.**

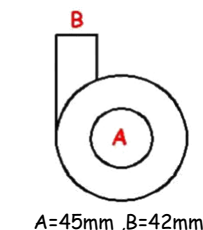

1103235 POMPA 1HP
380V /
PUMP 1HP 380V
AF88: **A.T.A. SRL**

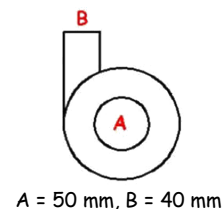

1103321 POMPA HP
1,2 V230/400 NP80 /
PUMP 1,2HP 230/400V
NP80
NP80, P80:
**GRUPPO CIMBALI
SPA**



1103891 MOTORE
POMPA LAVAGGIO 1,2
HP ASPIRAZIONE
D.56MM /
WATER PUMP 1,2HP
SUCTION DIAMETER
D.56MM
8201: **KRUPPS S.R.L.**

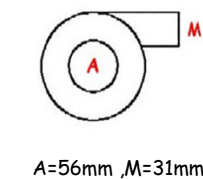

1103572 POMPA;
230-400V - 50 HZ. 1,34
HP ZF523V SX /
PUMP 230-400V 50HZ
ZF523V SX

OL0564:

ELECTROLUX
PROFESSIONAL
S.P.A.

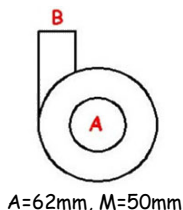

1103163 POMPA
1,5CV 380/3V 50HZ /
PUMP 1,5CV 380/3V
50HZ

AT95, AT112:
A.T.A. SRL



1103204 POMPA HP
1,5 220/380V 50HZ 3F /
THREE-PHASE PUMP
1,5HP 220/380V 50HZ

GASTRO 1200S:
DIHR-ALI SPA



1103035 POMPA
LAVAGGIO HP1,5
230/400 /
WASH PUMP 1,5HP
230/400V

TEIKOS SRL
66, S850, S870:
ELETTROBAR
100634:
COMENDA ALI SPA
MLC50, MLC65:
MARENO INDUSTRIE
ALI SPA
LS1105:
RANCILIO SPA
1300, 1300S:
SILANOS SRL
MS1100: MACH
D130025:



GIGA GRANDI
CUCINE SRL
LC5, LC50, LC65:
LASA SRL

1103205 POMPA HP
1,5 220/380V 50HZ 3F
G12S /
THREE-PHASE PUMP
1,5HP 220/380V 50HZ
G12S

GASTRO 12S:
DIHR-ALI SPA
S651, S654, S810,
S815, S830, S835:
ELETTROBAR



DIVISIONE DELLA EUROTEC SRL

1103379 POMPA
1,1KW
ELETTRO/ COLGED 380V

/
PUMP 1,1KW
ELETTRO/ COLGED
75175:

ELETTROBAR
DIVISIONE DELLA
EUROTEC SRL

*:
MBM- EUROTEC SRL -
DIV. COOKING
SERVICE

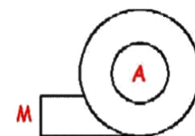

1103744 ELETTRORO
MPA 1,1KW 230/400V
2254.1000 /
PUMP 1,1KW 230/400V
2254.1000



1103669 POMPA
1,5HP 380V /
PUMP 1.5 HP 380V

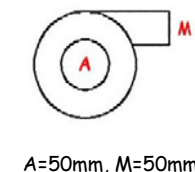

1103853 POMPA
LAVAGGIO 1,5HP 380V
LC3800 LINEA
BLANCA A020023 /
WASH PUMP 380V
1,5HP LC3800 LINEA
BLANCA A020023
A020023:
LINEA BLANCA



1103436 ELETTRORO
MPA 1,5H CE 150
V220/380-240/41 /
PUMP 1,5H CE 150
V220/380-240/41

926146:
ELETTROBAR
DIVISIONE DELLA
EUROTEC SRL
*:
MBM- EUROTEC
SRL - DIV. COOKING
SERVICE
L62: COLGED

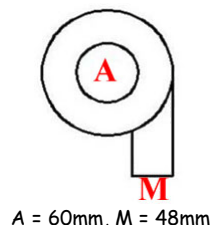

1103495 POMPA 1,35
KW 400/3/50 N1300 /
PUMP 1,35 KW 400/3/50
N1300
902322:
SILANOS SRL

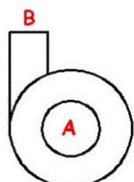

girante=3109025,
A=63mm, B= 49mm

1103714 POMPA
KW1.30 1235 RIVER
82/83 /
PUMP KW1.30 1235
RIVER 82/83
80115:
ELETTROBAR
DIVISIONE DELLA
EUROTEC SRL

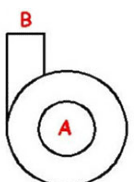

A=63mm, B=50mm

1103230 POMPA
1,4KW 230/400V /
PUMP 1,4KW 230/400V
E65, E140:
ELETTROBAR
12,14,120:
ELETTROBAR
S59, S63: COLGED
64: COLGED



A=63mm, M=48mm,
X=1103142, Y=3109156

1103030 POMPA 2HP
380V 50HZ N.T. D60 /
PUMP 2HP 380V 50HZ
N.T. D60
AT95, AT108:
A.T.A. SRL

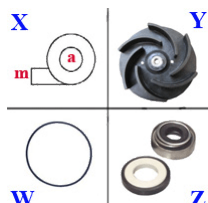

a=63mm, m=63mm,
X=1103562, Y=3109133,
W= 2101036,Z=3110018

1103046 POMPA
TRIFASE 2HP 2254/S /
THREE-PHASE PUMP
2HP 2254/S
048216:
ELECTROLUX
PROFESSIONAL
S.P.A.

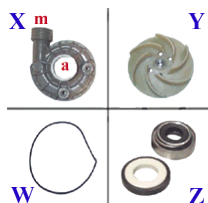

a= 74mm, m= 61mm,
X=1103130, Y=3109035,
W= 2104001,Z=3110018

1103099 POMPA 2 HP
230/400V 50HZ
TRIFASE /
THREE-PHASE PUMP
2HP 230/400V 50HZ
LP1: DIHR-ALI SPA
1103099:
UNIVERSALE

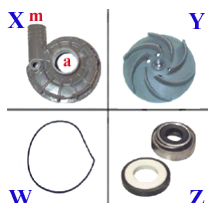
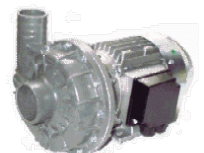

a= 63mm, m= 48mm,
X=1103144, Y=3109030,
W= 2104001,Z=3110018

1103689 ELETTROPO
MPA 2HP TIPO 1226
230/380V /
PUMP 2HP TYPE 1226
230/380V



a= 63mm, m= 48mm,
X=1103144, Y=3109030,
W= 2104001,Z=3110018

1103717 POMPA
ZANUSSI 2HP 380V /
PUMP ZANUSSI 2HP
380V

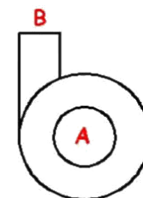

A=63mm, B=63mm

1103557 ELETTROPO
MPA 4290 2HP 220/380V
/
PUMP 4290
OL0039:
ELECTROLUX
PROFESSIONAL
S.P.A.

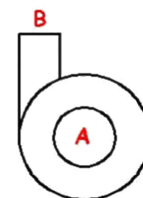

A=63mm, B=63mm

1103449 ELETTROPO
MPA KW1,5 MR 50HZ
TRI 400V /
PUMP KW1,5 MR 50HZ
TRI 400V
00002521ex:
ELFRAMO SPA
20160061:
ELFRAMO SPA
00002520ex:
ELFRAMO SPA

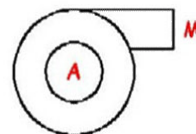

A = 63mm, M = 51mm

1103171 POMPA
2,7HP 230/400V /
PUMP 2,7HP 230/400V



a= 63mm, m= 48mm,
X=1103142, Y=3109088,
W=2104001,Z=3110018

1103270 POMPA
220/380 2,7HP A.PO' /
WATER PUMP 220/380
2,7HP A.PO
32M1480:
ANGELO PO GRANDI
CUCINE SPA
MLP60, MLP60E:
MACH
P700:
AMBER DI AFFABA
FRANCESCO & C.
929162: ELETTROBAR



a= 63mm, m= 50mm,
X=1103144, Y= 3109040,
W= 2104021, Z=3110018

1103471 ELETTROPO
MPA KRUPPS 2,7HP
380V /
PUMP KRUPPS 2,7HP
380V

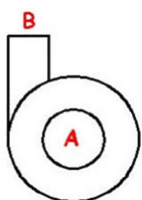

A= 63mm, B= 51mm

1103522 MOTORE
POMPA LAVAGGIO HP
2,7 /
PUMP HP 2,7
6600: KRUPPS S.R.L.



A=62mm, B=50mm,
X=1103609, Y=3109157,
W=2104032, Z=3110063

1103348 POMPA 3 HP
380V 50Hz ALP01 /
PUMP 3 HP 380V 50Hz
ALP01
14116: A.T.A. SRL

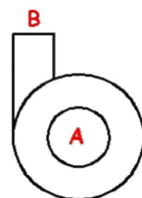

A=63mm, B=63mm

1103542 ELETTROPO
MPA CENTRIF.SX HP
3,2 /
ELECTROPUMP HP 3,2
30278:
HOONVED - ALI SPA

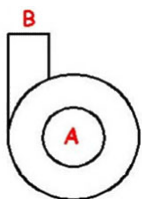

A=51mm, B=48mm

1103734 POMPA 2.35
KW 230/400V3 50HZ
ZF900SX /
PUMP 2.35 KW
230/400V3 50HZ SX
5698:
ARISTARCO SPA

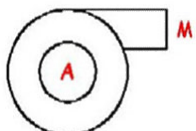

1103824 "POMPA; 3P
50HZ 2700W" /
PUMP: 3P 50HZ 2700W"
OK8525:
ELECTROLUX
PROFESSIONAL
S.P.A.

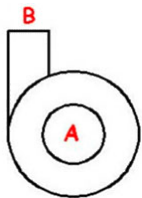

A=60mm, M=52mm

1103672 POMPA.HP.3
.7.220/380V.50HZ /
PUMP HP.3.7.220 /
380V.50HZ
100398: COMENDA
ALI SPA



A= 62mm, M= 62mm,
X=1103166, Y=3109074,

W= 2104013, Z=3110035

1103247 POMPA
3,7HP 230/400V 50HZ
2275 /
PUMP 3,7HP 230/400V
50HZ 2275
NE00, NE02, NE3001,
NE3002, NE4001,
NE4002, NE5002,
NE5501;



A= 62mm, M= 62mm,
X=1103166, Y= 3109074,
W=2104013, Z= 3110035

COMENDA ALI SPA
NE5502, NE7002,
NE7501, NE7502,
NE9001, NE9002,
NE9502:
COMENDA ALI SPA
31795:
HOONVED - ALI SPA
DW80912:
DIHR-ALI SPA

1103189 POMPA
AUM. PRESS. 220-
240/50 PICCOLA /
LITTLE PRESSURE
INCREASE PUMP 220-
240/50
DW15100D:
DIHR-ALI SPA



1103700 KIT
COMPONENTI POMPA
20160041 /
PUMP KIT 20160041
00222470:
ELFRAMO SPA



1103372 POMPA 0,15
HP OCEANO35-40 /
PUMP 0,15 HP
OCEANO35-40
OCEANO35, OCEANO4
0: LUXIA SRL



1103389 ELETTROPO
MPA 0,4H 220/240-50HZ
PSV45 /
PUMP 0,4H 220/240-
50HZ PSV46
DPE125R:
ELETTOBAR
*:
MBM- EUROTEC SRL -
DIV. COOKING
SERVICE
130120: ELETTOBAR



1103561 POMPA
AUMENTO PRESSIONE
0,43KW /
PRESSURE INCREASE
PUMP 0,43KW



1103190 POMPA
AUMENTO PRESS.
0,5HP 220/240V /
PRESSURE INCREASE
PUMP 0,50HP 220/240V
DW15100:
DIHR-ALI SPA



1103752 POMPA E
POZZETTO 400W DIHR
/
PUMP 400W DIHT
DW25024:
DIHR-ALI SPA



Ø1=66mm, Ø2=28mm,
Ø3=30mm, FAN=3109192

1103693 POZZETTO
&POMPA 190W 230/50
RL/09 /
PUMP 190W 230/50
RL/09
DW25021:
DIHR-ALI SPA



Ø1=50mm, Ø2=30mm,
Ø3=27mm

1103865 POMPA
HP0.45 230V 50HZ 2VIA
VER.04 /
PUMP HP0.45 230V 50
HZ
DW401402:
DIHR-ALI SPA

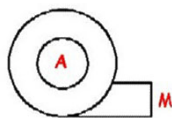

B= 31 mm, A= 47 mm

1103571 GRUPPO
POMPA RV54 +
COLLETT.ASP.810W /
PUMP RV54
130987:
ELETTROBAR
130987: COLGED



1103575 GRUPPO
CORPO LAVAGGIO +
POMPA E40 /
WASHING KIT + PUMP
E40
130998EX:
ELETTROBAR
999135:
ELETTROBAR
*: MBM



GASKET=2101428,
tappo=3101075,
body=4115484

1103576 GRUPPO
CORPO DI LAVAGGIO
+ POMPA E35 /
WASHING KIT + PUMP
E35
999134: ELETTROBAR
*:
MBM



GASKET=2101428,
tappo=3101075,

body=4115484

1103658 GRUPPO
POMPA RIV.40 +
CORPO PL. /
PUMP RIV.40
130993: ELETTROBAR



1103808 POMPA
LAVAGGIO 50HZ
PLUVIA 270 /
WASH PUMP PLUVIA
270 50HZ
130982: MBM
PLUVIA
270: ELETTROBAR
*: MBM



1103882 ELETTROPO
MPA LA50 500W.230/50-
1 /
ELECTROPUMP LGB
LA50LH 0.63HP
69120:
ELETTROBAR
DIVISIONE DELLA
EUROTEC SRL

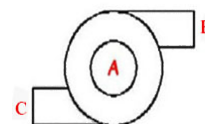

A=42mm, B=38mm,
C=25mm

1103901 ELETTROPO
MPA MONOFASE 500W
/
WASHING PUMP 230V-
500W
69122:
ELETTROBAR
DIVISIONE DELLA
EUROTEC SRL

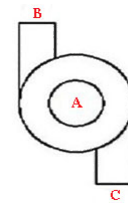

A=42mm, B=26mm,
C=38mm

1103761 POMPA 0,17
kW 230/1/50 SERIE S /
PUMP 230/1/50 0,17 kW
S SERIES
902258:
SILANOS SRL



1103317 POMPA
S/FLANGIA
ELETTROBAR
E35/E35H /
PUMP ELETTROBAR
E35/E35H
E35: ELETTROBAR
E35H: ELETTROBAR
T176: ELETTROBAR
BETA235: COLGED



= 3109121

1103134 POMPA E 40
/ WASH BODY GROUPE
+ PUMP E 40

E40:
ELETTROBAR
DIVISIONE DELLA
EUROTEC SRL
E40H:
ELETTROBAR
DIVISIONE DELLA
EUROTEC SRL
BETA240, SILVER
240: COLGED



X=3109097,Y=3110027

1103254 POMPA T-70
300W 220/230 50-1 /
PUMP T-70 300W
220/230 50-1

130117:
ELETTROBAR
43: COLGED

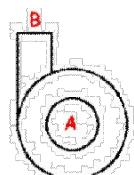

A=28mm, B=28mm

1103172 ELETTROPO
MPA 2 GIRANTI HP 0,50
/ WATER PUMP 2 PUMP
FAN HP0,50

APS43, APS48,
APS48B, APS53,
APS60:
HOONVED - ALI SPA

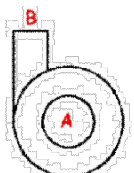

A=45mm, B=45mm,
SEAL=3110050

1103127 ELETTROPO
MPA 3 GIRANTI HP 0,75
/ PUMP 3 FAN 0,75HP

APS48, APS48B,
APS53, APS60:
HOONVED - ALI SPA

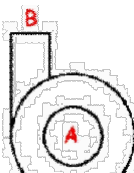

A = 32mm, B = 30mm,
0,75hp, 230v

1103320 POMPA 0,75
CON BOCCH32X1,5 /
PUMP 0,75HP 32X1,5

984150000:
GRUPPO CIMBALI
SPA
NAP43,45,SAP43,
SAP48,SAP60:
GRUPPO CIMBALI
SPA

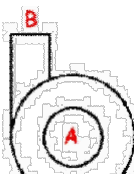

A = 45 mm, B = 45 mm

1103698 ELETTROPO
MPA PRESS.HP 0,85 /
PUMP HP 0,85

32956:
HOONVED - ALI SPA



1103840 POMPA
AUTODESCANTE JET
230V 1HP /
AUTO-DRAWING JET
PUMP 230V 1HP



1103888 MOTORE
KW 0.12 POLI 6 230/400
50 Hz /
MOTOR KW 0:12 - 6
POLES 230/400 50 Hz

5700:
ARISTARCO SPA



1103432 POMPA HP 4
230/400/50 SHE 50 /
PUMP HP 4 230/400/50
SHE 50

100697:
COMENDA ALI SPA



1103402 MTR.KW
0,1-0,15-380/3-S-AC-LSV
/ MOTOR KW 0,1-0,15-
380/3-S-AC-LSV

100246:
HOONVED - ALI SPA
100246:
COMENDA ALI SPA



1103719 MOTORE
0,18KW 63 B14 4POLI
230/400 IP55 /
MOTOR 0,18KW 63 B14
4P. 230/400 IP55

927107:
ELETTROBAR



1103448 MOTORE
180W MEC71 B5 - 8
POLI V230/400 /
MOTOR 180W MEC71
B5 - 8 POLES V230/400

927104:ELETTROBAR
*: MBM



1103288 POMPA
AUMENTO PRESSIONE
0,75 230/380/415 /
PRESSURE INCREASE
PUMP 0,75 230/380/415

902360:
SILANOS SRL



1103353 ELETTROPO
MPA PR.0,55KW
230/400V 50 /
ELECTROPUMP 0.55
KW 230 / 400V 50

100698:

COMENDA ALI SPA

100789:

COMENDA ALI SPA

100789:

HOONVED - ALI SPA



A=46mm,M=35mm

1103296 VENT.HP
0,75 220-415V V164/2 /
FAN MOTOR HP 0,75
220-415V V164/2

100509:

COMENDA ALI SPA



1103025 POMPA
AUMENTO PRESSIONE
0,50HP /
PRESSURE INCREASE
PUMP 0,50HP

1103025:

ELETTROBAR

1103025:

COMENDA ALI SPA

1103025:COLGED

1103025:

UNIVERSALE

C44/66:ELFRAMO

SPA



= 1125049, 0,50 hp, 230v,
pipe=2110050,
pipe=2110095,
pipe=2110056

1103133 ELETTROPO
MPA HP 0,50 PQM60 /
PUMP 0,50HP PQM60BZ
OT

0300361:

LAMBER DI AFFABA

FRANCESCO & C.



= 1125049

1103452 ELETTROPO
MPA PERIFERICA HP50
TRIFASE /
PUMP HP50
THREEPHASES

20160055:

ELFRAMO SPA

00047030:

ELFRAMO SPA

20160004ex:

ELFRAMO SPA



1103764 POMPA
AUTOADESCANTE
GIR.PER. KW0,37 - 230V
/
SELF-PRIMING PUMP
FOR. KW0, 37 - 230V



1103915 ELETTROPO
MPA AUMENTO
PRESSIONE PQm81
230V 0,7HP /
PRESSURE INCREASE
PUMP PQm81 230V
0,7HP



=1125092, 1/2"-1/2", 0,70
hp

1103027 KIT
UNIVERSALE POMPA
SCARICO 2 CALOTTE /
DRAIN PUMP
UNIVERSAL KIT

AL41E, AL46E, AF78E,
ED, EDP, AF88E:

A.T.A. SRL

AL40ET, AL45ET,

AL40E, AL45E,

AL40PS, AL45PS,;

A.T.A. SRL

130105: ELETTROBAR

65130105: RANCILIO

1103027:UNIVERSAL



230 V, body 1 Ø
23mm/23mm, body 2 Ø
30mm/34mm, 34 Watt

1103772 MOTORE
PER POMPA DI
SCARICO /
ENGINE FOR DRAIN
PUMP

4751: A.T.A. SRL



1103645 POMPA DI
SCARICO /
DRAIN PUMP

100519: I.T.V. S.A.

9041036*:

GRUPPO CIMBALI

SPA

984141000:

GRUPPO CIMBALI

SPA

926142:

BRICE ITALIA SRL



A=22mm, M=22mm,
COVER=1103670,
Dimensions 30-22 mm

1103552 POMPA
SCAR.HANNING DPS
25 50HZ /
DRAIN PUMP
HANNING DPS 25 50HZ

35093:

HOONVED - ALI SPA

100893:

COMENDA ALI SPA



A=30mm, M=23mm

1103450 POMPA KIT
/
PUMP KIT

0L0692:

ELECTROLUX

PROFESSIONAL

S.P.A.

048844EX:

ELECTROLUX

PROFESSIONAL

S.P.A.



1103709 POMPA
SCARICO RIVER /
DRAIN PUMP RIVER
80117: **ELETTROBAR**
130177: **ELETTROBAR**



1103788 POMPA DI
SCARICO 63043 /
DRAIN PUMP
CEPS51:
**OMNIWASH SRL -
SOCIETA' A SOCIO
UNICO**



diameter= 30mm //
23mm,

1103652 KIT
INSTALLAZIONE
POMPA DI SCARICO
35W /
DRAIN PUMP KIT 35W
DP50K: **KRUPPS S.R.L.**



1103680 POMPA SC.
4/82 220V 50HZ 63043 /
DRAIN PUMP 4/82 220V
50HZ 63043 EUR
CEPS5:
**OMNIWASH SRL -
SOCIETA' A SOCIO
UNICO**



1103670 CORPO
POMPA DI SCARICO /
DRAIN PUMP BODY



A=30mm, M=22mm

1103789 CALOTTA
PER POMPA 1103788 /
BODY FOR DRAIN
PUMP



1103910 CORPO
POMPA DI SCARICO /
BODY DRAIN PUMP



A=24mm, M=24mm

1103011 POMPA
LIQUIDI X SIMAG /
LIQUID PUMP SIMAG
ZIID005:

SIMAG SPA
1103011:
UNIVERSALE
K01530:
ARISTARCO SPA
1103011: **FAEMA**
DS4''DP, DS600DP, DL
240DP, CF35DP, CF40D
P, CF50DP, DS400:
ADLER S.P.A.
251002:
SCOTSMAN ICE SRL

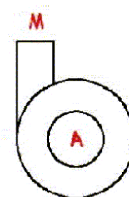

100W, A= 24mm, M=24mm

1103500 PUMP /
PUMP

CMCF62047100:
CASTEL MAC SPA
62047100:
SCOTSMAN ICE SRL



Ø1=18mm, Ø2=11mm

1103069 POMPA CLB
190W
FABBR.GHIACCIO/LAV
ATAZZE /
ICE MAKER PUMP
CLB 190W
*: **I.T.V. S.A.**
5010: **KRUPPS S.R.L.**
841104: **TEIKOS SRL**
1103069:

UNIVERSALE
MP-PS: **MACH**
1DR062: **MGEL S.R.L.**
GS202, GS215,
GS302, GS315:
**WINTERHALTER
ITALIA SRL**

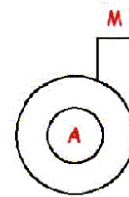

A= 24mm, M=24mm,
190 Watt, 230v

1103559 POMPA DI
SCARICO GRE CL.3 /
DRAIN PUMP GRE
CL.3

130112:
ELETTROBAR
DIVISIONE DELLA
EUROTEC SRL



1103417 POMPA DI
SCARICO 440V/60Hz /
DRAIN PUMP
440V/60HZ
FC543E:
COMENDA ALI SPA



1103364 POMPA
SC.100W 220V/50
C/FILTRO /
PUMP WITH FILTER
100W 220V/50
100803:
COMENDA ALI SPA



Ø2=22mm, H=172mm,
Ø1=30mm

1103207 POMPA DI
SCARICO SENZA
STAFFA /
DRAIN PUMP
WITHOUT STIRRUP
984141000:
GRUPPO CIMBALI
SPA
9041036:
GRUPPO CIMBALI
SPA
100342:
COMENDA ALI SPA

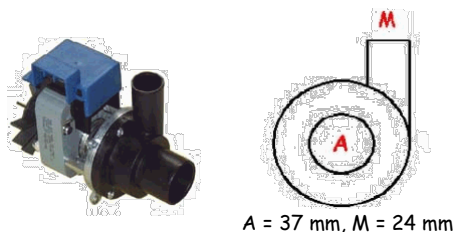

A = 37 mm, M = 24 mm

1103148 CORPO
POMPA 2211-2213 /
BODY PUMP 2211-2213
630131:
COMENDA ALI SPA

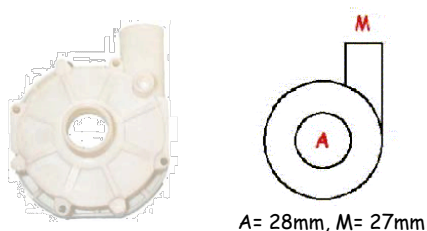

A= 28mm, M= 27mm

1103663 CHIOCCIOL
A POMPA LGB
ZF131DX /
BODY PUMP LGB
ZF131DX
630136:
COMENDA ALI SPA

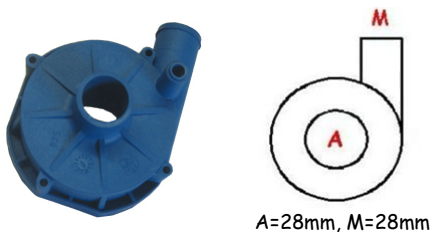

A=28mm, M=28mm

1103330 CORPO
POMPA DI LAVAGGIO
PER LAVABICCHIERI /
PUMP COVER
116020:
ELETTRORBAR
DIVISIONE DELLA
EUROTEC SRL



1103518 CHIOCCIOL
A MOTORE POMPA HP
0,25 /
BODY PUMP HP 0,25
6010: KRUPPS S.R.L.

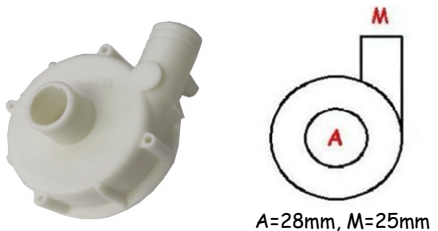

A=28mm, M=25mm

1103427 CORPO
POMPA DX T19 /
RIGHT BODY PUMP
T19

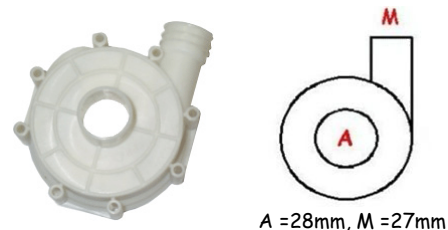

A =28mm, M =27mm

1103430 CHIOCCIOL
A PER POMPA 0,2HP /
BODY PUMP 0,2HP
36H1080:
ANGELO PO GRANDI
CUCINE SPA



1103467 CORPO
POMPA DI LAVAGGIO
PER LAVABICCHIERI /
BODY PUMP
*:
MBM- EUROTEC SRL
- DIV. COOKING
SERVICE
116018:
ELETTRORBAR
DIVISIONE DELLA
EUROTEC SRL



1103588 CORPO
POMPA HP 0,2 /
BODY PUMP 0,2HP
3822:
UNIVER-BAR SRL



1103421 CHIOCCIOL
A POMPA 0,33HP 1 VIA
/
BODY PUMP 0,33HP
DW18248:
DIHR-ALI SPA

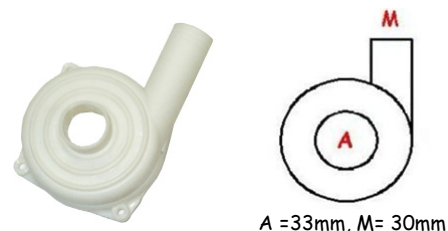

A =33mm, M= 30mm

1103306 CORPO
POMPA x=1103193 /
BODY PUMP
DW18247:
DIHR-ALI SPA

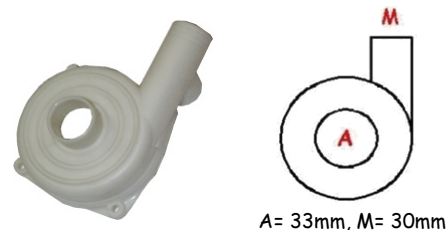

A= 33mm, M= 30mm

1103440 CORPO
POMPA B221A /
BODY PUMP B221A

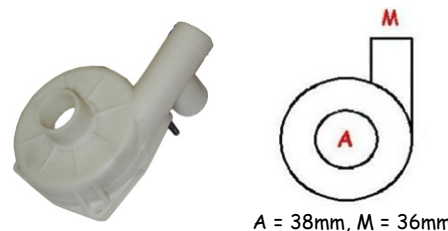

A = 38mm, M = 36mm

1103754 CORPO
POMPA /
BODY PUMP
DW15100V:
DIHR-ALI SPA



1103221 CORPO
POMPA /
PUMP BODY
DW7133:
DIHR-ALI SPA

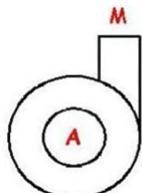

A = 29mm, M = 28mm

1103887 CHIOCCIOL
A POMPA 0,4 HP /
BODY PUMP 0.4 HP
1500:
UNIVER-BAR SRL

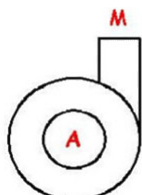

A=29mm, M=28mm

1103844 CORPO
POMPA 5213EB2450 /
BODY PUMP
5213EB2450



1103141 CORPO
POMPA /
BODY PUMP 1204-
1205-1241-1243
116005:
ELETTROBAR
DIVISIONE DELLA
EUROTEC SRL
630114:
COMENDA ALI SPA
H630114:
HOONVED - ALI SPA

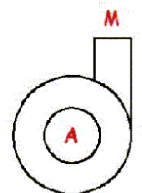

A = 63mm, M = 54mm

1103443 CORPO
POMPA 2204 /
BODY PUMP 2204

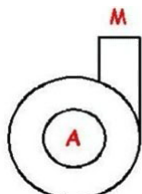

A = 63mm, M = 54mm

1103444 CORPO
POMPA B206 /
BODY PUMP B206

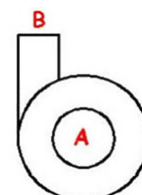

A = 45mm, B = 42mm

1103336 CORPO
POMPA 0226303 /
BODY PUMP 0226303

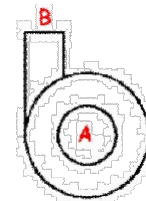

A = 33 mm, B = 31 mm

1103130 CORPO
POMPA /
BODY PUMP 2254

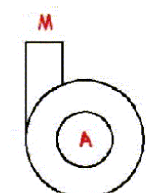

x 1103046, A = 74mm,
M = 61mm

1103131 FLANGIA
MOTORE C/CUFFIA /
FLANGE MOTOR
WITH CAP FOR 2254



x 1103046

1103139 CORPO
POMPA 1,5HP LGB /
BODY PUMP 1,5HP
LGB
901842:
SILANOS SRL

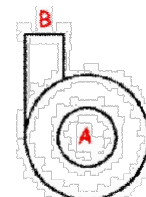

A = 57mm, B = 42mm

1103142 CORPO
POMPA /
BODY PUMP 1211

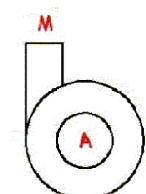

A = 63mm, M = 48mm

1103149 CORPO
POMPA 2212-2214-
B229-B274-2228 /
BODY PUMP 2212-
2214-B229-B274-2228
630120:
COMENDA ALI SPA
630125:
COMENDA ALI SPA

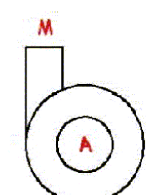
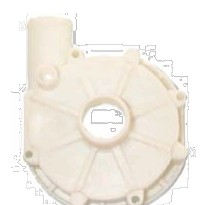

A = 28mm, M = 27mm

1103428 CORPO
POMPA SX T19 /
LEFT BODY PUMP T19

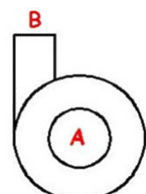

A = 28mm, B = 27mm

1103145 CORPO
POMPA /
BODY PUMP 1288-
2260-2286-4134-4333
984363000:
GRUPPO CIMBALI
SPA
26182:
HOONVED - ALI
SPA
9020018:
GRUPPO CIMBALI
SPA

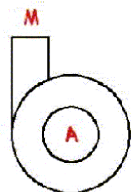
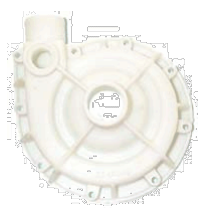

A= 30mm, M= 31mm

1103146 CORPO
POMPA 1292-2216-3911
/
BODY PUMP 1292-
2216-3911

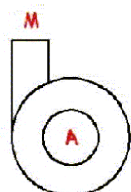
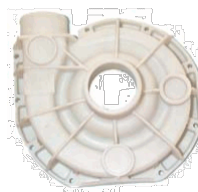

A= 45mm, M= 42mm

1103437 CORPO
POMPA 246 /
BODY PUMP 246

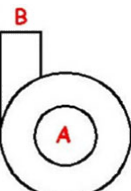

A = 46mm, B = 41mm

1103446 CORPO
POMPA 280 /
BODY PUMP 280

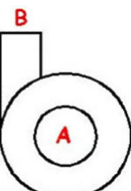

A = 45mm, B = 41mm

1103447 CORPO
POMPA 301 /
BODY PUMP 301

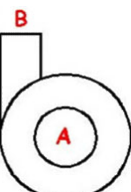

A = 45mm, B = 41mm

1103444 CORPO
POMPA B206 /
BODY PUMP B206

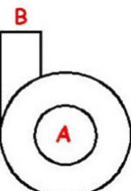

A = 45mm, B = 42mm

1103151 CORPO
POMPA 2292 /
BODY PUMP 2292

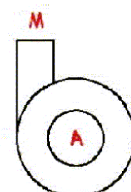

A= 45mm, M= 42mm

1103287 CORPO
POMPA 2247 F 0,5 HP /
PUMP COVER 2247 F
0,5HP
630129:
COMENDA ALI SPA

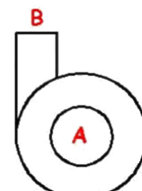

A = 38mm, B = 40mm

1103143 CORPO
POMPA /
BODY PUMP 1219A-
2227A-3983A
38223008:
RANCILIO SPA
26181:
HOONVED - ALI SPA

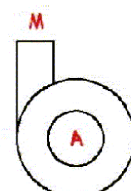

A= 45mm, M= 42mm

1103226 CORPO
POMPA 1 HP LGB /
PUMP BODY 1 HP LGB
630130:
COMENDA ALI SPA

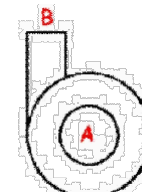

A=45mm, B=39mm

1103581 CORPO
POMPA /
BODY PUMP

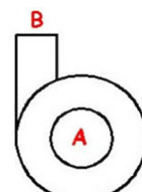

A=60mm, M=50mm

1103534 CORPO
POMPA /
BODY PUMP
OL0329:
ELECTROLUX
PROFESSIONAL
S.P.A.

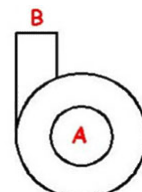
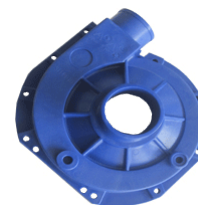

1103728 CORPO
POMPA PER 1103125
NUOVO TIPO /
BODY PUMP FOR
1103125 NEW MODEL

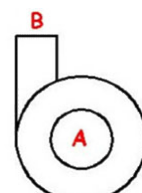

1103409 CORPO
POMPA 1219 /
BODY PUMP 1219

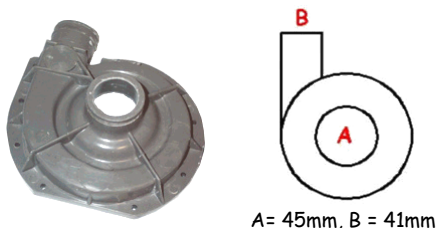

A= 45mm, B = 41mm

1103144 CORPO
POMPA /
BODY PUMP 1225-
1226-2241

116002:

ELETTROBAR
DIVISIONE DELLA
EUROTEC SRL

116004:

ELETTROBAR
DIVISIONE DELLA
EUROTEC SRL

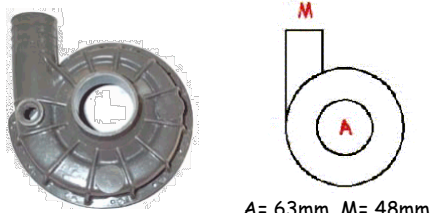

A= 63mm, M= 48mm

1103147 CORPO
POMPA 1293-1295 /
BODY PUMP 1293-1295

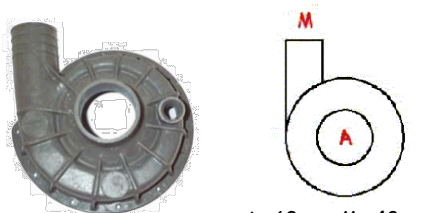

A= 63mm, M= 48mm

1103152 CORPO
POMPA B237 OLD /
BODY PUMP B237

*:
MBM- EUROTEC SRL
- DIV. COOKING
SERVICE

315017:

ELETTROBAR
DIVISIONE DELLA
EUROTEC SRL

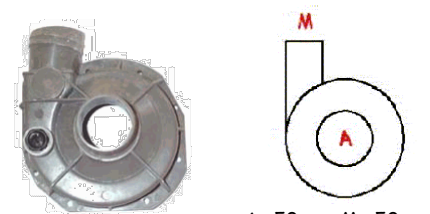

A= 50mm, M= 50mm

1103438 CORPO
POMPA 2233/4233 /
BODY PUMP 2233/4233
4741:

UNIVER-BAR SRL

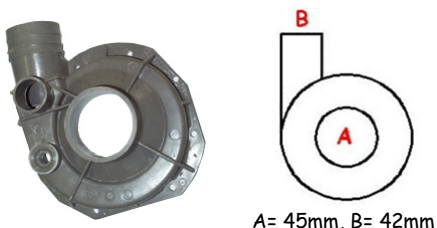

A= 45mm, B= 42mm

1103439 CORPO
POMPA 2256/1276 /
BODY PUMP 2256/1276

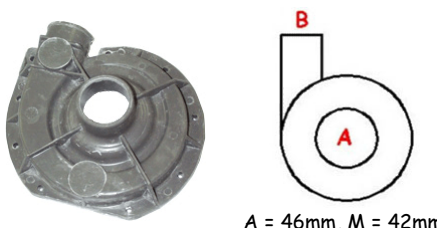

A = 46mm, M = 42mm

1103442 CORPO
POMPA 3911 /
BODY PUMP 3911

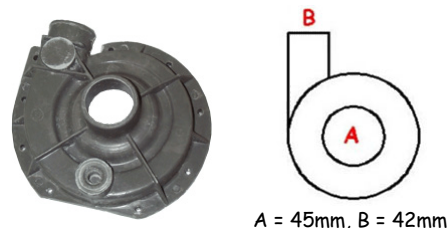

A = 45mm, B = 42mm

1103445 CORPO
POMPA 277 /
BODY PUMP 277

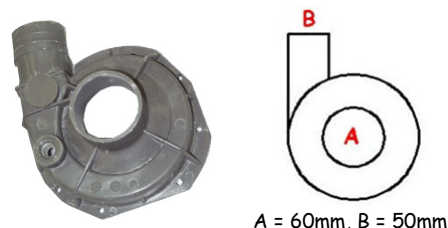

A = 60mm, B = 50mm

1103166 CORPO
POMPA 2275 /
BODY PUMP
1275303/W

DW80912C:

DIHR-ALI SPA

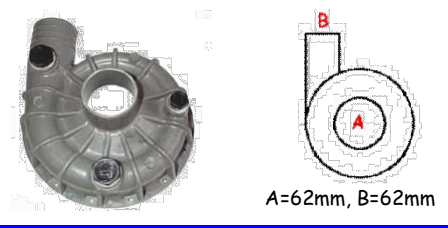

A=62mm, B=62mm

1103418 CHIOCCIOL
A POMPA 1,2HP /
BODY PUMP 1,2HP

DW15078:

DIHR-ALI SPA

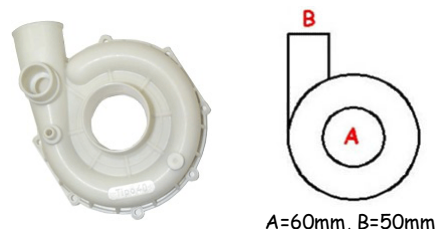

A=60mm, B=50mm

1103614 CHIOCCIOL
A POMPA HP 1,2
COSMO/COMPACT /
BODY PUMP HP 1,2
COSMO/COMPACT

6510: KRUPPS S.R.L.

6410: KRUPPS S.R.L.

4741*:

UNIVER-BAR SRL

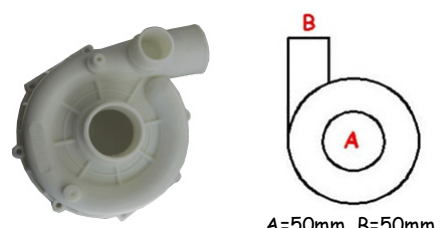

A=50mm, B=50mm

1103898 CHIOCCIOL
A MOTORE /
BODY PUMP

6520: KRUPPS S.R.L.

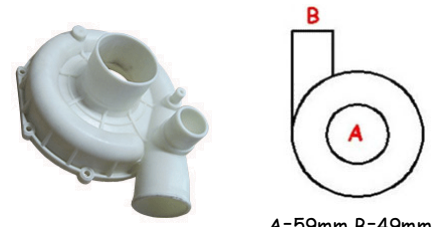

A=59mm, B=49mm

1103587 CHIOCCIOL
A POMPA HP 0,75 /
BODY PUMP 0,75HP

3351:

UNIVER-BAR SRL

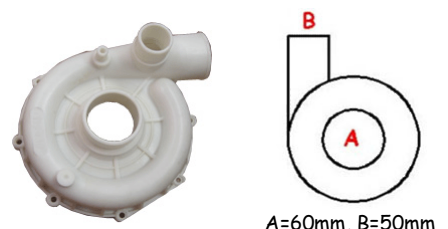

A=60mm, B=50mm

1103378 CORPO
POMPA S621 T30-1297 /
BODY PUMP S621 T30-
1297

116008:

ELETTROBAR
DIVISIONE DELLA
EUROTEC SRL

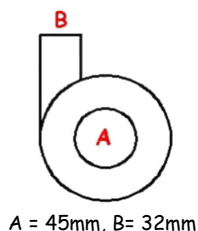

1103647 CHIOCCIOL
A KW1 MRS /
BODY PUMP KW1
MRS

00002700:

ELFRAMO SPA

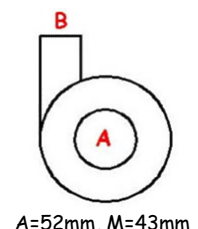

1103209 CHIOCCIOL
A KW 1/1,5 ELFRAMO /
BODY PUMP KW 1/1,5
ELFRAMO

00002710:

ELFRAMO SPA

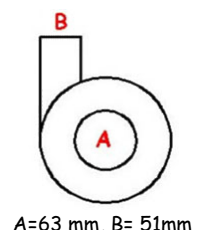

1103283 FLANGIA X
POMPA 053 OLD /
PUMP BODY 053

00210028:

ELFRAMO SPA

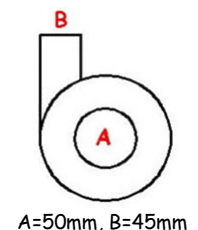

1103528 CHIOCCIOL
A POMPA 0,4 HP
(APERTA) /
BODY PUMP 0,4 HP

7686: A.T.A. SRL

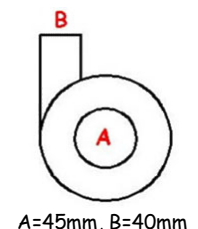

1103478 CORPO
POMPA ZF140 /
BODY PUMP ZF140

630135:

COMENDA ALI SPA
35496:
HOONVED - ALI SPA

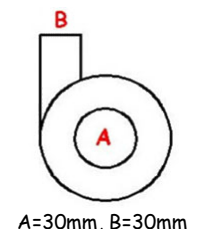

1103568 CORPO PER
POMPA DI LAVAGGIO
PER LAVASTOV /
BODY PUMP

116019:

ELETTROBAR
SILVER 50: COLGED

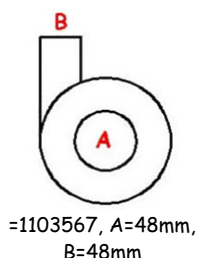

1103591 CHIOCCIOL

A PER
ELETTROPOMPA
ZF650 ZF800 /
BODY PUMP
ELECTRIC ZF650
ZF800

*:MBM

926086:

ELETTROBAR

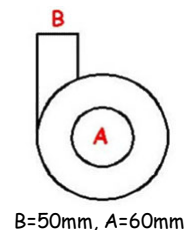

1103357 CORPO
POMPA EP30 /
BODY PUMP EP30

EP251TP:

OMNIWASH SRL -
SOCIETA' A SOCIO
UNICO

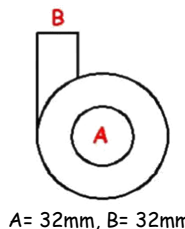

1103358 CORPO
POMPA EP100 /
BODY PUMP EP100

EP751TP:

OMNIWASH SRL -
SOCIETA' A SOCIO
UNICO

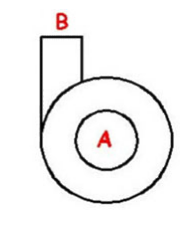

1103890 CHIOCCIOL
A POMPA ZF1200 /
BODY PUMP ZF 1200

630145:

COMENDA ALI SPA

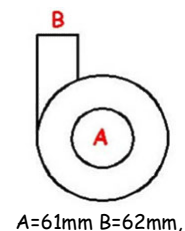

1103803 CORPO
POMPA 055 C&A /
BODY PUMP 055 C &
A

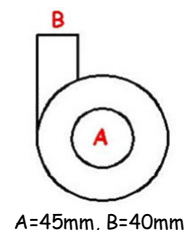

1103609 KIT
CHIOCCIOLA POMPA
HP 2,7 /
BODY PUMP HP 2,7

6810K: KRUPPS S.R.L.

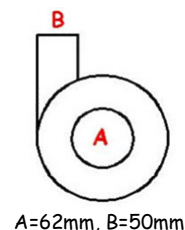

1103425 CORPO
POMPA DI LAVAGGIO
ASPIRAZIONE /
BODY PUMP PART

116024:

ELETTROBAR
*: MBM- EUROTEC
REB116024: COLGED
REB116024:
LOTUS SPA

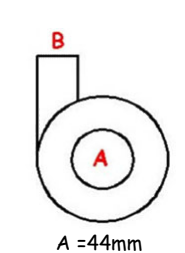
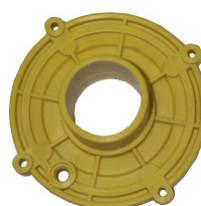

1103426 CORPO
POMPA COMPLETO
T90 /
BODY PUMP T90
COMPLETE

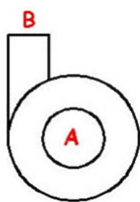

1103420 FLANGIA
T90 MANDATA /
FLANGE FOR BODY
PUMP T90

*: MBM- EUROTEC
SRL - DIV. COOKING
SERVICE

315020:

ELETTROBAR
DIVISIONE DELLA
EUROTEC SRL

REB315020:

LOTUS SPA

REB315020: COLGED

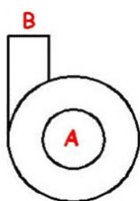

M= 30mm

1103422 CHIOCC.
POMPA 0,33HP
MANDATA GS40 /
BODY PUMP 0,33HP
GS40

DW135504:

DIHR-ALI SPA

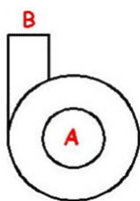

B =27mm

1103423 CHIOCCIOL
A POMPA 0.33HP
ASPIR. GS40 /
PUMP COVER 0,33HP
GS40

DW135503:

DIHR-ALI SPA



A= 39mm

1103424 CORPO
POMPA COMPLETO
1103194 /
PUMP COVER COMPL.
1103194

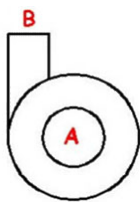

A= 39mm, B= 27mm

1103441 CORPO
POMPA 4186 /
BODY PUMP 4186



1103451 FLANGIA
POMPA X5 /
PUMP FLANGE X5

315027:

ELETTROBAR

*: MBM

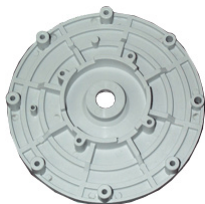

1103567 FLANGIA
PER POMPA DI
LAVAGGIO /
FLANGE

315022:

ELETTROBAR
DIVISIONE DELLA
EUROTEC SRL



=1103568

1103792 CORPO
POMPA FLANGIATO
ZF170 /
BODY PUMP FLANGE
ZF170

00210034:

ELFRAMO SPA



1103897 FLANGIA x
POMPA APS /
PUMP FLANGE -APS-
36060:

HOONVED - ALI SPA



Ø=44mm

1103895 CORPO
POMPA /
BODY PUMP

32601:

HOONVED - ALI SPA



A=48mm, M=45

1103413 CORPO
POMPA FLANGIATO
MR /
BODY PUMP MR

00002770:

ELFRAMO SPA

2770: ELFRAMO SPA



1103419 COPRIVEN
TOLA T60 /
FAN COVER T60

*:

MBM- EUROTEC SRL
- DIV. COOKING
SERVICE

313010:

ELETTROBAR
DIVISIONE DELLA
EUROTEC SRL

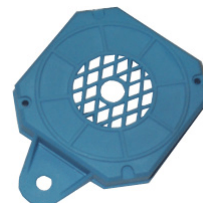

1103359 CALOTTA
MOTORE POMPA
EP100 /
MOTOR PUMP COVER
EP100

EP05:

OMNIWASH SRL -
SOCIETA' A SOCIO
UNICO



1103725 FLANGIA
POMPA 1225 /
PUMP FLANGE 1225



3109163 GIRANTE
POMPA C.A. 0.25HP /
IMPELLOR C.A. 0.25HP
4385:
ARISTARCO KASTEL
SPA

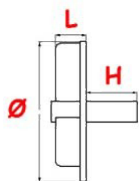

Ø=83mm, H=30mm

3109229 GIRANTE
POMPA /
PUMP FAN
0105R: **A.T.A. SRL**

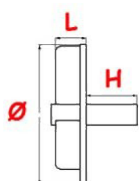

Ø= 71 mm, L= 17 mm, H= 11 mm

3109150 GIRANTE
POMPA 0,15 HP /
PUMP FAN 0,15HP
7651: **A.T.A. SRL**

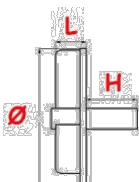

Ø=72 mm, L=18 mm,
H=32mm

3109042 GIRANTE
POMPA D. 42 /
IMPELLER PUMP D. 42
10066:
BREMA ICE MAKERS
SPA

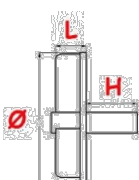
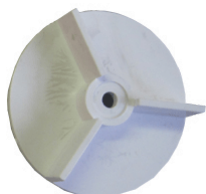

Ø = 72 mm, L = 18 mm

3109063 GIRANTE
POMPA 4226 D.75 MSL
/
PUMP FAN 4226 D.75
MSL
631675:
COMENDA ALI SPA

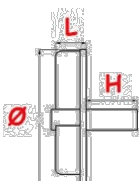

Ø = 72 mm, L= 22 mm,

3109051 GIRANTE
FIR D.72X18 /
PUMP FAN FIR D.
72X18
631640:
COMENDA ALI SPA



H=32 mm

3109223 GIRANTE A
50HZ PER
POMPA100827 Ø=85mm
/
IMPELLER Ø=85mm
632506:
COMENDA ALI SPA

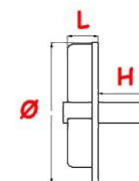

Ø=85mm,L=14mm,
H=9mm

3109174 GIRANTE
POMPA HP0.10 D.63 A.
/
PUMP FAN HP0.10 D.63
A.
DW10504:
DIHR-ALI SPA

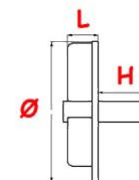

Ø=63mm

3109162 GIRANTE
LGB 0107 X ZF171 /
IMPELLER LGB 0107 X
ZF171
33841:
HOONVED - ALI SPA
35325:
HOONVED - ALI SPA

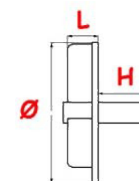

Ø=68mm,L= 17mm,
H=11mm

3109227 GIRANTE
POMPA 0,20 HP DX
LGB/
PUMP FAN 0,20 HP DX
LGB
903069:
SILANOS SRL

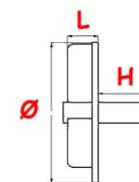

Ø=71mm,L=22mm,
H=12mm

3109169 GIRANTE
POMPA 0,20 HP SX
LGB ZF 131 /
IMPELLER PUMP .20
HP SX LGB ZF 131
903068:
SILANOS SRL

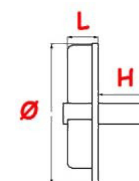

Ø= 72mm, L=18mm,
H=32mm

3109017 GIRANTE
POMPA 2211-2212-
2213-2214 /
PUMP FAN 2211-2212-
2213-2214
3821:
UNIVER-BAR SRL

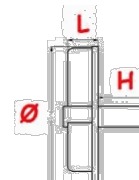

Ø= 72mm, L=18mm,
H=32mm

3109034 GIRANTE
POMPA 2228-B229 /
PUMP FAN 2228-B229

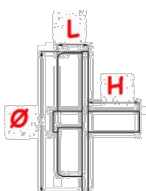

Ø= 72mm, L=22mm,
H=32mm

3109192 GIRANTE
DIHR SPECIALE /
DIHR IMPELLER
DW25024A:
DIHR-ALI SPA

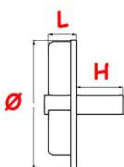

Ø=72mm

3109094 GIRANTE
POMPA 50 HZ 11 T-60
VECCHIO TIPO /
IMPELLOR PUMP
TYPE 50HZ 11 T-60
124028:
ELETTROBAR
DIVISIONE DELLA
EUROTEC SRL
*:
MBM- EUROTEC SRL
- DIV. COOKING
SERVICE



Ø = 80 mm

3109093 GIRANTE
POMPA 123 /
PUMP FAN 123
34339:
HOONVED - ALI SPA

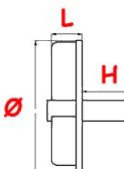

Ø = 80 mm

3109037 GIRANTE
POMPA B274 /
PUMP FAN B274

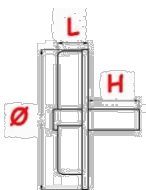

Ø= 72mm, L=20mm,
H=10mm

3109005 GIRANTE
APERTA 2286A-2286D /
OPENED FAN 2286A-
2286D
984360000:
GRUPPO CIMBALI
SPA
9190009:
GRUPPO CIMBALI
SPA

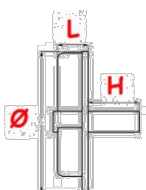

Ø= 80mm, L=21mm,
H=10mm

3109032 GIRANTE
POMPA 1288-2260 /
PUMP FAN 1288-2260

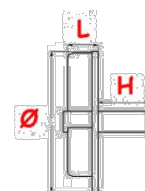

Ø= 84mm, L= 21mm,
H=10mm

3109065 GIRANTE
POMPA T-70 D80 /
PUMP FAN T-70 D.80
124042:
ELETTROBAR
DIVISIONE DELLA
EUROTEC SRL

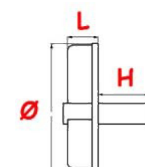

Ø=80mm

3109048 GIRANTE
D.86 ZF-140 /
PUMP FAN D.86 ZF-140
631695:
HOONVED - ALI SPA
631695:
COMENDA ALI SPA
35495:
HOONVED - ALI SPA

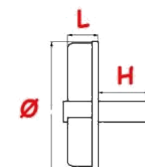

Ø = 86mm, L = 16mm,
H=16mm

3109036 GIRANTE
POMPA B237 /
PUMP FAN B237
REB124038: COLGED

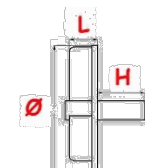

Ø= 94mm, L=32mm,
H=10mm

3109110 GIRANTE
POMPA B221 /
PUMP FAN B221

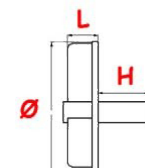

Ø = 80 mm, L=19mm,
H=10mm

3109205 GIRANTE
POMPA 055 C&A /
IMPELLER PUMP 055 C
& A
1371C&A:
ARISTARCO KASTEL
SPA



Ø=100mm

3109092 GIRANTE
POMPA 0,4 HP
(APERTA) /
PUMP FAN 0,4HP
7685: A.T.A. SRL
36G1460:
ANGELO PO GRANDI
CUCINE SPA

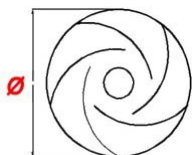

Ø = 90 mm

3109127 GIRANTE
POMPA 0,75 HP
(APERTA) C&A /
IMPELLOR PUMP
0,75HP
4702C&A: A.T.A. SRL



Ø = 100mm

3109133 GIRANTE
POMPA 2HP C.9806 AT
105/110/114/116 /
PUMP FAN 2HP C.9806
AT 105/11/114/116
14115: A.T.A. SRL

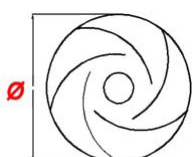

Ø=110mm

3109020 GIRANTE
POMPA 3911- /
PUMP FAN 3911
631619:
COMENDA ALI SPA
38223009:
RANCILIO SPA

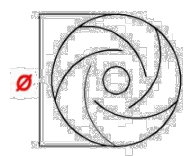

Ø= 95mm

3109028 GIRANTE
POMPA 1219-1292-
2292-2216-2284-2278 /
PUMP FAN 1219-1292-
2292-2216
631643:
COMENDA ALI SPA
631627:
COMENDA ALI SPA
34223:
HOONVED - ALI SPA

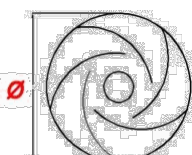

Ø= 103mm

3109046 GIRANTE
POMPA 1 HP LGB /
PUMP FAN 1 HP LGB
631674:
COMENDA ALI SPA
34524:
HOONVED - ALI SPA

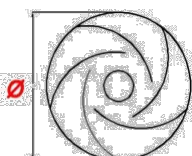

Ø=103mm

3109074 GIRANTE
POMPA 2275 /
PUMP FAN 2275
631628:
COMENDA ALI SPA

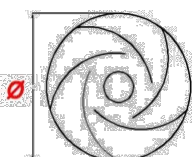

Ø = 135 mm

3109057 GIRANTE
PER POMPA /203 /
PUMP FAN 203
DW22009A:
DIHR-ALI SPA

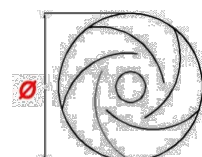

Ø = 102 mm

3109053 GIRANTE
PER POMPA /206 /
PUMP FAN 206
DW22045:
DIHR-ALI SPA

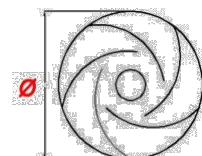

Ø=118mm

3109125 GIRANTE
PER POMPA 50HZ T30-
1297 /
PUMP FAN 50HZ T30-
1297
124006:
ELETTOBAR
DIVISIONE DELLA
EUROTEC SRL

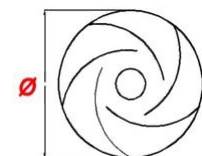

Ø = 83mm

3109176 GIRANTE+I
NSERTO
POMPA(2398R) /
IMPELLER (2398R)
124057:
ELETTOBAR
DIVISIONE DELLA
EUROTEC SRL



Ø=85mm

3109115 GIRANTE
POMPA 277 /
PUMP FAN 277
926152:
ELETTOBAR
DIVISIONE DELLA
EUROTEC SRL
*:
MBM- EUROTEC SRL
- DIV. COOKING
SERVICE



Ø = 103mm

3109156 GIRANTE
PER ELETTOPOMPA
4225/1 /
IMPELLER PUMP FOR
4225/1
926149:
ELETTOBAR
DIVISIONE DELLA
EUROTEC SRL

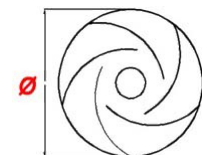

Ø=104mm

3109123 GIRANTE
POMPA ZF522 /
IMPELLOR ZF522

926275:

ELETTROBAR
DIVISIONE DELLA
EUROTEC SRL

35416:

HOONVED - ALI SPA

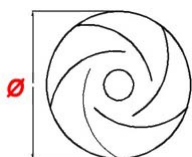

Ø =105mm

3109161 GIRANTE
PER ELETTROPOMPA
ZF650/CE150 /
PUMP FAN
FZ650/CE150

926085:

ELETTROBAR
DIVISIONE DELLA
EUROTEC SRL

*:

MBM- EUROTEC SRL
- DIV. COOKING
SERVICE

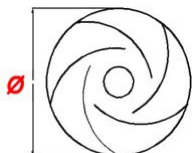

Ø=110mm

3109116 GIRANTE
POMPA 277 /
PUMP FAN 277

*:

MBM- EUROTEC SRL
- DIV. COOKING
SERVICE

124026:

ELETTROBAR
DIVISIONE DELLA
EUROTEC SRL



Ø =110mm

3109207 "GIRANTE;
50HZ" /
IMPELLER, 50HZ"

0E1305:

ELECTROLUX
PROFESSIONAL
S.P.A.



Ø=134mm

3109191 GIRANTE
PER POMPA 2250/75-
2250 /
IMPELLER PUMP
2250/75-2250

929181:

ELETTROBAR
DIVISIONE DELLA
EUROTEC SRL



Ø=135mm

3109073 GIRANTE
ELETTROPOMPA 0,25
/
PUMP FAN 0,25 HP

26205:

HOONVED - ALI SPA

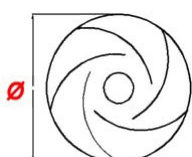

Ø=79mm

3109183 GIRANTE
DIAM.94 6 PALE M8SX
/
IMPELLER DIAM.94 6
PALE M8SX

33843:

HOONVED - ALI SPA

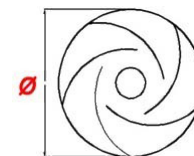

Ø=94mm

3109003 GIRANTE
PER ELETTROPOMPA /
PUMP FAN

31576:

HOONVED - ALI SPA

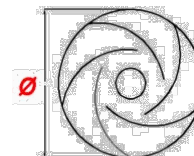

Ø= 95mm

3109077 GIRANTE
POMPA APERTA
HP0,75 HNV /
PUMP FAN HP0,75
HNV

26206:

HOONVED - ALI SPA



Ø = 96 mm

3109145 GIRANTE
ELETTROP.HP 2,7-3 SX
/
PUMP FAN HP 2,7-3 SX

27237:

HOONVED - ALI SPA



Ø=125mm

3109217 GIRANTE
MOTORE POMPA HP
0,45 /
IMPELLER PUMP
MOTOR HP 0,45

8411: KRUPPS S.R.L.



Ø=74mm

3109138 GIRANTE
MOTORE POMPA HP
0,5 /
IMPELLER FOR PUMP
HP 0,5

6211: KRUPPS S.R.L.



Ø=100mm

3109141 GIRANTE
MOTORE POMPA HP
1,5 -
PUMP MOTOR ROTOR
HP 1,5 / PUMP FAN HP
1,5

6511: KRUPPS S.R.L.



Ø=105mm

3109139 GIRANTE
MOTORE POMPA HP
0,75-
PUMP MOTOR ROTOR
HP 0,7 / PUMP FAN HP
0,7

6411: KRUPPS S.R.L.
3352:
UNIVER-BAR SRL

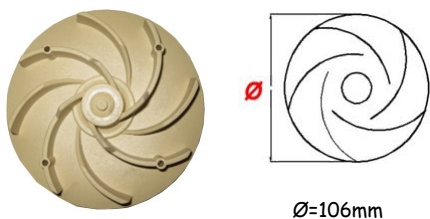

3109157 GIRANTE
MOTORE POMPA HP
2,7 /
PUMP FAN 2,7HP
6811: KRUPPS S.R.L.

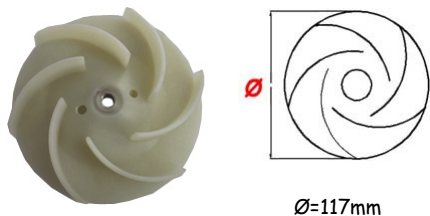

3109142 GIRANTE
MOTORE POMPA HP
2,7 - PUMP MOTOR
ROTOR HP 2,7 /
PUMP FAN HP 2,7
6611: KRUPPS S.R.L.

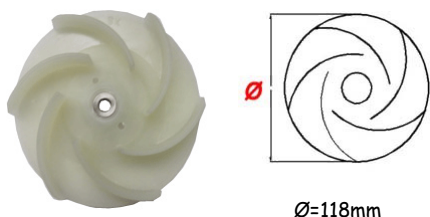

3109143 GIRANTE
MOTORE POMPA HP
3,0 -
PUMP MOTOR ROTOR
HP 3,0 / PUMP FAN HP
3,0
6711: KRUPPS S.R.L.

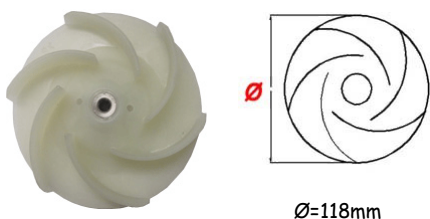

3109079 GIRANTE
POMPA EP 30 /
PUMP FAN EP 30
EP253:
OMNIWASH SRL -
SOCIETA' A SOCIO
UNICO

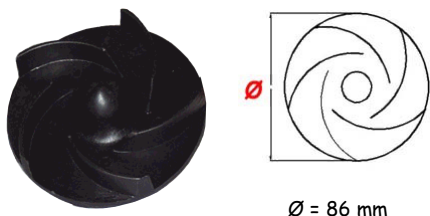

3109080 GIRANTE
POMPA EP 100 /
IMPELLOR EP 100
EP753:
OMNIWASH SRL -
SOCIETA' A SOCIO
UNICO

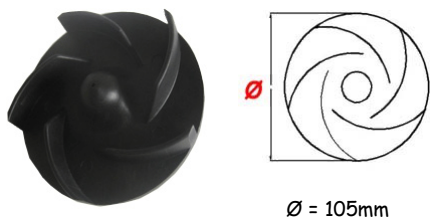

3109001 GIRANTE
POMPA 4134-4333- /
PUMP FAN 4134-4333-
38223028:
RANCILIO SPA
9090011:
GRUPPO CIMBALI
SPA
984361000:
GRUPPO CIMBALI

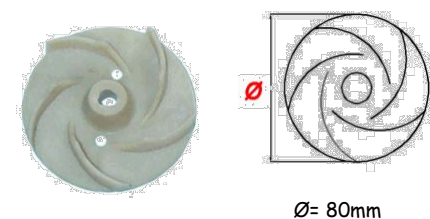

SPA

3109006 GIRANTE
APERTA D. 103
RANCILIO /
OPENED FAN D. 103
RANCILIO
38223029:
RANCILIO SPA

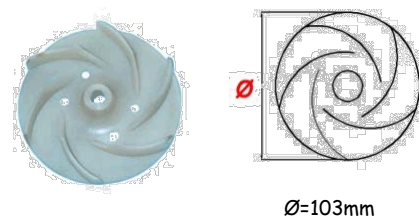

3109105 GIRANTE
POMPA 0,75 HP ZF320
0759/0713 LG /
PUMP FAN 0,75HP
ZF320 0759/0713 LG
903074:
SILANOS SRL

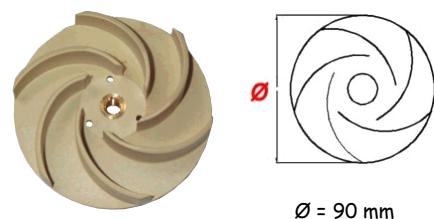

3109025 GIRANTE
POMPA 1,5HP 5225
LGB /
IMPELLER PUMP
1,5HP 5225 LGB
903121: SILANOS
SRL

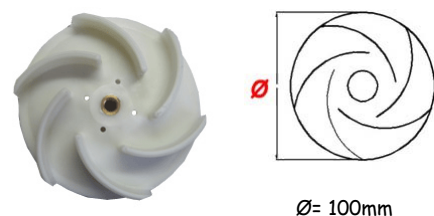

3109148 GIRANTE
POMPA HP 0,5 /
PUMP FAN HP 0,5
3731:
UNIVER-BAR SRL

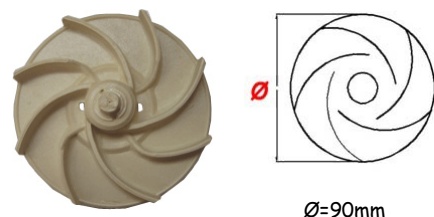

3109155 GIRANTE
POMPA HP 1,2
COSMO/COMPACT /
IMPELLER PUMP 1.2
HP COSMOS /
COMPACT
4743:
UNIVER-BAR SRL

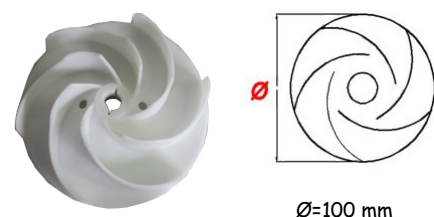

3109111 GIRANTE
POMPA 1276 /
PUMP FAN 1276

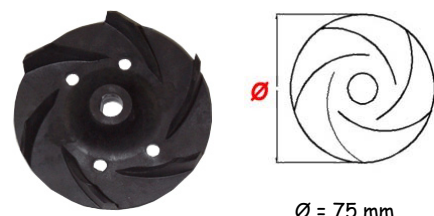

3109220 GIRANTE
ELETTOPOMPA
B257.1605 /
IMPELLER B257 ø 90
mm

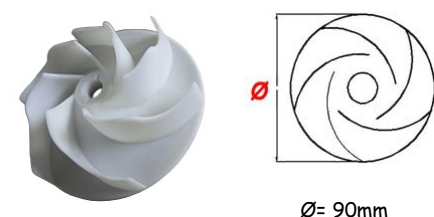

3109095 GIRANTE
POMPA B257 /
PUMP FAN B257

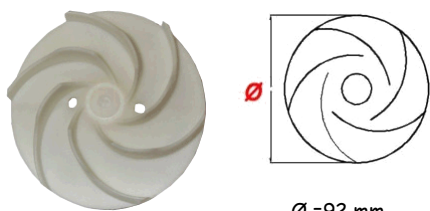

Ø = 92 mm

3109108 GIRANTE
POMPA 4255 /
PUMP FAN 4255



Ø=92mm

3109024 GIRANTE
POMPA 1211-1293-1295
/
PUMP FAN 1211-1293-
1295

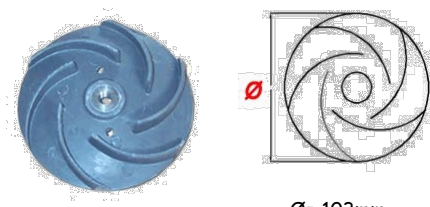

Ø= 103mm

3109114 GIRANTE
POMPA 268 /
PUMP FAN 268

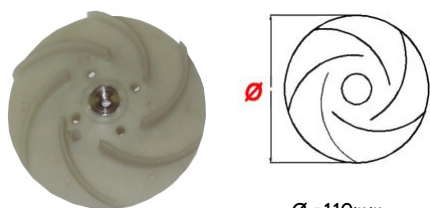

Ø = 110mm

3109029 GIRANTE
POMPA 1225-4225 /
PUMP FAN 1225-2241

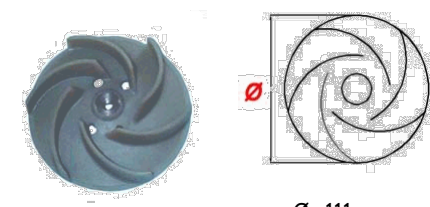

Ø= 111mm

3109035 GIRANTE
POMPA 2254S
ZANUSSI /
PUMP FAN 2254S

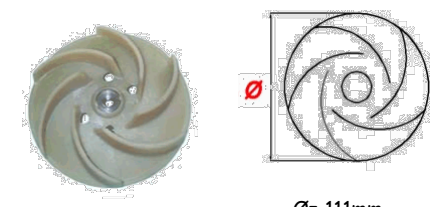

Ø= 111mm

3109209 GIRANTE
POMPA 268 D.118 /
IMPELLER PUMP 268
D.118

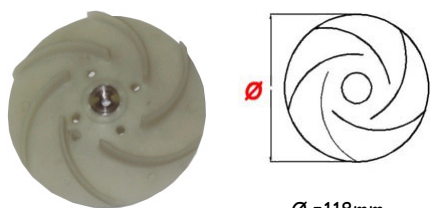

Ø = 118mm

3109088 GIRANTE
POMPA 2237 D.123 MM
M8 /
FAN FOR PUMP 2237
D. 123 MM M8

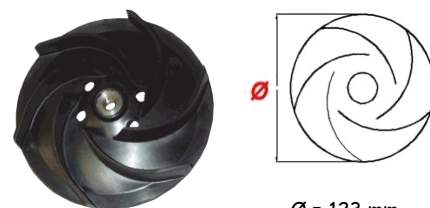

Ø = 123 mm

3109040 GIRANTE
POMPA 1227 /
PUMP FAN 1227

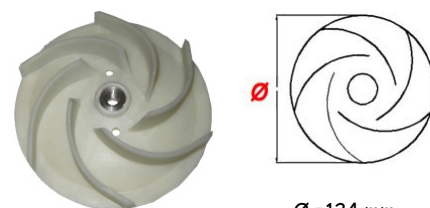

Ø = 124 mm

3109153 GIRANTE
POMPA 1,5HP /
PUMP FAN 1,5HP

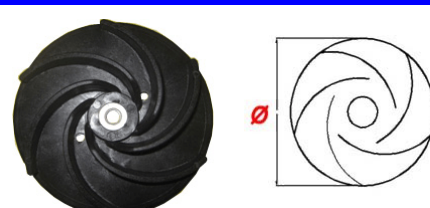

3109196 GIRANTE
POMPA 1226 X
WEXIODISK /
IMPELLER PUMP 1226
X WEXIODISK

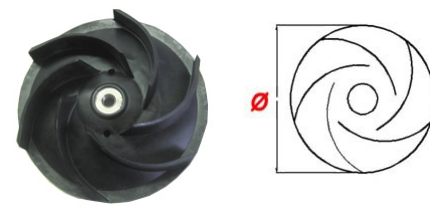

3109178 GIRANTE
POMPA Ø=92mm /
IMPELLER PUMP
Ø=92mm
2037R: A.T.A. SRL

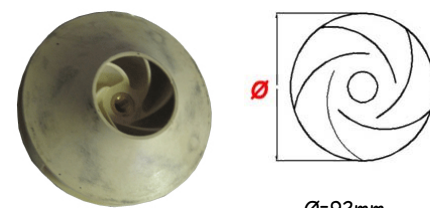

Ø=92mm

3109033 GIRANTE
POMPA 2227-3983-B279
/
PUMP FAN 2227-3983
631617:
COMENDA ALI SPA
26204:
HOONVED - ALI SPA

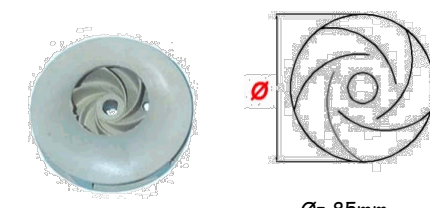

Ø= 85mm

3109128 GIRANTE
50HZ D.93 LGB
ZF350SX /
PUMP FAN 50HZ D.93
LGB ZF350SX
631703:
COMENDA ALI SPA

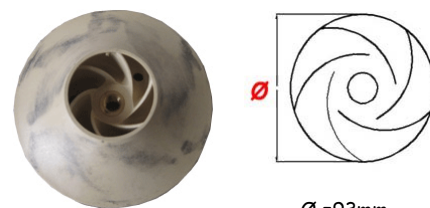

Ø = 93mm

3109204 GIRANTE
HP1 CHIUSA
D.103/2255 F. /
IMPELLER HP1
CLOSED D.103/2255 F.
631656:
COMENDA ALI SPA

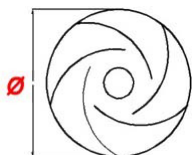

DIAMETER=103mm

3109099 GIRANTE
POMPA HP0.33 D.70 C.
GS40 /
PUMP FAN HP 0,33
D.70 C. GD40
DW135505:
DIHR-ALI SPA

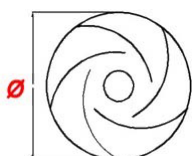

Ø = 74 mm

3109056 GIRANTE
PER POMPA /196 /
PUMP FAN 196
DW15079:
DIHR-ALI SPA

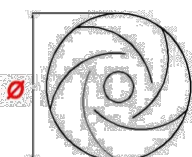

= 1103196, Ø=90mm

3109058 GIRANTE
PER POMPA /202 /
PUMP FAN 202
DW15079B:
DIHR-ALI SPA
DW15079F:
DIHR-ALI SPA

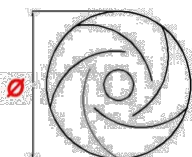

Ø=90mm

3109100 GIRANTE
POMPA HP1.2 D98
TIPO C /
PUMP FAN 1,2HP D98
TYPE C
DW15079C:
DIHR-ALI SPA

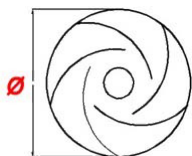

Ø = 98 mm

3109101 GIRANTE
POMPA D66.5 E35 T10 /
PUMP FAN D66.5 E35
T10
124046:ELETTROBAR
*:
MBM- EUROTEC SRL
- DIV. COOKING
SERVICE



Ø = 66 mm

3109121 GIRANTE
POMPA D.66.5 E35
T176 /
IMPELLER D.66.5 E35
T176
124048:
ELETTROBAR
DIVISIONE DELLA
EUROTEC SRL

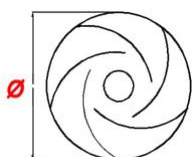

Ø =66,5mm

3109097 GIRANTE
POMPA D71.5 E40 T15 /
PUMP FAN D71.5 E40
T15



Ø = 71 mm

*:
MBM- EUROTEC SRL
- DIV. COOKING
SERVICE
124047:
ELETTROBAR
DIVISIONE DELLA
EUROTEC SRL

3109122 GIRANTE
POMPA D71,5 E40 T177
/
PUMP FAN D71,5 E40
T177



Ø =71,5mm

124049:
ELETTROBAR
DIVISIONE DELLA
EUROTEC SRL
*:
MBM- EUROTEC SRL
- DIV. COOKING
SERVICE

3109098 GIRANTE
PER POMPA PER
LAVABICCHIERI /
PUMP FAN



Ø = 85 mm

*:
MBM- EUROTEC SRL
- DIV. COOKING
SERVICE
124043:
ELETTROBAR
REB124043:
LOTUS SPA
REB124043: COLGED

3109160 GIRANTE
POMPA ZF400SX /
PUMP FAN ZF400SX
80845:
ELETTROBAR
DIVISIONE DELLA
EUROTEC SRL
00019541:
ELFRAMO SPA



Ø=101mm

3109090 GIRANTE
CHIUSO 50HZ D.104
T170 /
PUMP FAN 50HZ
?104mm T170 M8L
124031
: ELETTROBAR
DIVISIONE DELLA
EUROTEC SRL
RAG291: COLGED



Ø = 104 mm

3109118 GIRANTE
POMPA X5 /
PUMP FAN X5
124052:
ELETTOBAR
DIVISIONE DELLA
EUROTEC SRL

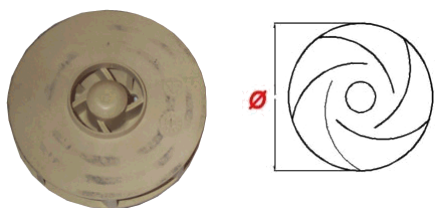

3109061 GIRANTE
POMPA ZF170SX /
PUMP FAN ZF170
46410600:
MODULAR SPA
00210036:
ELFRAMO SPA

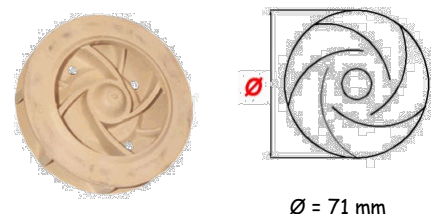

Ø = 71 mm

3109066 GIRANTE
POMPA KW0,3/0,5 - X
053 OLD /
IMPELLER KW0,3/0,5 -
X 053
00210039:
ELFRAMO SPA
D40: ELFRAMO SPA

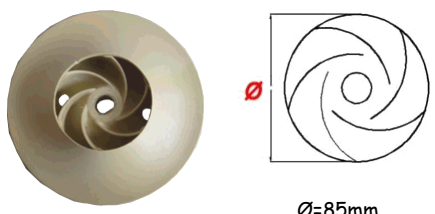

Ø=85mm

3109132 GIRANTE
POMPA KW0,75/50HZ
FILETTATA /
IMPELLOR PUMP KW
0,75/50HZ
D80F: ELFRAMO SPA

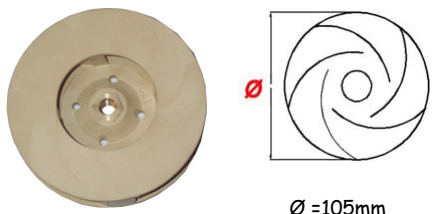

Ø =105mm

3109049 GIRANTE
KW 1,5 50HZ /
PUMP FAN KW 1,5
50HZ
00002870:
ELFRAMO SPA

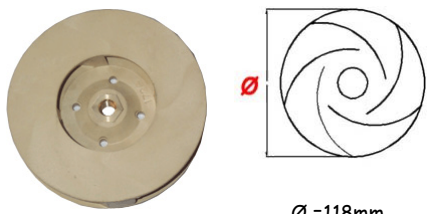

Ø =118mm

3109193 GIRANTE
ANTERIORE /
FRONT IMPELLER
9141045:
GRUPPO CIMBALI
SPA
984339000:
GRUPPO CIMBALI
SPA



3109194 GIRANTE
POSTERIORE /
REAR IMPELLER
984336000:
GRUPPO CIMBALI
SPA
9141044:
GRUPPO CIMBALI
SPA



3109021 GIRANTE
ALTA HOONVED /
IMPELLOR HOONVED
33166:
HOONVED - ALI SPA

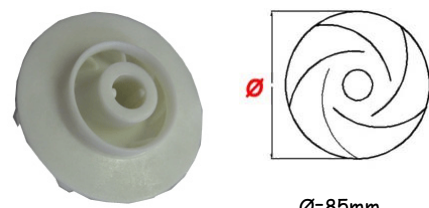

Ø=85mm

3109022 GIRANTE
BASSA HOONVED /
IMPELLOR HOONVED
33165:
HOONVED - ALI SPA

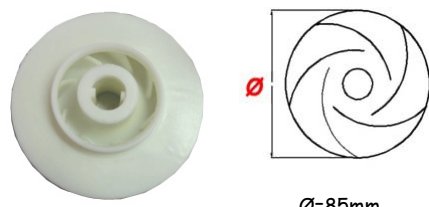

Ø=85mm

3109212 GIRANTE
ELETTOPOMPA A.P. /
IMPELLER
ELECTROPUMP AP
32346:
HOONVED - ALI SPA

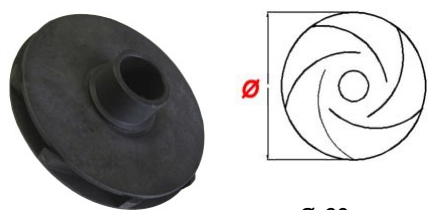

Ø=90mm

3109215 GIRANTE
ELETTOPOMPA
ACQUA PULITA /
FAN ELECTROPUMP
CLEAN WATER
32345:
HOONVED - ALI SPA

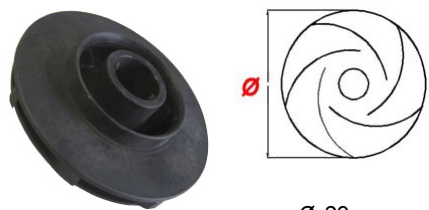

Ø=90mm

3109059 GIRANTE
POMPA 4247 /
PUMP FAN 4247
34318:
HOONVED - ALI SPA
631683:
COMENDA ALI SPA

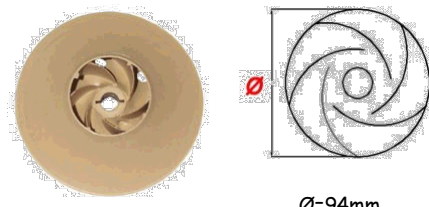

Ø=94mm

3109140 GIRANTE
MOTORE POMPA
0,7 /
PUMP FAN HP 0,75
6311: KRUPPS S.R.L.

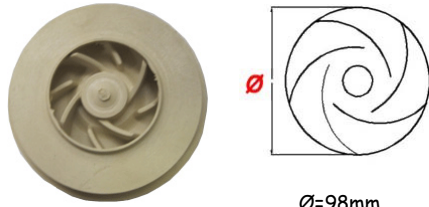

Ø=98mm

3109004 GIRANTE
CHIUSA D. 85
RANCILIO /
CLOSED FAN D.85
RANCILIO
38223025:
RANCILIO SPA

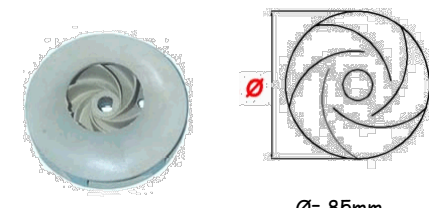

Ø= 85mm

3109222 Girante
pompa Hp 0,45 /
Impeller pump 0.45 Hp
1803:
UNIVER-BAR SRL

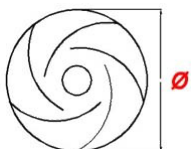

Ø= 80mm

3109211 GIRANTE
POMPA ASH175-80
DIA.87 /
IMPELLER PUMP
ASH175-80 DIA.87
38086:
HOONVED - ALI SPA

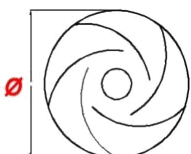

Ø =87mm

3109039 GIRANTE
POMPA 1237 /
PUMP FAN 1237

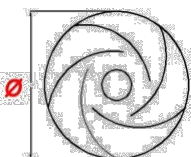

Ø = 90 mm

3109087 GIRANTE
DIHR /
FAN DIHR



Ø = 93 mm

3109081 GIRANTE
CHIUSA Ø103 PER
POMPA 168 /
PUMP FAN D. 103

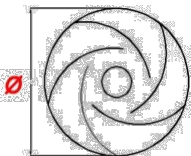

Ø = 103 mm

3109109 GIRANTE
POMPA 2256 /
PUMP FAN 2256

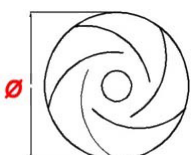

Ø=103mm

3109219 GIRANTE
FIR 5223 1HP 50HZ /
IMPELLER FIR 5223
50HZ 1HP
632501:
COMENDA ALI SPA



Ø= 100 mm

3109119 -GIRANTE
.HP2 D.100-60HZ-1204/5
F. /
PUMP FAN HP2 D.100-
60HZ-1204/5 F.
631647:
COMENDA ALI SPA

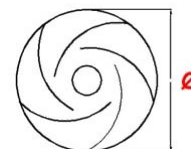

Ø =107mm

3109031 GIRANTE
POMPA 1241 /
PUMP FAN 1241
631653:
COMENDA ALI SPA

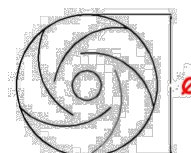

Ø= 111mm

3109026 GIRANTE
POMPA 1204 /
PUMP FAN 1204
631618:
COMENDA ALI SPA
H631618:
COMENDA ALI SPA
3102206:
WINTERHALTER
ITALIA SRL

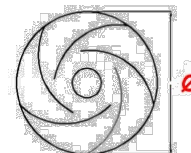

Ø= 118mm

3109159 GIRANTE
POMPA LGB ZF800DX
50HZ /
PUMP FAN LGB
ZF800DX
631692:
COMENDA ALI SPA

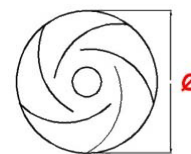

Ø=120mm

3109096 GIRANTE
POMPA HP0.33 D.80 A.
/
PUMP FAN 0,33HP D.
80
DW18246:
DIHR-ALI SPA

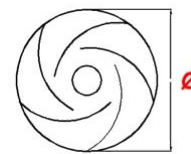

Ø = 80 mm

3109055 GIRANTE
PER POMPA /195 /
PUMP FAN 195
DW7135:
DIHR-ALI SPA

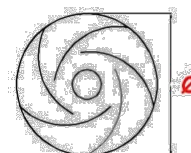

Ø=82mm

3109027 GIRANTE
POMPA 1205-1243 /
PUMP FAN 1205-1243
124014:
ELETTOBAR
DIVISIONE DELLA
EUROTEC SRL
631620:
COMENDA ALI SPA

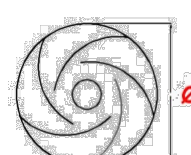

Ø= 124mm

RAG181: COLGED

3109083 GIRANTE
DIAM.105 6 PALE
M8DX /
PUMP FAN D.105
M8DX
33856:
HOONVED - ALI SPA

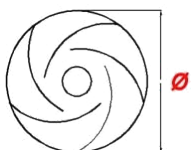

Ø = 105 mm

3109167 GIRANTE
115 6 PALE DX ZF 800 /
IMPELLER 115 6 PALE
DX ZF 800
34484EX:
HOONVED - ALI SPA
631725:
HOONVED - ALI SPA

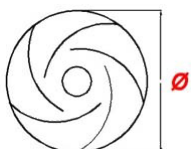

Ø=120mm

3109136 GIRANTE
MOTORE POMPA HP
0,25 /
PUMP FAN HP 0,25
6011: KRUPPS S.R.L.



Ø=75mm

3109137 GIRANTE
MOTORE POMPA HP
0,45 /
PUMP FAN HP 0,45
6111: KRUPPS S.R.L.

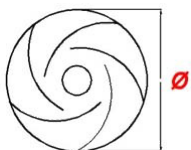

Ø=80mm

3109112 GIRANTE
POMPA 4186 /
PUMP FAN 4186



Ø = 85 mm

3109113 GIRANTE
POMPA 2204 /
PUMP FAN 2204

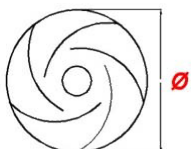

Ø =106mm

3109064 GIRANTE
POMPA 2241 /
PUMP FAN 2241

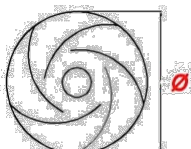

Ø=111mm

3109054 GIRANTE
PER POMPA /193 /
PUMP FAN 193
DW18259:
DIHR-ALI SPA

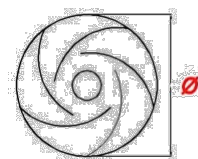

Ø=80mm

3109177 GIRANTE
POMPA /
IMPELLER

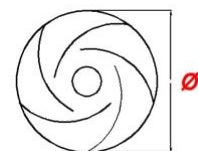

Ø=80mm

3109197 DIFFUSORE
ELETTROPOMPA A.P. /
ELECTRIC DIFFUSER
A.P.
32347:
HOONVED - ALI SPA



4120199 DIFFUSORE
POMPA SAP /
PUMP FAN SAP
984334000:
GRUPPO CIMBALI
SPA



3109202 VENTOLE
RAFF.HP.2-3 F.1204-44 /
COOLING FANS HP.2
F.1204-3-44
630306:
COMENDA ALI SPA





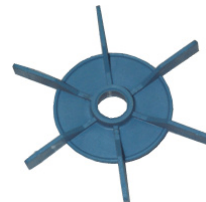







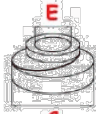





3109103 VENTOLA
T60 /
FAN T60
335008:
ELETTROBAR

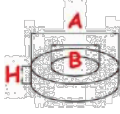

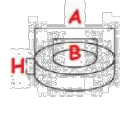

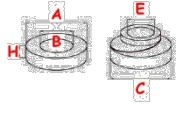

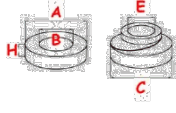

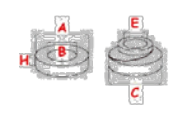

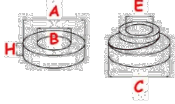

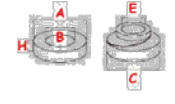

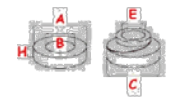

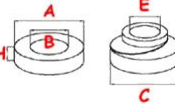

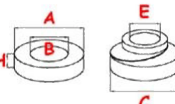
3109086 GIRANTE
1412042/B /
PUMP FAN 1412042/B













Ø = 108 mm

CODICE S&P S&P CODE		SCHEDA TECNICA DATA SHEET	ADATTABILITA' ADAPTABILITY
3110019		 E=10 mm; C=24,5 mm	
3110020		 E=11 mm; C=24,5 mm	
3110021		 E=12 mm; C=24,5 mm	OL0333: ZANUSSI
3110054		 E=13 mm; C=24,5 mm	
3110022		 A=26mm; B=14mm; H=5,5mm	OL0334: ZANUSSI
3110023		 A=26mm; B=14mm; H=8mm	
3110001		 E=11mm; C= 24.5mm; A=26mm; B= 14mm; H=5,5mm	44511006: RANCILIO SPA
3110017		 E=12mm; C= 24.5mm; A=26mm; B= 14mm; H=5,5mm	630530: COMENDA ALI SPA 9010013: HEMERSON SRL 33181: HOONVED SRL
3110025		 E=10mm; C= 24.5mm; A=26mm; B= 14mm; H=8mm	

CODICE S&P S&P CODE		SCHEDA TECNICA DATA SHEET	ADATTABILITA' ADAPTABILITY
3110026		 <p>E=11mm; C= 24.5mm; A=26mm; B= 14mm; H=5,5mm</p>	<p>900027: SILANOS SRL 903067: SILANOS SRL 7252: A.T.A. SRL 4703: A.T.A. SRL 630514: COMENDA ALI SPA 630511: COMENDA ALI SPA 630510: COMENDA ALI SPA 34182: HOONVED SRL H630510: HOONVED SRL H630523: HOONVED SRL 26134: HOONVED SRL 1395: UNIVER-BAR SRL DW10200055: DIHR-ALI SPA 048983: ELECTROLUX PROFESSIONAL S.P.A. 049171: ZANUSSI 048983: ZANUSSI</p>
3110027		 <p>E=11mm; C= 24.5mm; A=26mm; B= 14mm; H=8mm</p>	<p>4748: UNIVER-BAR SRL 048623: ZANUSSI</p>
3110031		 <p>E=13mm; C= 24.5mm; A=26mm; B= 14mm; H=5,5mm</p>	<p>141007: MBM DIVISIONE DELLA EUROTEC SRL 141007: ELETTOBAR DIVISIONE DELLA EUROTEC 06150006: ELFRAMO SPA 0K8387: ELECTROLUX PROFESSIONAL S.P.A. 8C1945: EMMEPI GRANDI CUCINE S.R.L. 0K8387: ZANUSSI 512063400: MACH</p>
3110078		 <p>E=12mm, C=24mm; B= 14mm, H=5.5mm, A=26mm</p>	<p>38795: HOONVED - ALI SPA</p>
3110035		 <p>E=17mm, C=39mm; B= 21mm, H=8mm, A=42mm</p>	
3110002			<p>44511020: RANCILIO SPA</p>
3110036			<p>9141043: GRUPPO CIMBALI SPA 984340000: GRUPPO CIMBALI SPA</p>

CODICE S&P S&P CODE		SCHEDA TECNICA DATA SHEET	ADATTABILITA' ADAPTABILITY
3110048			630504: COMENDA ALI SPA
3110037			
3110050			33810: HOONVED SRL
3110071			929179: ELETTROBAR DIVISIONE DELLA EUROTEC
3110074			38084: HOONVED - ALI SPA
3110077			630538: COMENDA ALI SPA

CODICE S&P S&P CODE		CAPACITA' ELETTRICA μ F CAPACITANCE μ F	ADATTABILITA' ADAPTABILITY
1135008		4 μ F	
1135007		5 μ F	206010: ELETTOBAR DIVISIONE DELLA EUROTEC SRL 631208: COMENDA ALI SPA 00300105: LAMBER DI AFFABA FRANCESCO & C. 3113034: WINTERHALTER ITALIA SRL
1135003		6,3 μ F	631216: COMENDA ALI SPA 0300110: LAMBER DI AFFABA FRANCESCO & C.
1135004		8 μ F	631201: COMENDA ALI SPA 32Z2490: ANGELO PO
1135001		10 μ F	180018: MAGISTER SISTEMA CAFFE' SRL 34020003: RANCILIO SPA 0300106: LAMBER DI AFFABA FRANCESCO & C. R65190180: LAINOX ALI SPA 531401600: CIMBALI
1135002		12,5 μ F	34020004: RANCILIO SPA CECN12: I.M.E. SRL 621207: COMENDA ALI SPA DW1581: DIHR-ALI SPA 047883: ZANUSSI 047541: ZANUSSI
1135006		16 μ F	3400016: RANCILIO SPA 206004: ELETTOBAR DIVISIONE DELLA EUROTEC SRL
1135005		18 μ F	
1135012		20 μ F	206005: ELETTOBAR DIVISIONE DELLA EUROTEC SRL
1135010		25 μ F	

2104049 76,6X2,62 O-RING NBR /
76,6X2,62 O-RING NBR
0042R: **A.T.A. SRL**

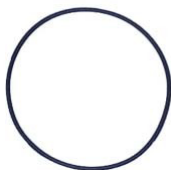

76,6X2,62

2104033 O.R. POMPA
0,75 HP (APERTA) /
O RING FOR PUMP
0,75HP
4704C&A: **A.T.A. SRL**

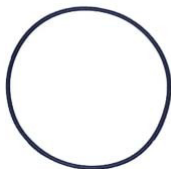

2104001 GUARNIZIO
N POMPA 1204-05-11-
1225-26-41-43-93-1295-
2241-54-37 /
PUMP GASKET 1204-05-
11-1225-26-41-43-93-
1295-2241-54

841519: **TEIKOS SRL**
456023:

ELETTROBAR
DIVISIONE DELLA
EUROTEC SRL

630411:
COMENDA ALI SPA
DW10200290:
DIHR-ALI SPA

H630411:
HOONVED - ALI SPA
4559:
UNIVER-BAR SRL

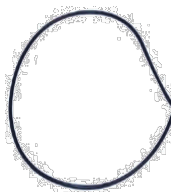

2104012 GUARNIZ.P
OMPA F.2247 0,5HP /
PUMP GASKET F2247
0,5 HP
630419:
COMENDA ALI SPA

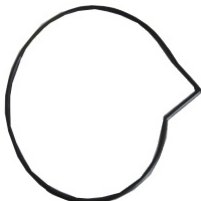

2104027 GUARNIZIO
NE OR X LGBZF350SX /
PUMP GASKET X
LGBZF350SX
630431:
COMENDA ALI SPA

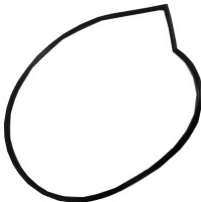

2104003 GUARNIZIO
NE POMPA 1288-2260-
86A-86D-4134-4333 /
PUMP GASKET 1288-
2260-86A-86D-4134-4333
9010010:
GRUPPO CIMBALI SPA

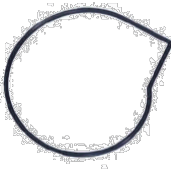

2104002 GUARNIZIO
NE POMPA 1219-92-
2216-27-92-3911-83 /
PUMP GASKET 1219-92-
2216-27-92-3911-83

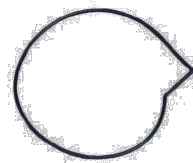

2104021 GUARNIZIO
NE POMPA 230/2204 /
PUMP GASKET
230/2204

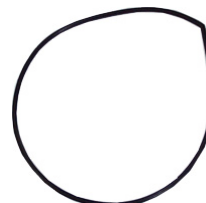

2104033 O.R. POMPA
0,75 HP (APERTA) /
O RING FOR PUMP
0,75HP
4704C&A: **A.T.A. SRL**

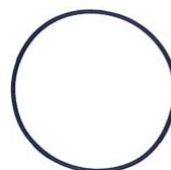

2104004 GUARNIZIO
NE POMPA 2211-2212-
2213-2214-2228-B229-
B274,236 /
PUMP GASKET 2211-
2212-2213-2214-2228-
B229-B274

630416:
COMENDA ALI SPA
65456038:
RANCILIO SPA

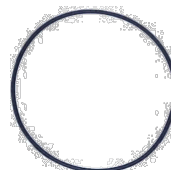

2104044 GUARNIZIO
NE POMPA
LAVAGGIO(ZF400SX-
2287) ART.1743R /
SEAL PUMP WASH
(ZF400SX-2287)
ART.1743R
80844:

ELETTROBAR
DIVISIONE DELLA
EUROTEC SRL

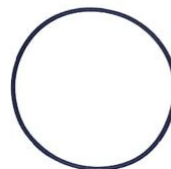

2104046 GUARNIZIO
NE OR CHIOCCIOLA
POMPA 75,00X2,50MM /
SEAL O-RING PUMP
75,00X2,50MM
6012: **KRUPPS S.R.L.**

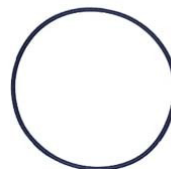

2104030 GUARNIZIO
NE CORPO POMPA HP
0,5/0,75 /
PUMP GASKET HP
0,5/0,75
1502:
UNIVER-BAR SRL

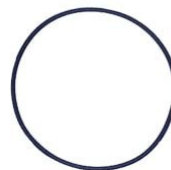

2104013 GUARNIZIO
NE CORPO POMPA /
BODY PUMP GASKET

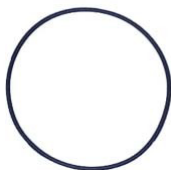

2104018 O-RING
107,62X2,62 OR3425 /
O-RING 107,62X2,62 -
OR3425

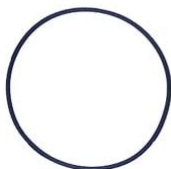

2104042 GUARNIZIO
NE POMPA 055 C&A /
PUMP GASKET 055 C &
A

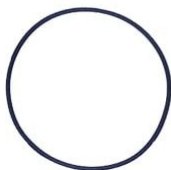

2102139 GUARNIZIO
NE FLANGIA POMPA
EP30/60 /
PUMP GASKET EP30/60
EP252NT:
OMNIWASH SRL -
SOCIETA' A SOCIO
UNICO



2104015 GUARNIZIO
NE POMPA EP 100 /
PUMP GASKET EP 100
EP752NT:
OMNIWASH SRL -
SOCIETA' A SOCIO
UNICO



2104038 GUARNIZIO
NE CORPO POMPA /
PUMP GASKET
26224:
HOONVED - ALI SPA



2102371 GUARNIZIO
NE X COPERCHIO
POMPA /
PUMP GASKET
26229:
HOONVED - ALI SPA



2104005 GUARNIZIO
NE POMPA B237 /
PUMP GASKET B237
4742:
UNIVER-BAR SRL
RAG52: COLGED



2104022 GUARNIZIO
NE POMPA 2256 /
PUMP GASKET 2256



2104026 GUARNIZIO
NE X POMPA HP 0,25
VECCHIO TIPO /
GASKET PUMP HP X
0.25 OLD TYPE



2108046 COLLARE
ASPIRAZIONE /
SUCTION COLLAR
COMPACT
20,MASTER:
ARISTARCO SPA

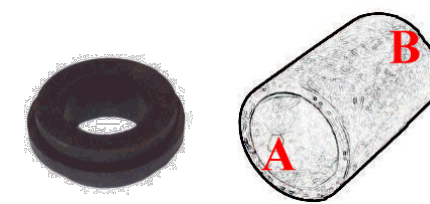

B=26mm, A=26mm

2108210 COLLETTO
RE GOMMA TELATA
GEMINI PROGRAM
DIS.1192 /
COLLECTOR RUBBER
- GEMINI PROGRAM
700:
ARISTARCO SPA

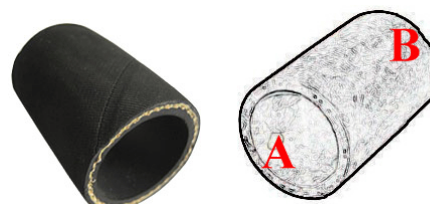

B=30mm, A=30mm

2108390 MANICOTT
O FLANGIA POMPA /
PUMP FLANGE
SLEEVE
2139:
ARISTARCO SPA



B=32mm, A=27mm

2108261 MANICOTT
O IN GOMMA MM30-38
A38-A40 DIS.1446 /
PRESSURE HOSE
MM30-38 A38-A40
4171:
ARISTARCO SPA



A=38mm, B=30mm

2108049 MANICOTT
O ASPIRAZIONE A35-
A38-A40 /
SUCTION SLEEVE
A35-A38-A40
PASSPORT
35.21/38.25/40.28:
ARISTARCO SPA



A=53mm, B=30mm,
RINGHOSE= 4115223

2108273 MANICOTT
O POMPA PROJECT
DIS. 451 /
PRESSURE HOSE
PROJECT
2157:
ARISTARCO SPA



B=40mm, A=40mm

2108224 MANICOTT
O ASP. MM45/55
SELF/2 DIS.656 /
SUCTION SLEEVE
MM45/55 SELF/2
DIS.656
2655:
ARISTARCO SPA



A= 45mm, B=54mm

2108355 MANICOTT
O X SCARICO EPDM 28
160 /
HOSE FOR
DISCHARGE (EPDM 28
160
K00110:
ARISTARCO SPA



2108389 MANICOTT
O MANDATA POMPA /
SLEEVE FLOW PUMP
7942: A.T.A. SRL

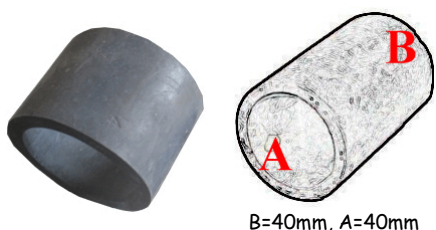

B=40mm, A=40mm

2108058 MANICOTT
O MANDATA POMPA
BC FC43 /
"OUTLET HOSE FOR
""BC-FC43"" PUMP"
200776:
COMENDA ALI SPA



A = 35mm, B = 25mm

2110077 TUBO
30X41 L45 PREM.
LAVAB. /
SLEEVE 30X41 L45
200319:
COMENDA ALI SPA

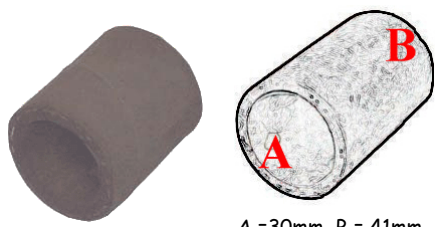

A = 30mm, B = 41mm

2108075 MANICOTT
O PREMENTE
LC380/C140 /
SLEEVE LC380/C140
200758:
COMENDA ALI SPA

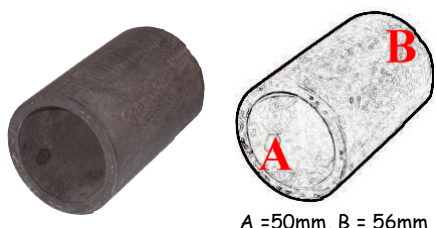

A = 50mm, B = 56mm

2108170 MANICOTT
O /
PRESSURE HOSE
200757:
COMENDA ALI SPA

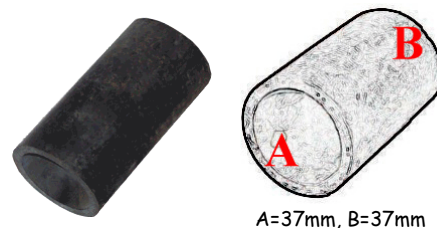

A=37mm, B=37mm

2108396 MANICOTT
O RACCORDO
LAVAGGIO
SUPERIORE C90E 07 /
HOSE FITTING WASH
UPPER C90E 07
H37646:
COMENDA ALI SPA
37646:
HOONVED - ALI SPA

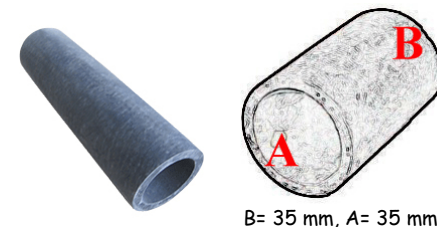

B= 35 mm, A= 35 mm

2108060 TUBO
MANDATA
COLONN.INF.BHC /
OUTLET HOSE BHC
201030:
COMENDA ALI SPA

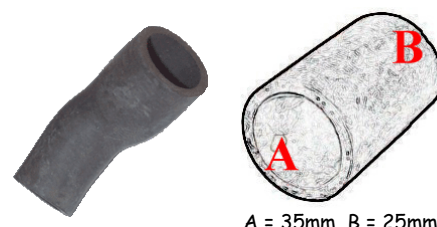

A = 35mm, B = 25mm

2108123 MANICOTT
O ASPIRAZIONE C95-
C155-C165 /
SUCTION SLEEVE C95-
C155-C165
200769:
COMENDA ALI SPA

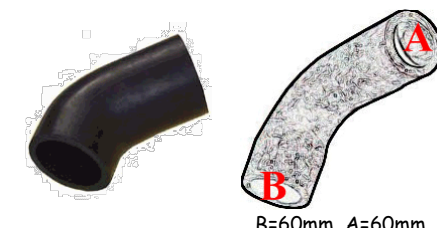

B=60mm, A=60mm

2108026 MANICOTT
O PREMENTE SCE /
LOT SLEEVE SCE
200762:
COMENDA ALI SPA



2108055 MANICOTT
O ASPIRAZ. B23-10-1-2
/
SUCTION SLEEVE B23-
10-1-2
B10-B12,B20-
B27,B10T-
B12T,LBR_LBR_H,LB
C_LBC_A:
COMENDA ALI SPA

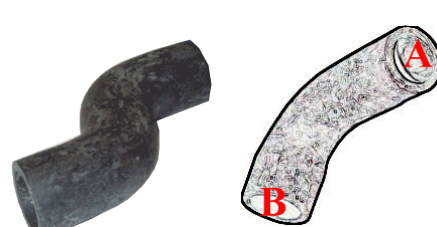

B=30mm, A=28mm

2108211 "TUBO
ASPIR.LAVAGGIO""AC
"""" /
SUCTION SLEEVE AC
200760:
COMENDA ALI SPA



2108059 MANICOTT
O ASPIRAZIONE
VASCA BHC / TANK
SUCTION SLEEVE
BHC
201029: **COMENDA**
ALI SPA

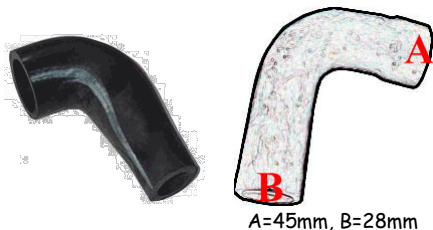

A=45mm, B=28mm

2108065 MANICOTT
O MAND. POMPA B41-
15-F20 /
PUMP OUTLET HOSE
B41-15-F20
200372:
COMENDA ALI SPA



A = 41mm, B = 35mm

2108187 MANICOTT
O DI ASPIRAZIONE
F80/LF450 /
SLEEVE INLET F80 /
LF450
200312:
COMENDA ALI SPA

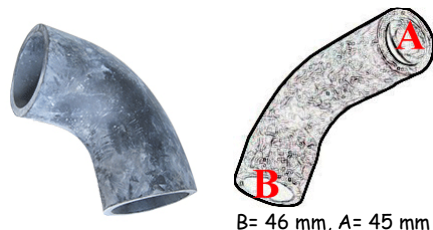

B= 46 mm, A= 45 mm

2108152 MANICOTT
O ASPIRANTE F45-65-
F2 /
SUCTION SLEEVE F45-
65-F2
200334:
COMENDA ALI SPA

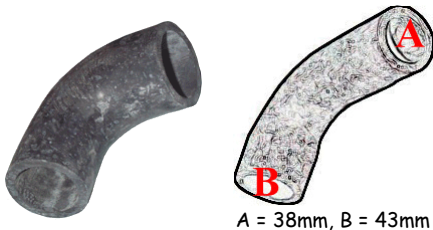

A = 38mm, B = 43mm

2108066 TUBO
ASPIRAZIONE POMPA
B15/16/1819T /
EXTRACTION HOSE
B15/16/1819T
200732:
COMENDA ALI SPA

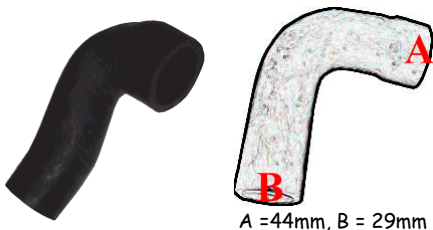

A = 44mm, B = 29mm

2108076 MANICOTT
O ASPIRAZIONE
POMPA LF400 /
PUMP SUCTION
SLEEVE LF400
200788:
COMENDA ALI SPA

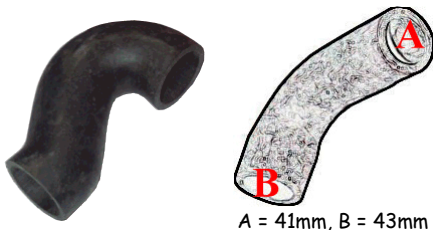

A = 41mm, B = 43mm

2108067 TUBO
MANDATA POMPA
B15 /
OUTLET HOSE FOR
B15 PUMP
200733:
COMENDA ALI SPA

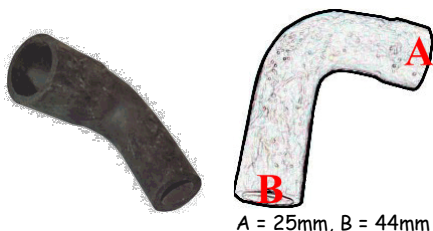

A = 25mm, B = 44mm

2108126 MANICOTT
O ASPIRAZIONE FC /
SUCTION SLEEVE FC
200787:
COMENDA ALI SPA

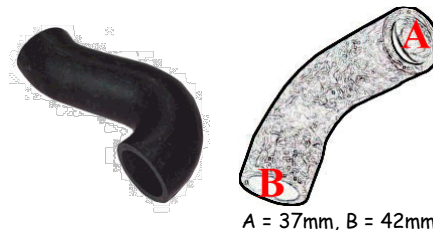

A = 37mm, B = 42mm

2108136 MANICOTT
O MANDATA POMPA
C 30 /
LOT PUMP SLEEVE
C30
200354:
COMENDA ALI SPA

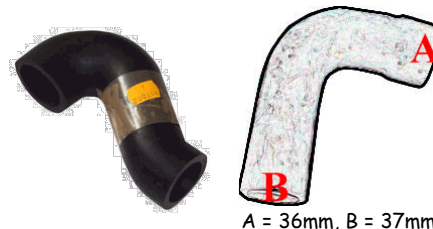

A = 36mm, B = 37mm

2108199 MANICOTT
O ASPIR. POMPA
LF2004 /
HOSE ASPIRATION
PUMP LF2004
200612:
COMENDA ALI SPA

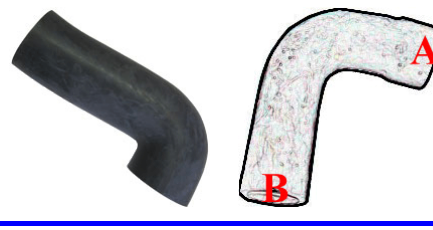

2108137 GOMITO
PREMENTE NE/LV/G60
/
OUTLET HOSE C34-35
200315:
COMENDA ALI SPA

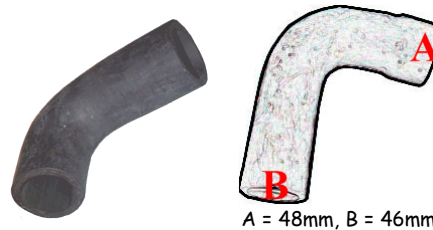

A = 48mm, B = 46mm

2108069 TUBO
MAND. POMPA B15-19
COLB. /
"OUTLET HOSE FOR
"B15-19" PUMP"
200781:
COMENDA ALI SPA

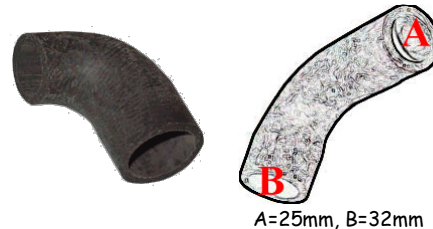

A=25mm, B=32mm

2108077 TUBO
ASPIRAZIONE POMPA
F90M/LF450 /
SUCTION HOSE PUMP
F90M / LF450
201014:
COMENDA ALI SPA

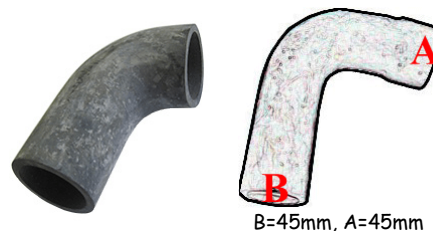

B=45mm, A=45mm

2108205 MANICOTT
O ASPIRAZIONE
POMPA /
PUMP SUCTION
SLEEVE
H29532:
COMENDA ALI SPA
29532:
HOONVED - ALI SPA

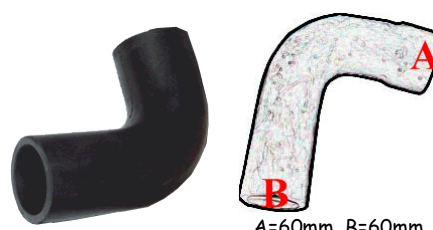

A=60mm, B=60mm

2108062 MANICOTT
O MANDATA POMPA
F45/LF350 /
"OUTLET HOSE FOR
""F45/LF350"" PUMP"
200389:
COMENDA ALI SPA

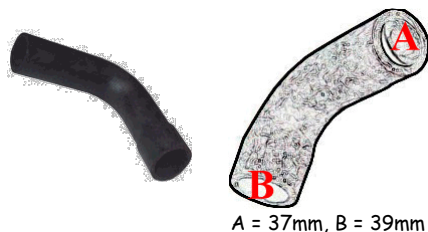

A = 37mm, B = 39mm

2108063 TUBO
ASPIRAZIONE C34-S
NUOVA L /
SUCTION SLEEVE C34-
S NUOVA L
200359:
COMENDA ALI SPA

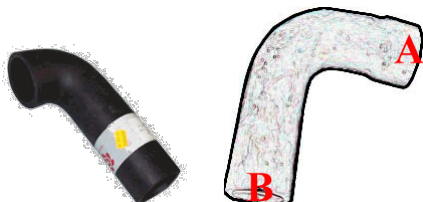

A = 61mm, B = 59mm

2108072 MANICOTT
O MAN. POMPA LAV.
C70/75 /
EXTRACTION HOSE
C70/75
201019:
COMENDA ALI SPA

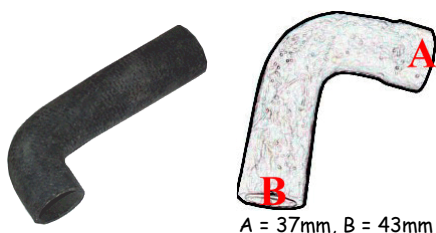

A = 37mm, B = 43mm

2108128 MANICOTT
O MANDATA POMPA
C70 75 /
LOT PUMP SLEEVE
C70 75
200755:
COMENDA ALI SPA



A = 41mm, B = 46mm

2108129 GOMITO
MANDATA
PREL.S2900/AC135 /
PREWASH LOT
ELBOW S2900/AC135
EX200311:
COMENDA ALI SPA
200753:
COMENDA ALI SPA

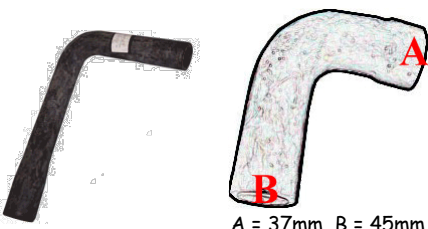

A = 37mm, B = 45mm

2108073 MANICOTT
O ASP. POMPA LAV.
C70/75 /
WASHING PUMP
SUCTION SLEEVE
C70/75
201020:
COMENDA ALI SPA
200724:
COMENDA ALI SPA

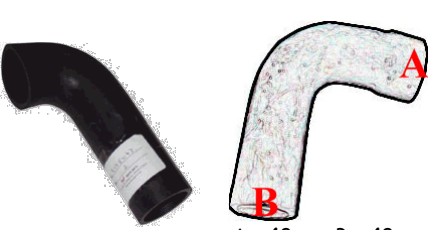

A = 43mm, B = 43mm

2108335 MANICOTT
O ASP.S3°-AC (200761)
/
SLEEVE FOR APS 53
200365:
COMENDA ALI SPA
200761:
COMENDA ALI SPA



B=47mm, A=58mm

2108074 TUBO
ASPIRAZIONE C85 /
EXTRACTION HOSE
200749:
COMENDA ALI SPA

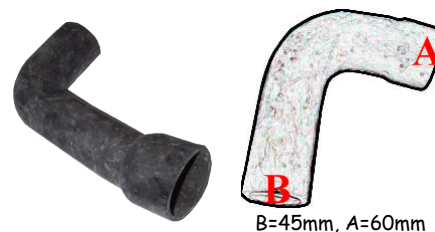

B=45mm, A=60mm

2108071 MANICOTT
O MANDATA POMPA
C30 /
LOT PUMP SLEEVE
C30
200725:
COMENDA ALI SPA

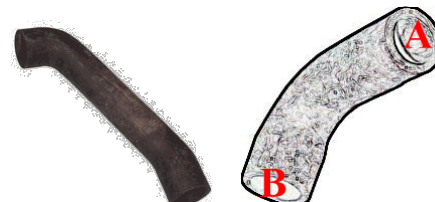

A = 39mm, B = 45mm

2108057 MANICOTT
O ASPIRAZIONE BR-
BC-FC /
SUCTION SLEEVE BR-
BC-FC
200778:
COMENDA ALI SPA

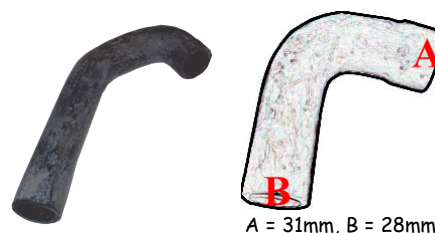

A = 31mm, B = 28mm

2108078 MANICOTT
O ASP. POMPA RISC.
LF/FC /
RINSE PUMP SUCTION
SLEEVE LF/FC
201017:
COMENDA ALI SPA

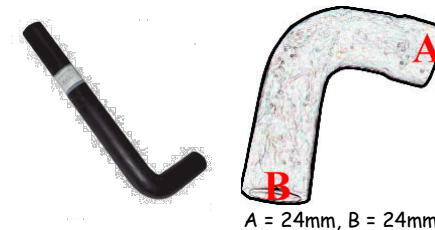

A = 24mm, B = 24mm

2108064 MANICOTT
O PER ECORINS SE/1 /
SLEEVE FOR ECORINS
SE/1
200759:
COMENDA ALI SPA

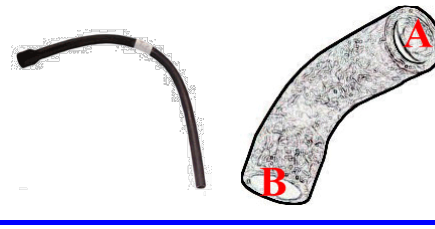

2108179 TUBO
LAVAGGIO FC53/F /
UPPER/
LOWER WASH HOSE
FC53
200791:
COMENDA ALI SPA

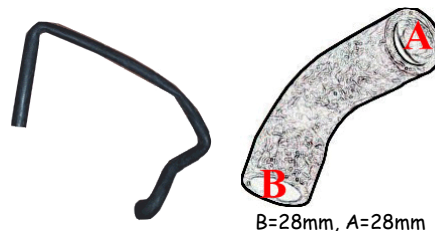

B=28mm, A=28mm

2108233 TUBO
LAVAGGIO
FC54/543/544 /
HOSE FOR
UPPER/LOWER WASH
FC54-544
200792:
COMENDA ALI SPA

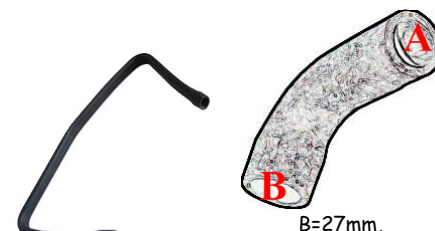

B=27mm,
DIMENSION=300X645
X300mm, A=27mm

2108401 MANICOTT
O LAVAGGIO F2-45-55-
65 /
WASHING HOSE F2-45-
55-65

200391:
COMENDA ALI SPA



B=29mm, A=28mm

2108391 MANICOTT
O COLLEGAMENTO
RISCIACQUO
LAVABICCHIERI ADD
/
HOSE CONNECTION
RINSE
GLASSWASHERS ADD

200740:
COMENDA ALI SPA

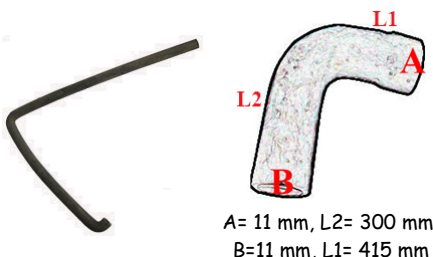

A= 11 mm, L2= 300 mm,
B=11 mm, L1= 415 mm

2108127 MANICOTT
O 3 VIE C95-155-165 /
3 WAYS SLEEVE C95-
155-165

200768:
COMENDA ALI SPA

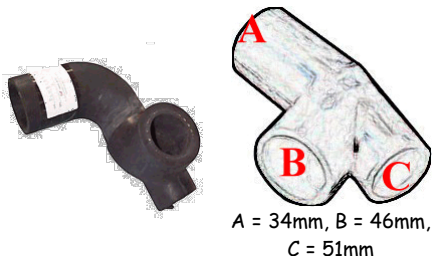

A = 34mm, B = 46mm,
C = 51mm

2108097 MANICOTT
O POMPA
DIAM.36X28X75
DERBY325 /
PUMP LOT SLEEVE D.
36X28X75 DERBY325

DW10718:
DIHR-ALI SPA
DW440718:
DIHR-ALI SPA
DW16083:
DIHR-ALI SPA



A=28mm , B=28mm

2108108 MANICOTT
O RONY FLEX 35.285 /
LOT SLEEVE RONY
FLEX 35.285

DW11600048:
DIHR-ALI SPA



2108093 MANICOTT
O ASPIRAZ. 95 GS100
DIAM. 60/60 /
SUCTION SLEEVE 95
GS100 DIAM. 60/60

DW25032:
DIHR-ALI SPA

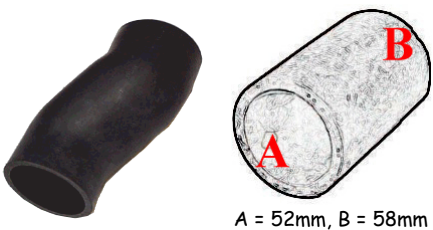

A = 52mm, B = 58mm

2108087 TUBO
EPDM ASPIRAZIONE
D.50/30 /
EXTRACTION HOSE
D.50/30

DW16170:
DIHR-ALI SPA



2108098 TUBO
EPDM
MAND.LAV.INF.LINEA
R LSG3 /
LOT SLEEVE EPDM
DISHWASHER LINEAR
LSG3

DW16168:
DIHR-ALI SPA



2108102 GOMITO
ASPIRAZIONE "S" /
"SUCTION LOT
SLEEVE ""S""

DW10200124A:
DIHR-ALI SPA

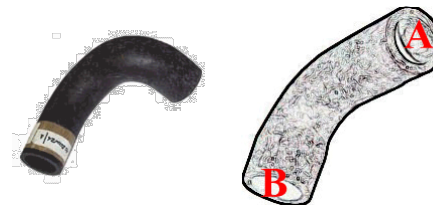

2108397 MANICOTT
O MANDATA A L 45/45
/
HOSE OUTLET PUMP
45/45

DW91106:
DIHR-ALI SPA

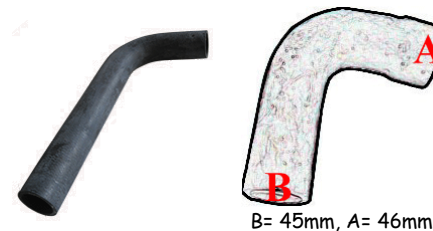

B= 45mm, A= 46mm

2108103 MANICOTT
O ASPIRAZIONE TIPO
1000 /
SUCTION LOT SLEEVE
TYPE 1000

DW22015:
DIHR-ALI SPA



B=59mm, A=51mm

2108326 MANICOTT
O 50/35 RINFORZATO /
SUCTION SLEEVE

DW16170M:
DIHR-ALI SPA



2108403 #TUBO
ASPIRAZIONE
PRESSOSTATO /
PRESSURE SWITCH
SUCTION PIPE

DW10600208:
DIHR-ALI SPA

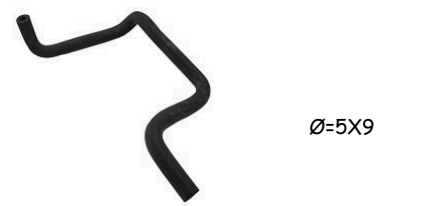

Ø5X9

2108114 TUBO
MANDATA
SUPERIORE TEK6
DIHR /
PRESSURE HOSE
UPPER TEK6 DIHR
DW560008:
DIHR-ALI SPA

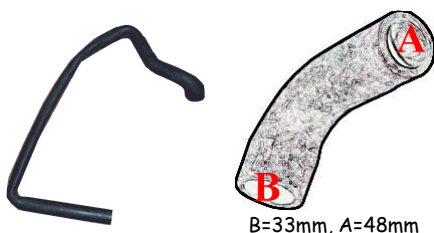

B=33mm, A=48mm

2108260 MANICOTT
O MANDATA G12/03 /
OUTLET HOSE G12/03
DW11600101:
DIHR-ALI SPA



A=38mm, B=37mm

2108285 TUBO
POMPA RISCIAQUO
BOILER /
BRAIDED HOSE
049599:
ELECTROLUX
PROFESSIONAL
S.P.A.



2108257 GOMITO IN
GOMMA DI
MANDATA /
LOT SLEEVE
DZG47EX:
ELETTROBAR
DIVISIONE DELLA
EUROTEC SRL
926034:
ELETTROBAR
DIVISIONE DELLA
EUROTEC SRL



B=48mm, a=48mm

2108277 GOMITO IN
GOMMA D40 100X100 /
SLEEVE D40 100X100
926032:
ELETTROBAR
DIVISIONE DELLA
EUROTEC SRL
*:
MBM- EUROTEC SRL
- DIV. COOKING
SERVICE

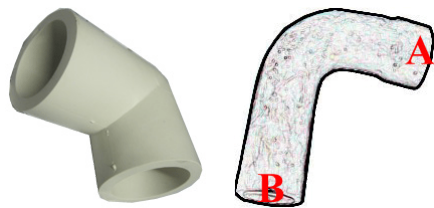

2108119 MANICOTT
O MANDATA S870 /
LOT SLEEVE S870
127021:
ELETTROBAR
DIVISIONE DELLA
EUROTEC SRL

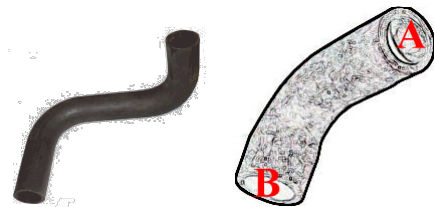

A = 49mm, B = 49mm

2108370 MANICOTT
O POMPA SCARICO /
HOSE DRAIN PUMP
H324867:
ELETTROBAR
DIVISIONE DELLA
EUROTEC SRL



2108372 MANICOTT
O ASPIRANTE LP70 /
HOSE SUCTION LP70
00065303:
ELFRAMO SPA



2108243 MANICOTT
O MANDATA /
FORMED HOSE
WAREWASHING L-
SHAPE
80188: ELETTROBAR



A=50mm, B=45mm

2108266 GOMITO IN
GOMMA P2703 SALAG /
EXTRACTION HOSE
P2703 SALAG
929164:
ELETTROBAR

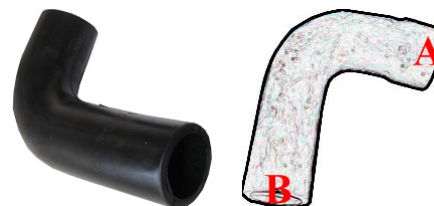

2108244 GOMITO IN
GOMMA DI
MANDATA PER
LAVASTOVIGLIE /
SLEEVE
927016:
ELETTROBAR
*:
MBM- EUROTEC SRL
- DIV. COOKING
SERVICE



2108310 MANICOTT
O MANDATA X
CONDOTTA PL.100/110
/
LOT SLEEVE
PL.100/110
926157:
ELETTROBAR
DIVISIONE DELLA
EUROTEC SRL



B=50mm, A=45mm

2108202 MANICOTT
O ASPIRAZIONE /
FORMED HOSE
80186:
ELETTROBAR
DIVISIONE DELLA
EUROTEC SRL
*:
MBM- EUROTEC SRL
- DIV. COOKING



SERVICE

2108293 TUBO DI
MANDATA GWX-2 /
FORMED HOSE
WAREWASHING
CONSTRUCTION
FORM L GWX-2

127001:

ELETTROBAR
DIVISIONE DELLA
EUROTEC SRL

*:

MBM- EUROTEC SRL
- DIV. COOKING
SERVICE



2108297 MANICOTT
O MANDATA POMPA
RIVER 82/83 /
FORMED HOSE
WAREWASHING L-
SHAPE

*:

MBM- EUROTEC SRL
- DIV. COOKING
SERVICE

80187:

ELETTROBAR
DIVISIONE DELLA
EUROTEC SRL

C80187: LOTUS SPA
C80187: COLGED

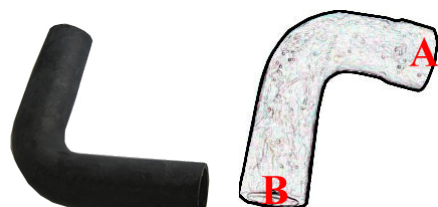

A=45mm, B=48mm

2108333 MANICOTT
O POMPA SCARICO
Q35 22 /
HOSE DRAIN PUMP
Q35 22

127033:

ELETTROBAR
DIVISIONE DELLA
EUROTEC SRL



2108317 MANICOTT
O P.S.- VALVOLA DI
SFIATO RV44 /
PUMP DRAIN HOSE-
BREATHER VALVE
RV44

127083:

ELETTROBAR
DIVISIONE DELLA
EUROTEC SRL

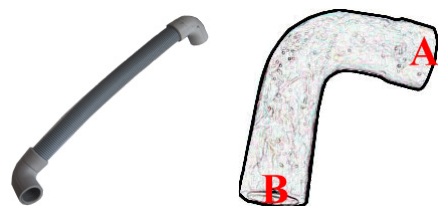

2108124 MANICOTT
O PREMENTE LG=100
D=50 /
SLEEVE LG=100
D.50MM

00004060:

ELFRAMO SPA

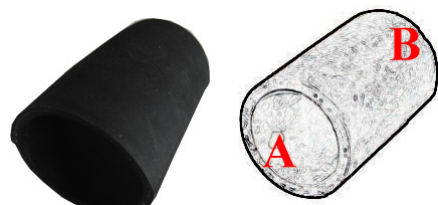

A=50mm, B=50mm

2108369 MANICOTT
O ASPIRANTE D30 /
HOSE SUCTION D30
D30: ELFRAMO SPA

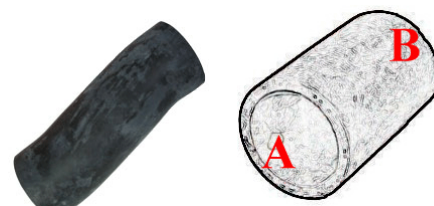

B=50mm, A=50mm

2108006 MANICOTT
O PREMENTE BD14
ELFRAMO /
PUMP OUTLET HOSE

00222108:

ELFRAMO SPA



A= 27 mm B= 55 mm

2108153 MANICOTT
O ASPIRANTE 600
ELFRAMO /
SUCTION SLEEVE 600
ELFRAMO

00004110:

ELFRAMO SPA



A = 85mm, B = 70mm

2108203 MANICOTT
O PREMENTE
MR1200/912 /
SLEEVE MR1200/912

00004070:

ELFRAMO SPA



2108270 MANICOTT
O PREMENTE MRS400
/
PRESSURE HOSE
MRS400

00004050:

ELFRAMO SPA

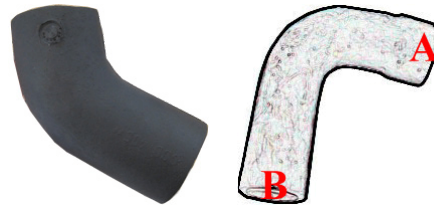

2108271 MANICOTT
O ASPIRANTE SQ
160/240 /
EXTRACTION HOSE
SQ 160/240

00010530:

ELFRAMO SPA

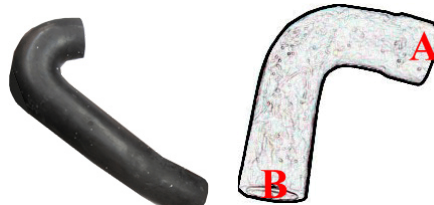

A=70mm, B=64mm

2108022 MANICOTT
O ASPIRANTE 1200 /
EXTRACTION HOSE
1200

00004120:

ELFRAMO SPA



2108365 MANICOTT
O ASPIRANTE LP
RICAMBI /
SUCTION HOSE LP
00052900ex:
ELFRAMO SPA

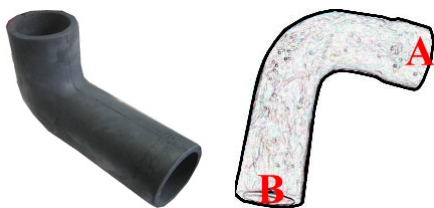

2108188 MANICOTT
O ASPIRANTE C44 /
SUCTION SLEEVE C44
00018312:
ELFRAMO SPA

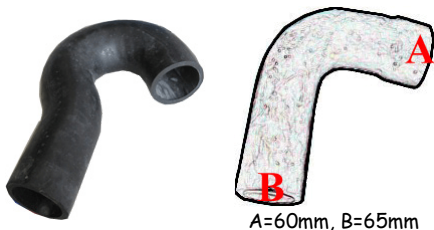

2108332 MANICOTT
O ASPIRANTE C34 /
SUCTION SLEEVE C34
00019136:
ELFRAMO SPA



2108340 MANICOTT
O ASPIRANTE ETE
PART /
SUCTION SLEEVE ETE
00079645: ELFRAMO
SPA



2108250 COLONNA
LAVAGGIO D30 /
WASH PIPE D30
00011858:
ELFRAMO SPA
00014286:
ELFRAMO SPA

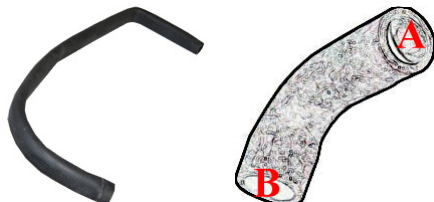

2108238 MANICOTT
O MANDATA NP43-49 /
LOT SLEEVE NP43-49
984029000:
GRUPPO CIMBALI
SPA
9121004:
GRUPPO CIMBALI
SPA

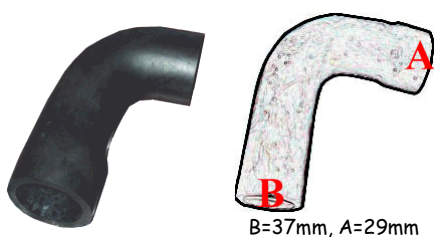

2108239 MANICOTT
O ASPIRAZIONE P43E-
NP43* /
ASPIRATION HOSE
P43E-NP 43 *
984030000:
GRUPPO CIMBALI
SPA
9121011:
GRUPPO CIMBALI
SPA



2108201 MANICOTT
O ASPIRAZIONE P 80-
120 /
SUCTION SLEEVE P
80-120
9121204:
GRUPPO CIMBALI
SPA



2108400 MANICOTT
O SCARICO NP 60 /
HOSE DRAIN NP 60
977003000:
GRUPPO CIMBALI
SPA



2108209 MANICOTT
O SCARICO NP 43-49* /
EXHAUST SLEEVE NP
43-49
9121008:
GRUPPO CIMBALI
SPA

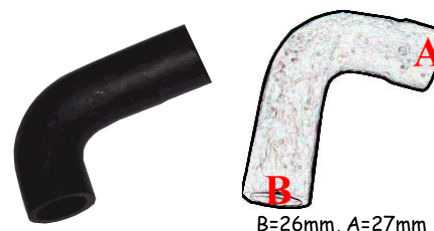

2108235 MANICOTT
O X
MAND.RACCORDO 90°
/
PRESSURE HOSE 90°
32055:
HOONVED - ALI SPA

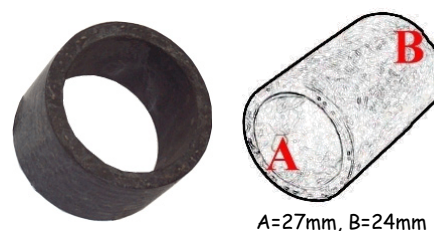

2108264 MANICOTT
O PREMENTE ED 650 /
PRESSURE HOSE ED
650
33455:
HOONVED - ALI SPA

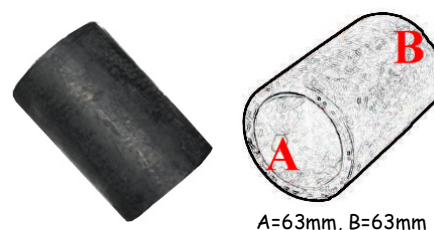

2108141 MANICOTT
O ASPIRAZ. E50 APS 43
/
EXTRACTION HOSE
E50 APS 43
26909:
HOONVED - ALI SPA

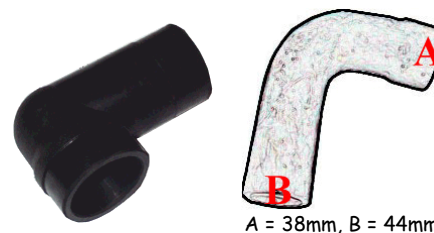

2108236 MANICOTT
O SCARICO A GOMITO
/
EXHAUST SLEEVE
31612ex: HOONVED
201033: HOONVED
201033: HOONVED



2108143 MANICOTT
O ASPIRAZIONE CM 48
/
SUCTION SLEEVE CM
48
26907:
HOONVED - ALI SPA

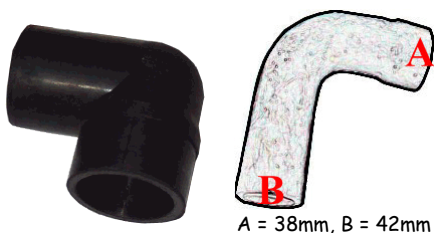

A = 38mm, B = 42mm

2108212 MANICOTT
O DI MANDATA T3-T4
/
LOT SLEEVE T3-T4
28421:
HOONVED - ALI SPA



B=45mm, A=38mm

2108033 MANICOTT
O DI MANDATA 42 /
SLEEVE HOONVED 42
25221:
HOONVED - ALI SPA



A=42mm, B=28mm

2108405 MANICOTT
O ASPIRAZIONE C
43/C 46 E /
SUCTION SLEEVE C
43/C 46 E
36814:
HOONVED - ALI SPA

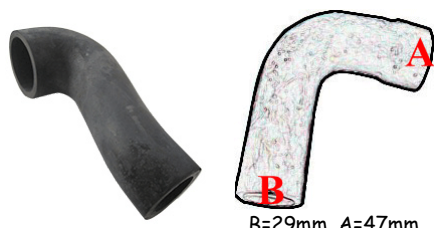

B=29mm, A=47mm

2108155 MANICOTT
O MANDATA C3-4
HNVD /
LOT SLEEVE C3-4
HOONVED
32881:
HOONVED - ALI SPA

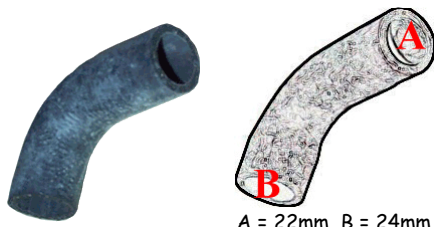

A = 22mm, B = 24mm

2108206 MANICOTT
O MANDATA A 90°ED
700 /
LOT SLEEVE 90° ED
700
31788:
HOONVED - ALI SPA



A=60mm, B=57mm

2110140 TUBO
GOMMA BOILER/TEE
AIR GAP /
BOILER RUBBER
PIPE/TEE AIR GAP
36028:
HOONVED - ALI SPA
201070:
COMENDA ALI SPA



2108288 MANICOTT
O MANDATA ED 600 /
LOT SLEEVE ED 600
32984:
HOONVED - ALI SPA
H32984:
COMENDA ALI SPA

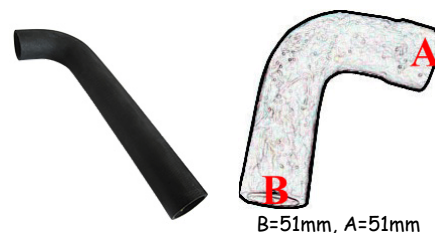

B=51mm, A=51mm

2108292 MANICOTT
O MANDATA S/E 50 /
LOT SLEEVE S/E 50
27010:
HOONVED - ALI SPA



2108220 MANICOTT
O ASPIRAZ.S/E 52 /
SUCTION SLEEVE.S/E
52
26908:
HOONVED - ALI SPA



A = 78mm, B = 78mm

2108256 TUBO
ASPIRAZIONE
C140/C110 /
INTAKE HOSE
C140/C110
33454:
HOONVED - ALI SPA

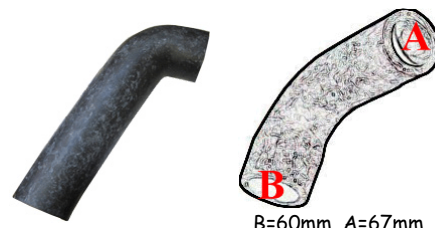

B=60mm, A=67mm

2108262 MANICOTT
O DI MANDATA /
PRESSURE HOSE
25227:
HOONVED - ALI SPA



2108234 MANICOTT
O MANDATA APS
43/48 / LOT SLEEVE
APS 43/48
33816: HOONVED -
ALI SPA

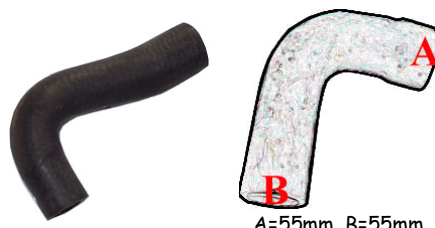

A=55mm, B=55mm

2108252 MANICOTT
O MANDATA C 81/C 90
/
LOT SLEEVE C 81/C 90
35020:
HOONVED - ALI SPA



A=52mm, B=50mm

2108286 MANICOTT
O MAND.LAV. 53/60 /
FORMED HOSE
WAREWASHING
CONSTRUCTION
FORM U 53/60
33583:
HOONVED - ALI SPA

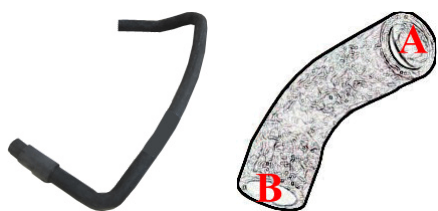

2108208 MANICOTT
O ASPIRAZIONE
LAVATAZ. / SUCTION
SLEEVE
L3100: LUXIA SRL



2108384 MANICOTT
O 32 RACCORDO
INFERIORE 1 PEZZO
0,12 MT /
HOSES 32 FITTING
LOWER
600705EX:
KRUPPS S.R.L.
103543:
KRUPPS S.R.L.

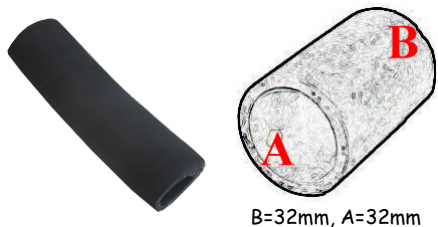

B=32mm, A=32mm

2108198 MANICOTT
O MANDATA 3VIE
LAVAP. /
LOT SLEEVE 3 WAYS
L3104: LUXIA SRL



C = 38mm, A = 24mm, B = 37mm

2108385 MANICOTT
O 50 RACCORDO
INFERIORE /
HOSES 50 FITTING
LOWER
800706:
KRUPPS S.R.L.

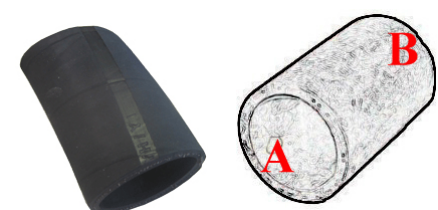

B=50mm, A=50mm

2108004 MANICOTT
O MANDATA 1T IME /
LOT SLEEVE 1T IME
JOLLY,UNO
T,UNO_T:
OMNIWASH SRL -
SOCIETA' A SOCIO
UNICO

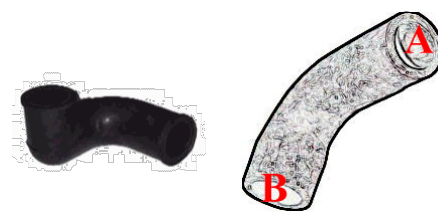

A = 28mm, B = 28mm

2108258 "MANICOT
TO Ø32 MM
RACCORDO A "L" /
SLEEVE Ø32 MM
207705:
KRUPPS S.R.L.



A=38mm, B=37mm

2108024 MANICOTT
O ASPIRAZIONE
JOLLY /
SUCTION SLEEVE
JOLLY
6A18:
OMNIWASH SRL -
SOCIETA' A SOCIO
UNICO

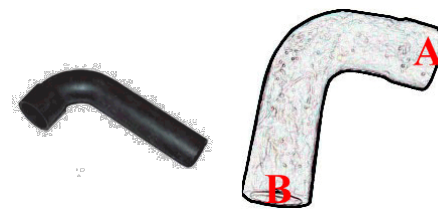

A = 28mm, B = 34mm

2108381 MANICOTT
O MANDATA IN
GOMMA Ø50x60 /
LOT SLEEVE Ø50x60
1200705:
KRUPPS S.R.L.

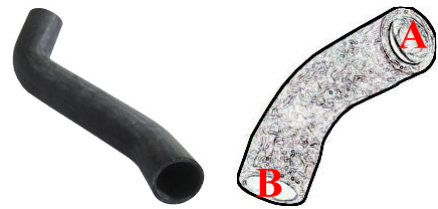

2108003 MANICOTT
O SCARICO 1 IME /
EXHAUST SLEEVE 1
IME
JOLLY,UNO:
OMNIWASH SRL -
SOCIETA' A SOCIO
UNICO

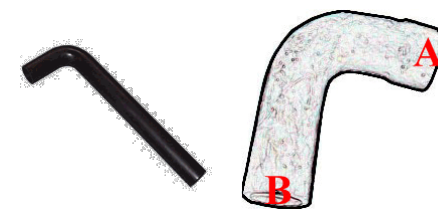

A = 26mm, B = 26mm

2108196 RACCORDO
MANDATA POMPA
LC5 /
LOT SLEEVE FOR
PUMP LC5
2703170: LASA SRL

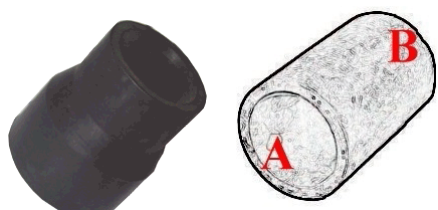

A = 39mm, B = 48mm

2108009 TUBO
MANDATA
RISCIACQUO 4/82 /
LOT SLEEVE RINSE
4/82
6B5MRC:
OMNIWASH SRL -
SOCIETA' A SOCIO
UNICO



B=10mm, A=10mm

2108184 TUBO
DERIVAZIONE 50-6 /
LOT SLEEVE 50-6
2703130:
LASA SRL

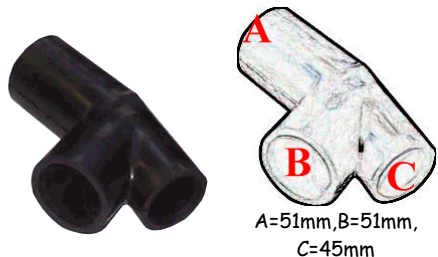

A=51mm, B=51mm,
C=45mm

2108357 MANICOTT
O MANDATA INF. 4SA
(M.P.I.) /
DELIVERY HOSE INF.
4SA (M.P.I.)
LI4SAINF:
OMNIWASH SRL -
SOCIETA' A SOCIO
UNICO



B=38mm, A=36mm

2108172 MANICOTT
O SCARICO MOD 2 /
DRAIN HOSE MOD 2
GS220:
OMNIWASH SRL -
SOCIETA' A SOCIO
UNICO

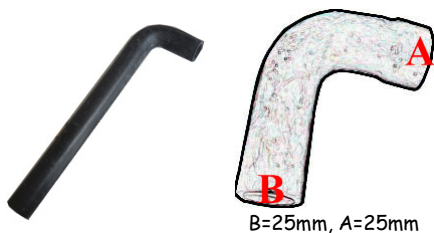

B=25mm, A=25mm

2108174 MANICOTT
O SCARICO VASCA /
HOSE DRAIN TANK
GS520:
OMNIWASH SRL -
SOCIETA' A SOCIO
UNICO

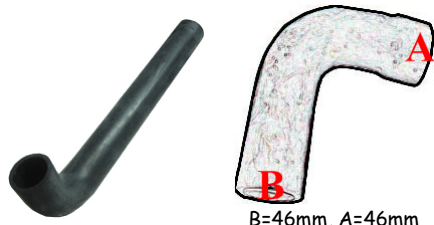

B=46mm, A=46mm

2108175 MANICOTT
O ASPIRAZIONE 4/82 /
FORMED HOSE
WAREWASHING L-
SHAPE 4/82
GA538:
OMNIWASH SRL -
SOCIETA' A SOCIO
UNICO



B=42mm, A=42mm

2108254 MANICOTT
O ASPIRAZIONE 4SA-
62P (VS.COD. 2435) /
ASPIRATION HOSE
4SA-62P
GASAB:
OMNIWASH SRL -
SOCIETA' A SOCIO
UNICO

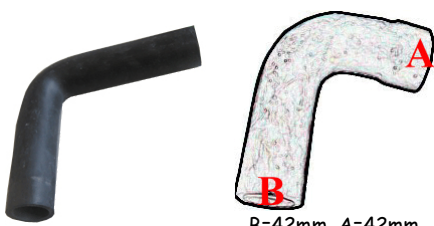

B=42mm, A=42mm

2108222 MANICOTT
O MANDATA MOD.
4/82 CT /
LOT SLEEVE MOD.
4/82 CT
GL4T22:
OMNIWASH SRL -
SOCIETA' A SOCIO
UNICO

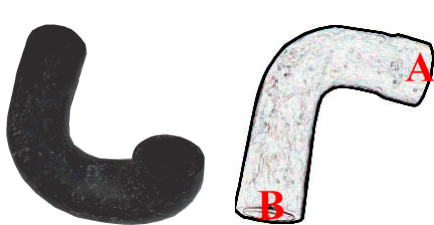

2108255 MANICOTT
O MANDATA 62P /
HOSE FLOW 62P
LI6312:
OMNIWASH SRL -
SOCIETA' A SOCIO
UNICO



B=28mm, A=38mm

2108361 MANIC.MA
ND.POMPA LS385 /
HOSE DELIVERY
PUMP LS38
36306007:
RANCILIO SPA



2108213 MANIC.MA
ND.POMPA LS605-GM /
LOT SLEEVE LS605-
GM
36306008:
RANCILIO SPA



2108080 MANICOTT
O ASPIRAZIONE
POMPA LT105 /
PUMP INLET HOSE
LT105
36306020:
RANCILIO SPA

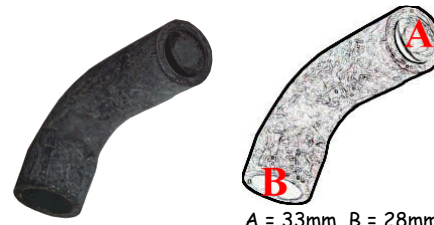

A = 33mm, B = 28mm

2108216 MANICOTT
O MANDATA N45-N50
VT /
LOT SLEEVE N45-N50
VT
903752:
SILANOS SRL



2108149 MANICOTT
O MANDATA E 40 V 40
/
LOT SLEEVE E 40 V 40
903667:
SILANOS SRL

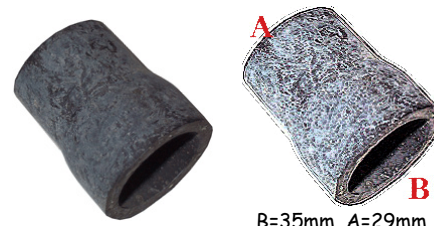

B=35mm, A=29mm

2108321 GOMITO
90° INOX
ASPIRAZ.LAVAGGIO
T-N-LP /
ELBOW WASH PIPE
90°
TR0715:
SILANOS SRL

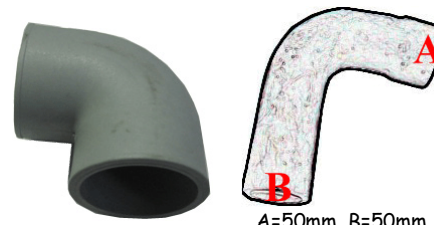

A=50mm, B=50mm

2108147 MANICOTT
O MANDATA P C B A
96 /
OUTLET HOSE
903668:
SILANOS SRL



B= 30 mm, A= 37 mm

2108148 MANICOTT
O ASPIRAZIONE E40
V40 C400 96 /
EXTRACTION HOSE
E40 V40 C400 96
903666:
SILANOS SRL

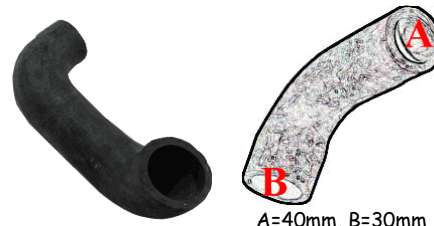

A=40mm, B=30mm

2108150 MANICOTT
O MANDATA
INFERIORE LC80 /
LOWER OUTLET HOSE
LC80
903680:
SILANOS SRL



B=40mm, A=40mm

2108151 MANICOTT
O ASPIRAZIONE 1000 /
SUCTION SLEEVE 1000
903701:
SILANOS SRL



A = 51mm, B = 57mm

2108010 MANICOTT
O ASPIRAZIONE R20 /
SUCTION SLEEVE R20
SVELTINA_024, 030,
R_,F_:
SILANOS SRL

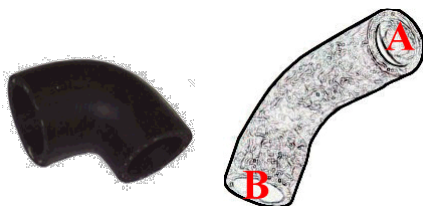

A = 34mm, B = 27mm

2108028 MANICOTT
O ASPIRAZIONE
600/700 /
SUCTION SLEEVE
600/700
600,700:
SILANOS SRL
903758:
SILANOS SRL

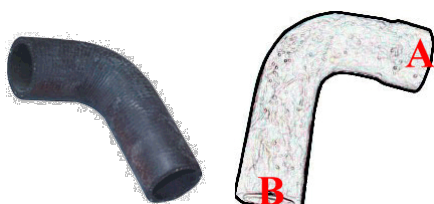

A = 45mm, B = 45mm

2108377 MANICOTT
O MANDATA
SUPERIORE N27-V40 /
LOT UPPER HOSE N27-
V40
903725:
SILANOS SRL



B=29mm, A=29mm

2108312 MANICOTT
O ASPIRAZIONE
POMPA Ø 50 /
SUCTION SLEEVE
PUMP Ø 50
3360:
UNIVER-BAR SRL



B=50mm, A=50mm

2108029 MANICOTT
O DI MANDATA 700 /
LOT SLEEVE 700
600,700:
SILANOS SRL



A = 42mm, B = 42mm

2108044 MANICOTT
O MANDATA 1300 /
FORMED HOSE
WAREWASHING L-
SHAPE 1300
903761:
SILANOS SRL
908713:
SILANOS SRL

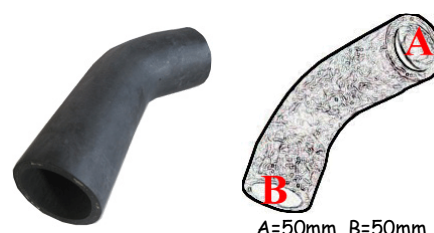

A=50mm, B=50mm

2108214 MANICOTT
O MANDATA SUP. 700-
800-900 /
LOT SLEEVE 700-800-
900
903726:
SILANOS SRL



A = 28mm, B = 28mm

2108246 MANICOTT
O GOMMA VASCA -
MOTORE /
LOT SLEEVE
120470:
SISTEMA PROJECT
SERVICE SRL



2108351 MANICOTT
O /
SLEEVE
833117:
TEIKOS SRL



2108350 MANICOTT
O /
SLEEVE
833113:
TEIKOS SRL



2108276 GOMMINO
PER FILTRO VASCA /
TANK FILTER
GASKET
4746:
UNIVER-BAR SRL



B=57mm, A=57mm

4120236 TUBO
RADIATORE /
COOLER HOSE
1591:
UNIVER-BAR SRL



2108304 MANICOTT
O RIDOTTO /
REDUCED SLEEVE
3356:
UNIVER-BAR SRL

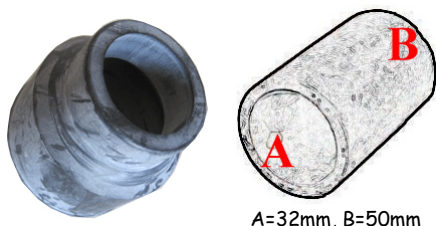

A=32mm, B=50mm

2108301 MANICOTT
O ASPIRAZIONE
COSMO/COMPACT /
SUCTION SLEEVE
COSMO/COMPACT
4574:
UNIVER-BAR SRL



A=51mm, B=57mm

2108302 MANICOTT
O ASPIRAZIONE
POMPA ERGON /
SUCTION SLEEVE
PUMP ERGON
4319:
UNIVER-BAR SRL

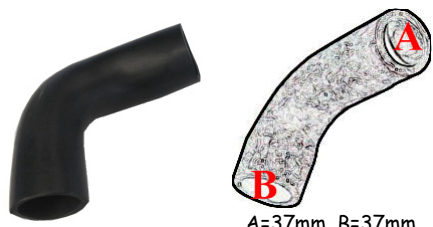

A=37mm, B=37mm

2108327 MANICOTT
O MANDATA
LAVAGGIO
INFERIORE
LAVAPIATTI /
DISCHARGE HOSE
LOWER DISHWASHER
3361:
UNIVER-BAR SRL



A=29mm, B=32mm

3112381 GRUPPO
LAVAGGIO /

WASHING ROD
049945:
ELECTROLUX
PROFESSIONAL
S.P.A.



2108320 CONDOTTA
LAVAGGIO SALDATA
RIVER 50 /
WASH TUBE
COMPLET RIVER 50
115128ex:
ELETTROBAR
DIVISIONE DELLA
EUROTEC SRL
115139:
ELETTROBAR
DIVISIONE DELLA
EUROTEC SRL



2108217 CONDOTTA
LAVAGGIO. EST. PL.
CPL X5 (1 FORO) /
PIPE CLEANING EST.
PL. CPL X5 (1 HOLE
115121:

ELETTROBAR
DIVISIONE DELLA
EUROTEC SRL
*:

MBM- EUROTEC SRL
- DIV. COOKING
SERVICE



Ø Piccolo= 11mm, Ø
Grande= 31mm, Ø
Tubetto= 7X4

2108366 MANDATA
LAVAGGIO
COMPLETA FRONTALI
/
FLOW WASH
COMPLETE FRONTAL
35400:
ELETTROBAR



Ø MANICOTTO=32mm

3112426 CONDOTTA
LAV. EST. CPL. E50-503
BRACCIPI. /
WASHING ARM CPL.
E50-503
115131:

ELETTROBAR
DIVISIONE DELLA
EUROTEC SRL



4115940 CONDOTTA
LAV. EST. PL. + MANIC. +
115111 SP405 /
WASH PIPE
COMPLETE
115113:
ELETTROBAR



2108218 MANDATA
LAVAGGIO GOLD
COMPLETA /
WASH PIPE
COMPLETE
*:

MBM- EUROTEC SRL
- DIV. COOKING
SERVICE
80237:
ELETTROBAR



= 3112317, = 4120201

2108379 TUBO
ALIMENTAZIONE
LAVAGGIO 3VIE
AP43/48E /
TUBE FEEDING
WASHING 3WAY AP43
/ 48E
37630: HOONVED



2108242 MANICOTT
O MAND.LAV. C 6 /
LOT SLEEVE C 6
35550:
HOONVED - ALI SPA

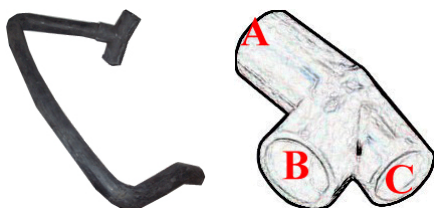

2108354 ASS. TUBO
MANDATA /
DELIVERY PIPE
ASSEMBLY
41217300 :
MODULAR SPA



2108183 MANICOTT
O MAND. INF-SUP
MOD. 4Q/82 /
FORMED HOSE MOD.
4Q/82
GLMSIC4:
OMNIWASH SRL -
SOCIETA' A SOCIO
UNICO
GLMSIC404:
OMNIWASH SRL -
SOCIETA' A SOCIO
UNICO

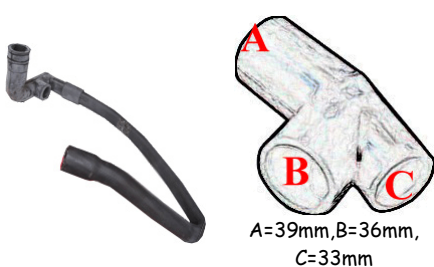

A=39mm, B=36mm,
C=33mm

2108353 MANICOTT
O MAND. INF-SUP
MOD. 4SB (/ /
LOT SLEEVE MOD.
4SB
GLMSIC4SB:
OMNIWASH SRL -

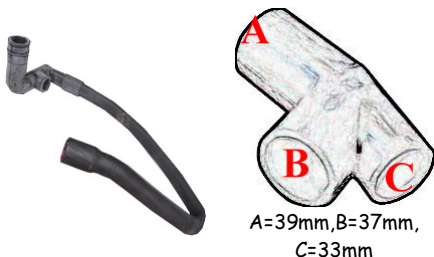

A=39mm, B=37mm,
C=33mm

2108176 MANICOTT
O MANDATA
INFERIORE-
SUPERIORE 1Q /
HOSES SUPPLY LESS-
THAN 1Q
GLMSIC104:
OMNIWASH SRL

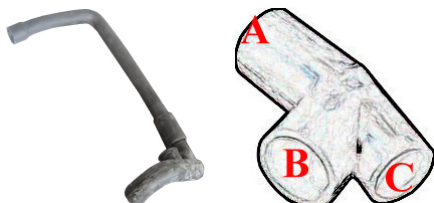

2108194 TUBETTO
TENUTA GABBIA
D'ARIA DIS.964 /
PIPE PIECE
2933:
ARISTARCO SPA

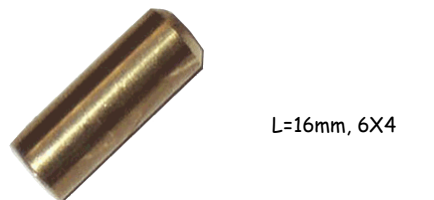

L=16mm, 6X4

2108251 RACCORDO
COLONNA D30 /
SUPPLY PIPE
CONNECTION FOR
D30
00011264:
ELFRAMO SPA



2108281 MANICOTT
O INOX Ø 33X110 /
STAINLESS STEEL
HOSE ? 35X110
3339:
UNIVER-BAR SRL



2108303 MANICOTT
O INOX Ø 35X78 /
INOX SLEEVE Ø
35X78
3720:
UNIVER-BAR SRL

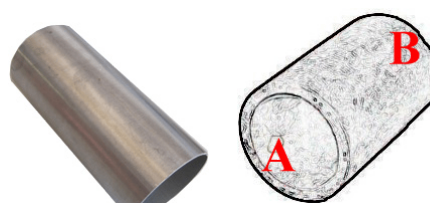

A=33mm, B=33mm

2108131 GOMITO /
ELBOW
280101:
COMENDA ALI SPA



Ø=19mm

2108269 GOMITO
PORTAGOMMA
LAVASTOVIGLIE
FRONTALE /
"HOSE CONNECTOR
ELBOW ?"" "
108006:ELETTROBAR
*: MBM
S58: ELETTROBAR



Ø=13mm

2108139 MANICOTT
O RAC. ELET-MISC.43 /
SLEEVE 43
29618:
HOONVED - ALI SPA



2108085 MANICOTT
O INF.GS100 L=122MM
P646 /
SLEEVE GS100
L=122MM P646
DW550223ex:
DIHR-ALI SPA
DW550225:
DIHR-ALI SPA



B=50mm, A=34mm

2108125 PORTAGO
MMA A T D 115 /
TEE NIPPLE D.11,5 -
RINSE ASSEMBLY
180413:
HOONVED - ALI SPA
180413:
COMENDA ALI SPA
33276ex:
HOONVED - ALI SPA
1056: A.T.A. SRL
33Q4450:
ANGELO PO GRANDI



CUCINE SPA

2108130 TUBO
PL.D.9,5 (3/8)-C15 /
PIPE PL.D.9,5 (3/8)-C15
160115:
COMENDA ALI SPA



2108181 GOMITO DI
SCARICO /
DRAIN ELBOW
DW10701:
DIHR-ALI SPA

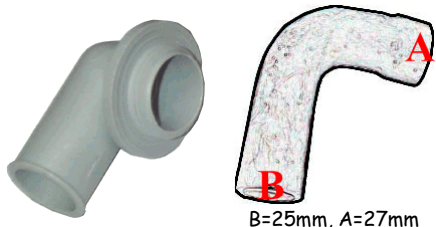

B=25mm, A=27mm

2108193 TRONCHET
TO ASPIRAZIONE
D.120MM /
SUCTION BODY
D.193MM
160603:
COMENDA ALI SPA



Ø=45mm

3126135 FILTRO
INOX X
LAVASTOVIGLIE PER
LAVAPIATTI /
STAINLESS STEEL
FILTER FOR X
DISHWASHER
PASSPORT
50,32/45.30/50.35/55
.40,PROJET 28,
GL432/1040/1240:
ARISTARCO KASTEL
SPA
*:
ARISTARCO KASTEL
SPA
4721:
ARISTARCO KASTEL
SPA



3126363 FILTRO
POMPA PASSPORT
A35-A38-A40 /
FILTER PUMP
PASSPORT A35-A38-
A40
3113:
ARISTARCO KASTEL
SPA



3126346 MICROFILT
RO PER C ANNO 2001 /
MICROFILTER FOR C
YEAR 2001
332068:
COMENDA ALI SPA



3126185 MICROFILT
RO LF 2004 /
MICROFILTER LF 2004
333006:
COMENDA ALI SPA



3126080 FILTRO
ASPIR.POMPA C,
TONDO COMENDA /
ROUND PUMP
SUCTION FILTER
COMENDA
332002:
COMENDA ALI SPA



3126057 FILTRO ASP.
POMPA C-CR-43-48 /
PUMP SUCTION
FILTER C-CR-43-48
332029:
COMENDA ALI SPA
34557:
HOONVED - ALI SPA



SPRING=1117292

3126091 FILTRO PER
CORPO SUPERIORE D.
42 /
ABOVE BODY FILTER
D. 42
DW540002:
DIHR-ALI SPA

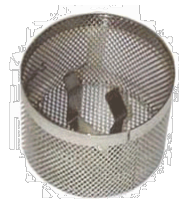

3126088 FILTRO
POMPA COMPLETA /
PUMP FILTER
DW10914:
DIHR-ALI SPA



3126541 FILTRO
POMPA LAVAGGIO
LP60 /
WASH PUMP FILTER
00065570:
ELFRAMO SPA

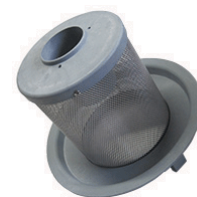

3126140 FILTRO
ACC.INX.P 60 E /
STAINLESS STEEL
FILTER MOD. 60 E
9131112:
GRUPPO CIMBALI
SPA
977500000:
GRUPPO CIMBALI SPA



3126141 FILTRO
ACC. INOX. MOD.NP
80-P 100 /
STAINLESS STEEL
FILTER MOD. NP 80-P
100

9131208:

GRUPPO CIMBALI SPA



3126139 FILTRO
ACC. INOX. MOD. SAP /
STAINLESS STEEL
FILTER MOD. SAP

9131002:

GRUPPO CIMBALI SPA

986510000:

GRUPPO CIMBALI
SPA



3126128 FILTRO
ASPIRAZIONE
MICRORETE HNVD /
SUCTION FILTER
HNVD

21094:

HOONVED - ALI SPA



3126048 FILTRO D.
185 SNL C140 /
FILTER D.185 SNL C140

33459:

HOONVED - ALI SPA



3124216 GHIERA
FILTRO ASPIRAZIONE
POMPA /
RING NUT SUCTION
FILTER PUMP

35994:

HOONVED - ALI SPA



3126147 MICROFILTO
RO ASPIRAZIONE
POMPA C43 /
INTAKE FILTER C43

34556:

HOONVED - ALI SPA



3126338 FILTRO ASP.
POMPA SCARICO INOX
DIAM.59 H51mm /
SUCTION FILTER
DRAIN PUMP
STAINLESS STEEL

GAFAPS199:

OMNIWASH SRL -
SOCIETA' A SOCIO
UNICO



3126025 FILTRO
ASPIRAZIONE POMPA
D. 77 /
FILTER D. 77

15800091:

RANCILIO SPA



3126114 FILTRO
ASPIRAZIONE INOX /
STAINLESS STEEL
SUCTION FILTER

902570: SILANOS

SRL

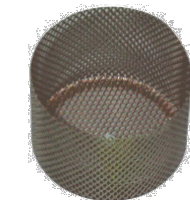

3126029 FILTRO
ASPIRAZIONE
DERLING E/V /
SUCTION FILTER
DERLING E/V

905395: SILANOS

SRL

904468: SILANOS

SRL



3126115 FILTRO
ASPIRAZIONE
GRANDE INOX /
STAINLESS STEEL
FILTER

902580: SILANOS

SRL



3126232 RETE
FILTRO Ø 195 /
FILTER Ø 195

3753:

UNIVER-BAR SRL



4120057 RETE
FILTRO Ø 98 /
FILTER Ø 98

4157: UNIVER-BAR

SRL



3126352 Filtro
aspirazione pompa
completo Ø 98 /
Complete filter suction
pump Ø 98

4156:

UNIVER-BAR SRL



3126193 FILTRO
ASPIRAZIONE D.82
AC94 /
FILTER D.82 AC94

180816:
COMENDA ALI SPA



3126056 FILTRO
ASPIRAZIONE
POMPA BC25 /
PUMP SUCTION
FILTER ABC25

180817:
COMENDA ALI SPA

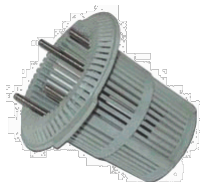

3126084 FILTRO
INTERNO VASCHETTA
TEKNO /
INTERNAL FILTER FOR
TANK TEKNO

DW500620:
DIHR-ALI SPA

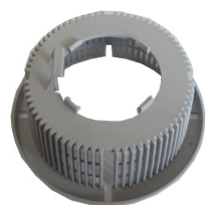

3126275 FILTRO
INTERNO CON
CESTELLO 2004 /
FILTER

DW500600:
DIHR-ALI SPA



3126083 FILTRO
ASPIRAZIONE GS 50 /
SUCTION FILTER GS
50

DW500616:
DIHR-ALI SPA



3126351 FILTRO
ASPIRAZIONE POMPA
RL/09 /
SUCTION FILTER
PUMP RL/09

DW25003:
DIHR-ALI SPA



3126362 FILTRO
VASCA /
FILTER TANK

0HA068:
ELECTROLUX
PROFESSIONAL
S.P.A.
11404: ADLER S.P.A.



3126145 FILTRO
ASPIRAZIONE POMPA
LAVABICCHIERI /
PUMP SUCTION
FILTER

121144:
ELETTROBAR
DIVISIONE DELLA



EUROTEC SRL
121118EX:
ELETTROBAR
DIVISIONE DELLA
EUROTEC SRL
121100ex:
ELETTROBAR
DIVISIONE DELLA
EUROTEC SRL
65121118:
RANCILIO SPA

3126153 FILTRO EST.
GRIGIO 21/31 /
EXTERNAL FILTER
21/31

121014:
ELETTROBAR
DIVISIONE DELLA
EUROTEC SRL

*:
MBM- EUROTEC SRL -
DIV. COOKING
SERVICE
069528:
ELECTROLUX
PROFESSIONAL
S.P.A.



3126154 FILTRO INT.
GRIGIO 21/31 /
INTERNAL FILTER
21/31

121016:
ELETTROBAR
DIVISIONE DELLA
EUROTEC SRL

*:
MBM- EUROTEC SRL -
DIV. COOKING
SERVICE
069529:
ELECTROLUX
PROFESSIONAL
S.P.A.

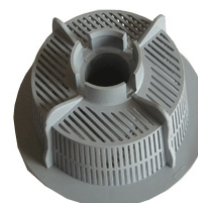

3126151 FILTRO
D'ASPIRAZIONE
POMPA E51 /
PUMP SUCTION
FILTER E51

121052:
ELETTROBAR
DIVISIONE DELLA
EUROTEC SRL

121081:
ELETTROBAR
DIVISIONE DELLA
EUROTEC SRL
DAF136U: COLGED



3126315 FILTRO
BASE COMPLETO LA50

/
FILTER BASE
COMPLETE LA50

121120:

ELETTROBAR
DIVISIONE DELLA
EUROTEC SRL



3126317 FILTRO
ASPIRAZ. POMPA
PLASTICA 11/353/.../
ROUND FILTERS
SUCTION/OUTFLOW

121076:

ELETTROBAR
DIVISIONE DELLA
EUROTEC SRL



3126195 FILTRO
POMPA LAVAGGIO
MRS400 AS /
WASH PUMP FILTER
MRS400 AS

00002050:

ELFRAMO SPA



3126143 FILTRO
POMPA LAVAGGIO 42E
/
WASH PUMP FILTER
42E

00200500:

ELFRAMO SPA

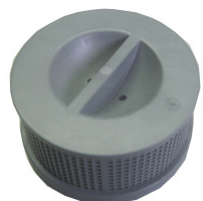

3126308 FILTRO
VASCA B100-201 /
FILTER TANK B100-201

10295: FABAR SRL



3126359 FILTRO
ASPIRAZIONE
LAVATAZZE KRPS /
SUCTION FILTER
DISHWASHERS KRPs

104455: KRUPPS S.R.L.



GASKET=2102575,
BODY=3126361,
OVERFLOW=3111205,
GASKET=2101837,
GHIERA=3126360

3126012 FILTRO
ASPIRAZIONE
DERLING /
SUCTION FILTER
DERLING

904467: SILANOS

SRL

9141499:

GRUPPO CIMBALI SPA

P43:

GRUPPO CIMBALI SPA



3126544 FILTRO
INOX LAVABICCHIERI

/
GLASSWASHER
STAINLESS STEEL
FILTER

3240: KRUPPS S.R.L.



3126539 FILTRO
INOX LAVAPIATTI
CAPOTTA /
FILTER STAINLESS
DISHWASHER HOOD

3260: KRUPPS S.R.L.



3126549 FILTRO
INOX ø 130x90 mm /
INLET FILTER
STAINLESS STEEL ø
130x90 mm

41205514:

MODULAR SPA



3126559 FILTRO
POZZETTO N700
PS_E50_E45 /
FILTER N700
PS_E50_E45

902394: SILANOS

SRL



3126172 FILTRO
CILINDRICO
N45/N50/N90 /
FILTER N45/N50/N90

904469: SILANOS

SRL

30Q1510:

ANGELO PO GRANDI

CUCINE SPA



3126033 FILTRO
ASPIRAZIONE
F45/LF/C75 //
SUCTION FILTER
F45/LF/C75

180808:

COMENDA ALI SPA



3126077 FILTRO
ASPIRAZIONE FC /
SUCTION FILTER FC

180818:

COMENDA ALI SPA

180818:

HOONVED - ALI SPA



3126178 FILTRO
ASPIRAZIONE POMPA /
PUMP SUCTION
FILTER

048324:

ELECTROLUX
PROFESSIONAL
S.P.A.



3126311 FILTRO /
FILTER

049032EX:

ELECTROLUX
PROFESSIONAL
S.P.A.

0L2757:

ELECTROLUX
PROFESSIONAL
S.P.A.



3126279 FILTRO
POMPA LAVAGGIO C44
/
PUMP FILTER C44

00018301:

ELFRAMO SPA



3126282 Z200922000
FILTRO /
Z200922000 FILTER

Z200901000ex:

FAGOR
INDUSTRIALE S.R.L.
12024410:

FAGOR
INDUSTRIALE S.R.L.
Z200922000EX:

FAGOR
INDUSTRIALE S.R.L.



3126303 Z400920000
FILTRO ALTO /
Z400920000 LONG
FILTER

12025219:

FAGOR
INDUSTRIALE S.R.L.



3126161 FILTRO
RACCOGLITORE /
INTERNAL FILTER

32719:

HOONVED - ALI SPA



3126158 FILTRO
ASPIRAZIONE POMPA /
PUMP SUCTION
FILTER

2609690:

LASA SRL



3126325 FILTRO
FILETTATO CORPO
POMPA SERIE S/E /
FILTER FOR BODY
PUMP S / E SERIES

902271: SILANOS

SRL



3126326 FILTRO
ASPIRAZIONE SERIE
S/E /
SUCTION FILTER
SERIES S / E

902273: SILANOS

SRL



3126101 CORPO
FILTRO SUP.D42 FIL.G1
P646 /
UPPER FILTER BODY
D42 FIL. G1 P646

DW540001:

DIHR-ALI SPA

DW540001A:

DIHR-ALI SPA

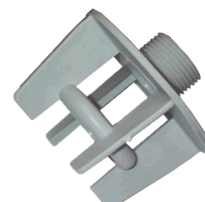

3126092 CORPO
FILTRO SUPERIORE D.
42 /
TOP FILTER BODY D.42

DW540000/A:

DIHR-ALI SPA



3126360 GHIERA PER
GRUPPO ASPIRAZIONE
/
RING NUT FOR GROUP
INTAKE

104450: KRUPPS S.R.L.

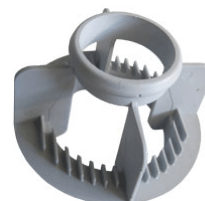

3126171 SUPPORTO
FILTRO
GRIGIO+PROLUNGA /
INTAKE FILTER
HOLDER

65478059:

RANCILIO SPA

*: MBM- EUROTEC

SRL

478059: ELETTOBAR

478045+478046:

ELETTOBAR



3126349 FILTRO
ASPIRAZIONE AISI 304
/
SUCTION FILTER 304

K00012:

ARISTARCO KASTEL

SPA



3126064 FILTRO
ASPIRAZIONE POMPA /
PUMP SUCTION
FILTER

20005:

BREMA ICE MAKERS
SPA



3126121 FILTRO
22X88 COLL.
ELETTROV. /
FILTER 22X88

330526:

COMENDA ALI SPA



Ø=22X88mm

3126085 FILTRO
INOX POMPA SCARICO
L=85 /
DRAIN PUMP
STAINLESS STEEL
FILTER L=85

DW440751:

DIHR-ALI SPA



3126273 FILTRO PER
POMPA SCARICO
LAVASTOVIGLIE /
DRAIN PUMP FILTER

121078:

ELETTROBAR
DIVISIONE DELLA
EUROTEC SRL

*: MBM- EUROTEC
SRL - DIV. COOKING
SERVICE



3126060 FILTRO
POMPETTA SCARICO /
DRAIN PUMP FILTER

31622:

HOONVED - ALI SPA



3126062 FILTRO
PILETTA /
PUMP FILTER

31620:

HOONVED - ALI SPA



3126557 FILTRO /
FILTER

4505: I.T.V. S.A.



L=46mm, Øe=28mm

3126290 FILTRO D.
8,5 X 22 0,75 SP. 0,15 /
FILTER D.8,5X22 0,75
WIDTH 0,15

210084:

MAGISTER SISTEMA
CAFFE' SRL



3126032 FILTRO
DIFFUSORE INT.MAN.
3/8F /
DIFFUSER FILTER 3/8F



3126055 FILTRO
ASPIRAZIONE POMPA
NYLON
MON.ARISTARCO /
NYLON SUCTION
FILTER PUMP MON.
ARISTARCO

1177*:

ARISTARCO KASTEL
SPA

137:

ARISTARCO KASTEL
SPA



3126244 FILTRO
ASPIRAZIONE
COMPLETO AL /
SUCTION FILTER
COMPLETE AL

6820: A.T.A. SRL



3126104 FILTRO
VASCHETTA
BR/BC/FC43 /
TANK FILTER
BR/BC/FC43

330591:

COMENDA ALI SPA



3126339 FILTRO IN
PLASTICA COMPLETO
E78 /
FILTER PLASTIC
COMPLETE E78

80259:

ELETTROBAR
DIVISIONE DELLA
EUROTEC SRL



3126300 FILTRO
VASCA APS
S/SOTTOFILTRO /
TANK FILTER APS

31716:

HOONVED - ALI SPA



3126075 FILTRO
VASCA BHC-HR /
TANK FILTER BHC-HR
180828:
COMENDA ALI SPA



3126073 FILTRO
VASCA LAVABICCIERI
BHC /
TANK FILTER BHC



3126186 FILTRO X
MICROFIL. LAV.LF2004
/
WASHING FILTER FOR
MICROFILTER LF 2004
180832:
COMENDA ALI SPA



3126061 FILTRO
VASCA POLIPROPIL.
43-53 /
POLIPROPIL. TANK
FILTER 43-53
30420EX:
HOONVED - ALI SPA
180848:
HOONVED - ALI SPA



3126110 FILTRO
VASCA POLIP. 43-53/98
/
TANK FILTER 43-53/98
34658:
HOONVED - ALI SPA
180824:
COMENDA ALI SPA



3126223 FILTRO
VASCA POLIP. C 53-60
E /
WASHING FILTER C 53-
60 E
C53; C60E; C6E:
HOONVED - ALI SPA
180831:
COMENDA ALI SPA



3126212 FILTRO
VASCA PREM. APS X
RICAM /
TANK FILTER APS
36180:
HOONVED - ALI SPA



3126113 FILTRO
VASCA PREM.AP /
TANK FILTER AP
21574:
HOONVED - ALI SPA



3126310 FILTRO
VASCA INTERNO /
INTERNAL TANK
FILTER
31717:
HOONVED - ALI SPA

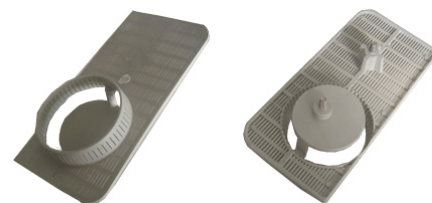

3126150 FILTRO
VASCA CPL C 6 /
TANK FILTER CPL C 6
C60:
HOONVED - ALI SPA



3126026 FILTRO
ASPIRAZIONE MOD 1-2
IME /
SUCTION FILTER MOD
1-2 IME
GA115RVOGR:
OMNIWASH SRL -
SOCIETA' A SOCIO
UNICO



3126196 FILTRO
ASPIR. MOD. 1-2
COMPLETO /
FILTER MOD. 1-2
GA115RCBVOGR:
OMNIWASH SRL
GA115RCOMP:
OMNIWASH SRL
18010642:
NUOVA SIMONELLI
SPA



3126205 PIASTRA
INF. FILTRO ASP. 1-2
STAMPO 147 UNI /
FLAT FILTER 1-2
GA115RAVOGR:
OMNIWASH SRL

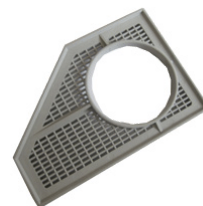

3126009 FILTRO
ASPIRAZIONE IME 4-
62P /
SUCTION FILTER IME
1-2
GA315Rex:
OMNIWASH SRL
QUATTRO; SEI2P:
OMNIWASH SRL -
SOCIETA' A SOCIO
UNICO



3126182 "PIASTRA
INF. FILTRO POMPA
SC.4/82 ""V0"" ST
147UNI" /
PUMP FILTER
GA115RABV0GR:
OMNIWASH SRL -
SOCIETA' A SOCIO
UNICO

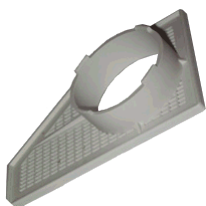

3126107 FILTRO
POMPA ACQUA /
WATER PUMP FILTER
902639: SILANOS
SRL
902590: SILANOS
SRL



3126036 FILTRO
SUPERF.DERLING
C/CILINDRO /
SURFACE FILTER
DERLING WITH
CYLINDER
904465: SILANOS
SRL

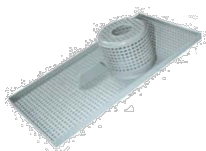

3126027 FILTRO
SUPERF. DERLING
C/CILINDRO /
FILTER DERLING
904463ex:
SILANOS SRL
904464EX:
SILANOS SRL
902636: SILANOS
SRL



3126098 FILTRO
PIANO C 34-C110PLAS /
FILTER C34-C110PLAS
180811:
COMENDA ALI SPA
33895ex:
HOONVED - ALI SPA
180811:
HOONVED - ALI SPA



3126180 FILTRO
ECORINSE ACRS
STAMPATA /
ECORINSE FILTER
ACRS
333009:
COMENDA ALI SPA



3126183 FILTRO
STAMP.SENZA
CASS.900ACS /
PRESSED FILTER
900ACS
333001:
COMENDA ALI SPA

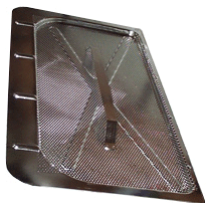

3126292 FILTRO
VASCA DX C 2001 /
RIGHT FILTER C 2001
332090:
COMENDA ALI SPA
332090:
HOONVED - ALI SPA



3126293 FILTRO
VASCA SX C 2001 /
LEFT FILTER C 2001
332091:
COMENDA ALI SPA
332091:
HOONVED - ALI SPA

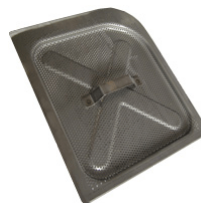

3126122 FILTRO
PIANO INOX C95 C165 /
TANK FILTER C95-
C155-C165
330586:
COMENDA ALI SPA



3126321 FILTRO X
CAPOTTINA PARASPR.
AC /
MUDFLAPS HOOD
TYPE FILTER AC
330581:
COMENDA ALI SPA

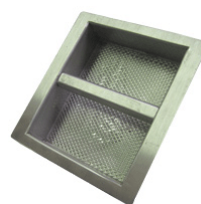

3126108 FILTRO
LAVAGGIO INOX SE/1 /
STAINLESS STEEL
WASHFILTER SE/1
330584:
COMENDA ALI SPA



3126546 FILTRO
VASCA POS. G12/03 &
11/03 /
TANK FILTER G12/03 &
11/03
DW11600907:
DIHR-ALI SPA



DIMENSIONS
290X223mm

3126556 FILTRO
VASCA INOX
INTEGRALE LA50 CPL.
/
TANK FILTER INOX
FOR MODEL LA50
COMPLETE
121121:
ELETTROBAR
DIVISIONE DELLA
EUROTEC SRL



3126117 FILTRO
VASCA LATO T.PIENO
22/A /
TANK FILTER 22/A

121057:

ELETTROBAR
DIVISIONE DELLA
EUROTEC SRL

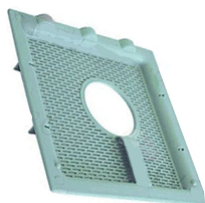

3126118 FILTRO PER
VASCA SP294 22/A
48/28 /
TANK FILTER SP294
22/A 48/28

121056:

ELETTROBAR
DIVISIONE DELLA
EUROTEC SRL

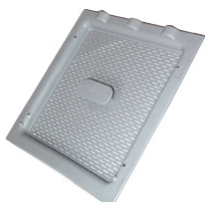

3126548 ASSIEME
FILTRO SUPERFICIE
LP61 /
SURFACE FILTER
320x250 mm

00065523ex:

ELFRAMO SPA

00067144:

ELFRAMO SPA

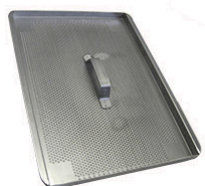

318X226mm

3126289 FILTRO
SUPERFICIE SQ 240 /
FILTER FOR SQ 240

SQ240-DF80:

ELFRAMO SPA

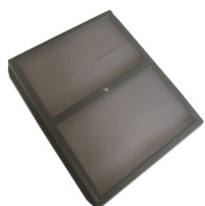

3126558 FILTRO
VASCA ED650/C90/C98 /
TANK FILTER
ED650/C90/C98

34420:

HOONVED - ALI SPA



DIMENSIONS
265X200mm

3126162 FILTRO
VASCA SX INOX SERIE
60 /
LEFT FILTER

35896:

HOONVED - ALI SPA

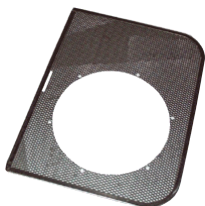

3126163 FILTRO
VASCA DX INOX SERIE
60 /
RIGHT FILTER

35895:

HOONVED - ALI SPA



3126152 FILTRO
CASSETTO PT1500 2959
/
DRAWER FILTER
PT1500 2959

0202007: LAMBER
SRL

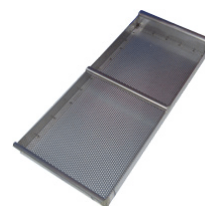

3126353 "FILTRO
SUPERFICIE MOD 2
""V0"" /
SURFACE FILTER MOD
2

LIF22V1PVO:

OMNIWASH SRL -
SOCIETA' A SOCIO
UNICO



3126031 FILTRO
SUPERF. MOD. 4 /
SURFACE FILTER
MOD.4

18010500:

NUOVA SIMONELLI
SPA

LIF4V4PVOGR:

OMNIWASH SRL -
SOCIETA' A SOCIO
UNICO



3126165 FILTRO
SUPERFICIE MODELLO
4 /
SURFACE FILTER
MOD. 4

LIF4V4TPPGR:

OMNIWASH SRL -
SOCIETA' A SOCIO
UNICO



3126137 FILTRO
SUPERF. MOD 4/6 INOX
/
STAINLESS STEEL
SURFACE FILTER
MOD. 4/6

LIF4V4:

OMNIWASH SRL -
SOCIETA' A SOCIO
UNICO

LIF4V4C:

OMNIWASH SRL -
SOCIETA' A SOCIO
UNICO



DIMENSIONS
200x230mm

3126054 FILTRO
SUPERFICIE SILANOS
1300 /
SURFACE FILTER
SILANOS 1300

902629: SILANOS
SRL

902645EX:

SILANOS SRL

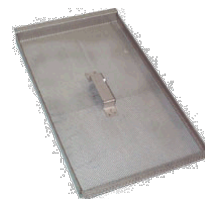

DIMENSIONS
253X417mm

3126028 FILTRO SUP.
DERLING E40-V40 PO /
FILTER DERLING E40-
V4 PO

904460ex:

SILANOS SRL

902635: SILANOS

SRL

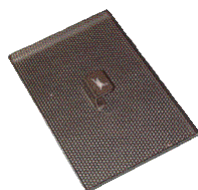

3126131 FILTRO
VASCA PROJECT 350 /
TANK FILTER PROJECT
350

30990:

SISTEMA PROJECT
SERVICE SRL



3126312 Filtro vasca
Compact completo /
COMPLETE TANK
FILTER COMPACT

4721:

UNIVER-BAR SRL

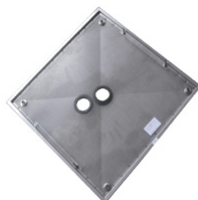

3126302 FILTRO
POMPA DI SCARICO /
FILTER DRAIN PUMP

4728: A.T.A. SRL



3126144 FILTRO /
FILTER

630139:

COMENDA ALI SPA



3126560 MICROFILT
RO FCE+HRT /
MICROFILTER
FCE+HRT

180842:

COMENDA ALI SPA



3126021 FILTRO
LAVASTOVIGLIE
ZANUSSI /
DISH WASHER FILTER
ZANUSSI

045476:

ELECTROLUX
PROFESSIONAL
S.P.A.



3126361 GRUPPO
ASPIRAZIONE
SCARICO LT /
SUCTION DRAIN
GROUP LT

104441: KRUPPS S.R.L.



3126136 FILTRO
DIFFUSORE
COMPLETO 3/8" MAN.
INF. /
"COMPLETE FILTER
3/8"" FOR WATER-
SOFTNER"



3126138 FILTRO
DIFFUSORE PVC 3/8"
SUPERIORE /
"PVC FILTER 3/8"" FOR
WATER-SOFTNER"



3126281 FILTRO
PENTOLA COMP. /
DRAIN FILTER
BOILING POT

30Q0450:

ANGELO PO GRANDI
CUCINE SPA



3126070 FILTRO
PROTEZIONE
ASPIRAZIONE POMPA
F-C70 /
PUMP SUCTION
PROTECTION FILTER
F-C70

180814:

COMENDA ALI SPA



3126078 FILTRO
VASCA FC-HR /
TANK FILTER FC-HR

332006:

COMENDA ALI SPA

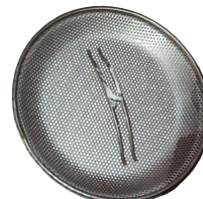

3126079 FILTRO PER
SCARICO FC HR /
"DRAIN FILTER FOR
FC""HR""

180822:

COMENDA ALI SPA

30839:

HOONVED - ALI SPA



3126238 FILTRO
SICUREZZA
ASPIRAZIONE POMPA
C90 /
FILTER SAFETY
INTAKE PUMP -C90
H34430:
COMENDA ALI SPA
34430:
HOONVED - ALI SPA



3126096 FILTRO D.17
LAM.STIRATA /
FILTER D. 17
330543:
COMENDA ALI SPA

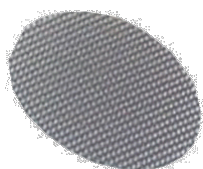

3126129 FONDO
FILTRO CIRCOLARE /
ROUND FILTER
32795:
HOONVED - ALI SPA



3126124 FONDO
FILTRO CIRCOLARE /
ROUND FILTER
32796:
HOONVED - ALI SPA



3126173 FONDO
FILTRO FORO D.30 /
FILTER HOLDER D.30
DW16051:
DIHR-ALI SPA



3126229 FONDO
FILTRO PLASTICA /
FILTER BASE
4158:
UNIVER-BAR SRL



3126320 PREFILTRO
POMPA LAV. D40 /
PRE FILTER WASH
PUMP D40
00012735:
ELFRAMO SPA

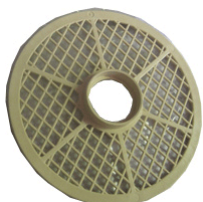

3126208 PROTEZION
E ASPIRAZ. C85-C155 /
BACK FLOW
CONNECTION C85-C155
33452:
HOONVED - ALI SPA
191057:
COMENDA ALI SPA
191057:
HOONVED - ALI SPA



3126111 COPERCHIO
RACCORDO
ASP.PORTAFILTRO V50
/
INTAKE CAP V50
900009: SILANOS
SRL



3126148 FILTRINO
DOSATORE
ARISTARCO /
FILTER ARISTARCO
902568: SILANOS
SRL



ZAVORRA=4115752

3126191 FILTRO
SUPERIORE
RUBINETTO
ADDOLCITORE /
UPPER FILTER FOR
WATER-SOFTNER
COCK



3126175 FILTRO
ANTID.411.13.50007
FAST /
ANTI-NOISE FILTER
4011135007 3 FAST
631214:
COMENDA ALI SPA



3126123 FILTRO
ANTIDISTURBO /
FILTER
DW15149:
DIHR-ALI SPA



3126354 FILTRO RFI
CON CAVETTI /
RFI FILTER WITH
CABLES
048726ex:
ELECTROLUX
PROFESSIONAL
S.P.A.
093636:
ELECTROLUX
PROFESSIONAL
S.P.A.



3126134 FILTRO
ANTIDISTURBO /
ANTI NOISE FILTER
CEFA:
OMNIWASH SRL -
SOCIETA' A SOCIO
UNICO



3126336 FILTRO
ANTIDISTURBO
TRIFASE /
ANTI NOISE FILTER
THREEPHASES
902107: SILANOS
SRL



3126228 FILTRO
ANTIDISTURBO ONDE
ELETTRICHE /
ELECTROMAGNETIC
E /
FILTER
4750:
UNIVER-BAR SRL



3126294 GRUPPO
FILTRO EL.ACS151-202
/
FILTER FOR SOLENOID
ACS151-202
620717:
COMENDA ALI SPA



3126239 FILTRO 3/4
GRADUALE /
FILTER 3/4



3126348 R725064000
FILTRO** /
R725064000 FILTER **
12018840:
FAGOR
INDUSTRIALE S.R.L.



1123005 POMPA
DOSATORE BRILL.
SEKO /
DOSING PUMP FOR
RINSING DETERGENT
SEKO BLUE
00003111:
ELFRAMO SPA



1123008 POMPA
BRILLANTANTE
WINTERHALTER /
DOSING PUMP FOR
RINSING DETERGENT
WINTERHALTER
80000554:
WINTERHALTER
32Z1610:
ANGELO PO



1123002 POMPA
PERISTALTICA /
PERISTALTIC PUMP
0500058:
LAMBER DI AFFABA
FRANCESCO & C.



A= 1123020, B= 1123034

1123013 POMPA
PERISTALTICA 2 LT/H
FISSA /
FIXED PERISTALTIC
PUMP 2 LT/H
9191105:
GRUPPO CIMBALI SPA

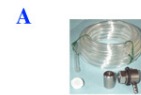
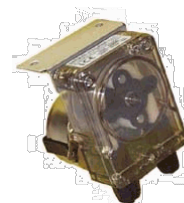

A= 1123044, B= 1123017

1123059 POMPA
PERISTALTICA G150
DETERSIVO FISSA
1,5L/H /
DETERGENT
PERISTALTIC PUMP
G150 1,5L/H

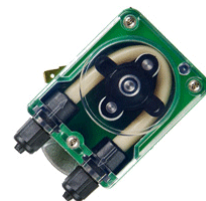

1123018 DOSATORE
DETERSIVO C/REG.2,2
l/h 1 bar /
ADJUSTABLE
DETERGENT DOSING
PUMP 2,2l/h 1 bar



A= 1123020, B= 1123034

1123036 POMPA
PERISTALTICA G300
DETERSIVO /
PERISTALTIC PUMP
G300
9091018:
GRUPPO CIMBALI SPA



A= 1123044, B= 1123017

1123069 POMPA
PERISTALTICA
DETERGENTE
REGOLABILE 2,76LT/H
A TEMPO 230V C/KIT /
ADJUSTABLE
DETERGENT
PERISTALTIC PUMP
2,76LT/H 230V



tube=1123081

1123092 KIT
DOSATORE
DETERGENTE
PERISTALTICO /
KIT OF DOSING
DETERGENT
PERISTALTIC PUMP
41953:
ELETTOBAR
DIVISIONE DELLA
EUROTEC SRL



Ø=6X4mm

1123056 POMPA
PERISTALTICA
DETERSIVO PBR 3 /
DETERGENT
PERISTALTIC PUMP
PBR 3
20155111:
ELFRAMO SPA
34358:
HOONVED - ALI SPA
209016:
ELETTOBAR



= 1123020

1123078 DOSATORE
DETERSIVO
C/SCATOLA CHIUSA E
KIT /
DETERGENT
DISPENSER WITH
CLOSED BOX AND KIT
1220: KRUPPS S.R.L.



tube=1123081, =2,5
LT/H

1123003 DOSATORE
DETERSIVO
C/REGOLAZ. /
ADJUSTABLE
DETERGENT DOSING
PUMP



A
B
A= 1123045, B=
1123035

1123021 POMPA
PERISTALTICA
PARETE 10 lt/h /
WALL ADJ.
PERISTALTIC PUMP 10
lt/h



1123053 DOSATORE
DETERSIVO 24VAC /
DETERGENT DOSING
PUMP 24VAC



1123014 POMPA
PERISTALTICA A
PARETE 3LT/H /
WALL PERISTALTIC
PUMP 3LT/H



1123045

1123047 POMPA
PERISTALTICA
DETERSIVO REG.
VOLUM. 0,6-4l/h 230V
C/KIT /
PERISTALTIC PUMP
0,6-4l/h 230V WITH KIT



1123070 POMPA
PERISTALTICA
DETERGENTE
REGOLABILE 5,8 LT/H
VELOCITA' 230V C/KIT
/ ADJUSTABLE
DETERGENT
PERISTALTIC PUMP
5,8LT/H 230V



TUBE=1123081

1123072 POMPA
PERISTALTICA
DETERGENTE
REGOLABILE
VELOCITA' 6,78LT/H
RICONOSCIMENTO
CARICO RISCIAQUO /
ADJUSTABLE
DETERGENT
PERISTALTIC PUMP
6,78LT/H



1123086 DOSATORE
PERISTALTICO
DETERSIVO DOPPIA
REGOLAZIONE/
DOPPIA
ALIMENTAZIONE /
Peristaltic DETERGENT
DISPENSER DOUBLE
ADJUSTMENT /
DOUBLE POWER



1123015 POMPA
PERIST.C/REG.
BRILLANTANTE 0,6L/H
MAX /
ADJUSTABLE
DETERGENT
PERISTALTIC PUMP



1123020

1123068 POMPA
PERISTALTICA
BRILLANTANTE
REGOLABILE 0,45LT/H
A TEMPO 230V C/KIT /
ADJUSTABLE RINSING
DETERGENT
PERISTALTIC PUMP
0,45LT/H 230V



tube=1123082

1123091 KIT
DOSATORE
BRILLANTANTE /
KIT OF DOSING PUMP
FOR RINSING
DETERGENT

41952:

ELETTROBAR
DIVISIONE DELLA
EUROTEC SRL



Ø=11X5mm, Ø=6X4mm

6104022 DOSATORE
BRILLANTANTE
BORES PROTO X
LAV.C/TEMPORIZZATO
RE /
RINSING DETERGENT
DOSING PUMP BORES

30683:

SISTEMA PROJECT
SERVICE SRL



1123057 POMPA
PERISTALTICA
BRILLANTANTE PBM
0,7 /
RINSE AID
PERISTALTIC PUMP
PBM 0,7

00220401EX:

ELFRAMO SPA

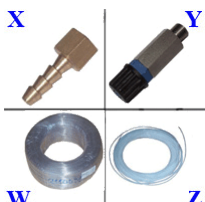

Y= 1123051, X= 1125071, W= 2110091, Z=2110080

1123079 DOSATORE
BRILLANTANTE
C/SCATOLA CHIUSA E
KIT /
ADJUSTABLE RINSING
DETERGENT PUMP



tube=1123082

1123042 DOSATORE
BRILLANTANTE REG.1
L/H + KIT RITEGNO /
DOSING PUMP FOR
RINSING DETERGENT
1 L/H



1123043 DOSATORE
BRILLANTANTE REG.2
L/H + KIT RITEGNO /
ADJ. DOSING PUMP
FOR RINSING
DETERGENT 2 L/H



1123054 DOSATORE
BRILLANTANTE
24VAC / DOSING PUMP
FOR RINSING
DETERGENT 24VAC



1123048 POMPA
PERISTALTICA
REG. VOLUM.0,15-11/h
BRILLANT. 230V C/KIT
/ PERISTALTIC PUMP
0,15-11/h 230V WITH KIT



1123071 POMPA
PERISTALTICA
BRILLANTANTE
REGOLABILE 2,76LT/H
VELOCITA' 230V C/KIT
/ ADJUSTABLE
RINSING DETERGENT
PERISTALTIC PUMP
2,76LT/H 230V



1123076 POMPA
PERISTALTICA
REGOLABILE
VELOCITA' 2,1LT/H
BRILLANTANTE
RICONOSCIMENTO
CARICO /
ADJUSTABLE RINSING
DETERGENT
PERISTALTIC PUMP
1LT/H



1123085 DOSATORE
BRILLANTANTE
ELETTROICO C/KIT PER
LAVASTOVIGLIE
ELETTRONICHE /
ELECTRIC DISPENSER
AID KIT FOR
ELECTRONIC
DISHWASHER
1275K: KRUPPS S.R.L.



1123040 DOSATORE
MAGNETICO
BRILLANTANTE
2LT/6Bar /
DETERGENT PUMP
2LT/6Bar



1123062 DOSATORE
MAGNETICO
BRILLANTANTE /
RINSE AID MAGNETIC
PUMP



1123061 POMPA
DETERGENTE
MAGNETICA
C/CONDUCIMETRO /
MAGNETIC
DETERGENT DOSING
PUMP



1123017 TUBO
SANTOPRENE X 007 /
PUMP SANTOPREN
TUBING X 007

9091026:

GRUPPO CIMBALI SPA



1123031 TUBO
SANTOPRENE X SEKO /
PUMP SANTOPREN
TUBING X SEKO



1123034 TUBETTO X
002-018 /
PUMP SANTOPREN
TUBING X 002-018



1123035 TUBETTO X
003 /
PUMP SANTOPREN
TUBING X 003



1123038 TUBO
POMPA G30 REG. /
PUMP SANTOPREN
TUBING G30

9091028:

GRUPPO CIMBALI SPA



1123058 TUBO
BRILLANTANTE PER
POMPA 1123043 /
TUBING FOR DOSING
PUMP FOR RINSING
DETERGENT 1123043



1123065 TUBO
MEMBRANA P. 6X9
RODATO SEKO
COMPLETO /
MEMBRANE PIPE P.
6X9 SEKO



1123081 TUBO
PERISTALTICO
SANTOPRENE CON
RACCORDO E GHIERA
6X10 (X078) /
SANTOPRENE PIPE
FITTING AND WITH
NUT 6X10 (X078)



= 1123078

1123049 TUBO
POMPA PERISTALTICA
/ PERISTALTIC PUMP
TUBING



1123050 TUBO SEKO
DOSATORE
BRILLANTANTE /
TUBING SEKO FOR
DOSING PUMP FOR
RINSING DETERGENT

20155109:

ELFRAMO SPA



1123055 TUBETTO
COMPLETO
DOSATORE
BRILLANTANTE 015 /
TUBING FOR DOSING
PUMP FOR RINSING
DETERGENT



1123082 TUBO
PERISTALTICO
SILICONE CON
RACCORDI E GHIERA
6X10 (x079) /
SILICON HOSE WITH
FITTINGS AND NUT
6X10 (X079)



=1123079

1123022 TUBO
SANTOPRENE D.4X7 /
PUMP SANTOPREN
TUBING D. 4X7



Ø 4X7mm

1123027 TUBO
SANTOPRENE D.6X9 /
PUMP SANTOPREN
TUBING D.6X9



Ø 6X9mm

2110148 TUBO
SANTOPRENE 6,2X10,5
X PERISTALTICA
1123047 /
PUMP SANTOPREN
TUBING 6,2X10,5 FOR
PART NUMBER 1123047



Ø 6,2X10,5mm

2110150 TUBO
SANTOPRENE 4,8X8 X
POMPA PERISTALTICA
1123007 /
PUMP SANTOPREN
TUBING 4,8X8 FOR
PART NUMBER 1123007



Ø 4,8X8mm

2110149 TUBO
SILICONE 3X8
TRASPARENTE X
PERISTALTICA 1123048
/ PUMP SILICONE
TUBING 3X8 FOR PART
NUMBER 1123048

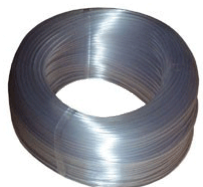

Ø 3X8mm

2110151 TUBO
SILICONE 4X8 POMPA
PERISTALTICA 1123015
/ PUMP SILICONE
TUBING 4X8 FOR PART
NUMBER 1123015

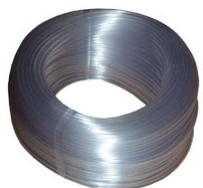

Ø 4X8mm

1123019 VALVOLA
NON RITORNO X
BRILLANTANTE
ATTACCO FEMMINA /
VALVE FOR
PERISTALTIC PUMP
FEMALE
6535:
ARISTARCO SPA



1123051 VALVOLA
NON RITORNO
DOSATORE SEKO
BRILL. /
VALVE FOR
PERISTALTIC PUMP
SEKO



1123073 VALVOLA
NON RITORNO
BRILLANTANTE
COMPLETA DI
PORTAGOMMA /
VALVE FOR
PERISTALTIC PUMP



1123088 VALVOLA
NON RITORNO PVC
BRILLANTANTE /
CHECK VALVE PVC
RINSEID



=1123079, =1123068

1123030 VALVOLA
PESCAGGIO
FILTRO+RITEGNO /
SUCTION VALVE FOR
PERISTALTIC PUMP
11566: **ADLER S.P.A.**



4115478 PORTAGOM
MA GOMITO INOX /
INJECTOR S/S FOR
DETERGENT INJ.
65468151:
RANCILIO SPA
EX180308:
COMENDA ALI SPA
468151:
ELETTROBAR
468151:
MBM



4120027 PORTAGOM
MA IN ACCIAIO /
INJECTOR S/S FOR
DETERGENT INJ.



1123052 INIETTORE
DETERSIVO BIANCO
COMP /
INJECTOR CLEANER
WHITE COMPLETE
DSDET040BGR:
OMNIWASH SRL -



1123020 CORREDO
PERISTALTICA INOX X
002/018 /
STAINLESS STEEL
PERISTALTIC PUMP
KIT



1123044 CORREDO
PERISTALTICA INOX X
007/013 /
STAINLESS STEEL
PERISTALTIC PUMP
KIT X 007/013



1123045 CORREDO
PERISTALTICA CON
VALVOLA PESCAGGIO
FILTRO X 003/014 /
STAINLESS STEEL
PERISTALTIC PUMP
KIT X 003/014



1123023 FASCETTA
METALLICA X022 /
BAND X022



1123028 FASCETTA
METALLICA X TUBO
027 /
BAND X TUBING 027



1123024 RACCORDO
TUBO X022 /
PIPE-FITTING X022



1123025 GHIERA X
RACCORDO 24-26 /
METAL RING FOR
PIPE-FITTING 24-26



1123026 RACCORDO
X TUBO 027 /
PIPE-FITTING X 027



1123032 RULLINO
COMPLETO /
COMPLETE ROLL



6104003 POMPETTA
BRILLANTE
COMENDA /
RINSING DETERGENT
PUMP COMENDA
620120:
HOONVED - ALI SPA
620120:
COMENDA ALI SPA

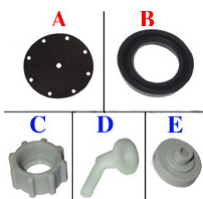

A= 2105008,
B=2105009, C=4115420,
D= 4115419, E= 4115421

6104007 DOSATORE
BRILLANTE MOD.
3000 /
RINSING DETERGENT
DOSING PUMP MOD.
3000
9191002:
GRUPPO CIMBALI SPA
0599999:
LAMBER DI AFFABA
FRANCESCO & C.
3489010: LASA SRL

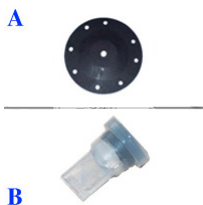

A= 2105004, B=2105003

DW10599999*:
DIHR-ALI SPA
COMPACT,CF35,CF70,
CF235,CF1000,DS400:
ADLER S.P.A.
902203:
SILANOS SRL
69000291:
RANCILIO SPA
843907: TEIKOS SRL
1200: KRUPPS S.R.L.

6104011 DOSATORE
BRILL.+FILTRINO+RAC
CORDI / RINSING
DETERGENT DOSING
PUMP+FILTER+CONNE
CTION
3489030: LASA SRL
049484:
ELECTROLUX
PROFESSIONAL
S.P.A.
60: ARISTARCO SPA



=2105003

6104006 DOSATORE
BRILLANTE IME
NT / SHINING
DETERGENT DOSING
PUMP IME NT
DSAM3NTGR:
OMNIWASH SRL -
SOCIETA' A SOCIO
UNICO



A=2105002, B=2105012

6104026 DOSATORE
BRILLANTE 2001 /
RINSING DETERGENT
DOSING PUMP 2001
DW10799G:
DIHR-ALI SPA
902018:
SILANOS SRL



B=2105003, A=2105001

6104030 DOSATORE
BRILL. SU POMPA
SEKO /
DOSER RINSE
902013:
SILANOS SRL



6104020 DOSATORE
BRILLANTE TIPO
1000 D.8 /
RINSING DETERGENT
DOSING PUMP TYPE
1000 D. 8
DW10799A:
DIHR-ALI SPA



6104024 DOSATORE
BRILLANTANTE DIHR
PRESS.IDRICA /
RINSING DETERGENT
DOSING PUMP DIHR

471101100:

MODULAR SPA

33D3240:

ANGELO PO GRANDI

CUCINE SPA

DW10599999:

DIHR-ALI SPA

L7012: LUXIA SRL



6104012 DOSATORE
BRILLANTANTE
HOONVED /
RINSING DETERGENT
DOSING PUMP
HOONVED

C43:

HOONVED - ALI SPA

620788:

COMENDA ALI SPA



A



B



A= 2105007, B=2105003

6104028 DOSATORE
BRILL. GIALLO C43/46E
/ RINSING DETERGENT
DOSING PUMP C43/46E

35991:

HOONVED - ALI SPA



A

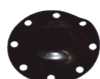

B



A= 2105007, B=2105003

6104029 DOSATORE
BRILL. GIALL. C/STS /
DOSER RINSE AID
PRESSURE

35388:

HOONVED - ALI SPA

H35388:

COMENDA ALI SPA



A

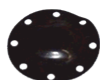

B



A=2105007, B=2105003

6104018 DOSATORE
BRILLANTANTE
DEPR. POMPA /
RINSING DETERGENT
DOSING PUMP



6104019 GRUPPO

DOSATORE
IDRAULICO /
HYDRAULICAL
DOSING PUMP

987023:

ELETTROBAR

DIVISIONE DELLA

EUROTEC SRL



= 2105011

6104027 POMPA
DOS. BRILL. SEKO 26277

01 01 RIVER /

RINSING DETERGENT

DOSING PUMP SEKO

26277 01 01 RIVER

209025:

ELETTROBAR

DIVISIONE DELLA

EUROTEC SRL



6104032 POMPA

DOSATORE

BRILLANTANTE IDR

SEKO DIB5 /

DOSING PUMP RINSE

IDR SEKO DIB5

20155117:

ELFRAMO SPA



6104009 DOSATORE

BRILLANTANTE N6

ATA /

RINSING DETERGENT

DOSING PUMP N6 ATA

DW15108L:

DIHR-ALI SPA

33D0380:

ANGELO PO GRANDI

CUCINE SPA

AL03, AL60, AF61,

AF88, AT95, AT116:

A.T.A. SRL



6104010 DOSATORE

LANG /

RINSING DETERGENT

DOSING PUMP LANG

33D2300:

ANGELO PO GRANDI

CUCINE SPA

902199:

SILANOS SRL



2105001 MEMBRAN

A SILICONE DOS.

1000/2000 /

SILICONE MEMBRANE

DOSING PUMP 1000

10562: ADLER S.P.A.



2105007 MEMBRAN

A DOSATORE HNV /

MEMBRANE DOSING

PUMP HNV

630632:

COMENDA ALI SPA

31596:

HOONVED - ALI SPA



2105008 MEMBRAN
A DOSATORE
BRILLANTANTE 003 /
DOSING PUMP
MEMBRANE FOR
RINSING DETERGENT
630614:
COMENDA ALI SPA

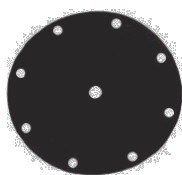

2105015 MEMBRAN
A X DOSATORE
BRILL. TECNOPRO /
POLISHER DOSER
MEMBRANE
DW10807:
DIHR-ALI SPA



2105004 MEMBRAN
A DOSATORE 007 /
MEMBRANE DOSING
PUMP 6104007
984347000:
GRUPPO CIMBALI
SPA
40147: ADLER S.P.A.
DW10599999A:
DIHR-ALI SPA
9011021:
GRUPPO CIMBALI
SPA



2105002 MEMBRAN
A DOSATORE IME /
MEMBRANE DOSING
PUMP IME
DS06M3:
OMNIWASH SRL -
SOCIETA' A SOCIO
UNICO

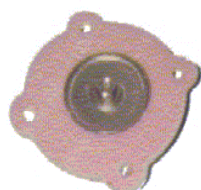

2105006 MEMBRAN
A POMPETTA
ADDITIVO RANCILIO /
ADDITIVE PUMP
MEMBRANE
RANCILIO
36206007:
RANCILIO SPA

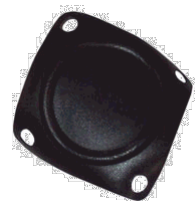

2105003 VALVOLIN
A DOSATORE 1/2/3000 /
DOSING PUMP VALVE
1/2/3000
200444:
COMENDA ALI SPA
40044: ADLER S.P.A.
DW10705D:
DIHR-ALI SPA
0100018:
GRUPPO CIMBALI
SPA
25211:
HOONVED - ALI SPA



2105010 VALVOLIN
A RITEGNO
SIL.ELASTOSIL SH.35 /
NOZZLE VALVE SH.35
144012:
ELETTROBAR
DIVISIONE DELLA
EUROTEC SRL
144026:
ELETTROBAR
DIVISIONE DELLA
EUROTEC SRL



2105011 MEMBRAN
A A SOFFIETTO
DOSATORE
IDRAULICO /
DOSING PUMP
MEMBRANE FOR
RINSING DETERGENT
*:
MBM- EUROTEC SRL -
DIV. COOKING
SERVICE
199012:
ELETTROBAR
DIVISIONE DELLA
EUROTEC SRL



2105016 VALVOLE+
MOLLE(2)DOS.BRILL.T
ECNOPRO /
TECNOPRO NON
RETURN VALVE
DW10805:
DIHR-ALI SPA



2105017 MEMBRAN
A ELETTROVALVOLA /
VALVE MEMBRANE
09135: FABAR SRL



2105012 VALVOLIN
A SILICONE
DOSATORE /
NOZZLE VALVE
DS8S:
OMNIWASH SRL -
SOCIETA' A SOCIO
UNICO



2105009 GUARNIZIO
NE DOSATORE
BRILLANTANTE /
RINSING DETERGENT
DOSING PUMP
GASKET
440405:
COMENDA ALI SPA



1143004 KIT ANALISI
DUREZZA ACQUA 0-
150MG/L /
WATER HARDNESS
TEST KIT



1143006 SIGILLANTE
RACCORDI PTFE 100ml
/
TEFLON PTFE
SEALING PASTE 100ml



1143020 ADESIVO
ISTANTANEO
MULTIUSO (f120gr) /
MULTIUSE
INSTANTANEOUS
ADHESIVE (f120gr)



1143021 LIQUIDO
SERRAFILETTI -
55°/+150° (tb50ml) /
TERMINAL-THREAD
LIQUID -55°/+150°
(tb50ml)



1143019 TUBO
GUARNIZIONE
LIQUIDA -55°/+200°
(75ml) /
LIQUID GASKET PIPE -
55°/+150° (75ml)



1143013 BARATTOL
O LOCTITE 55 /
LOCTITE POT 55



1143056 NASTRO
P.T.F.E. SPESSORE
12MT X 12mmX0,1 mm /
RIBBON P.T.F.E. 12MT
X 12mm x THICKNESS
0.1mm



1143007 GRASSO
150GR ALTA
TEMPERATURA /
HIGH TEMPERATURE
OILY 150GR



1143062 GRASSO AL
SILICONE PTFE NSF
100G /
SILICONE OILY PTFE
NSF 100G



1143025 PULITORE
LUCIDANTE ACCIAIO
800ml -INOX CLEANER
/
STAINLESS STEEL
POLISHING CLEANER
800ML



1143009 SPRAY AIR
98 400ml /
SPRAY AIR 98 400ml



1143042 SPRAY
RILEVATORE FUGHE
DI GAS /
GASDETEKTOR SPRAY



1143029 BARATTOL
O CC250 C/TAPPO /
POT CC250 WITH
STOPPER



1143017 CONFEZION
E S&P DS-CRT GR 1000
/
CALCIUM REMOVER
PACKING S&P DS-CRT
GR 1000



1143045 DISINCROST
ANTE ANTICALCARE
ALL'ACETO 500ML /
VINEGAR ANTI-
LIMESTONE SCALE-
REMOVER 500ML



1143059 SCALEKLEE
N CONFEZIONE 1 KG /
SCALEKLEEN
PACKAGE 1 KG



1143023 FUSTINO
ASCOR BAR
LAVASTOVIGLIE 10LT-
12KG /
CAN ASCOR BAR DISH-
WASHERS 10LT



1143044 FUSTINO
LT10 DETERSIVO
LAVASTOVIGLIE /
CAN 10LT DETERGENT
FOR DISH-WASHER



1143024 FUSTINO 5
LT BRILLANTANTE /
CAN 5LT ASCOR AD



1143028 SACCO KG
25 DT-CF /
SACK 25KG DT-CF



1143040 ACTIVATED
SCALE REMOVER 28 G
/
ACTIVATED SCALE
REMOVER 28 G



1143041 SCALE
KLEEN SCALE
REMOVER /
SCALE KLEEN SCALE
REMOVER



1143052 SANITISING
BAG /
SANITISING BAG
65090900:
SCOTSMAN ICE SRL



SPIE LUMINOSE / LUMINOUS LIGHTS



S&P CODE	TYPE	DIMENSIONI DIMENSIONS	V	COLORE COLOR	S&P CODE	TYPE	DIMENSIONI DIMENSIONS	V	COLORE COLOR
1104013	A	Ø=10mm	230V	ARANCIO ORANGE	1104072	D	Ø=12mm	250V	VERDE GREEN
1104012	A	Ø=10mm	230V	VERDE GREEN	1104073	D	Ø=12mm	250V	ROSSO RED
1104071	B	Ø=10mm	250V	ARANCIO ORANGE	1104034	F	Ø=12mm	250V	ARANCIO ORANGE
1104070	B	Ø=10mm	250V	VERDE GREEN	1104033	F	Ø=12mm	250V	VERDE GREEN
1104107	B	Ø=10mm	250V	VERDE GREEN	1104032	F	Ø=12mm	250V	ROSSO RED
1104069	B	Ø=10mm	250V	ROSSO RED	1104042	E	Ø=10mm	380V	ARANCIO ORANGE
1104024	C	Ø=10mm	250V	ARANCIO ORANGE	1104044	E	Ø=10mm	380V	VERDE GREEN
1104025	C	Ø=10mm	250V	VERDE GREEN	1104043	E	Ø=10mm	380V	ROSSO RED
1104062	D	Ø=10mm	250V	ARANCIO ORANGE	1104066	B	Ø=10mm	400V	ARANCIO ORANGE
1104060	D	Ø=10mm	250V	VERDE GREEN	1104068	B	Ø=10mm	400V	VERDE GREEN
1104061	D	Ø=10mm	250V	ROSSO RED	1104067	B	Ø=10mm	400V	ROSSO RED
1104057	E	Ø=10mm	250V	ARANCIO ORANGE	1104232	B	Ø=10mm	12V	ROSSO RED
1104058	E	Ø=10mm	250V	VERDE GREEN	1104063	B	Ø=10mm	24V	ARANCIO ORANGE
1104059	E	Ø=10mm	250V	ROSSO RED	1104065	B	Ø=10mm	24V	VERDE GREEN
1104087	B	Ø=12mm	250V	ARANCIO ORANGE	1104064	B	Ø=10mm	24V	ROSSO RED
1104086	B	Ø=12mm	250V	VERDE GREEN	1104054	E	Ø=10mm	24V	ARANCIO ORANGE
1104085	B	Ø=12mm	250V	ROSSO RED	1104055	E	Ø=10mm	24V	VERDE GREEN
1104074	D	Ø=12mm	250V	ARANCIO ORANGE	1104056	E	Ø=10mm	24V	ROSSO RED



S&P CODE	TYPE	DIMENSIONI DIMENSIONS	V	COLORE COLOR	S&P CODE	TYPE	DIMENSIONI DIMENSIONS	V	COLORE COLOR
1104029	D	Ø=10mm L=200mm	230V	VERDE GREEN	1104078	F	Ø=6mm L=200mm	380V	VERDE GREEN
4118166	E	Ø=10mm L=400mm	230-400V	VERDE GREEN	1104077	F	Ø=6mm L=200mm	380V	ROSSO RED
1104084	F	Ø=6mm L=200mm	250V	ARANCIO ORANGE	1104237	D	Ø=10mm L=200mm	380V	VERDE GREEN
1104080	F	Ø=6mm L=200mm	250V	VERDE GREEN	1104051	C	Ø=10mm L=200mm	400V	ARANCIO ORANGE
1104083	F	Ø=6mm L=200mm	250V	ROSSO RED	1104053	C	Ø=10mm L=200mm	400V	VERDE GREEN
1104267	F	Ø=6mm L=200mm	250V	BLU BLUE	1104052	C	Ø=10mm L=200mm	400V	ROSSO RED
1104045	C	Ø=10mm L=200mm	250V	ARANCIO ORANGE	1104201	B	Ø=12mm	400V	ARANCIO ORANGE
1104047	C	Ø=10mm L=200mm	250V	VERDE GREEN	1104199	B	Ø=12mm	400V	VERDE GREEN
1104046	C	Ø=10mm L=200mm	250V	ROSSO RED	1104200	B	Ø=12mm	400V	ROSSO RED
1104178	A	Ø=12mm	250V	ARANCIO ORANGE	1104082	F	Ø=6mm L=200mm	24V	ARANCIO ORANGE
1104179	A	Ø=12mm	250V	VERDE GREEN	1104081	F	Ø=6mm L=200mm	24V	VERDE GREEN
1104177	A	Ø=12mm	250V	ROSSO RED	1104079	F	Ø=6mm L=200mm	24V	ROSSO RED
1104181	B	Ø=12mm	250V	ARANCIO ORANGE	1104048	C	Ø=10mm L=200mm	24V	ARANCIO ORANGE
1104182	B	Ø=12mm	250V	VERDE GREEN	1104050	C	Ø=10mm L=200mm	24V	VERDE GREEN
1104180	B	Ø=12mm	250V	ROSSO RED	1104049	C	Ø=10mm L=200mm	24V	ROSSO RED
1104076	F	Ø=6mm L=200mm	380V	ARANCIO ORANGE	1104222	D	Ø=10mm	24V	BIANCO WHITE

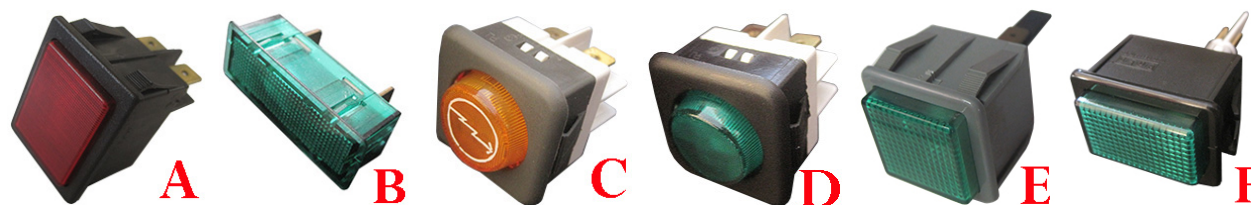

S&P CODE	TYPE	DIMENSIONI DIMENSIONS	V	COLORE COLOR	S&P CODE	TYPE	DIMENSIONI DIMENSIONS	V	COLORE COLOR
1104014	C	25X25mm	220V	ARANCIO ORANGE	1104039	A	22X30mm	230V	VERDE GREEN
1104197	D	25X25mm	220V	VERDE GREEN	1104040	A	22X30mm	230V	ROSSO RED
1104106	E	28,5X28,5mm	220V	VERDE GREEN	1104176	B	10X34mm	400V	ARANCIO ORANGE
1105209	F	22X32mm	220V	VERDE GREEN	1104175	B	10X34mm	400V	VERDE GREEN
1104041	A	22X30mm	230V	ARANCIO ORANGE	1104218	A	22X30mm	24V	ARANCIO ORANGE

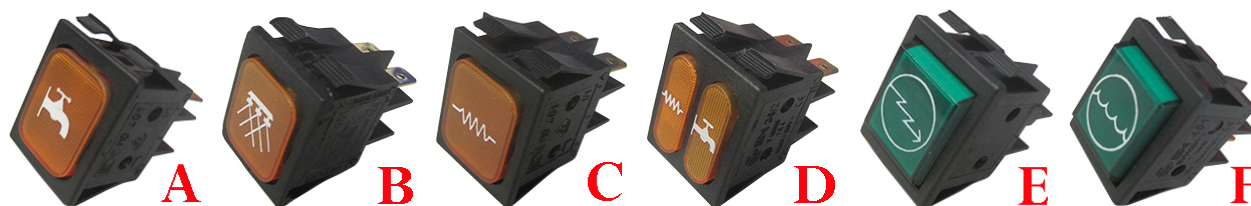

S&P CODE	TYPE	DIMENSIONI DIMENSIONS	V	COLORE COLOR	S&P CODE	TYPE	DIMENSIONI DIMENSIONS	V	COLORE COLOR
1104143	A	22X28mm	220V	ARANCIO ORANGE	1104134	E	22X28mm	220V	VERDE GREEN
1104146	B	22X28mm	220V	ARANCIO ORANGE	1104140	F	22X28mm	220V	VERDE GREEN
1104148	C	22X28mm	220V	ARANCIO ORANGE	1104147	B	22X28mm	12V	ARANCIO ORANGE
1104149	D	22X28mm	220V	ARANCIO ORANGE	1104150	C	22X28mm	12V	ARANCIO ORANGE

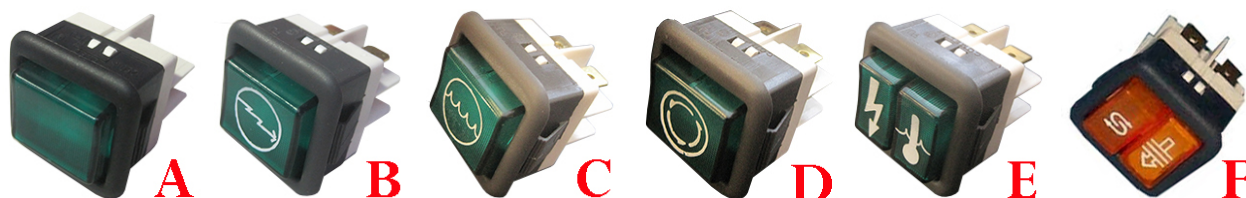

S&P CODE	TYPE	DIMENSIONI DIMENSIONS	V	COLORE COLOR	S&P CODE	TYPE	DIMENSIONI DIMENSIONS	V	COLORE COLOR
1104174	A	25X25mm	220V	VERDE GREEN	1104098	E	25X25mm	220V	VERDE GREEN
1104094	B	25X25mm	220V	VERDE GREEN	1104100	E	25X25mm	220V	BIANCO WHITE
1104136	B	25X25mm	220V	BIANCO WHITE	1104089	F	25X25mm	220V	ARANCIO ORANGE
1104095	C	25X25mm	220V	VERDE GREEN	1104142	B	25X25mm	12V	VERDE GREEN
1104138	C	25X25mm	220V	BIANCO WHITE	1104144	B	25X25mm	12V	BIANCO WHITE
1104015	C	25X25mm	220V	BIANCO WHITE	1104141	D	25X25mm	12V	VERDE GREEN
1104137	C	25X25mm	220V	BLU BLUE	1104145	D	25X25mm	12V	BIANCO WHITE
1104096	D	25X25mm	220V	VERDE GREEN	1104097	D	25X25mm	24V	VERDE GREEN
1104139	D	25X25mm	220V	BIANCO WHITE	1104099	D	25X25mm	24V	BIANCO WHITE
1104135	D	25X25mm	220V	BIANCO WHITE					



S&P CODE	TYPE	DIMENSIONI DIMENSIONS	V	COLORE COLOR	S&P CODE	TYPE	DIMENSIONI DIMENSIONS	V	COLORE COLOR
1104196	F	Foro Int. Ø=6mm	220V	VERDE GREEN	1104002	A	Ø=8mm	230V	ARANCIO ORANGE
1104259	E	Incasso Ø=7mm L=550mm	220V	ROSSO RED	1104037	B	Ø=8mm L=300mm	230V	VERDE GREEN
1104261	D	Foro Int. Ø=6mm L=300mm	230V	VERDE GREEN	1104215	C	Foro Int. Ø=6mm L=140mm	5V	VERDE GREEN
1104235	F	Foro Int. Ø=6mm	230V	ARANCIO ORANGE	1104102	D	Foro Int. Ø=6mm L=300mm	24V	VERDE GREEN
1104120	A	Ø=8mm	230V	FLUORESCENTE FLUORESCENT	1104184	B	Ø=8mm L=300mm	115V	VERDE GREEN
1104121	A	Ø=8mm	230V	BIANCO WHITE					



S&P CODE	TYPE	DIMENSIONI DIMENSIONS	V	COLORE COLOR	S&P CODE	TYPE	DIMENSIONI DIMENSIONS	COLORE COLOR
1104207	A	Foro Int. Ø=5mm L=250mm	230V	BIANCO WHITE	1104253	D	Ø=10mm 14X14mm	VERDE GREEN
1104104	B	Ø=6mm		ARANCIO ORANGE	1104186	D	Ø=10mm 14X14mm	VERDE CON LOGO GREEN WITH LOGO
1104198	B	Ø=6mm		VERDE GREEN	1104027	E	Ø=10mm	ARANCIO ORANGE
1104205	B	Ø=6mm		GIALLO YELLOW	1104038	F	Ø=12mm	VERDE GREEN
1104260	C	Ø=10mm		ROSSO RED	1104036	F	Ø=12mm	ROSSO RED
1104091	D	Ø=10mm 12X12mm		ARANCIO ORANGE	1104151	F	Ø=12mm	ARANCIO ORANGE
1104185	D	Ø=10mm 14X14mm		ARANCIO CON LOGO ORANGE WITH LOGO				

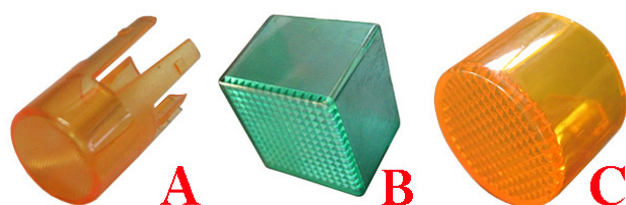



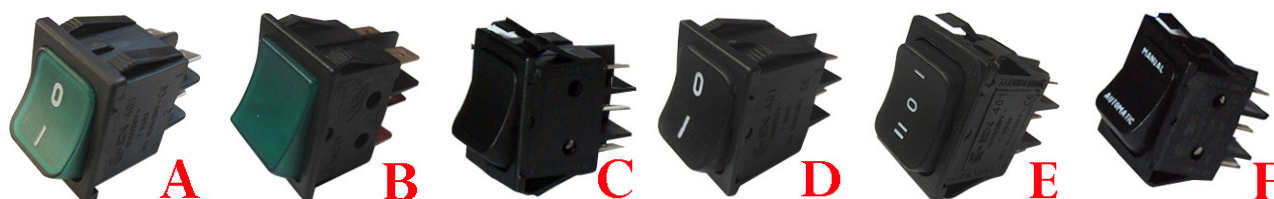

S&P CODE	TYPE	DIMENSIONI DIMENSIONS	COLORE COLOR	S&P CODE	TYPE	DIMENSIONI DIMENSIONS	COLORE COLOR
1104276	A	Ø=16mm	ARANCIO ORANGE	1104119	B	23X23mm	VERDE GREEN
1104238	A	Ø=16mm	VERDE GREEN	1104116	C	Ø=23mm	ARANCIO ORANGE
1104210	A	Ø=16mm	BLU BLUE	1104117	C	Ø=23mm	VERDE GREEN
1104118	B	23X23mm	ARANCIO ORANGE				

INTERRUTTORI / SWITCHES

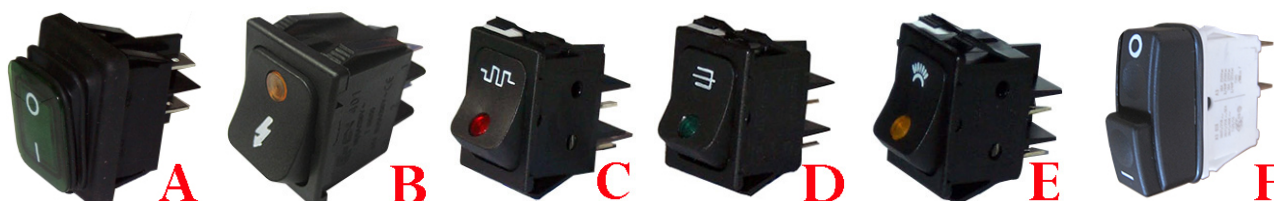

S&P CODE	TYPE	DIMENSIONI DIMENSIONS	POLI POLES	V	COLORE COLOR	S&P CODE	TYPE	DIMENSIONI DIMENSIONS	POLI POLES	V	COLORE COLOR
1105205	C	22X28mm	4	230V	NERO BLACK	1105198	A	22X30mm	4	230V 380V	VERDE GREEN
1105204	C	22X28mm	6	230V	NERO BLACK	1105345	A	22X30mm	5	230V	BLU BLUE
1105224	C	22X28mm	4	230V	BIANCO WHITE	1105045	A	22X30mm	4	230V	NON LUMINOSO NERO BLACK SWITCH NOT LUMINOUS
1105201	F	22X28mm	6	230V	NERO BLACK	1105066	D	13X20mm	4	250V	NERO BLACK
1105008	A	22X30mm	4	230V	VERDE GREEN	1105045	D	22X30mm	4	250V	NERO BLACK
1105007	A	22X30mm	6	230V	VERDE GREEN	1105178	E	22X28mm	6	250V	NERO BLACK
1105006	A	22X30mm	4	230V	ROSSO RED	1105335	B	22X30mm	6	24V	VERDE GREEN
1105044	A	22X30mm	4	230V	ARANCIO ORANGE						



S&P CODE	TYPE	DIMENSIONI DIMENSIONS	POLI POLES	V	COLORE COLOR	S&P CODE	TYPE	DIMENSIONI DIMENSIONS	POLI POLES	V	COLORE COLOR
1105217	A	22X28mm	4	230V	VERDE GREEN	1105200	E	22X28mm	4	230V 380V	ARANCIO ORANGE
1105246	A	22X28mm	4	230V	ARANCIO ORANGE	1105001	B	22X30mm	4	250V	
1105247	A	22X28mm	4	230V	ROSSO RED	1105002	B	22X30mm	4	250V	
1105243	A	22X28mm	4	230V	NERO NON LUMINOSO BLACK SWITCH NOT LUMINOUS	1105003	B	22X30mm	4	250V	
1105196	C	22X28mm	4	230V 380V	ROSSO RED	1105046	B	22X30mm	4	250V	
1105199	D	22X28mm	4	230V 380V	VERDE GREEN	1105405	F	11X27mm	2	250V	NERO BLACK

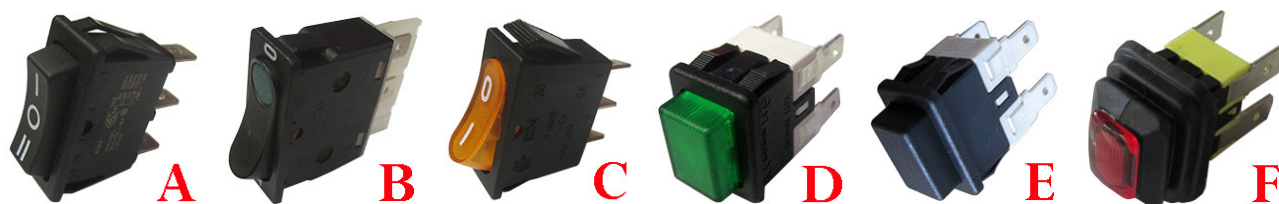

S&P CODE	TYPE	DIMENSIONI DIMENSIONS	POLI POLES	V	COLORE COLOR	S&P CODE	TYPE	DIMENSIONI DIMENSIONS	POLI POLES	V	COLORE COLOR
1105049	A	11X27mm	3	250V	NERO BLACK	1105319	D	13X20mm	4	250V	VERDE GREEN
1105256	B	12X35mm	4	250V	VERDE GREEN	1105239	E	13X20mm	4	250V	NERO BLACK
1105185	C	11X27mm	3	250V	ARANCIO ORANGE	1105324	F	13X20mm	4	250V	VERDE GREEN
1105375	C	11X27mm	3	250V	NERO BLACK	1105328	F	13X20mm	4	250V	ROSSO RED



S&P CODE	TYPE	DIMENSIONI DIMENSIONS	POLI POLES	V	COLORE COLOR	S&P CODE	TYPE	DIMENSIONI DIMENSIONS	POLI POLES	V	COLORE COLOR
1105055	A	13X20mm	4	230 V	INTERRUTTORE ACQUA WATER SWITCH	1105288	D	22X30mm	4	250 V	ROSSO-VERDE RED- GREEN
1105056	A	13X20mm	4	230 V	PULSANTE ACQUA WATER PUSH-BUTTON	1105306	E	22X28mm	6	250 V	BIANCO-NERO WHITE-BLACK
1105057	B	13X20mm	4	230 V	INTER. NERO BLACK SWITCH	1105325	F	21X43mm	2	240 V	VERDE-ROSSO GREEN- RED
1105053	C	22X30mm	4	250 V	LUMINOSO LUMINOUS	1105320	G	34X36mm	6	15V	BIANCO WHITE



S&P CODE	TYPE	DIMENSIONI DIMENSIONS	POLI POLES	V	COLORE COLOR	S&P CODE	TYPE	DIMENSIONI DIMENSIONS	POLI POLES	V	COLORE COLOR
1105033	A	Ø=25mm	4	230V	ROSSO RED	1105343	C	Ø=25mm	4	230V	VERDE GREEN
1105034	A	Ø=25mm	4	230V	ARANCIO ORANGE	1105037	D	CAPPUCCIO PROTEZIONE RETTANGOLARE RECTANGULAR PROTECTION CAP			
1105035	A	Ø=25mm	4	230V	VERDE GREEN	1105038	E	CAPPUCCIO PROTEZIONE TONDO ROUND PROTECTION CAP			
1105248	B	Ø=25mm	4	230V	ARANCIO ORANGE	1105337	F	CAPPUCCIO PROTEZIONE QUADRATO SQUARE PROTECTION CAP			

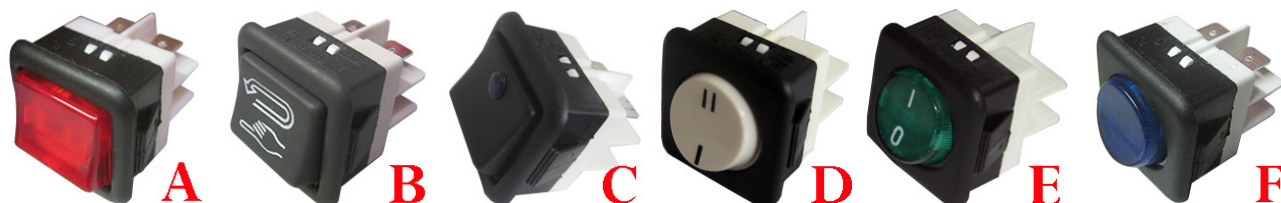

S&P CODE	TYPE	DIMENSIONI DIMENSIONS	POLI POLES	V	COLORE COLOR	S&P CODE	TYPE	DIMENSIONI DIMENSIONS	POLI POLES	V	COLORE COLOR
1105235	A	25X25mm	4	220V	ROSSO RED	1105179	B	25X25mm	6	250V	
1105236	A	25X25mm	4	220V	ARANCIO ORANGE	1105183	B	25X25mm	6	250V	
1105237	A	25X25mm	4	220V	VERDE GREEN	1105357	C	25X25mm	4	250V	BLU BLUE
1105238	A	25X25mm	4	220V	BLU BLUE	1105346	D	25X25mm	2	250V	BIANCO WHITE
1105301	F	25X25mm	4	230V	BLU BLUE	1105347	D	25X25mm	6	250V	BIANCO WHITE
1105166	B	25X25mm	6	250V		1105308	E	25X25mm	4	250V	VERDE GREEN
1105180	B	25X25mm	6	250V							

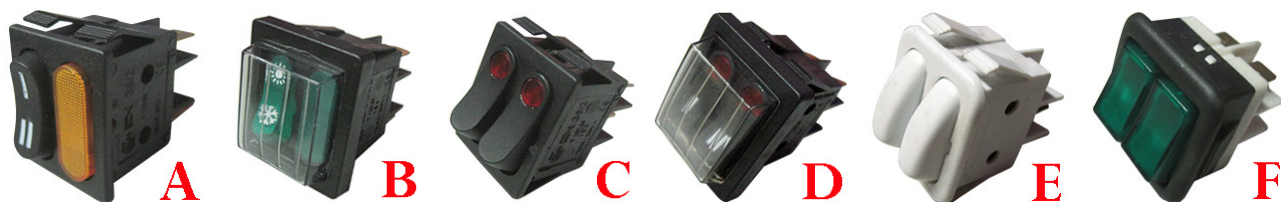

S&P CODE	TYPE	DIMENSIONI DIMENSIONS	POLI POLES	V	COLORE COLOR	S&P CODE	TYPE	DIMENSIONI DIMENSIONS	POLI POLES	V	COLORE COLOR
1105047	A	22X28mm	4	250V	ARANCIO ORANGE	1105206	D	22X28mm	6	230V 380V	ROSSO RED
1105186	A	22X28mm	4	250V	BIANCO WHITE	1105292	E	22X28mm	4	250V	BIANCO WHITE
1105101	B	22X28mm	5	250V	VERDE GREEN	1105254	F	25X25mm	6	250V	VERDE GREEN
1105050	C	22X28mm	6	250V	ROSSO RED						

PULSANTI / PUSH-BUTTON

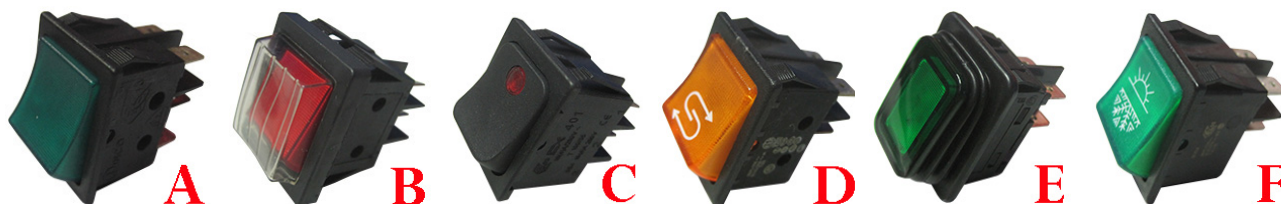

S&P CODE	TYPE	DIMENSIONI DIMENSIONS	POLI POLES	V	COLORE COLOR	S&P CODE	TYPE	DIMENSIONI DIMENSIONS	POLI POLES	V	COLORE COLOR
1108002	A	22X30mm	4	230V	GIALLO YELLOW	1108141	E	22X30mm	4	230V	VERDE GREEN
1108032	A	22X30mm	4	230V	VERDE GREEN	1108025	F	22X30mm	4	230V	
1108136	A	22X30mm	5	230V	GIALLO YELLOW	1108072	F	22X30mm	6	230V	
1108134	A	22X30mm	6	230V	VERDE GREEN	1108079	F	22X30mm	4	230V	
1108145	A	22X30mm	2	230V	NON LUMINOSO NERO BLACK SWITCH NOT LUMINOUS	1108083	F	22X30mm	2	230V	
1108076	B	22X30mm	3	230V	ROSSO RED	1108080	F	22X30mm	4	230V	
1108143	C	22X30mm	4	230V	ROSSO RED	1108146	F	22X30mm	6	230V	
1108185	D	22X30mm	4	230V	ARANCIO ORANGE						

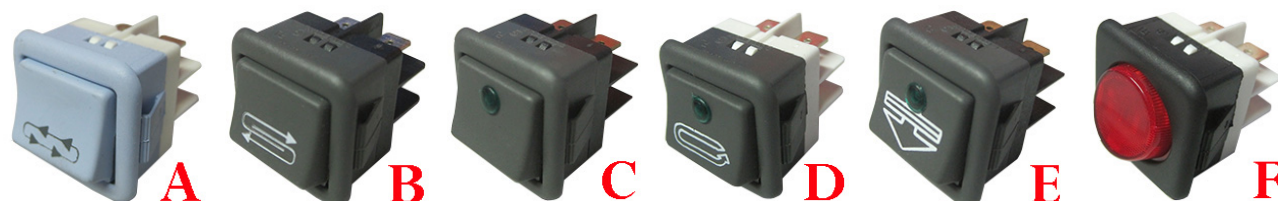

S&P CODE	TYPE	DIMENSIONI DIMENSIONS	POLI POLES	V	COLORE COLOR	S&P CODE	TYPE	DIMENSIONI DIMENSIONS	POLI POLES	V	COLORE COLOR
1108020	A	25X25mm	4	230V	AZZURRO BLUE	1108071	C	25X25mm	6	230V	VERDE GREEN
1108075	A	25X25mm	4	230V	GRIGIO GREY	1108078	D	25X25mm	6	230V	VERDE GREEN
1108084	A	25X25mm	6	230V	GRIGIO CHIARO LIGHT GREY	1108061	E	25X25mm	6	230V	VERDE GREEN
1108081	B	25X25mm	4	230V	AZZURRO BLUE	1108122	F	25X25mm	4	230V	ROSSO RED
1108082	B	25X25mm	4	230V	GRIGIO GREY	1108074	C	25X25mm	6	24V	VERDE GREEN



S&P CODE	TYPE	DIMENSIONI DIMENSIONS	POLI POLES	V	COLORE COLOR	S&P CODE	TYPE	DIMENSIONI DIMENSIONS	POLI POLES	V	COLORE COLOR
1108070	A	25X25mm	4	230V	ARANCIO ORANGE	1108005	E	12X34mm	4	250V	ARANCIO ORANGE
1108073	B	25X25mm	6	230V	BIANCO WHITE	1108178	F	Ø=15mm	2	250V	NERO BLACK
1108077	B	25X25mm	6	230V	VERDE GREEN	1108191	F	Ø=15mm	2	250V	NERO BLACK
1108040	C	25X25mm	4	230V	ARANCIO ORANGE	1108039	B	25X25mm	6	24V	VERDE GREEN
1108004	D	12X34mm	4	250V	ARANCIO ORANGE	1108049	C	25X25mm	4	24V	ARANCIO ORANGE

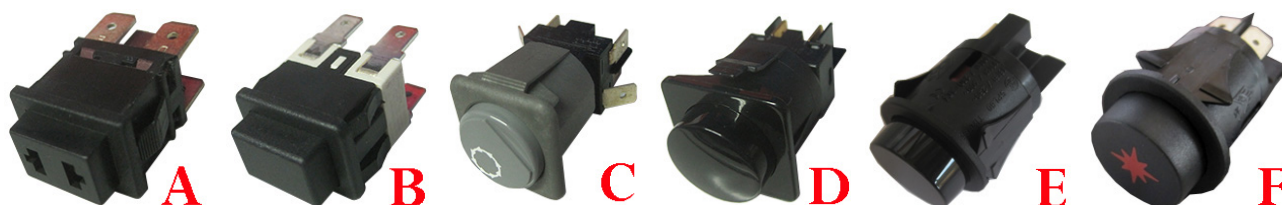

S&P CODE	TYPE	DIMENSIONI DIMENSIONS	POLI POLES	V	COLORE COLOR	S&P CODE	TYPE	DIMENSIONI DIMENSIONS	POLI POLES	V	COLORE COLOR
1108008	A	13X20mm	4	230V	NERO BLACK	1108033	D	25X25mm	4	230V	NERO BLACK
1108097	B	13X20mm	4	230V	NERO BLACK	1108158	E	Ø=25mm		250V	NERO BLACK
1108041	C	25X25mm	6	230V	GRIGIO GREY	1108159	F	Ø=25mm		250V	NERO BLACK

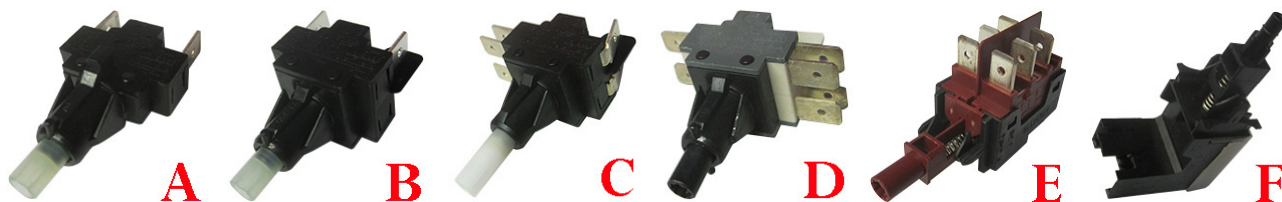

S&P CODE	TYPE	DIMENSIONI DIMENSIONS	POLI POLES	V	S&P CODE	TYPE	DIMENSIONI DIMENSIONS	POLI POLES	V
1108057	A	19X24mm	2	230V	1108067	D	19X24mm	6	230V
1108058	B	19X24mm	4	230V	1108068	E	19X30mm	6	230V
1108123	C	19X24mm	6	230V	1105394	F	18X29mm		20V

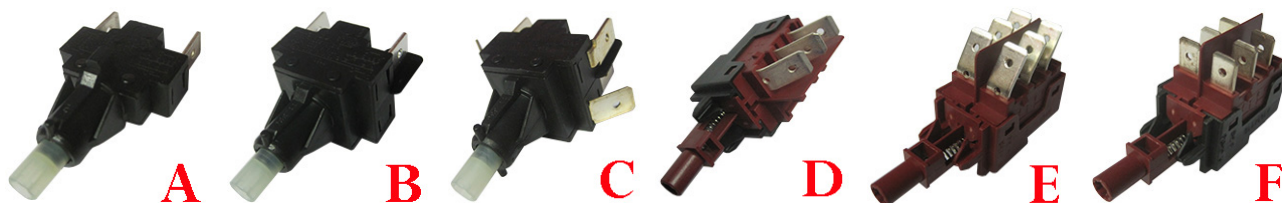

S&P CODE	TYPE	DIMENSIONI DIMENSIONS	POLI POLES	V	S&P CODE	TYPE	DIMENSIONI DIMENSIONS	POLI POLES	V
1105117	A	19X24mm	2	230V	1105389	D	19X30mm	3	230V
1105154	B	19X24mm	4	230V	1105245	E	19X30mm	6	230V
1105155	C	19X24mm	6	230V	1105170	F	19X30mm	6	230V
1105169	C	19X24mm	6 ORIZZONTALI 6 HORIZONTAL	230V					

TASTI / BUTTON

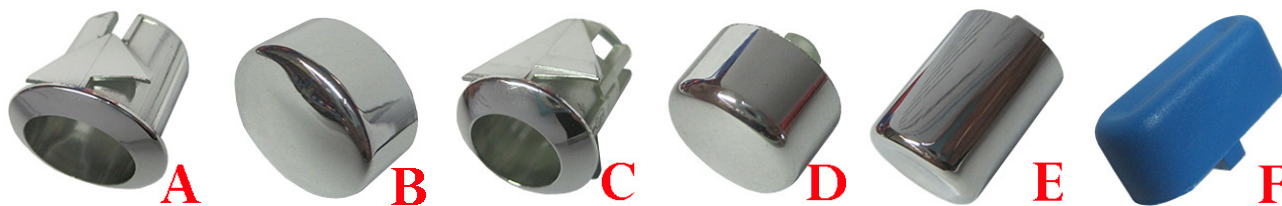

S&P CODE	TYPE	DIMENSIONI DIMENSIONS	COLORE COLOR	S&P CODE	TYPE	DIMENSIONI DIMENSIONS	COLORE COLOR
1105145	A	Ø=16mm	NERO BLACK	1105149	C	Ø=16mm	NERO BLACK
1105147	A	Ø=16mm	CROMATO CHROMIUM	1105151	C	Ø=16mm	CROMATO CHROMIUM
1105401	A	Ø=16mm	ARGENTO SILVER	1105297	C	Ø=16mm	CROMATO CHROMIUM
1105388	A	Ø=16mm	GRIGIO GREY	1105177	D	Ø=12mm	GRIGIO GREY
1105146	B	13X17mm	NERO BLACK	1105150	D	Ø=12mm	NERO BLACK
1105402	B	13X17mm	NERO OPACO MATT BLACK	1105152	D	Ø=12mm	CROMATO CHROMIUM
1105148	B	13X17mm	CROMATO CHROMIUM	1105296	D	Ø=12mm	CROMATO CHROMIUM
1108181	B	13X17mm	GRIGIO GREY	1105210	E	Ø=12mm	CROMATO CHROMIUM
1105176	C	Ø=16mm	GRIGIO GREY	1108116	F	10X25mm	BLU BLUE

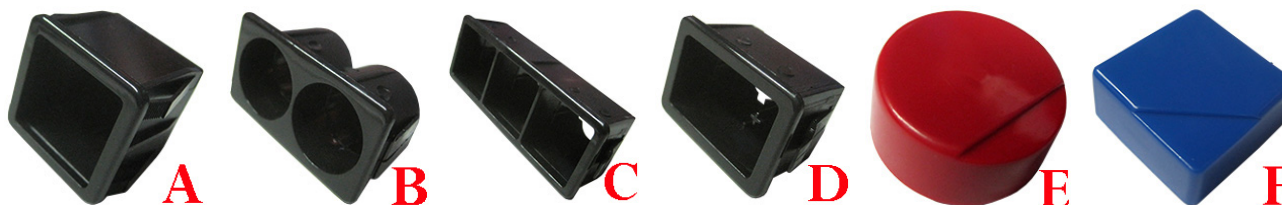

S&P CODE	TYPE	DIMENSIONI DIMENSIONS	COLORE COLOR	S&P CODE	TYPE	DIMENSIONI DIMENSIONS	COLORE COLOR
1105118	A	TASTO TONDO ROUND BUTTON	NERO BLACK	1105127	E	Ø=23mm	VERDE GREEN
1105119	A	TASTO QUADRATO SQUARE BUTTON	NERO BLACK	1105128	E	Ø=23mm	GIALLO YELLOW
1105120	B	TASTO TONDO ROUND BUTTON	NERO BLACK	1105175	E	Ø=23mm	GRIGIO GREY
1105121	B	TASTO QUADRATO SQUARE BUTTON	NERO BLACK	1105134	F	23X23mm	NERO BLACK
1105122	C	TASTO TONDO ROUND BUTTON	NERO BLACK	1105135	F	23X23mm	ROSSO RED
1105123	C	TASTO QUADRATO SQUARE BUTTON	NERO BLACK	1105136	F	23X23mm	BLU BLUE
1105226	D	TASTO RETTANGOLARE RECTANGULAR BUTTON	NERO BLACK	1105137	F	23X23mm	VERDE GREEN
1105124	F	Ø=23mm	NERO BLACK	1105138	F	23X23mm	GIALLO YELLOW
1105125	E	Ø=23mm	ROSSO RED				
1105126	E	Ø=23mm	BLU BLUE				

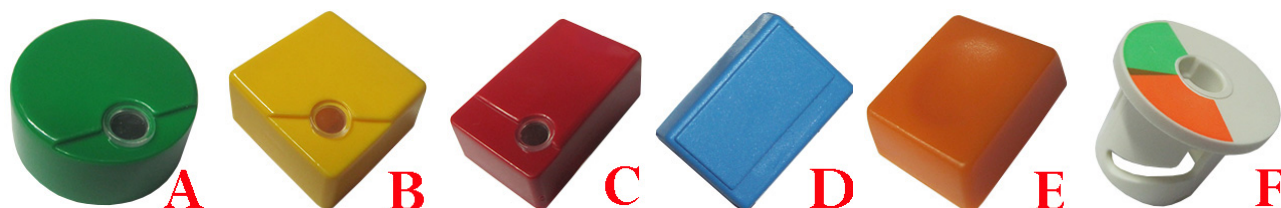

S&P CODE	TYPE	DIMENSIONI DIMENSIONS	COLORE COLOR	S&P CODE	TYPE	DIMENSIONI DIMENSIONS	COLORE COLOR
1105129	A	Ø=23mm	NERO BLACK	1105227	C	18X30mm	NERO BLACK
1105130	A	Ø=23mm	ROSSO RED	1105228	C	18X30mm	VERDE GREEN
1105131	A	Ø=23mm	BLU BLUE	1105229	C	18X30mm	ROSSO RED
1105132	A	Ø=23mm	VERDE GREEN	1105230	C	18X30mm	BLU BLUE
1105133	A	Ø=23mm	GIALLO YELLOW	1105231	C	18X30mm	GIALLO YELLOW
1105139	B	23X23mm	NERO BLACK	1105294	D	21X31mm	BLU BLUE
1105140	B	23X23mm	ROSSO RED	1108130	E	19X25mm	ARANCIO ORANGE
1105141	B	23X23mm	BLU BLUE	1105144	F	VERDE/ARANCIO PER DOMINO TONDO/QUADRO GREEN/ORANGE FOR ROUND/SQUARE DOMINO	
1105142	B	23X23mm	VERDE GREEN	1105232	F	VERDE/ARANCIO PER DOMINO RETTANGOLARE GREEN/ORANGE FOR RECTANGUL. DOMINO	
1105143	B	23X23mm	GIALLO YELLOW				



S&P CODE	TYPE	DIMENSIONI DIMENSIONS	COLORE COLOR	S&P CODE	TYPE	DIMENSIONI DIMENSIONS	COLORE COLOR
1105251	A	Ø=21mm	NERO BLACK	1108173	E	Ø=25mm	GRIGIO GREY
1108092	B	Ø=21mm	NERO BLACK	1108179	E	Ø=23mm	ROSSO RED
1105252	C	Ø=21mm	BLU BLUE	1108118	E	Ø=25mm	VERDE GREEN
1108170	D	Ø=25mm	GRIGIO GREY	1108174	F	Ø=25mm	GRIGIO GREY
1108135	D	Ø=25mm	ARANCIO ORANGE	1108121	F	Ø=25mm	VERDE GREEN



S&P CODE	TYPE	DIMENSIONI DIMENSIONS	COLORE COLOR	S&P CODE	TYPE	DIMENSIONI DIMENSIONS	COLORE COLOR
1108175	A	Ø=25mm	GRIGIO GREY	1108182	D	Ø=25mm	ARANCIO ORANGE
1108119	A	Ø=25mm	BLU BLUE	1108189	D	Ø=23mm	GRIGIO GREY
1108176	B	Ø=25mm	GRIGIO GREY	1108111	E	Ø=25mm	GRIGIO GREY
1108177	C	Ø=25mm	GRIGIO GREY	1108117	E	Ø=25mm	ARANCIO ORANGE
1108165	C	Ø=25mm	ARANCIO ORANGE	1108042	F	Ø=23mm	VERDE GREEN

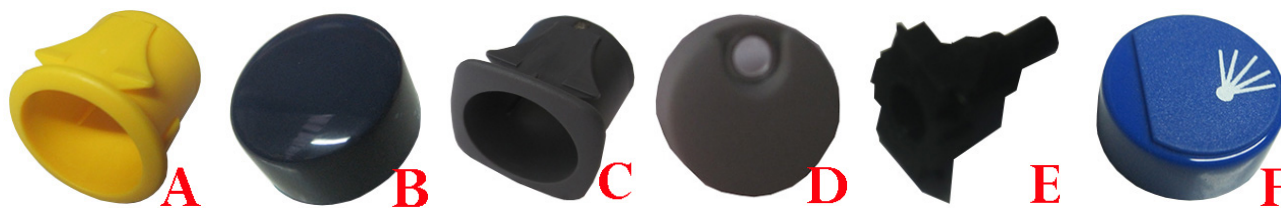

S&P CODE	TYPE	DIMENSIONI DIMENSIONS	COLORE COLOR	S&P CODE	TYPE	DIMENSIONI DIMENSIONS	COLORE COLOR
1105376	A	Ø=25mm	GIALLO YELLOW	1105341	D	Ø=21mm	GRIGIO GREY
1108093	A	Ø=25mm	LILLA	1108132	E	SUPPORTO TASTO DOMINO Ø=25mm SUPPORT BUTTON DOMINO Ø=25mm	
1105377	B	Ø=21mm	BLU BLUE	1108043	F	Ø=23mm	BLU BLUE
1105342	C	Ø=25mm	GRIGIO GREY				

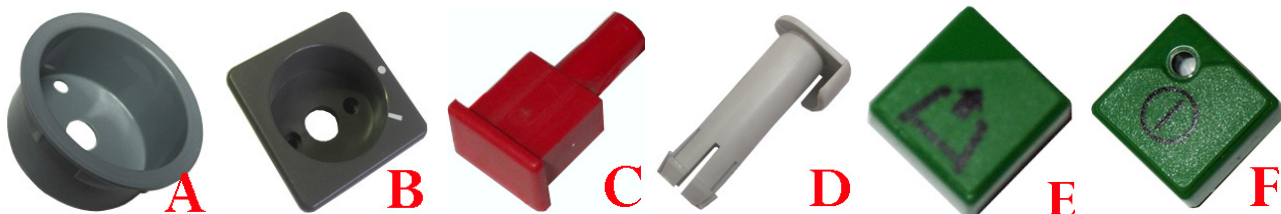

S&P CODE	TYPE	COLORE COLOR	S&P CODE	TYPE	DIMENSIONI DIMENSIONS	COLORE COLOR
4115155	A	GRIGIO GREY	1108019	D		GRIGIO GREY
4120347	B	GRIGIO GREY	1105272	E	23X23mm	VERDE GREEN
1108059	C	ROSSO RED	1105273	F	23X23mm	VERDE GREEN

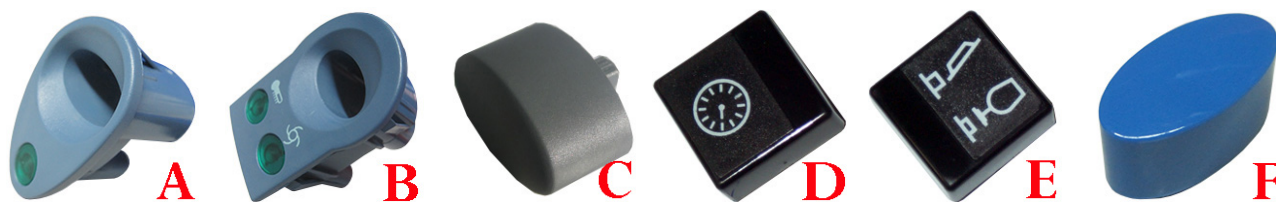

S&P CODE	TYPE	DIMENSIONI DIMENSIONS	COLORE COLOR	S&P CODE	TYPE	DIMENSIONI DIMENSIONS	COLORE COLOR
3108150	A	PER TASTO 13X23mm FOR BUTTON 13X23mm	BLU BLUE	3108145	C	13X23mm	
3108154	B	PER TASTO 13X23mm FOR BUTTON 13X23mm	BLU BLUE	3108146	C	13X23mm	
3108149	C	13X23mm	GRIGIO GREY	3108147	C	13X32mm	
3108142	C	13X23mm		1105274	D	23X23mm	NERO BLACK
3108143	C	13X32mm		1108038	E	23X23mm	NERO BLACK
3108155	C	13X23mm		1108110	F	11X21mm	BLU BLUE
3108144	C	13X23mm					



S&P CODE	TYPE	DIMENSIONI DIMENSIONS	COLORE COLOR	S&P CODE	TYPE	DIMENSIONI DIMENSIONS	COLORE COLOR
1104251	A	Ø=10mm	NERO BLACK	1105362	D	Ø=20mm	ROSSO RED
1104252	B	Ø=10mm	NERO BLACK	1108094	E	9X61mm	GRIGIO GREY
1108171	C	ØFiletto=4mm Ø=22mm	NERO BLACK	1108095	F	27X80mm	BIANCO WHITE

1105017 INTERRUPT ORE SELETT. GIALLO SIL / YELLOW SWITCH SILANOS
905326:
SILANOS SRL

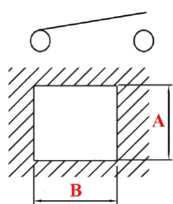
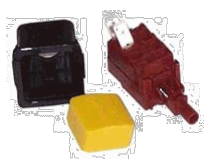

A = 20 mm, B = 31 mm

1105004 INTERRUPT ORE GENERALE SILANOS / MAIN SWITCH SILANOS
905348*:
SILANOS SRL

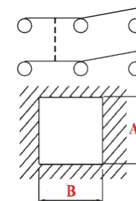
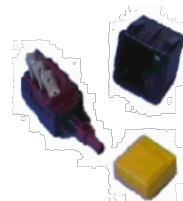

1105052 DEVIATOR
E UNIPOL.NERO
"LINEA" / "BLACK
ONEPOLAR SWITCH
"LINEA""
28784:
HOONVED - ALI SPA

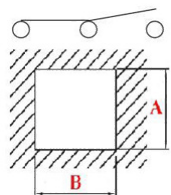

A=25mm, B=25mm

1105005 INTERRUTT
ORE M/A /
ON/OFF SWITCH SAB
PR90124**:
FABA SRL
9041044:
GRUPPO CIMBALI
Z100E063:
S.V. ITALIA SRL
EURO 2000

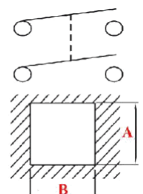

A= 25mm, B= 25mm

1105036 ACC.
TASTO
TONDO+SEGN+INT
BIPOLARE /
BIPOLAR SWITCH
ON/OFF

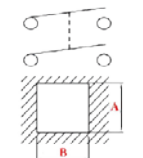

A=25mm, B= 25mm

1105078 INTERR.GE
NERALE TONDO 6POLI
/ ROUND MAIN
SWITCH COMENDA
H130460:
HOONVED - ALI SPA
130460:
COMENDA ALI SPA

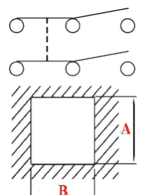

A=25mm, B=25mm

1105220 PULSANTIE
RA DOPPIA AL05D/07D
/ DOUBLE PUSH-
BUTTON
AL50D, AL54D,
AL55D: A.T.A. SRL



1108091 PULSANTIE
RA DOPPIA /
DOUBLE PUSH-
BUTTON
AL03, AL05, AL54,
AL55: A.T.A. SRL

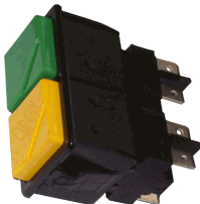

1105268 PULSANTIE
RA DOMINA 3 TASTI /
SWITCH DOMINA 3
PUSH-BUTTON
L2034: LUXIA SRL



1105219 PULSANTE
COMANDI
DECALCIFICATORE /
PUSH-BUTTON
AL31, AL35, AL41,
AL46; A.T.A. SRL

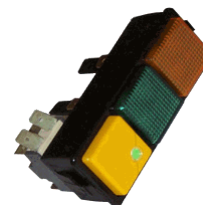

1105336 PULSANTE
RETTANGOLARE 3
POSIZIONI 83355 /
SWITCH
COMBINATION 3
FOLD
DEP81:
ELETTOBAR



1108022 PULSANTIE
RA COMANDI /
CONTROL PANEL
AL30, AL46, AL50,
AL60: A.T.A. SRL

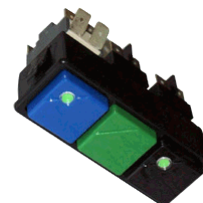

1105331 INTERRUTT
ORE ON/OFF - ON/OFF
BOILER /
SWITCH ON/OFF -
ON/OFF BOILER
103300: KRUPPS
S.R.L.



1114326 PULSANTIE
RA
START/RISCIACQUO /
MOMENTARY PUSH
BUTTON SWITCH
103320: KRUPPS
S.R.L.



1105369 PULSANTIE
RA ON-OFF PER
CAPOTTA /
SWITCH
COMBINATION CAPOT
103330: KRUPPS
S.R.L.

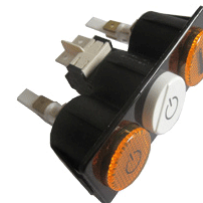

1105043 INTERRUTT
ORE LINEA PREPAR.
TONDO GRIGIO /
SWITCH 2-POLE GRAY
905348:
SILANOS SRL

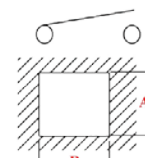

A = 25mm, B = 25mm

1105216 ASSIEME
INTERRUTTORE CM
SA / SWITCH CM SA
PASSPORT45.30,
PASSPORT50.32,
PASSPORT50.35:
ARISTARCO SPA

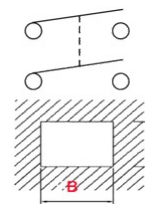

A = 20 mm, B = 25 mm

1105419 INTERRUTTORE CM BIPOLARE
ORE CM BIPOLARE
E0091 /
CM BIPOLAR SWITCH
E0091
PR50140: **FABA SRL**

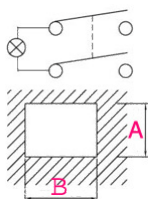

A=20mm, B=25mm

1105218 ASS. DEVIATORE CM D-D / SWITCH CM D-D
PROGAM 25CF/CR,
PROJET28EM,
GL4.32EM:
ARISTARCO SPA

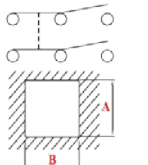

A = 20 mm, B = 25 mm

1132015 PULSANTE PIEZO CB / PIEZO PUSH-BUTTON CB
GIRARROSTI GAS
12-48P: **CB SRL**

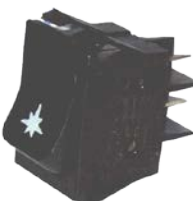

1105208 PULSANTE RETTANGOLARE START* / SWITCH "START"
9041016:
GRUPPO CIMBALI SPA

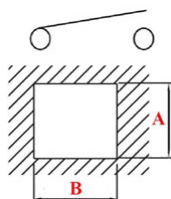

A = 23 mm, B = 33 mm

1105207 PULSANTE RETTANGOLARE GENERALE / MAIN SWITCH
9041014EX:
GRUPPO CIMBALI SPA

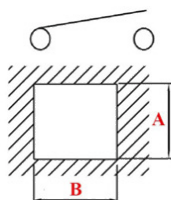
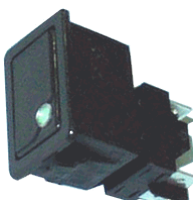

1108163 PULSANTIE RA 2 TASTI 102 /
20065: **ADLER**

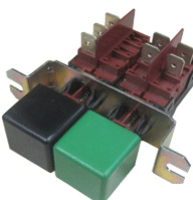

1108162 PULSANTIE RA 3 TASTI /
20064: **ADLER**

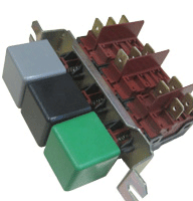

1105316 TESTA SELETT. 3 POSIZ. COMEPI / SELECTOR 3 POS. COMEPI
31420:
HOONVED - ALI SPA



1115070 SELETTORE LUMINOSO VERDE / GREEN OPERATION SWITCH
ED700:
HOONVED - ALI SPA



1105412 PTM/10 INTERRUTTORE EMERGENZA / PTM / 10 EMERGENCY SWITCH
RC916R0:
OEM ALI SPA



Ø=15mm

1105413 PTM/10 INTERRUTTORE START / PTM / 10 SWITCH START
RC913R0:
OEM ALI SPA



Ø=15mm

1115097 SELETTORE 1-2-3 3 POSIZIONI (DA M / 1-2-3 SWITCH 3-POSITION
CESC6284NT:
OMNIWASH SRL - SOCIETA' A SOCIO UNICO



1105095 SELETTORE 0-1 / SELECTOR 0-1
DW2000311:
DIHR-ALI SPA

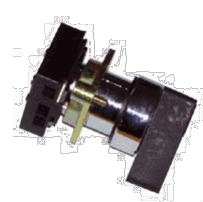

1105403 PUSH BUTTON SWITCH KIT / PUSH BUTTON SWITCH KIT
06063600:
SCOTSMAN ICE SRL



1115079 INTERRUTT
ORE MONOFASE /
ROTARY SWITCH
13186: **FABAR SRL**



1115034 SELETTORE
PROGRAMMI 4
POSIZIONI TIPO
NUOVO /
SELECTOR 4
POSITIONS NEW TYPE
3168190:
LASA SRL

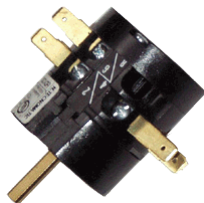

1115041 SELETTORE
C/F 3 POSIZIONI 3SB30
00-2EA11 /
COMMUTATOR C/F 3
POS. 3SB30 00-2EA11
CRO413380: **MARENO
INDUSTRIE ALI SPA**



1105014 SELETTORE
ATR ATA 13166 /
SWITCH ATR ATA
13166
13166:
A.T.A. SRL



1115017 SELETTORE
4 TEMPI 1-2-3-4 16A
DIHR / SELECTOR 4
TIME 1-2-3-4 16A DIHR
DW10300208:
DIHR-ALI SPA



1115018 SELETTORE
5 POSIZIONI /
SELECTOR 5
POSITIONS
DW80411:
DIHR-ALI SPA



1115022 SELETTORE
5 POS. LP2/3 /
SELECTOR 5
POSITIONS LP 2/3
DW80410:
DIHR-ALI SPA



1115020 SELETTORE
TEMP. 4 POS. 1-2-3-4
16A /
TEMPERATURE
SELECTOR 4
POSITIONS 1-2-3-4 16A
DW10300207:
DIHR-ALI SPA

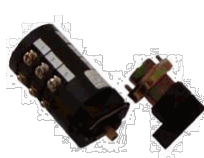

1105281 INTERRUTT.
CON FASTON X
FORNO / SWITCH
WITH FASTON FOR
OVEN
632: **ARISTARCO
SPA**

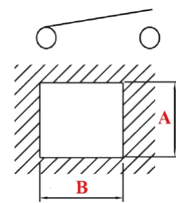

1105165 DEVIATOR
E BIPOLARE 1-0-2
LEVETTA 10 A /
BIPOLAR SWITCH 1-0-2
LEVER 10 A

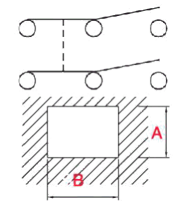

A = 20mm, B = 30mm

1105042 INTERRUTT
ORE MD RANCILIO /
SWITCH MD
RANCILIO
34030002:
RANCILIO SPA

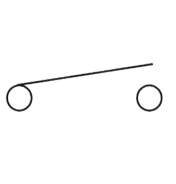

1105009 INTERRUTT
ORE BIPOLARE 16A
ATA /
BIPOLAR SWITCH 16A
A TA
7606: **A.T.A. SRL**



1105062 SELETTORE
GENERALE LOVATO
7GN209480U AC120 /
ROTARY SWITCH
7GN209480U AC120
7950: **A.T.A. SRL**



1105051 INTERRUTT
ORE COM. GR. CD /
SWITCH COM. GR. CD
34030006*:
RANCILIO SPA



1115011 COMMUTA
TORE 0-1 /
COMMUTATOR 0-1
34030026:
RANCILIO SPA



1115002 COMMUTATORE 2-0-1 LT /
COMMUTATOR 2-0-1
LT
34030027:
RANCILIO SPA



1105013 INTERRUTTORE BIPOLARE 16A /
BIPOLAR SWITCH 16A
25100102:
ELFRAMO SPA



1115080 INTERRUTTORE UNIPOLARE 12A /
ROTARY SWITCH 1
POLES 12A
25100001:
ELFRAMO SPA



1115081 INTERRUTTORE TRIPOLARE 16A /
ROTARY SWITCH 3
POLES 16A
25110001:
ELFRAMO SPA



1105300 INTERR. ROT. BIPOLARE /
BIPOLAR SWITCH
S000INA09QQQ:
MAZZER LUIGI SRL



1105275 INTERR. ROT. TRIPOLARE /
3POLAR SWITCH
S000INA04AQQ:
MAZZER LUIGI SRL



1105290 INTERR. ROT. BIPOL. + FASE AUS. /
BIPOLAR SWITCH.
S000INA13QQQ:
MAZZER LUIGI SRL



1115021 SELETTORE 0-1 SCH /
SWITCH 0-1 SCH
DW30009001:
DIHR-ALI SPA



1105027 INTERRUTTORE BIPOLARE B10-18-F /
BIPOLAR SWITCH B10-18-F
H120712:
HOONVED - ALI SPA
120712:
COMENDA ALI SPA



1105215 INTERRUTTORE QUADRIPOLORE 25A 500V /
SWITCH FOUR POLE 25A 500V
120736:
COMENDA ALI SPA



1105075 INTERR. QUADRIPOLORE 16A 3 POS. /
FOUR-POLAR SWITCH 16A 3 POSITIONS
120737:
COMENDA ALI SPA



1115102 COMMUTATORE QUADRATO 16AMP 614549 /
SWITCH 16AMP SQUARE 614 549
120715:
COMENDA ALI SPA



1115060 COMMUTATORE - COMMUTATOR /
COMMUTATOR
103590: KRUPPS
S.R.L.



1115045 SELETTORE 4CH 16(4)A-250V /
COMMUTATOR 4CH 16(4)A-250V
316810: LASA SRL



1115056 INTERRUTTORE QUADRIPOLORE 16A R708 /
ROTARY SWITCH 16A R708
213003:
ELETTOBAR DIVISIONE DELLA EUROTEC SRL



1105203 COMMUTATORE BIPOLARE
GYROS ELETTRICI CB
/
BIPOLAR
COMMUTATOR
GYROS CB
GYROS ELETTRICO:
CB SRL

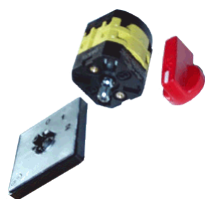

1115108 COMMUTATORE PER VAMPIRA /
SELECTOR SWITCH
13186B: FABAR SRL



1115047 COMMUTATORE 5 POSIZIONI
CSO128618202 / 5
POSITIONS
COMMUTATOR
CSO128618202
926182: MBM
926182:
ELETTROBAR
DIVISIONE DELLA
EUROTEC SRL



1105289 INTERRUTTORE BIPOLARE 16A /
BIPOLAR SWITCH 16A
161801:
EUROTEC SRL - DIV.
COOKING SERVICE
MBM
161801:
ELETTROBAR
DIVISIONE DELLA
EUROTEC SRL



1115054 INTERRUTTORE AF78-AF61 /
ROTARY SWITCH
7952: A.T.A. SRL



1105051 INTERRUTTORE COM. GR. CD /
SWITCH COM. GR. CD
34030006*:
RANCILIO SPA



1105197 INTERRUTTORE HF32 COMPLETO
DI PIATRINA /
SWITCH HF32
GIRAROSTI 20/96P:
CB SRL



1115031 INTERRUTTORE ROT. TRIPOLARE
+ FASE AUSILIARIA /
ROTARY SWITCH 4 - 3
OPERATING
POSITIONS
S000INA10AQQ:
MAZZER LUIGI SRL



1115087 INTERRUTTORE ESAPOLARE 2
POSIZIONE /
2 POSITION SWITCH
hexapolar
120722:
COMENDA ALI SPA



1105072 INTERRUTTORE ESAP.2
POS.B.V.S.HR /
SWITCH 2 POSIZIONI
B.V.S.HR
120734:
COMENDA ALI SPA

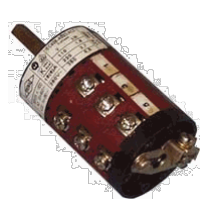

1105073 INTERRUTTORE ADRIPOLORE
16A.380V / FOUR-
POLAR SWITCH 16A
380V
120744:
COMENDA ALI SPA



1105025 INTERRUTTORE GENERALE AT /
MAIN SWITCH AT
9804: A.T.A. SRL



1115042 COMMUTATORE CS0128480041
(PER LAVASTOVIGLIE)
/ COMMUTATOR
CS0128480041
927034:
ELETTROBAR
927034: MBM



1115095 SELETTORE GENERALE AL DEP /
ROTARY SWITCH AL DEP
7951: A.T.A. SRL



1105074 INTERRUTTORE ESAP.15A 4 POS.
FC-A- /
SWITCH 15A 4
POSITIONS FC-A
120740:
COMENDA ALI SPA



1105077 COMMUTA
TORE ESAPOL.16 AMP.
/ SIX-POLAR
COMMUTATOR 16A
120716:
COMENDA ALI SPA



1115023 INTERR.
ETAP 4 SCATTI F 55-
80-65 /
ROTARY SWITCH 4
POSITIONS
120719:
COMENDA ALI SPA

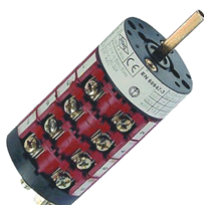

1115090 COMMUT.1-
0-2 25A RESISTENZA /
HEATING ELEMENT
COMMUTATOR
EH01000:
OEM ALI SPA



1105109 INTERRUTT
ORE OTTAPOLARE
16A 5 POS. /
COMMUTATOR 16A 5
POS.
120729:
COMENDA ALI SPA

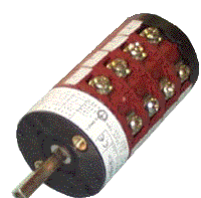

1105023 INTERRUTT
ORE OTTOPOLARE
16A 4P /
EIGHTPOLAR SWITCH
16A 4P
120728:
COMENDA ALI SPA



1109077 SELETTORE
11CH PER LC40AD /
SELECTOR 11CH PER
LC40AD
3168120:
LASA SRL



1105213 INTERRUTT
ORE CAFFE' C6/S C8/S /
"SWITCH ""COFFE""
C6/S C8/S"
10705414:
RANCILIO SPA
10705368:
RANCILIO SPA

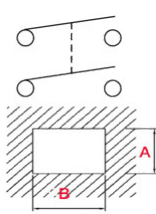
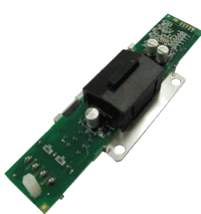

1105214 PULSANTIE
RA ACQUA C6 /
WATER PUSH-
BUTTON C6
10705369:
RANCILIO SPA

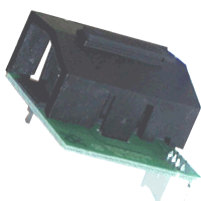

1105353 INTERRUTT
ORE ACQUA S /
KEYPAD UNIT
RANCILIO 1 BUTTON
10705366:
RANCILIO SPA

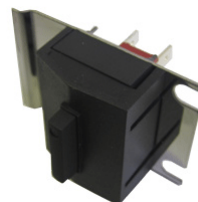

1105112 FASTON
FEMMINA 6,3X0,8
SEZ.1-2,5 OTTONE
STAGNATO /
FEMALE FASTON
6,3X0,8X SEZ. 1-2,5
TINNED BRASS



1105113 FASTON
MASCHIO 6,3X0,8
SEZ.1-2,5 OTTONE
STAGNATO /
MALE FASTON
6,3X0,8X SEZ. 1-2,5
TINNED BRASS



1105114 COPRIFAST
ON FEMMINA 6,3X0,8 /
FEMALE
COVERFASTON
6,3X0,8



1105115 COPRIFAST
ON MASCHIO 6,3X0,8 /
MALE COVERFASTON
6,3X0,8

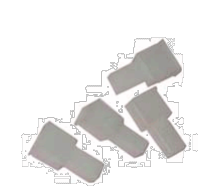

1105407 FASTON
FEMMINA
PREISOLATO
RINFORZATO 6,3X0,8
SEZIONE 2,5 OTTONE
STAGNATO /
PRE-INSULATING
REINFORCED FEMALE
FASTON 6,3x0,8
SECTION 2.5 TINNED
BRASS

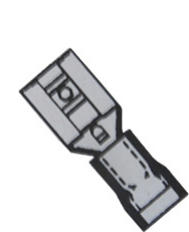

1105408 FASTON
MASCHIO
PREISOLATO
RINFORZATO 6,3X0,8
SEZIONE 2,5 OTTONE
STAGNATO /
MALE FASTON 6,3x0,8
REINFORCED PRE-
INSULATING SECTION
2.5 TINNED BRASS



1105409 FASTON
FEMMINA
TOTALMENTE
RINFORZATO
PREISOLATO 6,3X0,8
SEZ.2,5 OTTONE
STAGNATO /
FASTON FEMALE
FULLY REINFORCED
PRE-INSULATING
6,3x0,8 SEZ.2,5 TINNED
BRASS



1105410 CAPOCORD
A A FORCELLA
PREISOLATO 8,1X0,8
FORO 5,3 SEZIONE 2,5 /
TERMINALS FORK
PRE-INSULATING
8,1X0,8 HOLE SECTION
5.3 2.5



1105329 INTERRUTTI
ORE
PROGRAMMAZIONE A
CHIAVE /
SWITCH
22723022:
CMA MACCHINE PER
CAFFE' SRL



1105282 INTERRUTTI
ORE MAGNET.MG 32A
/
MAGNETIC
SWITCH.MG 32A
121022:
COMENDA ALI SPA



1105385 PORTAINTA
R. MOD. 1 DM. 25 INOX
X DO /
HOLDER-SWITCH
MOD. 1 DM. 25 STEEL
GMPI1D25RDP:
OMNIWASH SRL -
SOCIETA' A SOCIO
UNICO



1108001 PULSANTE
2 POLI VERDE /
CYCLE PUSH-BUTTON
SAB
9041024:
GRUPPO CIMBALI
SPA
Z100E064:
S.V. ITALIA SRL

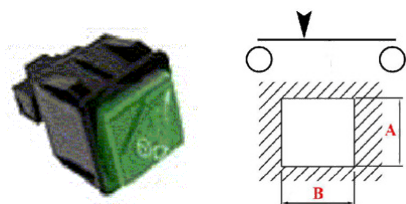

1108065 PULSANTE
UNIPOLARE ROSSO /
RED ONEPOLAR
PUSH-BUTTON
29473:
HOONVED - ALI SPA

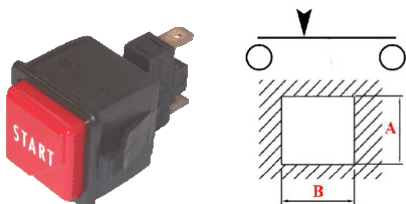

A = 25 mm, B = 28 mm

1108031 PULSANTE
UNIP.GRIGIO
ROT.GOF. / ROUND
GREY ONEPOLAR
PUSH BUTTON
29010:
HOONVED - ALI SPA
9041020:
GRUPPO CIMBALI
SPA

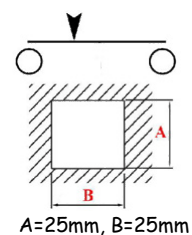

A=25mm, B=25mm

1108087 PULSANTE
QUADRO GENERALE /
MAIN PUSH-BUTTON
9041044*:
GRUPPO CIMBALI
SPA

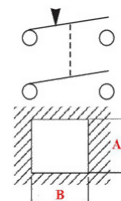

1108033 PULSANTE
BIPOLARE NERO
TASTO TONDO /
BLACK BIPOLAR
PUSH BUTTON
34030066:
RANCILIO SPA

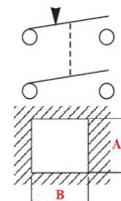

A=25mm, B=25mm

1108125 PULSANTE
DOPPIO FRUTTO
GRIGIO /
PUSH BUTTON 2-POLE
31185:
HOONVED - ALI SPA

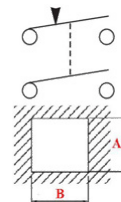

1108024 PULSANTE
PARTENZA CICLO /
START CYCLE PUSH
BUTTON
AF73, AF78, AF83,
AF88, AT95, AT96,
AT105; A.T.A. SRL

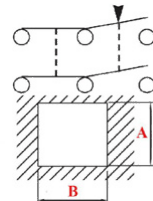

1108007 PULSANTE
GIALLO CICLO + RIG
+ RISC /
CYCLE+ RIG+
RINSING YELLOW
PUSH BUTTON
905324:
SILANOS SRL

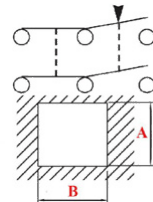

A = 19 mm, B = 30 mm

1108041 PULSANTE
TONDO CICLO
COMENDA /
ROUND CYCLE PUSH-
BUTTON COMENDA
H130459:
HOONVED - ALI SPA
130459:
COMENDA ALI SPA

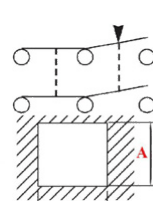

1108112 PULSANTE
DOMINO IPOS. CICLO
/ CYCLE PUSH-
BUTTON 1 POSITION
28160026:
ELFRAMO SPA

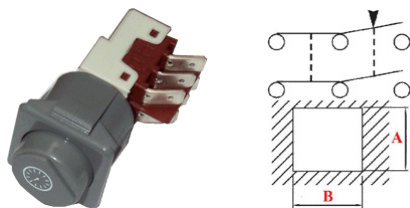

1108104 PULSANTE
AVVIO CICLO AL
20/25 / "SWITCH
""START CYCLE""
AL20/25"
6871: A.T.A. SRL

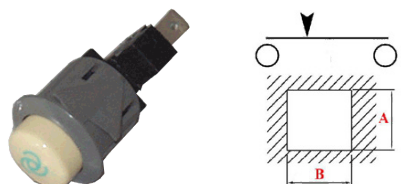

1108105 PULSANTE
RISCIACQUO FREDDO
AL 20/25 /
COLD RINSING PUSH
BUTTON AL 20/25
6876: A.T.A. SRL

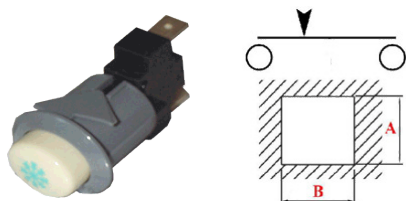

1108142 PULSANTE
AVVIAMENTO CICLO
/ START PUSH-
BUTTON
5811: A.T.A. SRL



1108090 ASS.
PULSANTE BIPOLARE
NA-NA /
BIPOLAR PUSH
BUTTON NA-NA
4702:
ARISTARCO SPA

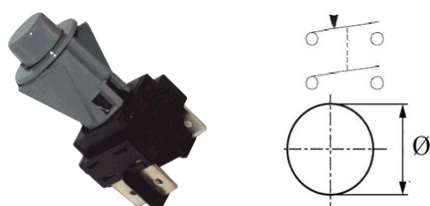

1108158 PULSANTE
TEMPORANEO
SP6014C1N0000 /
PUSH BUTTON
CR0410290:
SILKO ALI SPA
CR0410290:
MARENO
INDUSTRIE



1108159 PULSANTE
/
PUSH BUTTON
053978:
ELECTROLUX
PROFESSIONAL
S.P.A.



1108178 PULSANTI
MARCIA /
START BUTTON
EB076M: OBEL SRL



1108191 PULSANTI
DI REGOLAZIONE
(NERO) 0.7A 250V /
BLACK SINGLE POLE
PUSH-BUTTON 0.7A
250V
DF34: OBEL SRL

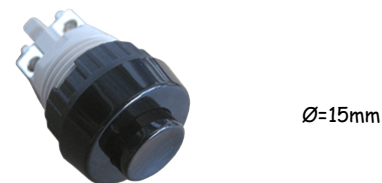

1108133 TESTA
PULSANTE "GIALLO"
(36871) /
PUSH-BUTTON
26934:
HOONVED - ALI SPA



1108128 K25 OFF
PUSH BUTTON /
K25 OFF PUSH
BUTTON
OD0364:
ELECTROLUX
PROFESSIONAL
S.P.A.



1108129 K25 PUKSE
PUSH BUTTON /
K25 PUKSE PUSH
BUTTON
OD0363:
ELECTROLUX
PROFESSIONAL
S.P.A.



1105096 PULSANTE
RASATO OPACO
BIANCO 3183 /
GREEN PUSH-BUTTON
3183
DW3002053:
DIHR-ALI SPA



1108167 PULSANTE
VERDE VELOCITA' 2 /
2 SPEED PUSH
BUTTON



1108099 PULSANTE
ARRESTO /
STOP PUSH-BUTTON
32W4000:
ANGELO PO
TR0328:
SILANOS SRL



1108101 PULSANTE
LUMINOSO VERDE
32W1730 /
GREEN PUSH-BUTTON
32W1730
32W1730:
ANGELO PO



1108137 PULSANTE
START COMPLETO /
START PUSH-BUTTON
COMPLETE
VR-RX-PULSTART:
VELOX BARCHITTA
S.R.L.



1115043 SELETTOR
E 0-1-2 COMPL. 1300 /
COMMUTATOR 0-1-2
1300
906210:
SILANOS SRL



1108048 PULSANTE
TIPO RT 10 /
PUSH-BUTTON RT10
130413:
COMENDA ALI SPA



1108169 PULSANTE
CICLO /
CYCLE PUSH BUTTON
13177: A.T.A. SRL



1108054 PULSANTE
RM122 VERDE /
GREEN PUSH BUTTON
RM122
130439: COMENDA
ALI SPA



1108168 PULSANTE
FUNGO ROSSO /
130426: COMENDA
ALI SPA



1108188 PULSANTE
ARRESTO A FUNGO
CON BLOCCO /
STOP BUTTON
MUSHROOM WITH
BLOCK



4115412 CONTATTO
MARCIA FAO GIALLO
/
CONTACTOR BLOCK
H130411:
HOONVED - ALI SPA
130411:
COMENDA ALI SPA
*: MBM



1108183 PULSANTE
/ BUTTON
0W3495:
ELECTROLUX
PROFESSIONAL
S.P.A.



1128042 CAVO FLAT
AL SOFT-TOUCH /
CABLE FLAT FOR
SOFT-TOUCH
8462: A.T.A. SRL



1114568 "PIATTINA
MULTIFILO ""F10p""
L=1000" /
FLAT MULTIWIRED
"F10p" "L = 1000"
DW50589:
DIHR-ALI SPA



1128028 ASS.
CAVETTI PER
CANDELE / IGNITION
CABLE
006023: ELECTROLUX
PROFESSIONAL
S.P.A.



1128029 CAVO FLAT
10 VIE X PULS.SOFT
TOUCH GET 5 /
RIBBON CABLE X
PULS.SOFT TOUCH
GET 5
211013:
ELETTROBAR



1128039 CAVO FLAT
10 VIE X
PULSANTIERA SOFT
TOUCH GET 5 /
CABLE FLAT 10 WAY X
PUSHBUTTONS SOFT
TOUCH GET 5
211011:
ELETTROBAR



1128026 CAVO COLLEGAMENTO PULSANTIERALG=2600 5X2VIE / CABLE CONNECTION PUSHBUTTON LG = 2600 5X2VIE
25190105:
ELFRAMO SPA



1114196 CAVO PIATTOXSCHEDA FC06-C-G / FLAT CABLE FC06-C-G
110482:
COMENDA ALI SPA
110482:
HOONVED - ALI SPA



1128037 CAVO DI COLLEGAMENTO STE / CONNECTING CABLE STE
37573:
HOONVED - ALI SPA



1128046 CAVO DI COLLEGAMENTO FLAT POTENZA/ CONSOLE L=120cm / CABLE FLAT L=120cm
103761: KRUPPS S.R.L.



1128044 FLAT SCHEDE DIGIT GICAR 550mm / FLAT P.C. BOARD GICAR 550mm
907215: SILANOS SRL



1114518 CONNETTO RE 5 POLI DI POTENZA(GET5) / 5-POLE POWER (get 5)
CN5:
ELETTROBAR DIVISIONE DELLA EUROTEC SRL



1114222 CONNETTO RE SCHEDE EL.4 P.+MORS / PCB CONNECTOR
RTFOC00593:
MBM- EUROTEC SRL - DIV. COOKING SERVICE



1128006 CAVO CON SPINA STAMP. SCHUKO 3X1 MT2 / CABLE WITH PLUG SCHUKO 3X1 MT2





1128007 CAVO CON SPINA SCHUKO 3X1,5 - 2000mm / CABLE WITH PLUG SCHUKO 3X1,5 - 2000mm





1128023 CAVO ELETTRICO SILICONE D. 2,5mm / SILICONE CABLE D. 2,5mm

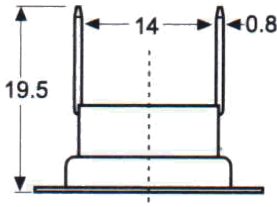
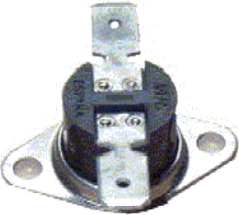
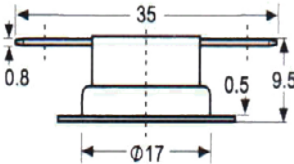

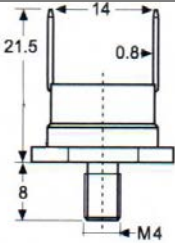
TERMOSTATI A CONTATTO / CONTACT THERMOSTATS

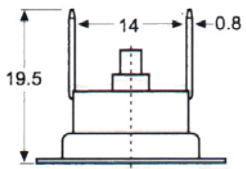
CODICE S&P S&P CODE	TEMPERATURA °C TEMPERATURE °C	SCHEDA TECNICA DATA SHEET	ADATTABILITA' ADAPTABILITY
			
1106237	60°C		LT35-22: ELETTOBAR
1106183	80°C		236048: ELETTOBAR
1106111	90°C		236052: ELETTOBAR
1106148	95°C		34200074: RANCILIO SPA 34200059: RANCILIO SPA
1106316	110°C		34200056: RANCILIO SPA
1106159	115°C		
1106149	130°C		
1106160	140°C		
1106150	155°C		
1106151	160°C		
1106152	165°C		
1106153	170°C		
1106154	175°C		
1106155	180°C		
			
1106289	55°C		L2061: LUXIA SRL
1106047	57°C		907123: SILANOS SRL
1106442	75°C		
1106740	100°C		
1106080	140°C		
			
1106481	95°C		
1106016	100°C		34200074: RANCILIO SPA
1106430	107°C		

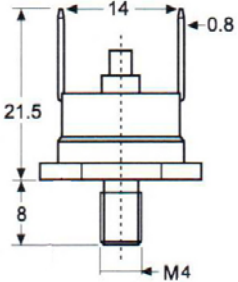
CODICE S&P S&P CODE	TEMPERATURA °C TEMPERATURE °C	SCHEDA TECNICA DATA SHEET	ADATTABILITA' ADAPTABILITY
1106017	135°C		34200075: RANCILIO SPA
1106432	125°C		
1106345	165°C		34200053: RANCILIO SPA
			
1106334	95°C		926189: ELETTOBAR 236047: ELETTOBAR
1106744	100°C		907245: SILANOS SRL
1106364	105°C		0300302: LAMBER
1106182	110°C		236039: ELETTOBAR
1106454	130°C		
			
1106483	145°C		
1106043	165°C		34200058: RANCILIO SPA

TERMOSTATI DI LAVORO MONOFASE / THERMOSTATS SINGLE PHASE



CODICE S&P S&P CODE	TEMPERATURA °C TEMPERATURE °C	N. POLI N. POLES	SCHEDA TECNICA DATA SHEET	CAPILLARE RICOPERTO CAPILLARY COVERED	ADATTABILITA' ADAPTABILITY
1106001	0-90°	3	A=Ø6,5X95mm B=1500mm	SI - YES	907110: SILANOS H120501: HOONVED 1106001: LASA T40-80-00005: VELOX BARCHITTA 808726ex: EMMEPI CETB85: OMNIWASH 34200047: RANCILIO 1106001: S.V. ITALIA 1106001: EURO 2000 1080: A.T.A. UNIVERSAL: ARISTARCO 120501: COMENDA 103345: KRUPPS
1106004	0-90°	3	A=Ø9,5x42mm B=1000mm	SI - YES	34200046: RANCILIO 120522: COMENDA
1106315	0-120°	3	A=Ø6X83mm B=900mm	NO	T40-80-00006: VELOX BARCHITTA
1106389	30-120°	3	A=Ø6X68mm B=1500mm	SI - YES	SL300099001: GBG
1106093	40-210°	3	A=Ø5X120 mm B=1500mm	SI - YES	



CODICE S&P S&P CODE	TEMPERATURA °C TEMPERATURE °C	N. POLI N. POLES	SCHEDA TECNICA DATA SHEET	CAPILLARE RICOPERTO CAPILLARY COVERED	ADATTABILITA' ADAPTABILITY
1106186	0-195°	3	A=Ø5X100 mm B=1500mm	NO	

TERMOSTATI DI LAVORO MONOFASE / THERMOSTATS SINGLE PHASE



CODICE S&P S&P CODE	TEMPERATURA °C TEMPERATURE °C	N. POLI N.POLES	SCHEDA TECNICA DATA SHEET	CAPILLARE RICOPERTO CAPILLARY COVERED	ADATTABILITA' ADAPTABILITY
1106072	0-90°	3	A=Ø6,5X100mm B=1500mm C=M16X1	SI-YES	00057150:ELFRAMO
1106005	30-90°	3	A=Ø6,5x95mm B=1000mm C=M14X1	NO	34200051RANCILIO

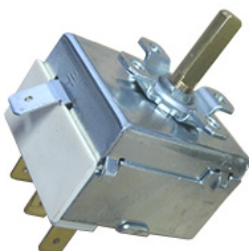

CODICE S&P S&P CODE	TEMPERATURA °C TEMPERATURE °C	N. POLI N.POLES	SCHEDA TECNICA DATA SHEET	CAPILLARE RICOPERTO CAPILLARY COVERED	ADATTABILITA' ADAPTABILITY
1106299	30-90°	3	A=Ø6X113mm B=2000mm	SI - YES	25417:HOONVED
1106725	30-90°	3	A=Ø6,5X95mm B=1000mm	SI - YES	4044: UNIVER-BAR



CODICE S&P S&P CODE	TEMPERATURA °C TEMPERATURE °C	N. POLI N.POLES	SCHEDA TECNICA DATA SHEET	CAPILLARE RICOPERTO CAPILLARY COVERED	ADATTABILITA' ADAPTABILITY
1106106	50-300°	3	A=Ø4X195mm B=1000mm	NO	Z300E003:S.V. ITALIA

TERMOSTATI DI LAVORO MONOFASE / THERMOSTATS SINGLE PHASE

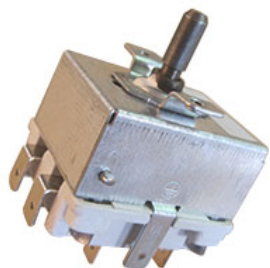

CODICE S&P S&P CODE	TEMPERATURA °C TEMPERATURE °C	N. POLI N.POLES	SCHEDA TECNICA DATA SHEET	CAPILLARE RICOPERTO CAPILLARY COVERED	ADATTABILITA' ADAPTABILITY
1106201	P1-1=46-85° P2-2=37-76°	6	A=Ø7X95mm B=950mm	SI - YES	H120525: HOONVED BC25-BC30-C95-C155- FC-LB-LBR-LF: COMENDA



CODICE S&P S&P CODE	TEMPERATURA °C TEMPERATURE °C	N. POLI N.POLES	SCHEDA TECNICA DATA SHEET	CAPILLARE RICOPERTO CAPILLARY COVERED	ADATTABILITA' ADAPTABILITY
1106008	55°	3	A=Ø6,5x95mm B=1000mm	SI - YES	1106008: S.V. ITALIA CETV55: OMNIWASH
1106010	90°	3	A=Ø6,5X95mm B=1500mm	SI - YES	22180004: ELFRAMO 0300005: LAMBER DW10707/1: DIHR 120530: COMENDA 907120: SILANOS AL03, AL05, AL10, AL26, AL54, AL55, AL40, AL46: A.T.A. 929107: ELETTROBAR UNIVERSALE: ARISTARCO 14197: FABAR
1106756	0-90°	3	A=Ø9,4X49mm B=1000mm	SI - YES	120533: HOONVED

TERMOSTATI DI LAVORO MONOFASE / THERMOSTATS SINGLE PHASE



CODICE S&P S&P CODE	TEMPERATURA °C TEMPERATURE °C	N. POLI N.POLES	SCHEDA TECNICA DATA SHEET	CAPILLARE RICOPERTO CAPILLARY COVERED	ADATTABILITA' ADAPTABILITY
1106124	83°	3	A=Ø6,5X115 mm B=620mm	SI - YES	CMT520:ELETTROBAR

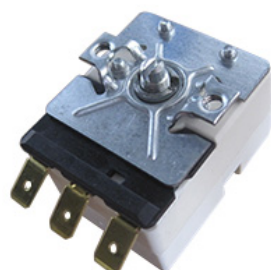

CODICE S&P S&P CODE	TEMPERATURA °C TEMPERATURE °C	N. POLI N.POLES	SCHEDA TECNICA DATA SHEET	CAPILLARE RICOPERTO CAPILLARY COVERED	ADATTABILITA' ADAPTABILITY
1106373	29-83°	3	A=Ø6X115mm B=870mm	SI - YES	0L2122:ELECTROLUX
1106399	30-90°	3	A=Ø6X114mm B=880mm	SI - YES	0L1633, 068582, 068012: ELECTROLUX

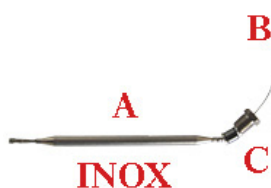
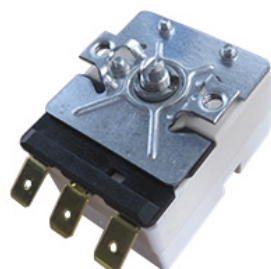

CODICE S&P S&P CODE	TEMPERATURA °C TEMPERATURE °C	N. POLI N.POLES	SCHEDA TECNICA DATA SHEET	CAPILLARE RICOPERTO CAPILLARY COVERED	ADATTABILITA' ADAPTABILITY
1106747	30-93°	3	A=Ø6X95mm B=1750mm C=M9X1	NO	3125010, 3125013: WINTERHALTER

TERMOSTATI DI LAVORO MONOFASE / THERMOSTATS SINGLE PHASE



CODICE S&P S&P CODE	TEMPERATURA °C TEMPERATURE °C	N. POLI N.POLES	SCHEDA TECNICA DATA SHEET	CAPILLARE RICOPERTO CAPILLARY COVERED	ADATTABILITA' ADAPTABILITY
1106012	50°	3	A=Ø17X48mm B=600mm C=21mm	SI - YES	1106012:BRASILIA 907124: SILANOS
1106352	50°	3	A=Ø14X32mm B=600mm C=22mm	SI - YES	926196:ELETTROBAR
1106090	53°	3	A=Ø14X32mm B=1000mm C=22mm	SI - YES	46101500:MODULAR D236023:GIGA GRANDI CUCINE 236042:ELETTROBAR 236042:EUROTEC
1106081	60°	3	A=Ø17X48mm B=610mm C=21mm	SI - YES	00057151:ELFRAMO



CODICE S&P S&P CODE	TEMPERATURA °C TEMPERATURE °C	N. POLI N.POLES	SCHEDA TECNICA DATA SHEET	CAPILLARE RICOPERTO CAPILLARY COVERED	ADATTABILITA' ADAPTABILITY
1106743	0-87°	3	A=Ø6X96mm B=1500mm	SI - YES	120534: HOONVED 120534: COMENDA
1106232	0-90°	3	A=Ø6X98 mm B=1500mm	SI - YES	984108000: GRUPPO CIMBALI DW107071: DIHR



CODICE S&P S&P CODE	TEMPERATURA °C TEMPERATURE °C	N. POLI N.POLES	SCHEDA TECNICA DATA SHEET	CAPILLARE RICOPERTO CAPILLARY COVERED	ADATTABILITA' ADAPTABILITY
1106224	56°	3	A=Ø6,5X73mm B=1000mm	SI - YES	25421:HOONVED

**TERMOSTATI DI SICUREZZA MONOFASE /
SAFETY THERMOSTATS SINGLE PHASE**



CODICE S&P S&P CODE	TEMPERATURA °C TEMPERATURE °C	N. POLI N.POLES	SCHEDA TECNICA DATA SHEET	CAPILLARE RICOPERTO CAPILLARY COVERED	ADATTABILITA' ADAPTABILITY
1106029	110°	3	A=Ø5,5X130mm B=1000mm	NO	120519*:COMENDA 13121*: A.T.A.
1106037	50-110°	2	A=Ø6,5X95 mm B=1000mm	NO	H120519:HOONVED 3267100: LASA 120519: COMENDA 13121: A.T.A. 141197A: FABAR 907125: SILANOS
1106185	95-135°	3	A=Ø5,5X130mm B=1000mm	SI - YES	

**TERMOSTATI DI SICUREZZA MONOFASE /
SAFETY THERMOSTATS SINGLE PHASE**



CODICE S&P S&P CODE	TEMPERATURA °C TEMPERATURE °C	N. POLI N.POLES	SCHEDA TECNICA DATA SHEET	CAPILLARE RICOPERTO CAPILLARY COVERED	ADATTABILITA' ADAPTABILITY
1106401	90-110°	2	A=Ø6X95mm B=1500mm	SI - YES	DW2000430:DIHR
1106197	110°	2	A=Ø7X87mm B=1030mm	SI - YES	ED550:HOONVED
1106691	120°	2	A=Ø6,5X93mm B=1500mm	SI - YES	
1106234	130°	2	A=Ø6X60mm B=500mm	SI - YES	9041052:HEMERSON 984115000:GRUPPO CIMBALI



CODICE S&P S&P CODE	TEMPERATURA °C TEMPERATURE °C	N. POLI N.POLES	SCHEDA TECNICA DATA SHEET	CAPILLARE RICOPERTO CAPILLARY COVERED	ADATTABILITA' ADAPTABILITY
1106431	124°	3	A=Ø4x70mm B=900mm	SI - YES	20198EX: ADLER 20673: FABAR



1
2
RAME - COPPER



CODICE S&P S&P CODE	TEMPERATURA °C TEMPERATURE °C	N. POLI N.POLES	SCHEDA TECNICA DATA SHEET	CAPILLARE RICOPERTO CAPILLARY COVERED	ADATTABILITA' ADAPTABILITY
1106120	1°=105° 2°=0-87°	1°=4 2°=3	1°= A=Ø6,3X72mm B=420mm 2°= A=Ø6,5X97mm B=2000mm	SI - YES	38167:HOONVED

TERMOSTATI DI SICUREZZA MONOFASE / SAFETY THERMOSTATS SINGLE PHASE



CODICE S&P S&P CODE	TEMPERATURA °C TEMPERATURE °C	N. POLI N.POLES	SCHEDA TECNICA DATA SHEET	CAPILLARE RICOPERTO CAPILLARY COVERED	ADATTABILITA' ADAPTABILITY
1106340	70°	2	A=Ø7X60mm B=870mm	NO	NM62044300:CASTEL MAC 62044302:SCOTSMAN



CODICE S&P S&P CODE	TEMPERATURA °C TEMPERATURE °C	N. POLI N.POLES	SCHEDA TECNICA DATA SHEET	CAPILLARE RICOPERTO CAPILLARY COVERED	ADATTABILITA' ADAPTABILITY
1106205	105°	4	A=Ø6,3X72,5mm B=430mm	SI - YES	120536: HOONVED
1106200	110°	2	A=Ø6,2X74,7mm B=1500mm	SI - YES	120523: COMENDA
1106138	110°	4	A=Ø6,3X70,5mm B=1500mm	SI - YES	BHC_,FC54C:COMENDA



CODICE S&P S&P CODE	TEMPERATURA °C TEMPERATURE °C	N. POLI N.POLES	SCHEDA TECNICA DATA SHEET	CAPILLARE RICOPERTO CAPILLARY COVERED	ADATTABILITA' ADAPTABILITY
1106244	108°	4	A=1000mm	NO	STA-GOLOS04-PIZZA CB- FP-BAKE/CHEF:CB
1106247	108°	4	A=1000mm	NO	FP OLD MODEL:CB
1106135	165°	4	A=500mm	NO	34200093:RANCILIO
1106114	165°	2	A=500mm	NO	34200092:RANCILIO 180039: MAGISTER

TERMOSTATI DI LAVORO MONOFASE / THERMOSTATS SINGLE PHASE

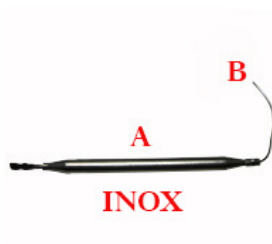

CODICE S&P S&P CODE	TEMPERATURA °C TEMPERATURE °C	N. POLI N. POLES	SCHEDA TECNICA DATA SHEET	CAPILLARE RICOPERTO CAPILLARY COVERED	ADATTABILITA' ADAPTABILITY
1106303	30-90°	2	A=Ø6X130mm B=2000mm	SI - YES	BN6A046050:OLIS
1106110	30-90°	2	A=Ø11X135mm B=1000mm		PRF0020: FABA
1106260	30-90°	3	A=Ø6X130mm B=1500mm	NO	MA7800300:MARENO
1106242	0-110°	2	A=Ø6X130mm B=900mm	SI - YES	ECV/SELF: CB
1106378	30-110°	3	A=Ø6X13 mm B=1000mm	NO	
1106273	135°	2	A=Ø6X75mm B=1500mm	SI - YES	



CODICE S&P S&P CODE	TEMPERATURA °C TEMPERATURE °C	N. POLI N. POLES	SCHEDA TECNICA DATA SHEET	CAPILLARE RICOPERTO CAPILLARY COVERED	ADATTABILITA' ADAPTABILITY
1106444	30-90°		A=Ø15X22,5mm B=1700mm	NO	

TERMOSTATI DI LAVORO MONOFASE / THERMOSTATS SINGLE PHASE



CODICE S&P S&P CODE	TEMPERATURA °C TEMPERATURE °C	N. POLI N. POLES	SCHEDA TECNICA DATA SHEET	CAPILLARE RICOPERTO CAPILLARY COVERED	ADATTABILITA' ADAPTABILITY
1106337	30-90°	3	A=Ø6X130mm B=2500mm C=M10X1	NO	32Z0160: ANGELO PO
1106386	30-90°	2	A=Ø6X130mm B=890mm C=M9X1	SI - YES	537001500 LOTUS 10140,0101403, SIR0101403: SILKO

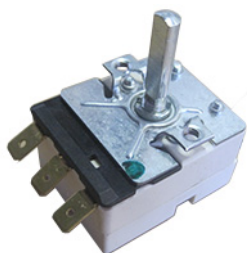

CODICE S&P S&P CODE	TEMPERATURA °C TEMPERATURE °C	N. POLI N. POLES	SCHEDA TECNICA DATA SHEET	CAPILLARE RICOPERTO CAPILLARY COVERED	ADATTABILITA' ADAPTABILITY
1106359	0-85°	3	A=Ø3,1X242mm B=1430mm	SI - YES	
1106336	30-90°	3	A=Ø6X130mm B=1000mm	SI - YES	
1106360	30-110°	3	A=Ø3,1X197mm B=3150mm	SI - YES	

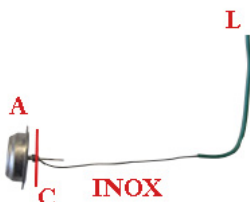
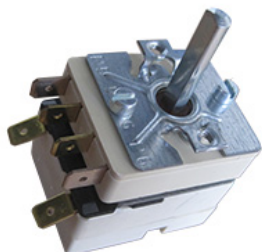

CODICE S&P S&P CODE	TEMPERATURA °C TEMPERATURE °C	N. POLI N. POLES	SCHEDA TECNICA DATA SHEET	CAPILLARE RICOPERTO CAPILLARY COVERED	ADATTABILITA' ADAPTABILITY
1106134	30-90	2+4	A=Ø23X10mm B=850mm C=31mm	SI - YES	32Z0410: ANGELO PO

**TERMOSTATI DI SICUREZZA MONOFASE /
SAFETY THERMOSTATS SINGLE PHASE**



CODICE S&P S&P CODE	TEMPERATURA °C TEMPERATURE °C	N. POLI N.POLES	SCHEDA TECNICA DATA SHEET	CAPILLARE RICOPERTO CAPILLARY COVERED	ADATTABILITA' ADAPTABILITY
1106732	125°	2	A=Ø6X77mm B=870mm	SI - YES	
1106470	140°	2	A=Ø3X226mm B=900mm	SI - YES	RTCP800067:EUROTEC

**TERMOSTATI DI SICUREZZA MONOFASE /
SAFETY THERMOSTATS SINGLE PHASE**



CODICE S&P S&P CODE	TEMPERATURA °C TEMPERATURE °C	N. POLI N.POLES	SCHEDA TECNICA DATA SHEET	CAPILLARE RICOPERTO CAPILLARY COVERED	ADATTABILITA' ADAPTABILITY
1106480	140°	2	A=Ø6X77mm B=1550mm	NO	

TERMOSTATI DI LAVORO TRIFASE / THERMOSTATS THREE PHASES

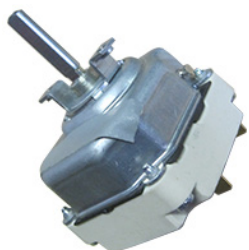

CODICE S&P S&P CODE	TEMPERATURA °C TEMPERATURE °C	N. POLI N.POLES	SCHEDA TECNICA DATA SHEET	CAPILLARE RICOPERTO CAPILLARY COVERED	ADATTABILITA' ADAPTABILITY
1106283	30-90°	6	A=Ø6X129mm B=1480mm C=M10X1	SI - YES	1037035000:MARENO
1106411	30-90°	6	A=Ø6X150mm B=1500mm C=M12X1	SI - YES	
1106410	30-110°	6	A=Ø6X160mm B=1500mm C=M9X1	SI - YES	
1106304	32-110°	9	A=Ø6X138mm B=3000mm C=M9X1	SI - YES	808058:EMMEPI GRANDI CUCINE
1106266	30-110°	6	A=Ø6X140mm B=1500mm C=M9X1	NO	

TERMOSTATI CON INTERRUETTORE TRIFASE / THERMOSTATS WITH SWITCH THREE PHASES



CODICE S&P S&P CODE	TEMPERATURA °C TEMPERATURE °C	N. POLI N.POLES	SCHEDA TECNICA DATA SHEET	CAPILLARE RICOPERTO CAPILLARY COVERED	ADATTABILITA' ADAPTABILITY
1106176	30-110°	6+6	A=Ø6X130mm B=1200mm	SI - YES	32V0060:ANGELO PO

**TERMOSTATI DI SICUREZZA TRIFASE /
SAFETY THERMOSTATS THREE PHASES**



CODICE S&P S&P CODE	TEMPERATURA °C TEMPERATURE °C	N. POLI N.POLES	SCHEDA TECNICA DATA SHEET	CAPILLARE RICOPERTO CAPILLARY COVERED	ADATTABILITA' ADAPTABILITY
1106298	118°	6	A=Ø6x78mm B=1000mm	SI - YES	22100002:ELFRAMO
1106406	135°		A=Ø3,1X225mm B= 900mm	SI - YES	RTCP900074:EUROTEC
1106233	140°	6	A=Ø4X126mm B=900mm	SI - YES	9041033:HEMERSON 984140000:GRUPPO CIMBALI 1037305000:MARENO
1106714	140°	7	A=Ø6X88mm B=900mm	SI - YES	LAR65070020:LAINOX
1106104	150°		A=Ø6X80mm B=1500mm	SI - YES	002711:ELECTROLUX
1106277	169°	6	A=Ø4X128mm B=900mm	SI - YES	34200095:RANCILIO
1106408	187°		A=Ø4X125mm B=1000mm	SI - YES	34200096:RANCILIO



CODICE S&P S&P CODE	TEMPERATURA °C TEMPERATURE °C	N. POLI N.POLES	SCHEDA TECNICA DATA SHEET	CAPILLARE RICOPERTO CAPILLARY COVERED	ADATTABILITA' ADAPTABILITY
1106335	135°	7	A=Ø6X80mm B=900mm C=M9X1	NO	MA1878900:SILKO 1878900:MARENO



CODICE S&P S&P CODE	TEMPERATURA °C TEMPERATURE °C	N. POLI N.POLES	SCHEDA TECNICA DATA SHEET	CAPILLARE RICOPERTO CAPILLARY COVERED	ADATTABILITA' ADAPTABILITY
1106033	170°	2	A=Ø3X155mm B=400mm	SI - YES	031482:ELECTROLUX

1106053 TERMOSTA
TO -35/+35 F/2000
MONOFASE -SENSORE
Ø 6,5X115mm
CAPILLARE 1500mm /
THERMOSTAT -35/+35
F/200 SINGLE PHASE -
SENSOR Ø 6,5X115mm
CAPILLARY 1500mm
80583002:
IRF- C&D-
FIOCCHETTI

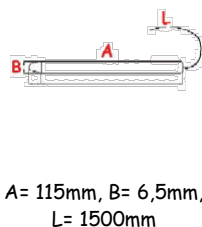

1106709 TERMOSTA
TO IM 0-90°C.TC/2
542564 /
THERMOSTAT 0-90 °
C.TC IM / 2 542564
120515:
COMENDA ALI SPA



1106424 KIT
TERMOSTATO DI
SICUREZZA /
SAFETY THERMOSTAT
KIT
120520:
COMENDA ALI SPA
H120520:
HOONVED - ALI SPA



1106326 KIT
TERMOSTATO
AUSILIARIO /
THERMOSTAT KIT
CM814533480:
CASTEL MAC SPA
CM81453348:
SCOTSMAN ICE SRL



1106015 TERMOSTA
TO 160°-190°
FRIGGITRICE A.PO
SENSORE Ø 20X126 mm
CAPILLARE 126mm /
FRYER THERMOSTAT
160°-190° A.PO SENSOR
Ø 20X126 mm
CAPILLARY 126mm
6300359:
ANGELO PO GRANDI

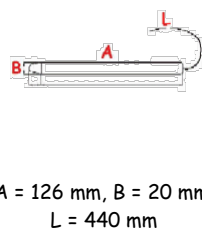

CUCINE SPA

1106146 TERMOMET
RO D. 52 0-120°
CAP.1500mm -
SENSORE Ø 6X40 mm
CAPILLARE 1500mm /
THERMOMETER D.52
0.120° CAP.1500mm
SENSOR Ø 6X40 mm
CAPILLARY 1500mm
1037104500:
MARENO INDUSTRIE
H450905:
HOONVED - ALI SPA
450905:
COMENDA ALI SPA

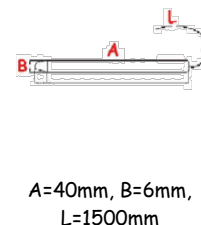

1106220 TELETERM
OMETRO 0-120°
D.60mm CAPILLARE
1500X6 /
THERMOMETER 0-120°
D.60mm 1500X6
00074420*:
ELFRAMO SPA
32100003*:
ELFRAMO SPA

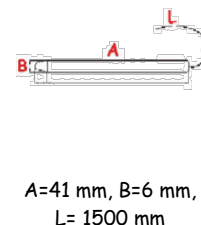

1106329 TERMOMET
RO D=60 0/120°C /
THERMOMETER D=60
0/120°C
32100003:
ELFRAMO SPA



1106191 TERMOMET
RO 0-350° D.60mm
CAPILLARE 1500X6 /
THERMOMETER 0-350°
D.60mm 1500X6

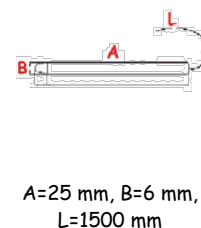

1106484 TERMOMET
RO D.52 +40/-40 /
THERMOMETER D.52
+40 / -40



1106472 TERMOMET
RO CIRCOLARE D.52
mm CPNF -40+40 /
D.52 ROUND
THERMOMETER -40
+40 mm CPNF



DIAMETER=52MM

1106210 TELETERM
OMETRO -40+40 D.60
CF72 /
THERMOMETER-40+40
D.60 CF72



A=50mm, B=6mm,
L=1500mm

1106195 TERMOREG
OLATORE 0-120°
72X72X1500 /
THERMOSTAT 0-120°
72X72X1500



A=57mm, B= 7mm,
L=1500mm

1106188 TERMOMET
RO 0-120° 58X25X1500 /
THERMOMETER 0-120°
58X25X1500

5693:

ARISTARCO KASTEL

1106188: EURO 2000

13725: A.T.A. SRL

CETEM:

OMNIWASH SRL

DW10500005:

DIHR-ALI SPA

4507:

UNIVER-BAR SRL

23236:

HOONVED - ALI SPA

9140214*:

GRUPPO CIMBALI SPA

32110003:

ELFRAMO SPA

977034000:

GRUPPO CIMBALI



1106196 TERMOMET
RO 0-120 CAP.3000mm
6,5X20 /
THERMOMETER 0-120
3000mm 6,5X20

14198: FABAR SRL

907090:

SILANOS SRL

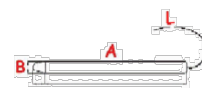

A=20 mm, B=7mm,
L=3000mm

1106323 TERMOMET
RO RETTANGOLARE P
43E-P 48E /
DISH-WASHER
THERMOMETER P 43E-
P 48E

DW10500011:

DIHR-ALI SPA

9131500:

GRUPPO CIMBALI SPA

5576:

ARISTARCO KASTEL

SPA

984124000:

GRUPPO CIMBALI



1106425 TERMOMET
RO PER PASSPORT
45.30-50.32-1040
62X11MM 20-130°C /
THERMOMETER FOR
PASSPORT 45.30-50.32-
1040 62X11MM 20-
130°C

5576:

ARISTARCO KASTEL

SPA



1106061 TERMOMET
RO DIG. FISS. CLIPS
DTE+ SCATOLA--
50+70°C /
CLIPS FASTENER
DIGITAL

THERMOMETER DTE

1188017:

MONDIAL GROUP

S.R.L.



1106077 TERMOMET
RO PER FREEZER -
50+70 /
REFRIGERATOR
THERMOMETER -50+70



1106025 TERMOMET
RO DIGITALE -50+260° /
DIGITAL
THERMOMETER
50+260°



1106204 TERMOMETRO PER FORNO / THERMOSTAT FOR OVEN



1106466 TERMOIGROMETRO ELETTRONICO CON MIN/MAX / THERMOIGROMETER



1106467 TERMOIGROMETRO CON SONDA INTERNO/ESTERNO / THERMOIGROMETER WITH INTERNAL/EXTERNAL PROBE



1106078 TERMOSTATO 100°C MONOFASE SICUREZZA 62/R / SAFETY THERMOSTAT 62/R 100° SINGLE PHASE

CESB454:
OMNIWASH SRL - SOCIETA' A SOCIO UNICO
4751:
UNIVER-BAR SRL

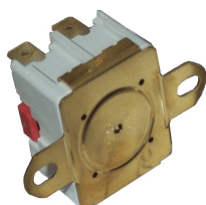

1106325 TERMOSTATO SICUR. VASCA 62/R BIPOLARE / BIPOLAR TANK SAFETY THERMOSTAT 62/R

CESV001:
OMNIWASH SRL - SOCIETA' A SOCIO UNICO



1106301 TERMOSTATO A CONTATTO VASCA/S. 200° (X5) / CONTACT TANK THERMOSTAT 200° (X5)

236053:
ELETTROBAR DIVISIONE DELLA EUROTEC SRL

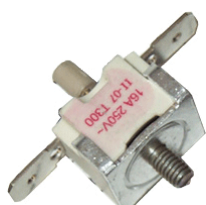

1106108 TERMOSTATO MONOFASE SICUREZZA AUTOMATICO 200° / AUTOMATIC SAFETY THERMOSTAT SINGLE PHASE

PR40026: FABA SRL



1106711 TERMOSTATO SICUREZZA PIASTRE 300° / THERMOSTAT SAFETY PLATES

907101: SILANOS SRL



1106394 *TERM.SIC. VASCA200ØLF60 236053 / TANK SAFETY THERMOSTAT 200°LF60 236053

RIC0003016:
MBM- EUROTEC SRL - DIV. COOKING SERVICE



1106249 TERMOSTATO VASCA FISSO IN DEVIAZIONE / STOKE THERMOSTAT

DW15551:
DIHR-ALI SPA



1106248 TERMOSTATO BIMET. PASSO 5 / STOKE THERMOSTAT

048804:
ELECTROLUX PROFESSIONAL S.P.A.



1106199 TERMOSTATO BIMETALLICO DOPPIO / DOUBLE BIMETALLIC THERMOSTAT

120524:
COMENDA ALI SPA 33948:
HOONVED - ALI SPA 120524:
HOONVED - ALI SPA

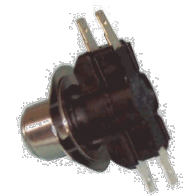

= 2102287

1106045 TERMOSTATO VASCA ZANUSSI 048487 / TANK THERMOSTAT ZANUSSI 048487

048487:
ELECTROLUX PROFESSIONAL S.P.A.



1106419 TERMOSTATO 56°C UNIPOLARE ELTH 262.0 / THERMOSTAT SINGLE PHASE UNIPOLARE ELTH 262.0 56°C

22180101:
ELFRAMO SPA



1106126 TERMOSTA
TO BIMETALLICO 2
CONTATTI LASA NO
35-46° / NC 52-60° /
THERMOSTAT 2
CONTACTS LASA NO
35-46° / NC 52-60°
3267420: LASA SRL
3267220: LASA SRL



1106309 TERMOSTA
TO 2
TEMP.9.248O.O1/130[/
THERMOSTAT 2
TEMP.9.248O.O1/130[



1106314 TERMOSTA
TO A CONTATTO
RIARMO MANUALE
110° /
THERMOSTAT
4280: A.T.A. SRL



1106707 TERMOSTA
TO A CONTATTO
82,5°C /
CONTACT
THERMOSTAT 82.5 °C
8602: A.T.A. SRL



1106141 TERMOSTA
TO 110°C SICUREZZA
CONTATTO KLIXON /
SAFETY
THERMOSTAT
CONTACT KLIXON
110°
DW15550:
DIHR-ALI SPA



1106139 PORTA
SONDA TERMOSTATO
/
HOLDER PROBE
THERMOSTAT
DW12510:
DIHR-ALI SPA



1106113 PORTA-
TERMOSTATO VASCA /
TANK THERMOSTAT
HOLDER
38123237:
RANCILIO SPA

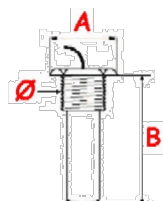

A=30mm B= 48mm,
Ø=20mm

1106726 Bulbo
portasonda termostato /
Bulb thermostat probe
holder
1503:
UNIVER-BAR SRL



GASKET=1106727

1106727 Guarnizione
portasonda Ø 10 /
Seal probe holder Ø 10
1504:
UNIVER-BAR SRL



2101031 GUARNIZIO
NE OR D. 37X5.33 /
O RING D.37 47X5.33
29938:
HOONVED - ALI SPA
103415: KRUPPS S.R.L.
36404015:
RANCILIO SPA
907981:
SILANOS SRL
456075:
ELETTOBAR
DIVISIONE DELLA
EUROTEC SRL

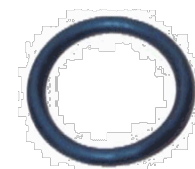

2101032 GUARNIZIO
NE OR D. 46 99X5.33 /
O RING D.46 99X5.33
H200820:
HOONVED - ALI SPA
2707069:
WINTERHALTER
ITALIA SRL
2188400: LASA SRL
DW13005:
DIHR-ALI SPA
067620:
ELECTROLUX
PROFESSIONAL
S.P.A.
REB456002:
LOTUS SPA
4207*: A.T.A. SRL
2662:
ARISTARCO SPA
456002:
ELETTOBAR
DIVISIONE DELLA
EUROTEC SRL
200820:
COMENDA ALI SPA
*:
EUROTEC SRL - DIV.
COOKING SERVICE
MBM
4011:
UNIVER-BAR SRL

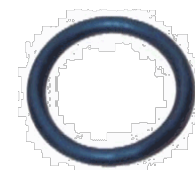

2101033 GUARNIZIO
NE OR D. 56 52X5.33 /
O RING D.56 52X5.33

H200815:
HOONVED - ALI SPA
0200041:
LAMBER DI AFFABA
FRANCESCO & C.
DW13015:
DIHR-ALI SPA
3150430:
ANGELO PO GRANDI
CUCINE SPA
200815:
COMENDA ALI SPA
103445:
KRUPPS S.R.L.
12010040:
FAGOR
INDUSTRIALE S.R.L.

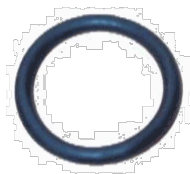

2101312 10,82X1,78
O-RING NBR /
O-RING NBR 10,82X1,78
60073: ADLER S.P.A.



2101318 18,77X1,78
O-RING NBR /
O-RING NBR
18,77X1,78
3150840:
ANGELO PO GRANDI
CUCINE SPA



2101485 47,23X3,53
O-RING NBR /
O-RING NBR 47,23X3,53
3152151:
ANGELO PO GRANDI
CUCINE SPA
3831:
UNIVER-BAR SRL
536009800: LOTUS
SPA



2101477 37,70X3,53
O-RING NBR /
O-RING NBR 37,70X3,53
4698:
ARISTARCO SPA
DW13022:
DIHR-ALI SPA



2101387 15,88X2,62
O-RING NBR / O-RING
NBR 15,88X2,62
93: ARISTARCO SPA
01471:
LA SPAZIALE SPA



2101321 23,52X1,78
O-RING NBR /
O-RING NBR 23,52X1,78
4643: A.T.A. SRL



2101470 26,57X3,53
O-RING NBR /
O-RING NBR 26,57X3,53
OR4106:
ANGELO PO GRANDI
CUCINE SPA



2101058 GUARNIZIO
NE OR X FLANGIA NBR
/
OR FOR HEATING
HELEMENT
57: ARISTARCO SPA



2101407 40,95X2,62
O-RING NBR /
O-RING NBR 40,95X2,62
20429:
BREMA ICE MAKERS
SPA



2101385 15,08X2,62
O-RING NBR /
O-RING NBR 15,08X2,62
12303:
CMA MACCHINE PER
CAFFE' SRL
*:
EUROTEC SRL - DIV.
COOKING SERVICE
MBM
456045:
ELETTROBAR
DIVISIONE DELLA
EUROTEC SRL



2101406 39,35X2,62
O-RING NBR /
O-RING NBR 39,35X2,62
12300000:
CMA MACCHINE PER
CAFFE' SRL
32243:
HOONVED - ALI SPA
DW13006:
DIHR-ALI SPA
3337:
UNIVER-BAR SRL



2101398 26,65X2,62
O-RING NBR /
O-RING NBR 26,65X2,62
200805:
COMENDA ALI SPA
2250001302:
UGOLINI SPA



2101596 81,92X5,34
O-RING NBR /
O-RING NBR 81,92X5,34
200829:
COMENDA ALI SPA



2101716 63,50X3,53
O-RING NBR /
O-RING NBR
63,50X3,53
200853:
COMENDA ALI SPA



2101132 GUARNIZIO
NE OR 2X9,5X13,5 F.S. /
O-RING 2X9,5X13,5 F.S.
200844:
COMENDA ALI SPA



2101539 183,75X3,53
O-RING NBR /
O-RING NBR
183,75X3,53
200828:
COMENDA ALI SPA



2101332 41,00X1,78
O-RING NBR /
O-RING NBR 41,00X1,78
200833:
COMENDA ALI SPA



2101151 GUARN.OR
3X6X12 /
O-RING 3X6X12
200854:
COMENDA ALI SPA



2101572 37,30X3,60
O-RING NBR /
O-RING NBR 37,30x3,60
200830:
COMENDA ALI SPA



2101152 GUAR. OR
81X87X3 /
O-RING 81X87X3
200856:
COMENDA ALI SPA



2101153 GUAR. OR
43X49X3 /
O-RING 43X49X3
200855:
COMENDA ALI SPA

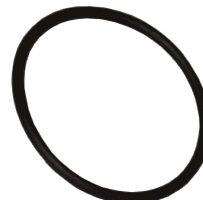

2101464 18,64X3,53
O-RING NBR /
O-RING NBR 18,64X3,53
DW60377:
DIHR-ALI SPA



2101118 OR 37X1,5 /
O-RING 37X1,5
DW89332:
DIHR-ALI SPA



2101119 OR 58X1,5 /
O-RING 58X1,5
DW89331:
DIHR-ALI SPA



2101319 20,35X1,78
O-RING NBR /
O-RING NBR 20,35X1,78
DW13018:
DIHR-ALI SPA
200849:
COMENDA ALI SPA



2101342 72,76X1,78
O-RING NBR /
O-RING NBR 72,76X1,78
DW135506:
DIHR-ALI SPA



2101403 34,60X2,62
O-RING NBR /
O-RING NBR 34,60X2,62
DW13004:
DIHR-ALI SPA



2101481 42,86X3,53
O-RING NBR /
O-RING NBR 42,86X3,53
DW13008:
DIHR-ALI SPA
1633:
ARISTARCO SPA



2101304 4,47X1,78 O-
RING NBR /
O-RING NBR 4,47X1,78
DW13016:
DIHR-ALI SPA
OR103:
OMNIWASH SRL -
SOCIETA' A SOCIO
UNICO
36401003:
RANCILIO SPA



2101471 28,17X3,53
O-RING NBR /
O-RING NBR
28,17X3,53
002873:
ELECTROLUX
PROFESSIONAL
S.P.A.



2101381 11,91X2,62
O-RING SNODO
VAPORE NBR /
O-RING STEAM
ARTICULATION NBR
11,91X2,62
67292:
ELECTROLUX
36404001:
RANCILIO SPA
123: ARISTARCO SPA
7130: A.T.A. SRL



2101521 110,72X3,53
O-RING NBR /
O-RING NBR
110,72X3,53
048327:
ELECTROLUX
200807:
COMENDA ALI SPA



2101391 20,29X2,62
O-RING NBR /
O-RING NBR 20,29X2,62
456010:
ELETTROBAR
DIVISIONE DELLA
EUROTEC SRL



2101513 82,14X3,53
O-RING NBR /
O-RING NBR 82,14X3,53
459008:
ELETTROBAR
DIVISIONE DELLA
EUROTEC SRL
CF64009300:



CASTEL MAC SPA

2101613 120,65X5,34
O-RING NBR /
O-RING NBR
120,65X5,34
456040:
ELETTROBAR
DIVISIONE DELLA
EUROTEC SRL
*:
EUROTEC SRL - DIV.
COOKING SERVICE
MBM



2101324 28,30X1,78
O-RING CONTATORE
VOLUMETRICO NBR /
O-RING VOLUMETRIC
METER NBR 28,30X1,78
927094:
ELETTROBAR
DIVISIONE DELLA
EUROTEC SRL



2101507 69,44X3,53
O-RING NBR /
O-RING NBR 69,44X3,53
41215:
ELETTROBAR
DIVISIONE DELLA
EUROTEC SRL



2101569 32,50X3,60
O-RING COLONNA
LAV.SCAR. 1" NBR /
"O-RING DRAIN
WASHING COLUMN 1""
NBR 32,50x3,60"
456016:
ELETTROBAR
DIVISIONE DELLA
EUROTEC SRL
904350:
SILANOS SRL
3150260:
ANGELO PO GRANDI
CUCINE SPA



2101154 GUARNIZIO
NE O-RING PER POMPA
DI LAVAGGIO /
O-RING FOR WASH
PUMP
456031*:
ELETTROBAR
DIVISIONE DELLA
EUROTEC SRL

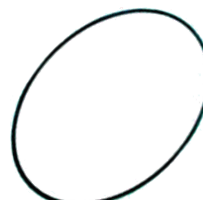

2101156 OR IN
GOMMA NBR 70SH-
94X2 /
O-RING NBR 70SH-
94X2
456022:
ELETTROBAR
DIVISIONE DELLA
EUROTEC SRL



2101165 GUANIZION
E O-RING X TUBO
MANDATA CENTRALE
X LAV. /
O-RING
CLEAN3, 35F, 25FD,
35OF, 35OFD:
ELETTROBAR



2101428 75,88X2,62
O-RING NBR /
O-RING NBR 75,88X2,62
06140004:
ELFRAMO SPA
DW10506:
DIHR-ALI SPA
REB456038:
LOTUS SPA
*: MBM
456038:
ELETTROBAR



2101380 10,78X2,62
O-RING NBR /
O-RING NBR 10,78X2,62
06140003:
ELFRAMO SPA
0083800002:
BRASILIA SPA
456006:
ELETTROBAR
DIVISIONE DELLA
EUROTEC SRL



2101512 78,97X3,53
O-RING NBR /
O-RING NBR 78,97X3,53
06140026:
ELFRAMO SPA
20205:
BREMA ICE MAKERS
SPA
2417:
LA SPAZIALE SPA



2101536 164,70X3,53
O-RING NBR /
O-RING NBR
164,70X3,53
06140010:
ELFRAMO SPA



2101494 56,75X3,53
O-RING NBR /
O-RING NBR 56,75X3,53
06140018:
ELFRAMO SPA



2101355 120,40X1,78
O-RING NBR /
O-RING NBR
120,40X1,78
06140008:
ELFRAMO SPA
REB456031:
LOTUS SPA
65456031:
RANCILIO SPA
456031: ELETTROBAR
*: MBM

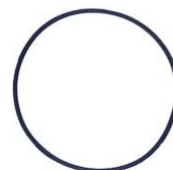

2101476 36,10X3,53
O-RING NBR /
O-RING NBR
36,10X3,53
12010165:
FAGOR
INDUSTRIALE S.R.L.



2101421 63,17X2,62
O-RING NBR /
O-RING NBR 63,17X2,62
6090146: GIORIK SPA



2101498 60,32X3,53
O-RING NBR /
O-RING NBR 60,32X3,53
6090140: GIORIK SPA



2101479 40,87X3,53
O-RING NBR /
O-RING NBR
40,87X3,53
977021000:
GRUPPO CIMBALI SPA
11315: ADLER S.P.A.
200822:
COMENDA ALI SPA
CERI46A:
OMNIWASH SRL -



2101090 GUARNIZIO
NE OR 011003 /
O-RING 011003
9011003:
GRUPPO CIMBALI SPA



2101195 GUARNIZIO
NE OR* /
O-RING
9011001:
GRUPPO CIMBALI SPA



2101196 GUARNIZIONE OR RESIST. VASCA*

O-RING X TANK HEATING ELEMENT

984285000:

GRUPPO CIMBALI SPA



2101197 GUARNIZIONE OR*

O-RING

9011200:

GRUPPO CIMBALI SPA



2101399 28,25X2,62

O-RING NBR / O-RING NBR 28,25X2,62

25239:

HOONVED - ALI SPA



2101187 GUARN. OR

2X13X17 F.SER. / O-RING 2X13X17

H200843:

HOONVED - ALI SPA

200843:

COMENDA ALI SPA



2101394 22,23X2,62

O-RING NBR / O-RING NBR 22,23X2,62

25238:

HOONVED - ALI SPA

4615: A.T.A. SRL



2101413 50,47X2,62

O-RING NBR / O-RING NBR 50,47X2,62

32310:

HOONVED - ALI SPA

929061: ELETTRORBAR



2101137 GUARNIZIONE OR 1X7X9 /

O-RING 1X7X9

34360:

HOONVED - ALI SPA

200850:

COMENDA ALI SPA



2101146 GUARNIZIONE OR 2,21X16,36X20,78 /

O-RING 2,21X16,36X20,78

H200813:

HOONVED - ALI SPA

200813:



COMENDA ALI SPA

2101410 45,70X2,62

O-RING PILETTA SCARICO NBR /

O-RING DRAIN JUNCTION NBR 45,70X2,62

28226:

HOONVED - ALI SPA

OR3181:

OMNIWASH SRL -

200867:

COMENDA ALI SPA

0835264561:

MODULAR SPA



2101317 17,16X1,78

O-RING NBR / O-RING NBR 17,16X1,78

27050:

HOONVED - ALI SPA

K01125: KASTEL SRL

200812:

COMENDA ALI SPA



2101465 20,22X3,53

O-RING NBR / O-RING NBR 20,22X3,53

30479:

HOONVED - ALI SPA

904404:

SILANOS SRL

200869:

COMENDA ALI SPA

1037: A.T.A. SRL

2934:

ARISTARCO SPA

20338: BREMA ICE

MAKERS SPA



2101424 67,95X2,62

O-RING NBR / O-RING NBR 67,95X2,62

31386:

HOONVED - ALI SPA



2101308 6,75X1,78 O-RING NBR /

O-RING NBR 6,75X1,78

31014:

HOONVED - ALI SPA

2180300: LASA SRL

1036502900:

MARENO INDUSTRIE

OR106:

OMNIWASH SRL -

2531:

ARISTARCO SPA

200818:

COMENDA ALI SPA

456030:

ELETTRORBAR

DIVISIONE DELLA

EUROTEC SRL



2101309 7,66X1,78 O-RING NBR / O-RING NBR 7,66X1,78

30475:
HOONVED - ALI SPA
281:
LA SPAZIALE SPA
36404013:
RANCILIO SPA
4648: A.T.A. SRL



2101310 8,73X1,78 O-RING NBR / O-RING NBR 8,73X1,78

25252:
HOONVED - ALI SPA
0L0555:
ELECTROLUX PROFESSIONAL S.P.A.
200809:
COMENDA ALI SPA



2101401 31,42X2,62 O-RING NBR / O-RING NBR 31,42X2,62

31639:
HOONVED - ALI SPA
2016:
UNIVER-BAR SRL
DW13000:
DIHR-ALI SPA



2101416 55,25X2,62 O-RING NBR / O-RING NBR 55,25X2,62

31948:
HOONVED - ALI SPA
20655:
BREMA ICE MAKERS SPA
2010051000:
STAFF ICE SYSTEM SRL



2101392 20,64X2,62 O-RING NBR / O-RING NBR 20,64X2,62

34332:
HOONVED - ALI SPA
225:
LA SPAZIALE SPA
1295300002:
BRASILIA SPA
190054:
MAGISTER SISTEMA CAFFE' SRL
OR128:
OMNIWASH SRL
25: ARISTARCO SPA
200821:
COMENDA ALI SPA



2101426 71,12X2,62 O-RING NBR / O-RING NBR 71,12X2,62
25245:

HOONVED - ALI SPA
200868:
COMENDA ALI SPA



2101717 98,02X3,53 O-RING NBR / O-RING NBR 98,02X3,53

H200803:
HOONVED - ALI SPA
200803:
COMENDA ALI SPA



2101313 11,11X1,78 O-RING NBR / O-RING NBR 11,11X1,78

30473:
HOONVED - ALI SPA
CGR114:
ELETTOBAR DIVISIONE DELLA EUROTEC SRL



2101325 29,87X1,78 O-RING NBR / O-RING NBR 29,87X1,78

25244:
HOONVED - ALI SPA



2101302 2,90X1,78 O-RING NBR / O-RING NBR 2,90X1,78

25251:
HOONVED - ALI SPA



2101322 25,12X1,78 O-RING NBR / O-RING NBR 25,12X1,78

H200817:
HOONVED - ALI SPA
200817:
COMENDA ALI SPA



2101346 88,64X1,78 O-RING NBR / O-RING NBR 88,64X1,78

34340:
HOONVED - ALI SPA
DW18245:
DIHR-ALI SPA



2101348 95,00X1,78
O-RING NBR /
O-RING NBR 95,00X1,78
35497
: HOONVED - ALI SPA
630424:
COMENDA ALI SPA

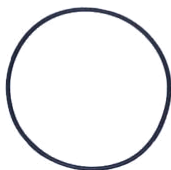

2101376 7,60X2,62 O-
RING NBR /
O-RING NBR 7,60x2,62
LAR70010050:
LAINOX ALI SPA



2101478 39,70X3,53
O-RING NBR /
O-RING NBR 39,70X3,53
0200056:
LAMBER DI AFFABA
FRANCESCO & C.
4329:
UNIVER-BAR SRL
4616: A.T.A. SRL



2101305 5,28X1,78 O-
RING NBR /
O-RING NBR 5,28X1,78
0200303:
LAMBER DI AFFABA
FRANCESCO & C.
1539:
UNIVER-BAR SRL
DW13001:
DIHR-ALI SPA
OR2021:
OMNIWASH SRL -
SOCIETA' A SOCIO
UNICO
456009:
ELETTROBAR
36404014:
RANCILIO SPA



2101314 12,42X1,78
O-RING SILANOS NBR /
O-RING SILANOS NBR
12,42X1,78
2188520: LASA SRL
0200103:
LAMBER DI AFFABA
FRANCESCO & C.
H200824:
HOONVED - ALI SPA
DW13009:
DIHR-ALI SPA
OH0800:ELECTROLUX
OR2050:
OMNIWASH SRL
1036502600:
MARENO INDUSTRIE
904320:
SILANOS SRL
200824:
COMENDA ALI SPA



2101400 29,83X2,62
O-RING NBR /
O-RING NBR 29,83X2,62
218570: LASA SRL
OR3118:
OMNIWASH SRL -
SOCIETA' A SOCIO
UNICO
2010051500:
STAFF ICE SYSTEM
SRL



2101315 14,00X1,78
O-RING NBR /
O-RING NBR 14,00X1,78
218255: LASA SRL
25243:
HOONVED - ALI SPA
7601: A.T.A. SRL



2101408 42,52X2,62
O-RING NBR /
O-RING NBR 42,52X2,62
218750: LASA SRL
OR3168:
OMNIWASH SRL -
SOCIETA' A SOCIO
UNICO



2101306 6,07X1,78 O-
RING
ELETTROVALVOLA
NBR /
O-RING SOLENOID
VALVE NBR 6,07X1,78
00625:
LA SPAZIALE SPA
067898:
ELECTROLUX
PROFESSIONAL
S.P.A.
190014:
MAGISTER SISTEMA
CAFFE' SRL
36402001:
RANCILIO SPA
0083300002:
BRASILIA SPA
456060:
ELETTROBAR
DIVISIONE DELLA
EUROTEC SRL
4692: A.T.A. SRL



2101455 12,10X2,70
O-RING NBR /
O-RING NBR 12,10X2,70
07580:
LA SPAZIALE SPA
190010:
MAGISTER SISTEMA
CAFFE' SRL



2101510 74,60X3,53
O-RING NBR /
O-RING NBR 74,60X3,53
536026700:
LOTUS SPA



2101495 57,15X3,53
O-RING NBR /



O-RING NBR 57,15X3,53
190052:
MAGISTER SISTEMA
CAFFE' SRL

2101496 58,74X3,53
O-RING NBR /
O-RING NBR 58,74X3,53
190051:
MAGISTER SISTEMA
CAFFE' SRL



2101489 50,80X3,53
O-RING NBR
SCAMBIATORE
CIMBALI /
O-RING NBR 50,80X3,53
CM099200:
MARENO INDUSTRIE
ALI SPA
927097:
ELETTROBAR
DIVISIONE DELLA
EUROTEC SRL



2101585 53,34X5,34
O-RING NBR /
O-RING NBR 53,34X5,34
2604100:
MARENO
INDUSTRIE ALI SPA



2101378 9,19X2,62 O-
RING NBR3037 /
O-RING NBR 9,19x2,62
MA2867700:
MARENO INDUSTRIE
ALI SPA
456011:
ELETTROBAR
DIVISIONE DELLA
EUROTEC SRL



2101523 117,07X3,53
O-RING NBR /
O-RING NBR
117,07X3,53
S000ANA03:
MAZZER LUIGI SRL



2101518 101,2X3,53
O-RING NBR /
O-RING NBR 101,2X3,53
0835351011:
MODULAR SPA
456001:
ELETTROBAR
DIVISIONE DELLA
EUROTEC SRL
CF64009303:
CASTEL MAC SPA



2101402 33,00X2,62
O-RING TROPPOPIENO
NBR /
O-RING OVERFLOW
NBR 33,00X2,62
18010033:
NUOVA SIMONELLI
SPA
OR3131: OMNIWASH



2101590 69,22X5,34
O-RING NBR /
O-RING NBR 69,22X5,34
OR6275: OMNIWASH
2374:
ARISTARCO SPA



2101411 47,30X2,62
O-RING NBR /
O-RING NBR 47,30X2,62
OR3187:
OMNIWASH SRL -
SOCIETA' A SOCIO
UNICO



2101017 OR
RESISTENZA BOILER
62P /
BOILER HEATING
ELEMENT O RING 62P
ORRB3F:
OMNIWASH SRL -
SOCIETA' A SOCIO
UNICO

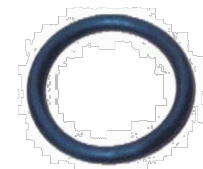

2101383 13,10X2,62
O-RING NBR /
O-RING NBR 13,10X2,62
OR117:
OMNIWASH SRL -
200806:
COMENDA ALI SPA



2101311 9,25X1,78 O-
RING GRUPPO NBR /
O-RING GROUP NBR
9,25X1,78
36402003:
RANCILIO SPA
456019: ELETTROBAR
*: MBM



2101316 15,60X1,78
O-RING NBR /
O-RING NBR 15,60X1,78
36401008:
RANCILIO SPA



2101382 12,37X2,62
O-RING NBR /
O-RING NBR 12,37X2,62
36405002:
RANCILIO SPA



2101004 GUARNIZIO
NE LIVELLO RANCILIO
/
LEVEL EXAGONAL OR
RANCILIO
36103002:
RANCILIO SPA

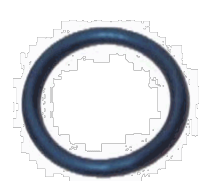

2101793 O RING /
O RING
64004110:
SCOTSMAN DIV.
FRIMONT SPA



2101467 23,40X3,53
O-RING NBR /
O-RING NBR 23,40X3,53
64013400:
SCOTSMAN DIV.
FRIMONT SPA
PR75505: FABBA SRL



2101487 49,20X3,53
O-RING NBR /
O-RING NBR 49,20X3,53
64004118:
SCOTSMAN
*:MBM
456061:
ELETTROBAR



2101388 17,13X2,62
O-RING NBR /
O-RING NBR 17,13X2,62
64008100:
SCOTSMAN
33798:
HOONVED - ALI SPA
9010005:
GRUPPO CIMBALI
DW13007:
DIHR-ALI SPA
OR122:
OMNIWASH SRL -
200819:
COMENDA ALI SPA



2101795 O RING /
O RING
64004113:
SCOTSMAN DIV.
FRIMONT SPA



2101138 O-RING
F100/120/200 /
O-RING F100/120/200
64008400:
SCOTSMAN DIV.
FRIMONT SPA
CF64008400:
CASTEL MAC SPA

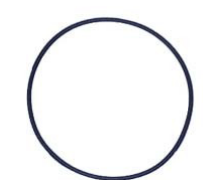

2101488 50,40X3,53
O-RING NBR /
O-RING NBR 50,40X3,53
0108055:
SILKO ALI SPA
808054:
EMMEPI GRANDI
CUCINE S.R.L.
862051:
OFFCAR THE GREAT
COOKING S.R.L.
6090144: GIORIK SPA



2101492 53,97X3,53
O-RING NBR /
O-RING NBR 53,97X3,53
904395:
SILANOS SRL
200842:
COMENDA ALI SPA



2101833 O-RING
VMQ70 GIALLO FDA
17.16X1.78 /
O-RING YELLOW
VMQ70 FDA 17.16X1.78
*: SPINEL SRL



2101834 O-RING
VMQ70 GIALLO FDA
9.25X1.78 /
O-RING YELLOW
VMQ70 FDA 9.25x1.78
*: SPINEL SRL



2101835 O-RING
VMQ70 FDA 40.65X5.34
GIALLO /
O-RING YELLOW
VMQ70 FDA 40.65X5.34
*: SPINEL SRL



2101785 OR NERO
8X2 MM ALBERO
CENT.(SIS.
MAGNETICO) /
O-RING 8X2 MM
1002803217:
UGOLINI SPA



2101418 58,42X2,62
O-RING NBR /
O-RING NBR 58,42X2,62
1002802804:
UGOLINI SPA
047462:
ELECTROLUX
200852:
COMENDA ALI SPA



2101379 9,92X2,62 O-
RING RESISTENZA
VASCA LT110 NBR
/ O-RING TANK
ELEMENT LT110 NBR
9,92X2,62
1568:

UNIVER-BAR SRL
DW13003: DIHR-ALI
SPA
36404016: RANCILIO
SPA
904391:
SILANOS SRL
200810:
COMENDA ALI SPA
*: MBM
456015:
ELETTROBAR
OR112:
OMNIWASH SRL -
SOCIETA' A SOCIO
UNICO



2101231 OR RING
D.28X2,5 /
OR RING D.28X2,5
2707049:
WINTERHALTER
ITALIA SRL



2101053 OR PER
RACCORDI MINISIT /
O-RING X MINISIT



2101214 GUARNIZIO
NE /
GASKET
046595:
ELECTROLUX
PROFESSIONAL
S.P.A.



2101034 GUARNIZIO
NE R.E. ZANUSSI
048483 /
HEATING ELEMENT
GASKET ZANUSSI
048483
048483:
ELECTROLUX
PROFESSIONAL
S.P.A.



2101733 GUARNIZIO
NE RESISTENZA
VASCA ELETTROBAR /
GASKET FOR TANK
HEATING ELEMENT
ELETTROBAR
*:
EUROTEC SRL - DIV.
COOKING SERVICE
MBM
437086:
ELETTROBAR
DIVISIONE DELLA
EUROTEC SRL



2101030 GUARNIZIO
NE RESISTENZA
ELFRAMO /
HEATING ELEMENT
GASKET ELFRAMO
00003430:
ELFRAMO SPA

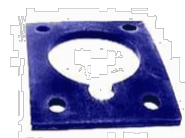

2101216 GUARNIZIO
NE MANDATA
LAVAGGIO
SUPERIORE / GASKET
*:
EUROTEC SRL - DIV.
COOKING SERVICE
MBM
80178:
ELETTROBAR
DIVISIONE DELLA
EUROTEC SRL



2101803 Z400703000
JUNTA ESTANQUE.
1003113 /
GASKET Z400703000
1003113
12023533:
FAGOR
INDUSTRIALE S.R.L.



2101837 GUARNIZIO
NE PER TROPPOPIENO
NBR75 /
OR FOR OVERFLOW
104465:
KRUPPS S.R.L.



2101763 GASKET /
GASKET
1300070400:
SCOTSMAN DIV.
FRIMONT SPA



2101183 GUARNIZIO
NE RACCORDO
DOSATORE 1/8" /
"O-RING 1/8""
903400:
SILANOS SRL



2101726 GUARN.
85X85 COL. LAV. /
GASKET 85X85
903381:
SILANOS SRL

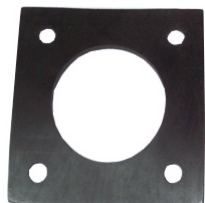

2101791 GUARNIZIO
NE /
GASKET
82000014:
WINTERHALTER
ITALIA SRL



2101731 GUARNIZIO
NE PER FILTRO POMPA
/
PUMP FILTER GASKET
13080:
BREMA ICE MAKERS
SPA



2101173 GUARNIZIO
NE OR X TROPPO
PIENO /
SEAL OR X OVERFLOW
20233:
BREMA ICE MAKERS
SPA



2101221 GUARNIZIO
NE SUPPORTO GETTI /
JET SUPPORT O-RING
2703020: LASA SRL



2101089 GUARNIZIO
NE OR /
O-RING
64004120:
SCOTSMAN DIV.
FRIMONT SPA



2101865 GASKET /
GASKET
64014000:
SCOTSMAN DIV.
FRIMONT SPA



2101794 O RING /
O RING
64010100:
SCOTSMAN DIV.
FRIMONT SPA

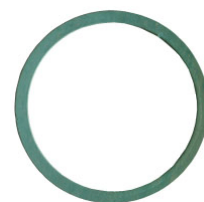

2101839 RING
GASKET W/SPRING /
RING GASKET
W/SPRING
64009706:
SCOTSMAN DIV.
FRIMONT SPA



2101762 GUARNIZIO
NE SILICONE PER
PISTONE RUBINETTO
OR123 /
O-RING
2280015100:
UGOLINI SPA



2101007 GUARN.
RESISTENZA VASCA
IME /
TANK HEATING
ELEMENT O RING IME
6181226T:
OMNIWASH SRL -
SOCIETA' A SOCIO
UNICO

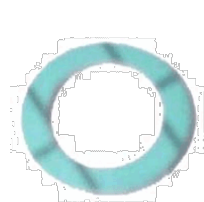

2101008 OR
RESISTENZA BOILER
IME /
BOILER HEATING
ELEMENT O RING IME
6423035:
OMNIWASH SRL -
SOCIETA' A SOCIO
UNICO



2101858 GUARNIZIO
NE OR 4325 /
SEAL OR 4325
N20987:
BREMA ICE MAKERS
SPA



2101210 GUARNIZIONE OR PER TROPPO PIENO / O-RING
20688:
BREMA ICE MAKERS SPA



2101475 34,52X3,53
O-RING NBR / O-RING NBR 34,52X3,53
027301:
ELECTROLUX PROFESSIONAL S.P.A.
20689:
BREMA ICE MAKERS SPA
200814:
COMENDA ALI SPA
CF64009302:
CASTEL MAC SPA



2101097 OR RUBINETTO / OR COCK GBG
SL300000118:
GBG ALI SPA



2101025 OR 177 MISS / O RING 177 MISS
36405001:
RANCILIO SPA



2101807 GUARN.OR FANGIA CALDAIA / O-RING
36404114:
RANCILIO SPA

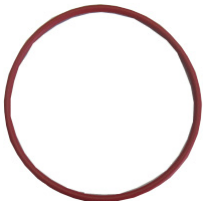

2101764 GUARNIZIONE 42,86X3,53 SILICONE / O-RING 42,86X3,53 SILICONE



2101817 GUARNIZIONE OR TAMPONE AMB RL 6,5 / O-RING AMB RL 6,5



2101851 R10 ANELLO OR 12,10X2,70 SILICONE ROSSO / R10 O-RING 12,10 X2,70 RED SILICONE



1107012 MAGNETE PROTETTO 62X18X10 M340 / PROTECTED MAGNET 62X18X10 M340
13642: A.T.A. SRL



1107076 MAGNETE PERMANENTE 24X12 SE/1 / MAGNETIC MICRO-SWITCH 24X12 SE/1
411002:
COMENDA ALI SPA

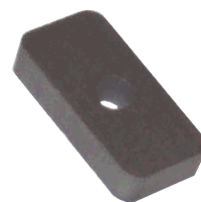

1107188 MAGNETE PERMANENTE 35X11X6 / PERMANENT MAGNET 35X11X6
411004:
COMENDA ALI SPA

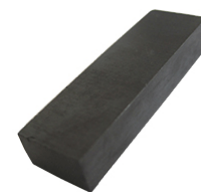

1107191 MAGNET / MAGNET
1100056302:
SCOTSMAN ICE SRL
*: CASTEL MAC SPA



1107149 MAGNETE / MAGNET
CM19355004/0:
CASTEL MAC SPA
CM19355004:
SCOTSMAN ICE SRL



1107167 MAGNETE PER MICROINTERRUTTOR E CAPP A / MICRO-SWITCH MAGNET
927088:
ELETTOBAR DIVISIONE DELLA EUROTEC SRL



1107130 MAGNETE

8X16X40 +
CUST.XDEM201 /
MAGNET 8X16X40 +
COVER.XDEM201

926014:

ELETTROBAR

*:

MBM- EUROTEC SRL
- DIV. COOKING
SERVICE



1107141 MAGNETE

STEM M303 N CDC GE
32 /
MAGNET STEM M303
N CDC GE 32

0800142:

LAMBER DI AFFABA
FRANCESCO & C.

CM19355007:

SIMAG SPA

CM19355007:

SCOTSMAN ICE SRL

CM19355007/0:

CASTEL MAC SPA



=1107142

1107213 MAGNET / MAGNET

1100056305:

SCOTSMAN ICE SRL



1107079 MAGNETE

SAP-P100 /
MAGNET

9131447*:

GRUPPO CIMBALI
SPA

986034000:

GRUPPO CIMBALI
SPA



1107004 MAGNETE

X REED SILANOS /
REED MAGNET
SILANOS

986034000:

GRUPPO CIMBALI
SPA

H32969:

COMENDA ALI SPA

411010:

COMENDA ALI SPA

903651: SILANOS
SRL

049627:

ELECTROLUX

32969:

HOONVED - ALI SPA

9131447:

GRUPPO CIMBALI
SPA



1107127 MAGNETE

IN NEODIMIO
40X14X3,8mm /
MAGNET
40X14X3,8mm

KRUPPS S.R.L.



1107170 MAGNETE

PORTA
MICROINTERRUTTOR
E - MICROSWITCH /
MICROSWITCH
MAGNET

1225: KRUPPS S.R.L.



1107229 MAGNETE

PER SENSORE IN
NEODIMIO /
MAGNET FOR SENSOR
NEODYMIUM

3205:

ARISTARCO KASTEL
SPA



1107089 MICROINTE

RRUTTORE
(NORMALMENTE
APERTO) /
MICRO-SWITCH OPEN

23372:

BREMA ICE MAKERS
SPA

68023372:

RANCILIO SPA

9544800: MEIKO



1107088 MICROINTE

RRUTTORE
(NORMALMENTE
CHIUSO) /
MICRO-SWITCH

68023196:

RANCILIO SPA

085298:

ELECTROLUX
PROFESSIONAL
S.P.A.

23196:

BREMA ICE MAKERS
SPA



1107186 MICROGAL

LEGIANTE C/LEVA
74X7 VR-NA 15GR
2CONT. /
MICRO-SWITCH
FLOATER WITH
LEVER 74X7 VR-NA
15GR 2CONT.

926054:

BRICE ITALIA SRL



1107122 MICROSWI
TCH X COD.2131 3/4 /
MICROSWITCH X
COD.2131 3/4
L2136: **LUXIA SRL**



1107058 MICRO
INVERSORE 3 POLI /
MICRO-REVERSER 3
POLES



1107031 MICROINTE
RRUTTORE GH2 3
CONTATTI /
MICRO-SWITCH GH2
3CONCATS
23055:
**BREMA ICE MAKERS
SPA**



1107203 Microinterrutt
ore /
MICRO SWITCH
23930:
**BREMA ICE MAKERS
SPA**



1107133 MICRO A
LEVA LUNGA /
MICRO SWITCH LONG
LEVER
CM19410207/0:
CASTEL MAC SPA

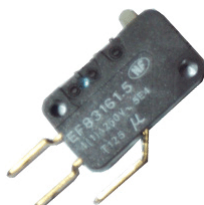

1107208 MICRO
FAEMA 3000
MONOFASE /
FAEMA PHASE MICRO
3000
3342133738: **FAEMA**



1107037 MICRO
ARRESTO MD/AT /
STOP MICRO-SWITCH
MD/AT
34100003:
RANCILIO SPA



1107137 LEVA
LUNGA CON ROTELLA
X(058) /
LEVER WITH ROLL
FOR MICROSWITCH
1107058



1107042 MICROINTE
RRUTTORE AH715378 /
MICRO SWITCH
AH715378

32W4240:
**ANGELO PO GRANDI
CUCINE SPA**
50123*: **CEADO SRL**
DW10704:
DIHR-ALI SPA
10704: **DIHR-ALI SPA**



1107082 MICRO
DEVIATORE 16A
C/LEVA /
MICRO-SWITCH 16A
PASSPORT1040,
GL1040, GL1240:
ARISTARCO KASTEL
C00061023:
MACAP SRL

808053: **EMMEPI**
862311: **OFFCAR**
1037111300:
SILKO ALI SPA
25190007:
ELFRAMO SPA
6043085: **GIORIK
SPA**
30610:
SISTEMA PROJECT
MA1037111300:
SILKO ALI SPA
MA1037111300:
**MARENO
INDUSTRIE**
01035: **FABAR SRL**

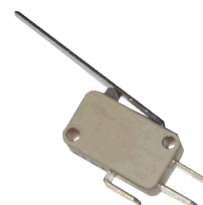

1107052 MICRODEV.
S 16 CON LEVA 16829C
/
MICRO-SWITCH S 16
WITH LEVER 16829C
120323:
COMENDA ALI SPA

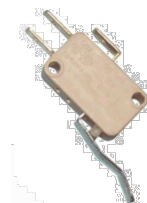

1107221 MICROINTE
RRUTTORE
DEVIATORE N16 /
MICRO SWITCH
DEVIATOR N16
25190003:
ELFRAMO SPA



1107150 MICROINTE
RRUTTORE CON
MAGNETE /
MICROSWITCH WITH
MAGNET
103540K:
KRUPPS S.R.L.
103540EX:
KRUPPS S.R.L.

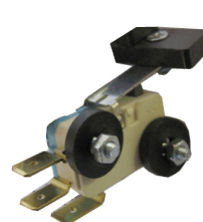

1107117 MICROPOR
TA MOD.E34/86HNG /
DOOR
MICROSWITCHO.E34/8
6HNG
3121030: **LASA SRL**



1107193 MICRO
INFERIORE
COMPLETO /
LOWER COMPLETE
MICROSWITCH
S005MIA04AQQQex
: **MAZZER LUIGI SPA**
S005MIA11QQQ:
MAZZER LUIGI SPA



1107172 MICROINT.
EF46FE1515
NAAH71535 /
MICRO-SWITCH
EF46FE1515
NAAH71535
RTBF900277:
MBM- EUROTEC SRL
- DIV. COOKING
SERVICE



1107226 MICRO
PORTA
LAVATOVIGLIE /
MICRO SWITCH DOOR
DISHWASHER
41207500:
MODULAR SPA



1107199 MICROIN
POST 3 CONTATTI
MOD.6 (NT 2 /
MICROSWITCH WITH
LEVER 3
CONNECTIONS MOD. 6
(NT 2
CEMP62PS306:
OMNIWASH SRL



1107166 MICROINTE
RRUTTORE PORTA /
DOOR MICROSWITCH
4095:
UNIVER-BAR SRL



1107119 MICROINTE
RRUT. DEVIATORE
DOPPIO N16 /
DOUBLE
MICROSWITCH N16
25190005:
ELFRAMO SPA



1107227 Microinterrutt
ore con staffa Compact /
Microswitch bracket
Compact
4780:
UNIVER-BAR SRL



1107234 MICROINTE
RRUTTORE DOPPIO
CON STAFFA /
DOUBLE
MICROSWITH
COMPLETE WITH
BRACKET
4762:
UNIVER-BAR SRL



1107187 ASS. MICRO
SINGOLO AL 50.34/40 /
MICROSWITCH
ASSEMBLY AL
50.34/40
9445:
**ARISTARCO KASTEL
SPA**



1107027 MICRO
PORTA COMPL. X CS
IME /
COMPLETE DOOR
MICRO-SWITCH CS
IME
CEMP12CSC:
OMNIWASH SRL

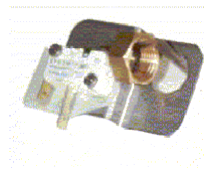

1107123 "MICROIN.
PORTA CL NT+LEVA
COMP LEVA A
"ELLE" /
DOOR MICROSWITCH
CEMP12CL*:
**OMNIWASH SRL -
SOCIETA' A SOCIO
UNICO**
CEMP12CLC:
**OMNIWASH SRL -
SOCIETA' A SOCIO
UNICO**

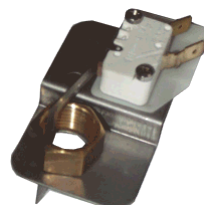

1107126 MICRO 16A
NO STRUTTURA
METALLICA 23700 /
MICRO-SWITCH 16A
23700
23700:
**BREMA ICE MAKERS
SPA**



1107077 MICROINTE
RRUTTORE CON
TASTO ROSSO /
MICRO-SWITCH WITH
RED PUSH-BUTTON
GIRARROSTI: **CB SRL**
0101184:
SILKO ALI SPA



1107026 MICROINTE
RRUTTORE DI
SICUREZZA /
SAFETY MICRO-
SWITCH
PR70011: **FABA SRL**



1107078 ASSIEME
MICRO PORTA P80 /
MICRO-DOOR P80
984759000:
**GRUPPO CIMBALI
SPA**
9131735:
**GRUPPO CIMBALI
SPA**

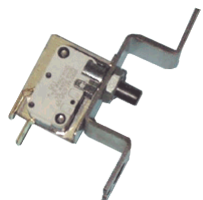

1107128 MICROINTE
RRUTTORE DI
SICUREZZA 3
CONTATTI 16A /
SAFETY MICRO-
SWITCH 3 CONTACTS
4818135868: **FAEMA**
120313:
COMENDA ALI SPA
532020310: **FAEMA**
532020300: **FAEMA**
1519: **FOINOX S.P.A.**
539502: **GICO SPA**
LAR65260530:
LAINOX ALI SPA
50304530:
LAINOX ALI SPA



1107178 MICRO
MOD. N16 CON
PULSANTE /
MICROSWITCH N16
WITH PUSH BUTTON
120304:
COMENDA ALI SPA



1107035 ASS. MICRO
TELE. DOPPIO
SICUREZZA PORTA /
MICRO SWITCH WITH
PRESSURE PIN
2651:
**ARISTARCO KASTEL
SPA**
PASSPORT45.30/50.3
2/50.35/55.40,MAST
ER22,PROJET28E/EM
,ALISEO:
**ARISTARCO KASTEL
SPA**



1107215 MICRO
COMPLETO AE35 /
MICRO COMPLETE
AE35
3528ex:
**ARISTARCO KASTEL
SPA**
12271:

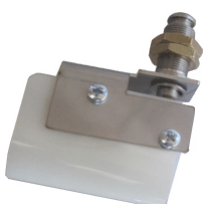

**ARISTARCO KASTEL
SPA**

1107016 MICRO
INTERRUTTORE
Z15GO OMRON /
MICRO-SWITCH
Z15GO OMRON
65260540:

LAINOX ALI SPA
LAR65260540:
LAINOX ALI SPA
LAR65260540:
**OLIS DIVISIONE DI
ALI GROUP SPA -**



1107060 MICRODEVI
ATORE A.PO /
MICRO-SWITCH A.PO
32W0960:
**ANGELO PO GRANDI
CUCINE SPA**



1107176 FINECORSA
A PULSANTE MF17 /
LIMIT SWITCH MF17
532097000: **FAEMA**
DW70305:
DIHR-ALI SPA



1107189 MICROINTE
R.PULS.FILETT+ROT.B
M2 /
MICROSWITCH WITH
BUTTON
EG03200:
OEM ALI SPA



1107190 MICRO
PULS.FIL.C/ROT.TRAS
V.BM2 /
MICROSWITCH WITH
BUTTON
EG03700:
OEM ALI SPA



1107075 MICRO
INTERRUTTORE X
TUTTE LEVETTA-
ANTICA /
MICRO-SWITCH
SVTMM008:
S.V. ITALIA SRL



1107091 MICRODEVI
ATORE 15A PRESS. A
LEVA /
MICRO-SWITCH 15A

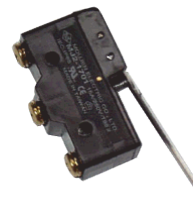

1107054 MICRO
PORTA+MAGNETE BR-
BC-FC /
MICRO-
DOOR+MAGNET BR-
BC-FC
120346:
COMENDA ALI SPA



1107092 MICRODEVI
ATORE LEVA PIANA
CONT. /
MICRO-SWITCH

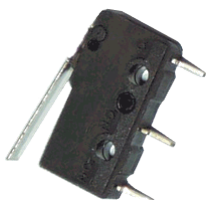

1107093 ATTUATOR
E LEVA SAGOMATA /
MICRO-SWITCH

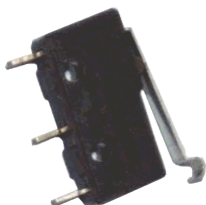

1107094 MICRODEVI
ATORE A PULSANTE
CONTINUO /
MICRO-SWITCH WITH
PUSH-BUTTON



1107095 ATTUATOR
E A LEVA CON
ROTELLA CONT. /
MICRO-SWITCH WITH
SMALL WHEEL

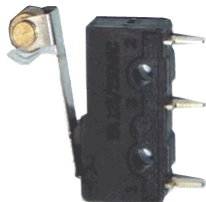

1107096 MICRODEVI
ATORE LEVA PIANA
3A 250V TERM. CORSA
/
MICRO-SWITCH 3A
250V



1107097 MICRODEVI
ATORE LEVA SAGOM.
CTERM. PER C.S3A UL
/
MICRO-SWITCH 3A
UL

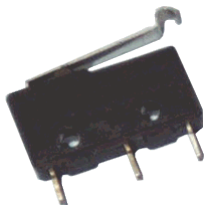

1107098 MICRODEVI
ATORE A PULSANTE
TERM PER C.S. 3 A UL /
MICRO-SWITCH 3A
UL



1107099 MICRODEVI
ATORE C/ROTELLA
TERM 3A /
MICRO-SWITCH WITH
SMALL WHEEL 3A



1107100 ATTUATOR
E A LEVA FASTON 4,8
LEVA 52MM /
MICRO-SWITCH
FASTON 4,8 52mm



1107101 MICROINTE
RRUTTORE A LEVA
C.ROTELLA FASTON
4,8 /
MICRO-SWITCH WITH
SMALL WHEEL
FASTON 4,8



1107235 #MICRO
FINECORSA DI
CHIUSURA /
LIMIT MICROSWITCH
DW10600138:
DIHR-ALI SPA



1107105 FINECORSA
PIST.C.ROTELLA
UNIDIREZ. /
MICRO-SWITCH WITH
SMALL WHEEL



1107120 MICROINTE
RRUTTORE /
MICROSWITCH
23746:
BREMA ICE MAKERS
SPA



1107043 FINECORSA
FD 102 COMENDA /
MICRO-SWITCH FD
102 COMENDA
120326:
COMENDA ALI SPA



1107069 MICRO CON
LEVA LC/
MICROSWITCH LC
120364:
COMENDA ALI SPA



1107073 MICRO
FINECORS A LEVA
GIREVOLE FD552-S2 /
MICRO-SWITCH
FD552-S2

120320:

COMENDA ALI SPA

H120320:

HOONVED - ALI SPA



1107179 MICROINTE
RRUTTORE DI FINE
CORS A /
LIMIT MICROSWITCH
927304:

ELETTROBAR

DIVISIONE DELLA
EUROTEC SRL

*:

MBM- EUROTEC SRL

- DIV. COOKING

SERVICE



4120073 LEVA
MICRO MOD. FD 503 /
POSITION SWITCH
MOD. FD 503

H870129EX:

HOONVED - ALI SPA

33435:

HOONVED - ALI SPA



1107109 FINECORS A
STELO A MOLLA /
LIMIT MICROSWITCH
MICRO-SWITCH



1107111 FINECORS A
ASTA IN POLIAMMIDE
/
MICRO-SWITCH



1107013 MICROINTE
RRUTTORE
MAGNETICO /
MAGNETIC MICRO-
SWITCH

13105: A.T.A. SRL



1107068 SENSORE
MAGNETICO /
MAGNETIC MICRO-
SWITCH

120356: COMENDA

ALI

120366: HOONVED

33188: HOONVED



1107045 REED
SENZA TRIAC /
REED WITHOUT
TRIAC

120348:

COMENDA ALI SPA

120348:

HOONVED - ALI SPA



1107048 REED
MICRO PORTA E530 /
REED MICRO DOOR
E530

DW3003112:

DIHR-ALI SPA

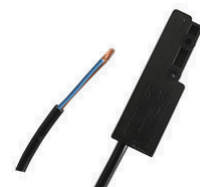

1107046 MICROCON
TATTO MAGNETICO
REED /
MICROSWITCH
MAGNETIC REED

DW10778:

DIHR-ALI SPA

695001: GICO SPA



1107238 INTERRUTT
ORE MAGNETICO CPL
/
MAGNETIC SWITCH

Completo

088578:

ELECTROLUX

PROFESSIONAL

S.P.A.



1107223 MICROINTE
RRUTTORE + ASTINA
E CAVO /
MICRO SWITCH +
ROD AND CABLE

059565:

ELECTROLUX

PROFESSIONAL

S.P.A.

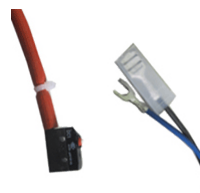

1107132 MAGNETE
M302AFO /
MAGNET M302AFO
217003:

ELETTROBAR

DIVISIONE DELLA

EUROTEC SRL



1107074 SENSORE
MAGNETICO /
TEMPERATURE
PROBE

9131616:

GRUPPO CIMBALI

SPA

984159000:

GRUPPO CIMBALI

SPA



1107240 REED
SWITCH /
REED SWITCH
00785470001:
HOBERT GmbH



L=315mm

1107171 MICRO
PORTA COMPLETO /
DOOR MAGNETIC
SWITCH
R65265100:
LAINOX ALI SPA
LAR65265100:
LAINOX ALI SPA



1107020 MICROMAG
NETICO E510 1V
DA+M360 /
MAGNETIC MICRO-
SWITCH E510 1V
DA+M360
995405: LAINOX ALI
MA5169100: MARENO
25110113: ELFRAMO
211002ex:
ELETTROBAR
80871: ELETTROBAR
FR995405: LAINOX
FR995405: SILKO
ALI



1105366 CURTAIN
SWITCH /
CURTAIN SWITCH
1100056306:
SCOTSMAN ICE SRL
1100056301EX:
SCOTSMAN ICE SRL



1107216 REED
MAGNETICO
LAVASTOVIGLIE /
REED MAGNETIC
DISHWASHER
909290:
SILANOS SRL



1107194 MICRO
MAGNETICO /
MICRO MAGNETICO



1107154 SENSORE
MAGNET.
RETTANGOL. /
MAGNETIC MICRO-
SWITCH
LS7:
ELECTROLUX
PROFESSIONAL
S.P.A.



1107163 SENSORE
MAGNETICO /
MAGNETIC SWITCH
048486:
ELECTROLUX
PROFESSIONAL
S.P.A.



1107204 CONT.MAG
NETICO+CAVO
29N.O.cm25 /
MAGNETIC CONTACT
+ CABLE 29N.O.cm25
211001:
ELETTROBAR
DIVISIONE DELLA
EUROTEC SRL



1107139 MICROINTE
RRUTTORE
MAGNETICO PER
LAVASTOVIGLIE /
MAGNETIC
MICROSWITCH FOR
DISHWASHERS
DEM2038: COLGED
D926195:
GIGA GRANDI
CUCINE SRL
926195:
ELETTROBAR



1107211 MICRO
MAGNETICO Ø 8 mm. /
MICRO MAGNETIC Ø
8 mm.



1107003 REED
MAGNETICO SILANOS
/
MAGNETIC REED
SILANOS
32W3240:
FIMAR S.P.A.
TR0309:
SILANOS SRL



1107061 INTERRUPT
ORE DI LIVELLO
SUPERIORE /
FLOAT SWITCH
5692: A.T.A. SRL



1107050 REED
GALLEGGIANTE XB.T.
/
MICRO-SWITCH
FLOATER REED X B.T.
120358:
COMENDA ALI SPA



1107047 REED
ECONOMIZZATORE /
ECONOMIZER REED
DW2000309:
DIHR-ALI SPA

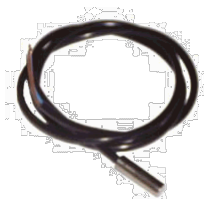

1107065 REED
MAGNETICO N1000-
N1300 /
MAGNETIC REED
N1000-N1300
TR0666:
SILANOS SRL



1107195 INTERRUTT
ORE GALLEGGIANTE /
FLOAT SWITCH
5528255:
WINTERHALTER
ITALIA SRL



1107201 BLOCCO
PORTA INTERRUTTORE
125AK274 /
PLATE 125AK274
0301082:
LAMBER DI AFFABA
FRANCESCO & C.

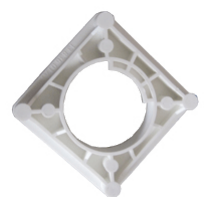

1107192 CHIUSURA
MAGNETICA CPL
PIASTRINA /
MAGNETIC LOCK
COMPLETE
37180010:
ELFRAMO SPA







1107200 AZIONATO
RE MICRO POSTER.
62P/S PPL /
PRESSURE PLATE FOR
MICROSWITCH 62PS
PPL
CEAZM62PS:
OMNIWASH SRL





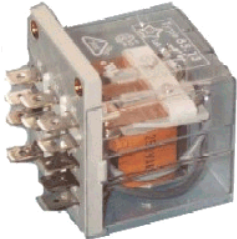
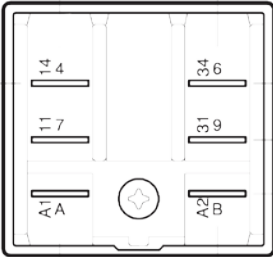
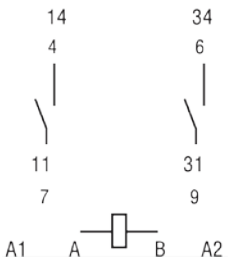
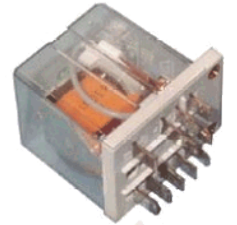
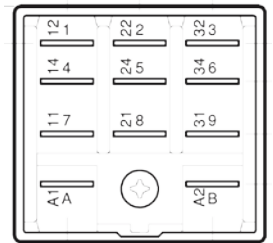
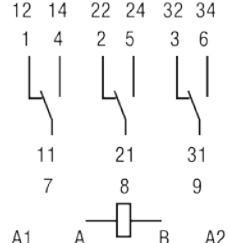
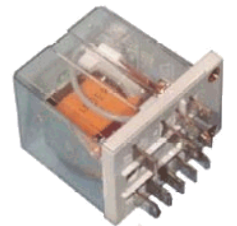
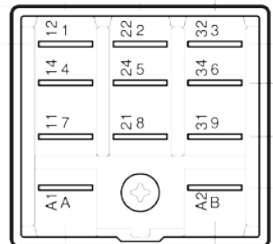
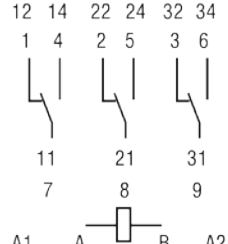
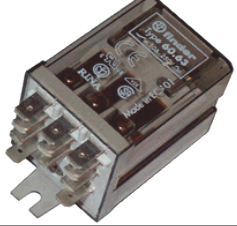
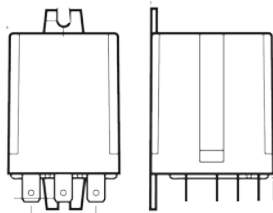
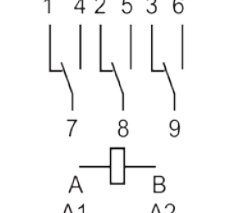

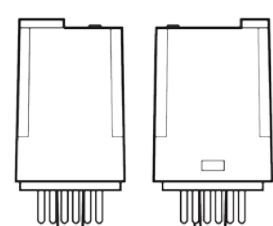
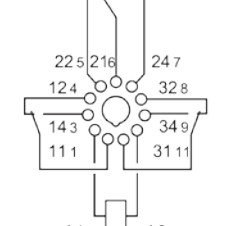
1107214 CURTAIN
SWITCH /
CURTAIN SWITCH
1100056304:
SCOTSMAN ICE SRL

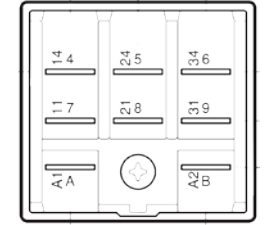
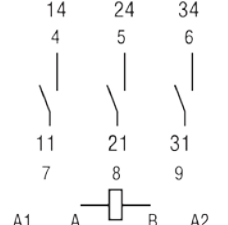

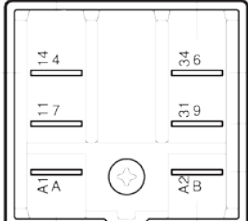
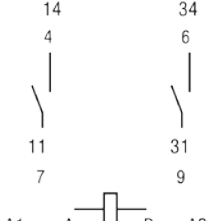
RELE'/RELAYS

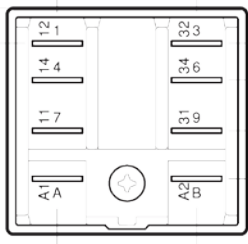
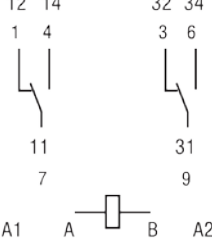
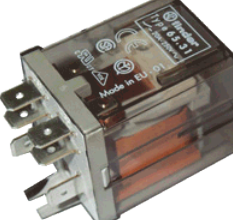
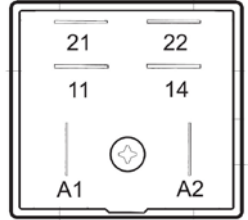
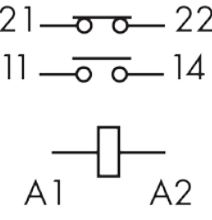
CODICE S&P S&P CODE		CONTATTI CONTACTS	SCHEMA ELETTRICO WIRING DIAGRAM	DESCRIZIONE DESCRIPTION
1109001				RELE' 230 V 16 AMPERE
1109005				RELE' 230 V 16 AMPERE
1109010				RELE' 24 V 16 AMPERE
1109015				RELE' 230V 10 AMPERE
1109021				RELE' 230V 10 AMPERE
1109024				RELE' 230V 16 AMPERE

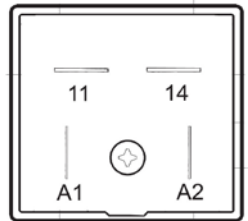
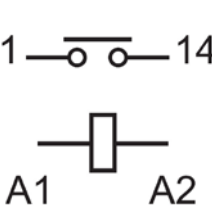
CODICE S&P S&P CODE		CONTATTI CONTACTS	SCHEMA ELETTRICO WIRING DIAGRAM	DESCRIZIONE DESCRIPTION
1109040				RELE' 230V 16 AMPERE
1109060				RELE' 230V 16 AMPERE
1109099				RELE' 230V 20 AMPERE
1109100				RELE' 230V 30 AMPERE

1109100 RELE' 30A /
RELAY 30A

1LT028: MIGEL S.R.L.

229029:

MBM- EUROTEC SRL -
DIV. COOKING
SERVICE

229029:

ELETTROBAR
DIVISIONE DELLA
EUROTEC SRL

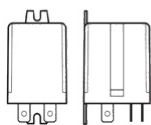
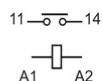

1109040 RELE
FINDER 230V 50/60HZ
GUIDA DIR /
RELAY FINDER 230V
50/60HZ

DW560301:

DIHR-ALI SPA

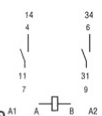

1109001 RELE' 230
16A /

RELAY 230 SILANOS

0301794:

LAMBER DI AFFABA
FRANCESCO & C.

CR0687240:

LAINOX ALI SPA

E229039:

HOBART GmbH

4271: A.T.A. SRL

905474*:

SILANOS SRL

DW16037:

DIHR-ALI SPA

229039:

ELETTROBAR
DIVISIONE DELLA
EUROTEC SRL

34200189:

RANCILIO SPA

CR0687240:

SILKO ALI SPA

4360:

UNIVER-BAR SRL

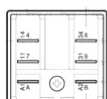
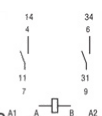

1109060 RELE' DI
POTENZA 16/250 /
RELAY 16/250

929115:

ELETTROBAR
DIVISIONE DELLA
EUROTEC SRL

34200037:

RANCILIO SPA

3222000:

ANGELO PO GRANDI

CUCINE SPA

04200046:

NUOVA SIMONELLI
SPA

DW15620:

DIHR-ALI SPA

9531505700:

GRUPPO CIMBALI SPA

33324:

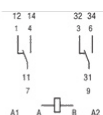

HOONVED - ALI SPA

EN125: OEM ALI SPA

34312:

HOONVED - ALI SPA

0301745:

LAMBER DI AFFABA
FRANCESCO & C.

25130100:

ELFRAMO SPA

LAR65170100:

LAINOX ALI SPA

LAR65170100:

OLIS DIVISIONE DI

ALI GROUP SPA -

DER1108:

ELETTROBAR

DIVISIONE DELLA
EUROTEC SRL

1109027 RELE'

220/50ATT/FAST.2SCA

MBI 10A /

RELAY 220/50

ATT/FAST.2 CHANGES

10A

229023:

ELETTROBAR

DIVISIONE DELLA
EUROTEC SRL

CM19620107:

SIMAG SPA

RI000761:

EURFRIGOR SRL

RI000761:

EURFRIGOR ICE

MAKERS SRL

CM19620107:

SCOTSMAN ICE SRL

CM19620107/0:

CASTEL MAC SPA

926072:

BRICE ITALIA SRL

CM19620101/0ex:

CASTEL MAC SPA

25130102:

ELFRAMO SPA

819620107:

GRUPPO CIMBALI SPA

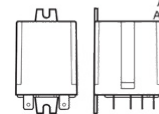

1109024 RELE'

TRIPOLARE 230V /

RELAY 230V MD80

229040:

ELETTROBAR

DIVISIONE DELLA
EUROTEC SRL

34200197*:

RANCILIO SPA

MD80: RANCILIO SPA

0301795:

LAMBER DI AFFABA
FRANCESCO & C.

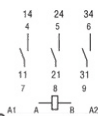

1109015 RELE' S20

220V /
RELAY S20 220V
RTFOC00144:

MBM- EUROTEC SRL -
DIV. COOKING
SERVICE

229024:

ELETTROBAR

23190:

BREMA ICE MAKERS

056510:

ELECTROLUX

085296:

ELECTROLUX

086214:

ELECTROLUX
PROFESSIONAL
S.P.A.

056466:

ELECTROLUX
PROFESSIONAL
S.P.A.

62023702:

SCOTSMAN ICE SRL

EU23190:

BRICE ITALIA SRL

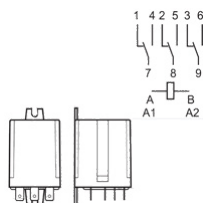
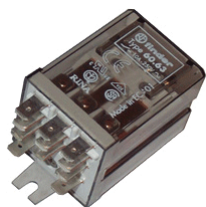

1109071 RELE' B1

230V AC-L /
RELAY B1 230V AC-L
*:

MBM- EUROTEC SRL -
DIV. COOKING
SERVICE

229008:

ELETTROBAR

DIVISIONE DELLA
EUROTEC SRL



1109046 RELE' A2-

230AC-L /
RELAY A2-230AC-L
229030:

ELETTROBAR
DIVISIONE DELLA
EUROTEC SRL



1109028 RELE'2NO16

A 230VAC + FASTON /
RELAY 2NO16 A
230VAC + FASTON

905476: SILANOS

SRL

905474EX:

SILANOS SRL

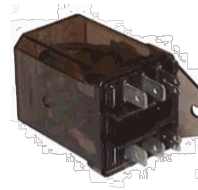

1109005 RELE'

FINDER TRIPOLARE
230V /
THREE POLAR RELAY
FINDER 230V

34200181:

RANCILIO SPA

34200192:

RANCILIO SPA

34200197:

RANCILIO SPA

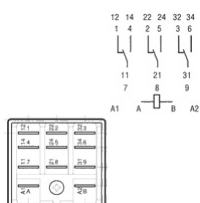
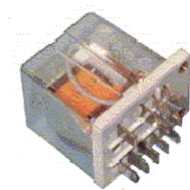

1109029 RELE' DI

POTENZA 3 SCAMBI
16A 250VAC /
POWER RELAY 3
CHANGES 16A 250VAC

905475: SILANOS

SRL

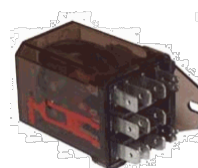

1109010 RELE'

FINDER TRIP. 62838024
24VCA /
THREE-POLAR RELAY
FINDER 62838024
24VCA

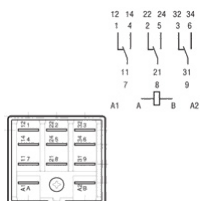
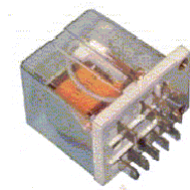

1109021 RELE' MD 50

FINDER /
RELAY MD 50 FINDER

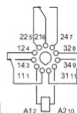
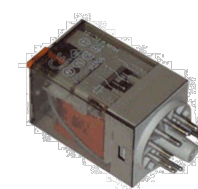

1109099 RELE 20A

230V /
RELAY 20A 230V

DER111:

COLGED

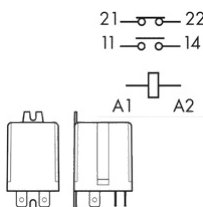
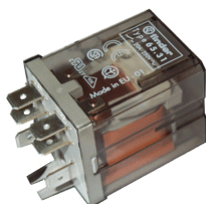

1109066 RELE

SKR115 230V CON LED
/
RELAY SKR115 230V
WITH LED

GIRR.CE VR-EV-ESP/2:

CB SRL



1109146 RELE' B2

230V AC-L /
RELE' B2 230V AC-L

229009:

ELETTROBAR

DIVISIONE DELLA
EUROTEC SRL



1109006 RITARDATO

RE 2 POMPA 220V 6" R /
"RELAY 2 PUMP 220V
6" R"

CETF604SA:

OMNIWASH SRL -
SOCIETA' A SOCIO
UNICO



1109121 "RITARDAT
ORE 2A POMPA 24V
RIT. 5-7"" 24V 62P" /
"TIME RELAY 24V RIT.
5-7"" 24V 62P""

CETF60:

**OMNIWASH SRL -
SOCIETA' A SOCIO
UNICO**



1109132 ADATTATO
RE CON BOCCOLE PER
RELE' S.62 /
ADAPTER FOR RELAY
S.62



1109126 RELE'
MICRO PORTA 30A /
POWER RELAYS 30A

**905486: SILANOS
SRL**



1109002 CONTATTO
RE 12V CIMBALI DC /
CONTACTOR 12V
CIMBALI



1109011 MINICONTA
TTTORE AB 230V NO /
MINICONTACTOR AB
230V

*****;

RANCILIO SPA

1109011: CARIMALI

HR0910: ADLER S.P.A.

9041202:

GRUPPO CIMBALI SPA

EN005: OEM ALI SPA

34200332:

RANCILIO SPA

34200219:

RANCILIO SPA

984144000:

GRUPPO CIMBALI SPA



1109042 TELERUTTO
RE A.PO 220/230 2083 /
CONTACTOR A.PO
220/230 2083

32Z2083:

**ANGELO PO GRANDI
CUCINE SPA**



1109043 TELERUTTO
RE 220/230 A.PO 2091 /
CONTACTOR 220/230
A.PO 2091

32Z2091:

**ANGELO PO GRANDI
CUCINE SPA**



1109048 TELERUTTO
RE 220-230V APO /
CONTACTOR A.PO 220-
230V

32V0980:

**ANGELO PO GRANDI
CUCINE SPA**

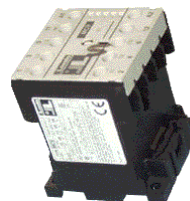

1109090 TELERUTTO
RE 230V 50-60HZ 20A
AC1

**MINICONTATTORE /
CONTACTOR 230V 50-
60HZ 20A AC1**

31873:

HOONVED - ALI SPA

355:

**ARISTARCO KASTEL
SPA**



1109102 CONTATTO
RE 230V 50HZ 4.2KW
AC3 POMPA (11BF9) /
CONTACTOR 230V
50HZ 4.2KW AC3 PUMP
(11BF9)

4375:

**ARISTARCO KASTEL
SPA**



1109098 TELERUTTO
RE 240V 50HZ NO /
RELAY 240V 50HZ NO
23594:

**BREMA ICE MAKERS
SPA**

DW15086/B:

DIHR-ALI SPA



1109112 TELERUTTO
RE /
RELAY

23147:

**BREMA ICE MAKERS
SPA**



1109141 TEL.11BG12.
01A 220-230/5060/1 /
CONTACTOR
11BG12.01A 220-
230/5060/1

CM337307120:

CASTEL MAC SPA

CM33730712:

SCOTSMAN ICE SRL



1109064 CONTATTO
RE CB /
CONTACTOR CB
GV-EV/VDE-E8P/12P-
FP-ECV/SELF-
BAKE/CHEF: **CB SRL**



1109065 CONTATTO
RE CB / CONTACTOR
CB
07070006EX: **CB SRL**
GPE 24/96P: **CB SRL**



1109020 TELERUTTO
RE 9A LC1D0900M7 /
RELAY 9A
LC1D0900M7
907190: **SILANOS
SRL**
907043*:
SILANOS SRL
120444:
COMENDA ALI SPA
E40100023:
**GIGA GRANDI
CUCINE**
6046043: **GIORIK
SPA**
00006280:
ELFRAMO SPA
120434:
COMENDA ALI SPA
907096: **SILANOS
SRL**



1109093 TELERUT.A
BB 12A 24V 50/60HZ /
CONTACTOR ABB 12A
24V 50/60HZ
120469:
COMENDA ALI SPA

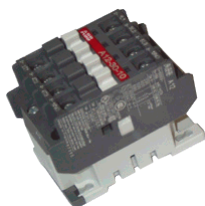

1109095 TELERUT.A
BB 26A 24V 50/60HZ /
CONTACTOR ABB 26A
24V 50/60HZ
120471:
COMENDA ALI SPA



1109159 TELERUTTO
RE 9A/16A 24V 50/60HZ
/
CONTACTOR 9A / 16A
24V 50 / 60HZ
DW2000370:
DIHR-ALI SPA



1109113 CONTATTO
RE CA4-9 10 24V
5060HZ /
CONTACTOR CA4-9 10
24V 5060HZ

927037:
ELETTROBAR
927051:
ELETTROBAR
927160:
ELETTROBAR
DIVISIONE DELLA
EUROTEC SRL
927160: **MBM**
DTC250: **COLGED**
*: **MBM- EUROTEC
SRL - DIV. COOKING
SERVICE**



1109115 CONTATTO
RE QUADRIPOLARE X5
22A /
POWER CONTACTOR
SUPPLY 230V
RESISTEVE LOAD 40A
229037:

ELETTROBAR
DIVISIONE DELLA
EUROTEC SRL
80350ex:
ELETTROBAR
DIVISIONE DELLA
EUROTEC SRL
*:
**MBM- EUROTEC SRL -
DIV. COOKING
SERVICE**
*:
**MBM- EUROTEC SRL -
DIV. COOKING
SERVICE**
73350ex:
ELETTROBAR
DIVISIONE DELLA
EUROTEC SRL



1109142 TELERUTTO
RE /
CONTACTOR
CON001:
GARBIN
INDUSTRIES SRL



1109070 TELERUTTO
RE NP 80 /
CONTACTOR NP 80
9141210:
GRUPPO CIMBALI SPA



1109076 TELERUTTO

RE 20A 230V /
CONTACTOR 20A 230V

LAR65140550:

LAINOX ALI SPA

LAR65140700:

LAINOX ALI SPA

LAR65140700:

OLIS DIVISIONE DI
ALI GROUP SPA -

R65140550:

LAINOX ALI SPA



termico=1109170

1109078 CONTATTO

RE 230V LASA /
CONTACTOR 230V
LASA

3426230: LASA SRL



1109079 RELAIS

LOVATO MC9 /
RELAY LOVATO MC9

3426100: LASA SRL

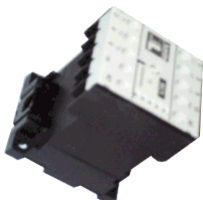

1109080 RELAIS

SIEMENS SIRIUS /
RELAY SIEMENS
SIRIUS

3421500: LASA SRL



1109122 TELERUTTO

RE 30A FRIGGITRICE /
POWER CONTACTOR
30A

537009500:

LOTUS SPA



1109049 TELERUTTO

RE 230V /
CONTACTOR 230V

180024:

MAGISTER SISTEMA
CAFFE' SRL



1109003 CONTATTO

RE 3TG USC.VITE 220V
NC /
CONTACTOR 3TG 220V
SCREW CONNECTION

CECT:

OMNIWASH SRL -
SOCIETA' A SOCIO
UNICO



1109030 CONTATTO

RE 3TG USC.VITE 24V
3TG 1001-1AC2 /
CONTACTOR 3TG
SCREW CONNECTION
24V 3TG 1001-1AC2

CECT24P:

OMNIWASH SRL -
SOCIETA' A SOCIO
UNICO



1109018 TELERUTTO

RE LS07.4.00 /
RELAY LS07.4.00

34200220:

RANCILIO SPA



1109074 CONTATTO

RE 230 V, 50/60 HZ /
CONTACTOR 230V
50/60HZ

34200285EX:

RANCILIO SPA

34200293:

RANCILIO SPA

34200260:

RANCILIO SPA

34200285:

RANCILIO SPA



1109019 TELERUTTO

RE LS4K 10-OA 220V
NO /
RELAY 3TB40 10-OA
220V

907095: SILANOS
SRL

907041: SILANOS
SRL

907043: SILANOS
SRL

34200025:

RANCILIO SPA

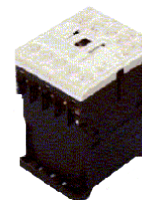

1109123 MINICONTA

TTORE 12A 24VAC /
MINICONTACTOR 12A
24VAC

EE-RA100-M12NKD3:

VELOX BARCHITTA
S.R.L.



1109017 TELERUTTO

RE TIPO MC901 22050
NC / R
ELAY TYPE MC901
22050

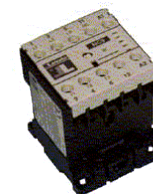

1109022 MINICONTA
TTTORE 380V 50/6 NC /
MINICONTACTOR
380V 50/6



1109041 MINICONTA
TTTORE 380V NO /
MINICONTACTOR 380V
NO



1109004 CONTATTO
RE 3TG USC. FASTON
220V /
CONTACTOR 3TG 220V
FASTON CONNECTION
CECTF:
OMNIWASH SRL -
SOCIETA' A SOCIO
UNICO



1109164 CONTATTO
RE ABB B6-30-10 220V /
CONTACTOR ABB B6-
30-10 220V
120498:
HOONVED - ALI SPA



1109092 RELE' AD
IMPULSI 130180240000 /
RELAY 130180240000
120493:
COMENDA ALI SPA



1109137 TELERUTTO
RE 4NO 24A(R) /
RELAY 4NO 24A(R)
46105100:
MODULAR SPA



1109069 RELE'
TERMICO /
RELAY
GP E/G GV: CB SRL



1109068 SUPPORTO
RELE' /
RELAY-HOLDER
GIRR.GAS -GV: CB SRL



1109094 RELE'
TERMICO ABB 0,63-1A /
RELAYS ABB 0,63-1A
120859:
COMENDA ALI SPA

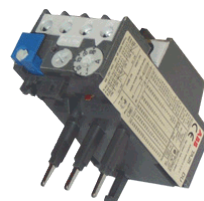

1109034 TRASFORM
ATORE 150V 220-240-
380-415/24 /
TRANSFORMER 150V
220-240-380-415/24
120608:
COMENDA ALI SPA

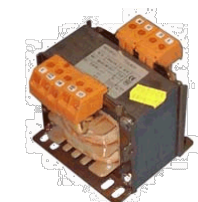

1109045 TRASF.100V
A 115/200*400-440/230 /
TRANSFORMER 100VA
115/200*400-400/230
120605:
COMENDA ALI SPA



1109062 RELE'
TERMICO P80 TRIF /
RELAY P80
9141204:
GRUPPO CIMBALI SPA



1109109 RELE' TERMI
CO ABB TA 25 DU 4,0 /
RELAY ABB TA 25 DU
4,0
35443:
HOONVED - ALI SPA

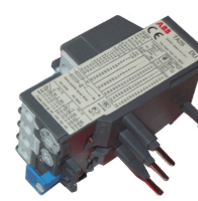

1109059 ZOCCOLO
MORSETTI /
CLAMPS CLOG

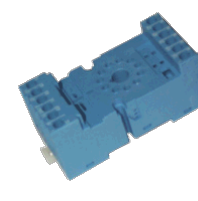

1112146 TEMPORIZZ
 ATORE 0-120" /
 TIMER 0-120"
 32Z9630:
 ANGELO PO GRANDI
 CUCINE SPA

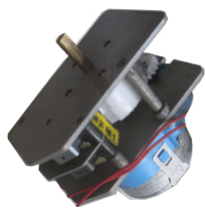

2 cammes, time 120"

1112226 CICLICO 5
 CAMME 2 MOTORI /
 TIMER 5 CAMS 2
 MOTORS
 32Z8100:
 ANGELO PO GRANDI
 CUCINE SPA



5 cammes, time 6' +
 108"

1112136 TIMER 5
 CM180"-360" A.PO /
 "TIMER 5 CAMS 180""-
 360"" A.PO"
 32Z2020:
 ANGELO PO GRANDI
 CUCINE SPA



5 cammes, time 2' + 6'

1112097 TIMER 2
 CAMME CICLO 120" /
 TIMER 2 CAMS CYCLE
 240
 1040,ALISEO422.428:
 ARISTARCO KASTEL
 SPA
 PROGRAM25CF/CFR,P
 ROJET28,GL500,GL70
 0,GL4.32,GL7,38,GL10
 40:
 ARISTARCO KASTEL
 SPA
 GL1240,PASSPORT35.
 21/38.25/40.28/45.30
 /50.32/50.35:
 ARISTARCO KASTEL
 SPA
 COMPACT20,GEMINI
 CF/CFR,MASTER
 21,MINIBAR CF/CR:
 ARISTARCO KASTEL



time 120"

1112230 TIMER CDC
 7805DV 1'2'3' 230V 50HZ
 PER GL 1040-1240 /
 TIMER CDC 7805DV
 1'2'3' 230V 50HZ FOR GL
 1040-1240
 5047:
 ARISTARCO KASTEL

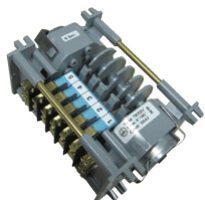

1112068 TIMER
 AL55/03/05 /
 TIMER AL55/03/05
 AL03, AL05, AL54,
 AL55, AL40D, AL45D,
 AL40, AL45,AL25:
 A.T.A. SRL
 7287EX: A.T.A. SRL
 32Z5720:
 ANGELO PO GRANDI

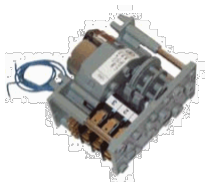

3 cammes, time 120"

CUCINE SPA
 7203EX: A.T.A. SRL

1112252 TIMER
 RIGENERAZIONE 18'
 AL11-16-21-26-AF D-
 AL55D /
 TIMER 18' AL11-16-21-
 26-AF D-AL55D
 7643: A.T.A. SRL

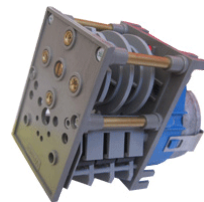

time 18', 3 cammes

1112057 TIMER AF
 DUE CICLI /
 2 CYCLES TIMER AF
 4240: A.T.A. SRL
 AF73, AF88: A.T.A.
 SRL

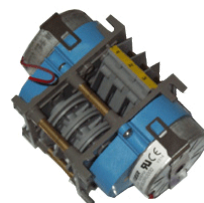

3 cammes

1112239 TIMER 220V-
 50HZ 2-4-6 MINUTI /
 TIMER 220V-50HZ 2-4-6
 MINUTES
 ALP42/P: A.T.A. SRL

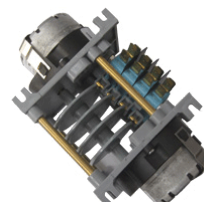

4 cammes, time 120" +
 240"+360"

1112058 TIMER AT
 220V 50HZ 60"-150" /
 "TIMER AT 220V 50HZ
 60""-150""
 AT95, AT105, AT110:
 A.T.A. SRL



4 cammes, time 216" +
 60"

1112025 TIMER TRE
 CICLI ATA /
 3 CYCLES TIMER ATA
 AT98, AT106:
 A.T.A. SRL

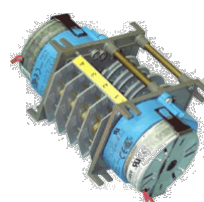

4 cammes, time 4' + 1'

1112168 TIMER 3
 CAMME 90" /
 "TIMER 3 CAMS 90""
 120228:
 COMENDA ALI SPA



3 cammes, time 90"

1112077 TIMER 120"
 3 CAMME /
 "TIMER 3 CAMS 120""

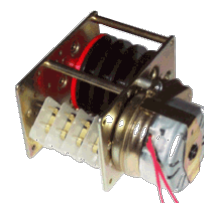

3 cammes, time 120"

1112120 TIMER P25
3CAM
120"CAM.AUTOA. /
"TIMER P25 3CAMS
120""CAM.AUTOA."
B10,B19:
COMENDA ALI SPA



3 cammes, time 120"

1112020 TIMER P25
CAM 150" COMENDA /
"TIMER P25 CAM 150""
COMENDA"
120220:
COMENDA ALI SPA



3 cammes, time 150"

1112133 TIMER P 25 3
CAMME 216"
ALB.SP.FRIZ. /
"TIMER P 25 3 CAMS
216""
B31,B32,B41,B42,F2,F3
,C33,C34:
COMENDA ALI SPA



3 cammes, time 210"

1112127 TIMER
RIGENERAZ. 20'-3
CAMME /
TIMER
REGENERATION. 20'-3
CAMS
LBR_A,LBC_A:
COMENDA ALI SPA

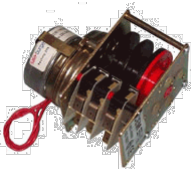

3 cammes, time 20'

1112080 TIMER
P26/15 4CR 120"-230V /
"TIMER P26/15 4CR
120""-230V"
120279: COMENDA
C48:
HOONVED - ALI SPA



4 cammes, time 120"

1112103 TIMER
SCARICO 120" B.V.S.HR
COMENDA /
"DRAIN TIMER 120""
B.V.S.HR COMENDA"
BC: COMENDA ALI
SPA



time 120", 4 cammes

1112117 TIMER IMP.4
CAM. 120" BT /
"TIMER 4 CAMS 120""
BT"
120243:
COMENDA ALI SPA
120262:
COMENDA ALI SPA

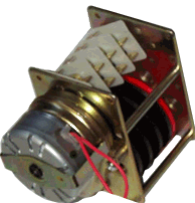

4 cammes, time 120"

1112126 TIMER IMO.
4 CAMME 150" F 45 /
"TIMER IMP. 4 CAMS
150"" F 45"
F45,LF315;
COMENDA ALI SPA
120212:

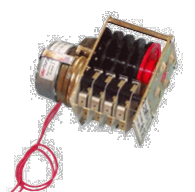

4 cammes, time 150"

COMENDA ALI SPA

1112008 TIMER 4
CAMME CICLO 360" /
"TIMER 4 CAMS CYCLE
360""
120217:
COMENDA ALI SPA

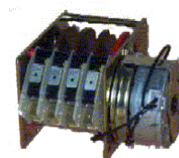

4 cammes, time 360"

1112151 TIMER 20' 4
CAMME /
TIMER 20' 4 CAMS
120214:
COMENDA ALI SPA

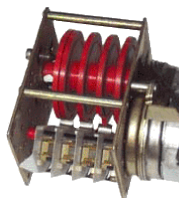

4 cammes, time 20'

1112056 TIMER
BASSO 2M. 100/150"
FC543/4 /
TIMER 2M. 100/150"
FC543/4
121208:
COMENDA ALI SPA

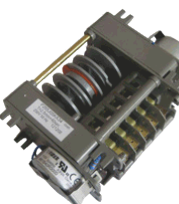

5 cammes,
time 100"/150"

1112232 TIMER 5
CAM.2MOT.100/150 F65-
/
TIMER 5 CAMS
2MOT.100/150 F65-
LF323:
COMENDA ALI SPA

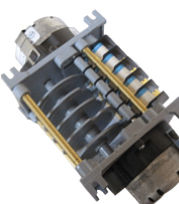

5 cammes,
time 100"/150"

1112105 TIMER
FL.BASSO120"/180"
FC54 /
"LOW TIMER FL.
120""/180"" FC54"
FC54:
COMENDA ALI SPA

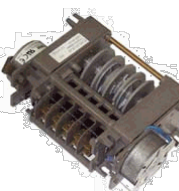

5 cammes,
time 120"+180"

1112173 "TIMER 5
CAM.2MOT.90""/120""
LF" /
""TIMER 5 CAMS
2MOT.90""/120""
LF""
120270:
COMENDA ALI SPA

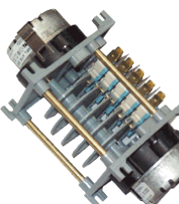

5 cammes, time 4"+120"

1112161 TIMER 5
CAM.2MOT.120/180"F55
- /
"TIMER 5 CAMS 2
MOTORS 120/180"" F55"
F55,F65,F80,LF320,LF
320A,LF323,LF323A,L
F350,LF350A:
COMENDA ALI SPA



5 cammes, time 4" +
180"

1112152 TIMER 180"
5 CAMME 2 MOTORI /
"TIMER 180"" 5 CAMS 2
MOTORS"
120256:
COMENDA ALI SPA



5 cammes, time 4" +
180"

1112102 TIMER
BASSO
RIGENER/AUTOLAV.
COMENDA /
LOW TIMER
REGENERATE/AUTOCL
EAN COMENDA
BC_HRA:
COMENDA ALI SPA

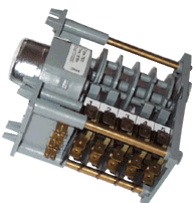

5 cammes

1112123 TIMER P25 6
CAM 2M. 75/120/180" /
"TIMER P25 6 CAMS
2M. 75/120/180""
121218:
COMENDA ALI SPA
ECOTEMP11:
COMENDA ALI SPA
DTP21:
ELETTRICITÀ
DIVISIONE DELLA
EUROTEC SRL

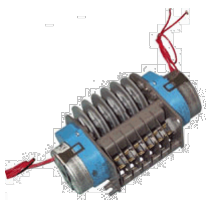

6 cammes, time 180"

1112135 TIMER
CICLO 150" BHC /
"TIMER CYCLE 150"
"BC.HR""
120297:
COMENDA ALI SPA



8 cammes

1112086 TIMER 120"
230/250 2 CAMME
AGGANCIAMENTO RAPIDO
DIHR /
"TIMER 120"" 230/250 2
CAMMS DIHR"
WY3DD010708L:
WEGA SRL
C40,DERBY,LINEAR,S
TAR,TURBO,TEKNO,G
S-
G550,G600,GASTRO4
50-900:
DIHR-ALI SPA



2 cammes, time 120"

1112293 "TIMER
120"" - 220VAC 60HZ /
TIMER 120" - 220VAC
60HZ
DW10708B:
DIHR-ALI SPA



time 120", 3 cammes

1112106 TIMER 120"
230V 50HZ
THERMOSTOP /
"THERMOSTOP TIMER
120"" 230V 50HZ "
DW10708/T:
DIHR-ALI SPA

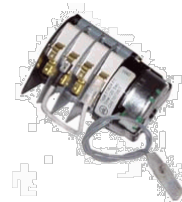

4 cammes, time 120"

1112107 TIMER 90-
180 230V/50HZ /
TIMER 90-180
230V/50HZ
DW10300123:
DIHR-ALI SPA

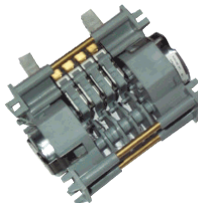

4 cammes,
time 6"+90"+180"

1112108 TIMER
60/120/180 220/50 /
TIMER 60/120/180
220/50

DW10300121ex:
DIHR-ALI SPA
DW10300122:
DIHR-ALI SPA
32V7300:
ANGELO PO GRANDI
CUCINE SPA
32V7290:
ANGELO PO GRANDI
CUCINE SPA

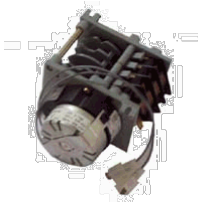

4 cammes, time 300"

1112087 TIMER
FI/7248B/64B 6"/180"
230V /
"TIMER FI/7248B/64B
6"/180"" 230V"
DW30001027:
DIHR-ALI SPA

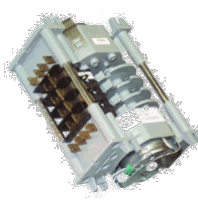

4 cammes, time 6" +
180"

1112112 TIMER 2/4 '
DIHR /
TIMER 2/4' DIHR
DW22011:
DIHR-ALI SPA

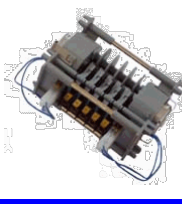

5 cammes , time 2/4'

1112015 TIMER
ZANUSSI 048881 /
CONTROLLER D94 4
CAMMS
048881:
ELECTROLUX
PROFESSIONAL
S.P.A.



4 cammes, 3 min

1112164 TIMER /
TIMER
OL3421:
ELECTROLUX
049251EX:
ELECTROLUX
PROFESSIONAL
S.P.A.



4 cammes

1112065 TIMER 50HZ

048303 /
TIMER 50HZ 048303

048303:
ELECTROLUX
PROFESSIONAL
S.P.A.

OL3642:
ELECTROLUX
PROFESSIONAL
S.P.A.



5 cammes

1112113 TIMER 50HZ

048647 /
TIMER 50HZ 048647

048647:
ELECTROLUX
PROFESSIONAL
S.P.A.

OL3674:
ELECTROLUX
PROFESSIONAL
S.P.A.



5 cammes

1112178 TIMER;

50HZ /
"TIMER; 50HZ"

049256:
ELECTROLUX
PROFESSIONAL
S.P.A.



7 cammes

1112302 \$ PROGR

270SEC HFD4M16 2C /
TIMER 270SEC
HFD4M16 2C

DTP15:
ELETTROBAR

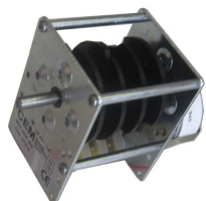

2 cammes,time 270"

1112090 TIMER 3

IMPULSI 150"
AGGRAFF.. FASTON 4,2

/"3 IMPULSES TIMER
120""

238051EX:
ELETTROBAR
65238053:
RANCILIO SPA

238053:
ELETTROBAR
D238053:
GIGA GRANDI
CUCINE SRL
238046AG:
ELETTROBAR
BETA240: COLGED

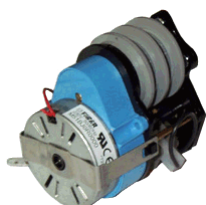

3 cammes, time 120"

1112006 TIMER 1/6'

MOD.WOLK 66 /
"TIMER 1/6""
MOD.WOLK 66"

238050:
ELETTROBAR
DIVISIONE DELLA
EUROTEC SRL



3 cammes,time 6',
=3108195, =3108196

46102900:

MODULAR SPA
238049:
ELETTROBAR
DIVISIONE DELLA
EUROTEC SRL

1112182 TIMER

CICLO PER
LAVASTOVIGLIE 4
CAMME 120" /
TIMER 230/50
60/180min/20

*:
MBM- EUROTEC SRL
- DIV. COOKING
SERVICE

238066:
ELETTROBAR
DIVISIONE DELLA
EUROTEC SRL



4 cammes, time 120"

1112092 TIMER

CICLO 60"-180" /
"CYCLE TIMER 60""-
180""

238061:
ELETTROBAR
DIVISIONE DELLA
EUROTEC SRL

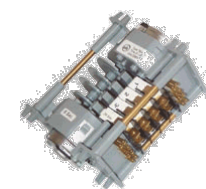

4 cammes,
time 60" + 180"

1112091 TIMER

6"/60"/180" /
"TIMER 6""/60""/180""

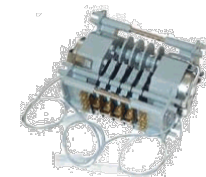

4 cammes,
time 6"+60"+180"

1112183 PROGRAMM

ATORE 1C 20' ADD.
BD14 230V /
TIMER 1C 20' ADD.
BD14 230V

26100025:
ELFRAMO SPA



1 cammes, time 20'

1112150 PROGRAMM

ATORE 4C 120" BD14 /
"TIMER 4CAMS 120""
BD14"

BD13-BD14:
ELFRAMO SPA

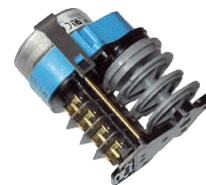

4 cammes, time 120"

1112179 PROGRAMM

ATORE 4C 180" D30
230V /
"TIMER 4C 180"" D30
230V"

809259:
EMMEPI GRANDI
CUCINE S.R.L.
D30: ELFRAMO SPA



4 cammes, time 180"

1112306 PROGRAMM
ATORE 4C LP70 -L130
230V /
TIMER 4C LP70 230
LP70: **ELFRAMO SPA**



4 cammes time 2' -7,5',

1112021 PROGRAMM
ATORE CROUZET 230V
/
TIMER CROUZET 230V
SQ42-SQ55:
ELFRAMO SPA



4 cammes

1112022 TIMER
CROUZET 5238
ELFRAMO /
TIMER CROUZET 5238
ELFRAMO
SQ120-885,SQT80:
ELFRAMO SPA



5 cammes

1112084 TIMER
2207240/50 3' 6' 9' /
TIMER 2207240/50 3' 6'
9'
238030:
ELETTROBAR

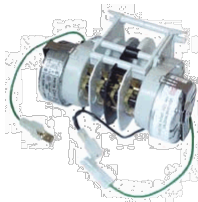

4 cammes,
time 180"+360"+540"

1112192 TIMER 2M-
5CAM.23050 1'2'3'20' /
TIMER 2M-
5KAMS.23050 1'2'3'20'
*: **MBM**
REB238073:
LOTUS SPA
REB238073: COLGED
238073:ELETTROBAR

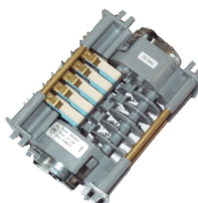

5 cammes

1112045 PROGRAMM
ATORE 5C 72/180" 230V
/
"TIMER 5C 72/180"
230V"
809247: **EMMEPI**
D40,D80,D120,C44,C6
6: **ELFRAMO SPA**

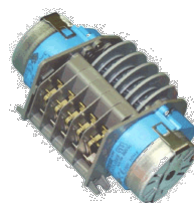

5 cammes,
time 408" + 72"

1112119 TIMER
FABAR 2 CAMME 120" /
TIMER FABAR 2
CAMMES 120"
13190: **FABAR SRL**

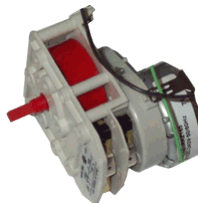

2 cammes, time 120"

1112286 TIMER
21'15" /
TIMER 21'15"
20102: **FABAR SRL**
AD0006: **ADLER S.P.A.**

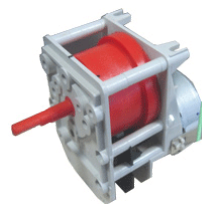

2 cammes, time 21' 15"

1112227 TIMER 120/3
AD IMPULSO /
TIMER 120/3
13190F: **FABAR SRL**
L2014: **LUXIA SRL**



3 cammes, time 120"

1112263 TIMER 180/3
AD IMPULSO /
TIMER 180/3
13190M: **FABAR SRL**



3 cammes, time 180"

1112157 PROGRAMM
ATORE 230V/50 FF+C
240" /
"TIMER 230V/50 FF+C
240"
12024087:
FAGOR
INDUSTRIALE S.R.L.
Z203030000EX:
FAGOR

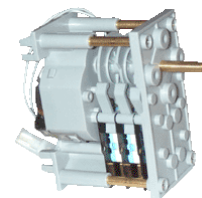

3 cammes, time 240"

1112211 TIMER
6"/120" /
TIMER 6"/120"
FI100:
FAGOR
Z713055:
FAGOR
12024571:
FAGOR



5 cammes, time 6"-120"

1112033 TIMER
CICLO P/25 79
HEMERSON /
CYCLE TIMER P/25 79
HEMERSON
*P48E,P48,NP43,P43,N
P48,NP49,NPD48,NPD
49: **GRUPPO CIMBALI**
984190000EX:
GRUPPO CIMBALI SPA
984374000:
GRUPPO CIMBALI SPA



4 cammes, time 120"

1112072 TIMER NAP
N43-45 HEMERSON /
TIMER NAP N43-45
HEMERSON
984375000:
GRUPPO CIMBALI SPA
9141040EX:
GRUPPO CIMBALI SPA



8 cammes, time 150"

1112075 TIMER 120"

220V 3 CAMME /
"TIMER 3 CAMS 120"
220V"

30347:

HOONVED - ALI SPA

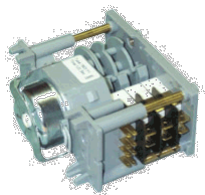

3 cammes, time 120"

1112240 TIMER 120"

220/50 V.1 GIRO /
"TIMER 120" 220/50 V.1
"

25389:

HOONVED - ALI SPA



3 cammes, time 120"

1112005 TIMER 3

CAMME CICLO 6'+
MANOPOLA /
TIMER 3 CAMS CYCLE
6'+ KNOB

25386+B07+PULSAN:

HOONVED - ALI SPA

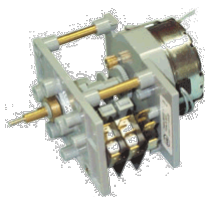

3 cammes, time 6'

1112030 TIMER

LAMBERT 6' /
TIMER LAMBERT 6'

0300807:

LAMBER DI AFFABA
FRANCESCO & C.

32529:

HOONVED - ALI SPA



3 cammes, time 180"

1112193 "TIMER CDC

4804 F1 120" 230V 4C" /
"TIMER CDC 4804 F1
120" 230V 4C"

34822:

HOONVED - ALI SPA



4 cammes, time 120"

1112249 "TIMER

120" - 220 V." /
"TIMER 120" - 220
V."

29828:

HOONVED - ALI SPA



4 cammes, time 120"

1112137 TIMER

P25/LO230 5 CAMME
3M+40S /
TIMER P25/LO230 5
CAMS 3M+40S

31054:

HOONVED - ALI SPA



5 cammes, time 3' + 40"

1112329 TIMER

P25/LO230/50 5CAM
6M+6S C98 /
TIMER P25/LO230/50
5CAM 6M+6S C98

35252:

HOONVED - ALI SPA



5 cammes, time= 6'+6"

1112228 TIMER 120

SEC. - TIMER 120 SEC. /
TIMER 120 SEC. -
TIMER 120 SEC

103500: KRUPPS S.R.L.

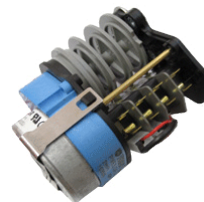

4 cammes, time 120"

1112321 TIMER 120-

240-360 SEC. /
TIMER 120-240-360 SEC.

103520: KRUPPS S.R.L.



5 cammes,
time 120"-240"-360"

1112242 TIMER 60-

90-120 SEC. PER
LAVAPIATTI A CAPOT.

/
TIMER 60-90-120 SEC.

103530: KRUPPS S.R.L.



5 cammes, time 2' + 15"

1112140 TIMER 120-

180-240 L21 /
TIMER 120-180-240 L21

0300803:

LAMBER DI AFFABA
FRANCESCO & C.

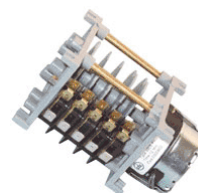

5 cammes,
time 120"-180"-240"

1112129 TIMER

LASA 6'
REG.+MANOPOLA E
TASTO /
TIMER LASA 6'
REG.+KNOB AND PUSH
BUTTON

LB95H; LASA SRL

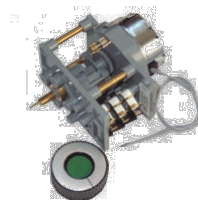

3 cammes, time 6'

1112149 TIMER 4

CAMME 2 MOTORI /
TIMER 4 CAMS 2
MOTORS

L2008: LUXIA SRL



4 cammes, time 4' + 60"

1112046 TIMER

3MIN. 230V 50HZ /
TIMER 3MIN. 230V
50HZ

1037303000:

MARENO INDUSTRIE
ALI SPA

3406031: LASA SRL



5 cammes, time 180"

1112035 TIMER
LAMBER LAVAGGIO
120" /
"WASH TIMER
LAMBER 120""
**OPT40: MODULAR
SPA**
S200:
**LAMBER DI AFFABA
FRANCESCO & C.**

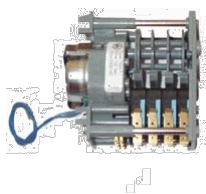

4 cammes, 120"

1112001 TIMER
CICLO FISSO 120" /
FIXED CYCLE TIMER
120"
CETF12:
**OMNIWASH SRL -
SOCIETA' A SOCIO
UNICO**



3 cammes, time 120"

1112194 "TIMER
CICLO 120"" FISSO
(BASSO) 120"" 220V
50HZ / "
CYCLE TIMER 120""
FIXED (LOW) 120""
220V 50HZ "
CETF12B:
**OMNIWASH SRL -
SOCIETA' A SOCIO
UNICO**



3 cammes,time 120"

1112048 TIMER
CICLO 150" MOD.
JOLLY /
"CYCLE TIMER 150""
MOD. JOLLY"
CETF150J:
**OMNIWASH SRL -
SOCIETA' A SOCIO
UNICO**
18011030:
**NUOVA SIMONELLI
SPA**



3 cammes, time 150"

1112016 TIMER
CICLO REGOLABILE 0-
240" /
ADJUSTABLE CYCLE
TIMER 0-240"
CETR24B:
**OMNIWASH SRL -
SOCIETA' A SOCIO
UNICO**
CETR24EX:
**OMNIWASH SRL -
SOCIETA' A SOCIO
UNICO**



3 cammes, time 4'

1112271 TIMER
CICLO 240"" FISSO
MOD. 1-2-4/82 220V /
TIMER P26 3 2402
CAMS MOD. 1-2-4/82
220V
CETF24B:
**OMNIWASH SRL -
SOCIETA' A SOCIO
UNICO**



3 cammes, time 240"

1112142 TIMER 2
TEMPI MOD.61P 90-
180SEC. 230V /
TIMER 90-120 SEC. 61P
230V
CET2C61P:
**OMNIWASH SRL -
SOCIETA' A SOCIO
UNICO**



5 cammes, time 6" +
180"

1112299 "TIMER 2
TEMPI 60-120"" 62P/S
230V 50" /
TIMER 2 TIME 60-120"
"62P / S 230V 50"
CET2C6S08:
**OMNIWASH SRL -
SOCIETA' A SOCIO
UNICO**

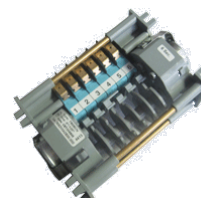

6 cammes, time 60"-
120"

1112330 TIMER 3
TEMPI MOD. 4SC 230V
50HZ /
TIMER 3 TIMES MOD.
4SC 230V 50HZ
CET3C4SC:
**OMNIWASH SRL -
SOCIETA' A SOCIO
UNICO**

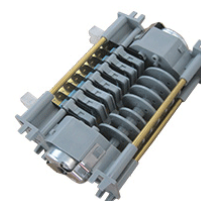

7 cammes,time= 6'+360"

1112031 TIMER 3
TEMPI MOD. 62P IME
24V /
TIMER 3 TIME MOD.
62P IME
62P:
**OMNIWASH SRL -
SOCIETA' A SOCIO
UNICO**

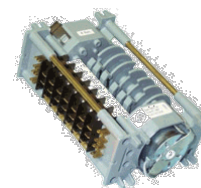

7 cammes, time 180" +
6"

1112222 "TIMER
180"" /
"TIMER 180"" 3 CAMS
**907180: SILANOS
SRL**



3 cammes,time 180"

1112095 TIMER 20'
RIGENERAZIONE /
TIMER 20'
**907173: SILANOS
SRL**



3 cammes, time 20'

1112029 TIMER 120"-
180" 2 MOTORI 220V /
"TIMER 120""-180"" 2
MOTORS 220V"
**V45,V50,600,700,800,
900,1000: SILANOS
SRL**
1112029:
BRASILIA SPA

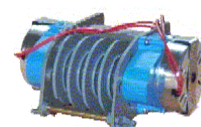

4 cammes,
time 180" + 6"

1112038 TIMER 75-120-180" 2 MOTORI 5CA / "TIMER 75-120-180" 2 MOTORS 5CA"

1330,1300S:

SILANOS SRL

1112038:

BRASILIA SPA

*:

ANGELO PO GRANDI

CUCINE SPA

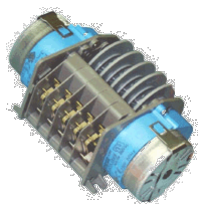

5 cammes, time 180" + 6"

1112209 PROGRAMM ATORE CICLO 150" P 350 P/400 / "TIMER 150" P 350 P/400" P 350 P/400"

30460:

SISTEMA PROJECT SERVICE SRL



2 cammes, time 150"

1112260 "PROGRAM MATORE CICLO 225" P 500" / "TIMER 225" P 500" P 500"

50460:

SISTEMA PROJECT SERVICE SRL

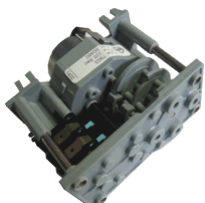

2 cammes, time 225"

1112213 TIMER UN ICA P30-40 PROJET 180" 4CM SEMIREG.230V / "TIMER UN ICA P30-40 PROJET 180" 2CM 230V"

PRGM03:

SISTEMA PROJECT UNICA P30 P40: SISTEMA PROJECT



4 cammes, time 180"

1112155 TIMER PROJECT 30450 / TIMER PROJECT 30450 30450:

SISTEMA PROJECT SERVICE SRL



5 cammes, time 120"

1112328 "PROGRAM MATORE UNICA E-S-T 120" 6 cammes / TIMER UNICA 12"-6 CAMMES

PRGM01:

SISTEMA PROJECT SERVICE SRL



6 cammes, time 120"

1112131 PROGRAMM ATORE DV 60-120-180-240 4 CAMME ST.+2 SEMIREG. / TIMER DV 60-120-180-240 4 CAMS ST.

30455:

SISTEMA PROJECT



6 cammes, time 72" + 240"

1112076 TIMER 3 CAMME 180" / "TIMER 3 CAMME 180" P 180"

SAB60:

S.V. ITALIA SRL

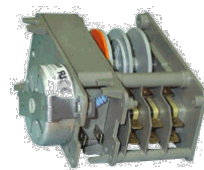

3 cammes, time 180"

1112246 TIMER CICLO 2 CAMME / TIMER 2 CAMS

4090:

UNIVER-BAR SRL



2 cammes

1112259 TIMER 2 MOTORI COMPACT OLD 60/120" / TIMER 2 MOTORS COMPACT OLD 60/120"

4516:

UNIVER-BAR SRL

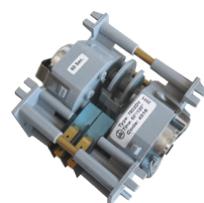

2 cammes, time 60" + 120"

1112335 Timer rigenerazione 4 cammes (modelli D) / TIMER 4 CAMMES (D TYPE)

1507:

UNIVER-BAR SRL



4 cammes, time= 120"

1112319 CICLICO PROGRAMM MINIFLEX 4905DV 5 CAMME PER LP LCF ELETTROME / CYCLIC PROGRAM MINIFLEX 4905DV 5 CAMS FOR LP LCF ELETTROME

T45-30-00001:

VELOX BARCHITTA S.R.L.



5 cammes

1112229 TIMER 72" / "TIMER 72" P 72"



2 cammes, time 72"

1112186 TIMER 4 CAMME 120 SEC. P25 / TIMER 4 CAMS 120 SEC. P25

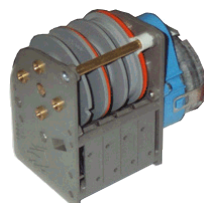

4 cammes, time 120"

1112261 PROGRAMM
ATORE 5 CAMME 2"
P255JV5A300 /
TIMER 5 CAMS 2"
P255JV5A300

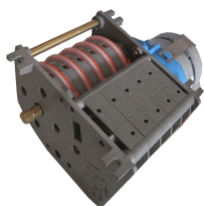

5 cammes, time 2"

1112212 TIMER 12H
230V 50Hz /
TIMER 12H 230V 50Hz

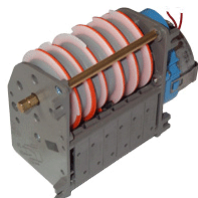

6 cammes, time 12H

1112250 PROGRAMM
ATORE A 14 CAMME
REGOLABILE 220V
50HZ DOPPIO MOTORE
/
TIMER 14 CAMS 220V
50HZ DOUBLE MOTOR



1112312 PROGRAMM
ATORE P25 /
TIMER P25



3 cammes

1112098 MOTORE
M37R SINCRONO
375RPM 50HZ 230VAC /
TIMER MOTOR M37R
375RPM 50HZ 230VAC



1112275 MOTORINO
TIMER CDC M37R
24VAC /
TIMER MOTOR CDC
M37R 24VAC



1112094 MOTORE
M37L SINCRONO
375RPM 50HZ 230VAC /
TIMER MOTOR M37L
375RPM 50HZ 230V AC



1112284 MOTORE
M42 /
MOTOR M42



1112223 MOTORINO
TIMER CDC M48R 240V
AC 50Hz /
TIMER MOTOR CDC
M48R 240V AC 50Hz
36570:



1112247 MOTORINO
TIMER M48L 230V /
TIMER MOTOR M48L
230V



1112071 MOTORINO
TIMER FIBER M61R
230V /
TIMER MOTOR FIBER
M61R 230V



1112267 MOTORINO
FIBER M61L 230V /
MOTOR FIBER M61L
230V

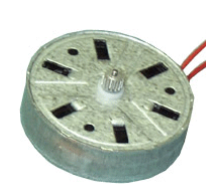

1112206 TIMER
48X48 DA PANNELLO
CON ZOCCOLO
UNDECAL /
TIMER 48X48



1112219 TEMPORIZZ
ATORE T18 V24/50
T18521202VO /
TIMER T18 V24/50
T18521202VO

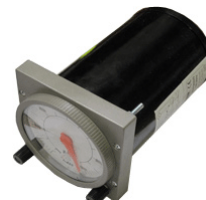

1112220 TEMPORIZZ
ATORE T18 V48/50
T18531202VO /
TIMER T18 V48/50
T18531202VO

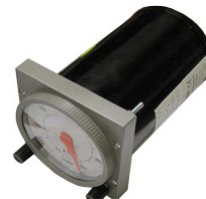

1112081 TIMER ED
700 12' 230V /
TIMER ED 700 12' 230V
25408:



1112204 TIMER
MODULARE 17,5mm X
GUIDA DIN /
TIMER 17,5mm X
GUIDE DIN

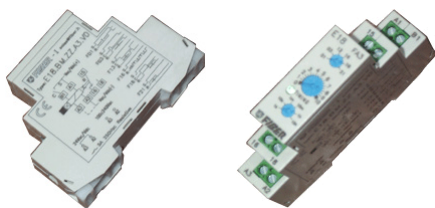

1112205 TIMER
22,5mm X GUIDA DIN /
TIMER 22,5mm X
GUIDE DIN



1112207 DISPOSITIV
O DI SICUREZZA
ARRESTO
EMERGENZA G.2 VOLT
24AC/DC /
SAFETY DEVICE G. 2
VOLT 24AC/DC



1112208 DISPOSITIV
O CONTROLLO
SEQUENZA
MANCANZA FASI /
CONTROL DEVICE



1112159 TIMER 440i
7GG 59' 12V 50HZ ITA X
6101010 E 6101011 /
TIMER 440i 7GG 59' 12V
50HZ ITA X 6101010 E
6101011



= 1112278

1112314 TIMER 740
CRONOMETRICO -ET
C/CHECK SALT 12V
50HZ - ITA /
TIMER 740 CHRONO-
METRIC -ET C / CHECK
SALT 12V 50HZ - ITA



1112278 MOTORINO
PER TIMER
ADDOLCITORI /
WATER SOFTNER
TIMER MOTOR



1114293 SCHEDA
ELETTRONICA PER
LAVAST. 230V 50/60HZ
/
P.C. BOARD 230V
50/60HZ

AL40.28:
ARISTARCO KASTEL
SPA



1114469 SCHEDA
ELETTRONICA ALISEO
40.28
/ PCB ALISEO 40.28

3303:
ARISTARCO KASTEL
SPA



1114390 SCHEDA
TIMER E. /
ELECTRONIC TIMER

15804:
ARISTARCO KASTEL
SPA

15482EX:
ARISTARCO KASTEL
SPA

AP35.21:
ARISTARCO KASTEL
SPA

10846ex:
ARISTARCO KASTEL
SPA



= 1114486

1114700 TIMER
ELETTRONICO 1-2T
ELCA /
P.C. BOARD TIMER 1-
2T ELCA

15803:
ARISTARCO KASTEL
SPA



1114148 SCHEDA
ELETTRONICA 2002 /
P.C. BOARD 2002

7771: A.T.A. SRL



1114688 SCHEDA
ELETTRONICA AL 350-
401 /
P.C. BOARD AL 350-401

8468: A.T.A. SRL



1114361 SCHEDA DI
CONTROLLO ARC 1 /
PC BOARD ARC 1

6978: A.T.A. SRL



1114063 SCHEDA
ELETTRONICA X
LE3201 /
P.C. BOARD X LE3201
121239:
COMENDA ALI SPA

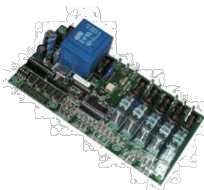

1114077 ALIMENTAT
ORE X SCHEDA ELT FC
/
FEEDER FOR
P.C.BOARD ELT FC
121216:
COMENDA ALI SPA

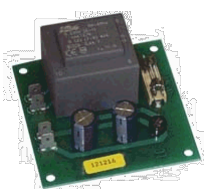

1114078 SCHEDA
ELT.COMANDI NUOVA
C COMENDA /
P.C.BOARD ELT NEW C
COMENDA
121229: COMENDA
ALI SPA

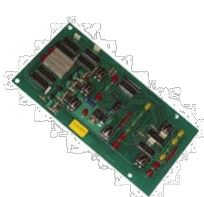

1114079 SCHEDA
PANNELLO C-G
COMENDA /
PANEL P.C. BOARD C-G
COMENDA
121267:
COMENDA ALI SPA

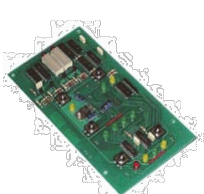

1114080 SCHEDA
ELT. BHC-HR
COMENDA /
P.C. BOARD ELT BHC-
HR COMENDA
121274:
COMENDA ALI SPA

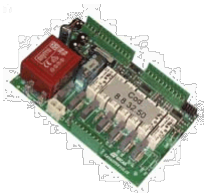

1114081 TIMER
ELETTR.UNICOM
ADDOLCITORE /
ELECTR. TIMER
UNICOM FOR WATER
SOFTENER
121237:
COMENDA ALI SPA
H121237:
HOONVED - ALI SPA

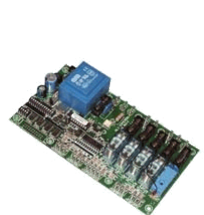

1114192 SCHEDA
COMANDI ACS/E DIGIT
/
P.C. BOARD ACS/E
DIGIT
121296:
COMENDA ALI SPA



1114224 TIMER
ELT.UNIV.G PER TAST.
/
ELECTRONIC TIMER
C60E:
COMENDA ALI SPA
C43E:
HOONVED - ALI SPA
0300828:
LAMBER DI AFFABA
FRANCESCO & C.



1114520 SCHEDA
ELT.POT.FCE /
ELECTRONIC BOARD
POWER FCE
121301:
COMENDA ALI SPA



1114369 SCHEDA
ELET.LFD/ST/E
SOFTSTART /
PC BOARD TIMER
LFD/ST/E SOFTSTART
121307:
COMENDA ALI SPA
121307:
HOONVED - ALI SPA



1114371 SCHEDA
EL.FCM SW.UNITRIG
1.08 /
PCB
121302:
COMENDA ALI SPA



1114570 SCHEDA
POTENZA HR '04 /
CARD POWER HR '04
121297:
COMENDA ALI SPA



1114459 SCHEDA
HACCP ELEMASTER /
BOARD HACCP
Elemaster
121263:
COMENDA ALI SPA

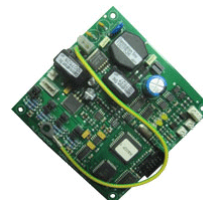

1114578 SCHEDA
TERMOREGOLATORI
7+1 /
ELECTRONIC BOARD
THERMOREGULATORS
7 + 1
121204:
COMENDA ALI SPA
H121204:
HOONVED - ALI SPA

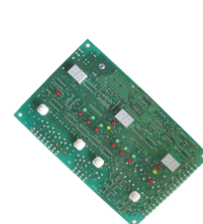

1114280 SCHEDA
MADRE ELEMMASTER /
P.C. BOARD
ELEMMASTER

121258:

COMENDA ALI SPA

H121258:

HOONVED - ALI SPA

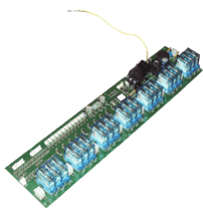

1112198 TIMER
90SEC 230V 50HZ
TERMOSTOP /
TIMER 90" 230V
THERMOSTOP

DW10708N:

DIHR-ALI SPA



1114483 TIMER
ELETTRONICO
+SCHEDA MADRE /
ELECTRONIC TIMER +
MAINBOARD

DW50580:

DIHR-ALI SPA



1114564 "SCHEDA
MADRE ""ELITE 2010
PLUS"" (BL) /
BOARD" "ELITE 2010
PLUS" "(BL)"

DW50604:

DIHR-ALI SPA



1114566 "#TIMER
ELET.""ELITE"" BA
SCHEDA MADRE" /
TIMER ELECTRIC ""
ELITE "" BA
MOTHERBOARD

DW50590:

DIHR-ALI SPA



1114534 SCHEDA
TOP/CAPOTTA PLUS
2010 (BL) / CARD TOP /
HOOD PLUS 2010 (BL)

DW11600927:

DIHR-ALI SPA



1114674 #TIMER
ELETTRON. 3/6/9 MIN.
LP2/LP3 /
ELECTRONIC TIMER
3/6/9 MIN. LP2/LP3

DW50556:

DIHR-ALI SPA



1112315 TIMER /
TIMER

0E1475:

ELECTROLUX
PROFESSIONAL
S.P.A.

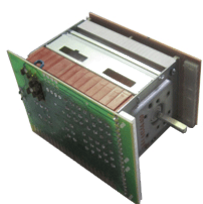

1112049 PROGRAMM
ATORE ELETTRICO
049153 /
ELECTRIC TIMER
049153

049153:

ELECTROLUX
PROFESSIONAL
S.P.A.



1114160 SCHEDA
TIMER /
TIMER P.C. BOARD

048833:

ELECTROLUX
PROFESSIONAL
S.P.A.

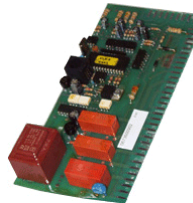

1114304 SCHEDA
TIMER /
TIMER P.C.BOARD

049412:

ELECTROLUX
PROFESSIONAL
S.P.A.

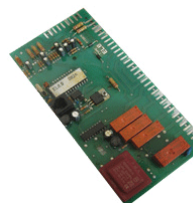

1114358 SCHEDA
TIMER /
PCB TIMER

048943:

ELECTROLUX
PROFESSIONAL
S.P.A.

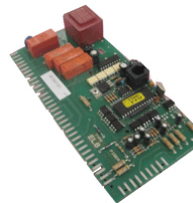

1114398 "SCHEDA
INTERFACCIA
UTENTE; LS9" /
KEYPAD PCB

0L1627:

ELECTROLUX
PROFESSIONAL
S.P.A.

0L1566:

ELECTROLUX
PROFESSIONAL
S.P.A.

0L2482:

ELECTROLUX
PROFESSIONAL
S.P.A.



1114399 SCHEDA
TIMER /
PC BOARD

048988:

ELECTROLUX
PROFESSIONAL
S.P.A.



1114121 SCHEDA
ELETTRONICA; ASSY /
PC BOARD ASSY

OL1811ex:
ELECTROLUX
PROFESSIONAL
S.P.A.
OL0705:
ELECTROLUX
PROFESSIONAL
S.P.A.
OL2583:
ELECTROLUX
PROFESSIONAL
S.P.A.
OL0541:
ELECTROLUX
PROFESSIONAL
S.P.A.

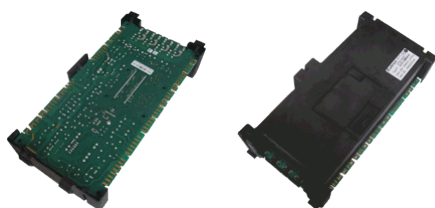

1114670 SCHEDA
ELETTRONICA
NIAGARA-OCEAN /
ELECTRONIC P.C.
BOARD NIAGARA-
OCEAN

2150341:
ELETTROBAR
DIVISIONE DELLA
EUROTEC SRL



1114671 SCHEDA
ELETTRONICA FAST
160 /
P.C. BOARD FAST 160

2150343:
ELETTROBAR
DIVISIONE DELLA
EUROTEC SRL



1114019 SCHEDA
GET.-3 E.S.
PERISTALTICO /
PERISTALTIC CIRCUIT
BOARD 3 E.S.

215010:
ELETTROBAR
DIVISIONE DELLA
EUROTEC SRL



1114672 SCHEDA
ELETTRONICA FAST
130-140-150 /
ELECTRONIC P.C.
BOARD FAST 130-140-
150

2150346:
ELETTROBAR
DIVISIONE DELLA
EUROTEC SRL



1114018 SCHEDA
GET.2.4 11.35.40.50 /
CIRCUIT BOARD 2.4
11.35.40.50

215013:
ELETTROBAR
DIVISIONE DELLA
EUROTEC SRL
215009:
ELETTROBAR
DIVISIONE DELLA
EUROTEC SRL

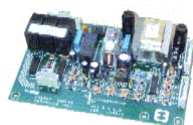

1114273 SCHEDA
GET-5/CRP /
P.C.BOARD GET 5/CRP

215025:
ELETTROBAR
DIVISIONE DELLA
EUROTEC SRL
*:
MBM- EUROTEC SRL -
DIV. COOKING
SERVICE



1114090 SCHEDA
GET 5 NIAGARA RIVER
/
P.C. BOARD GET 5
NIAGARA RIVER

215018EX:
ELETTROBAR
DIVISIONE DELLA
EUROTEC SRL
*:
MBM- EUROTEC
SRL - DIV. COOKING
SERVICE
215023:
ELETTROBAR
DIVISIONE DELLA
EUROTEC SRL
CWP2: COLGED
DES102: COLGED
215023:
MBM- EUROTEC SRL -
DIV. COOKING
SERVICE



1114405 SCHEDA
ELETTRONICA GET50 /
MAIN PC BOARD
GET50

215032:
ELETTROBAR
DIVISIONE DELLA
EUROTEC SRL



1114349 SCHEDA
CONTROLLO IGEA
ELT. LA50 IBRIDA /
ELECTROMECHANICA
L BOARD MWASH
IGEA ELT. LA50
IBRIDA

STEEL 53: COLGED
FAST135-FAST160:
ELETTROBAR
DIVISIONE DELLA
EUROTEC SRL
215029ex:
ELETTROBAR
DIVISIONE DELLA
EUROTEC SRL



1114413 SCHEDA
GET50 LA50 /
P.C. BOARD GET50
LA50

215027:

ELETTROBAR
DIVISIONE DELLA
EUROTEC SRL



1114617 SCHEDA
ELETTRONICA FAST
180 /
ELECTRONIC P.C.
BOARD FAST 180

2150345:

ELETTROBAR
DIVISIONE DELLA
EUROTEC SRL



1114389 SCHEDA
BASE DGT /
MAIN P.C. BOARD DGT

DS36DGT:

ELFRAMO SPA



1114598 SCHEDA
BASE DGT BD46 /
P.C. BOARD DGT BD46

25192041:

ELFRAMO SPA



1114495 CONTROL
UNIT (WITHOUT
EPROM /
CONTROL UNIT
(WITHOUT EPROM

8975021:

HOBART GmbH



1114698 00-897545-
005 CONTROL PCB
ECOMAX 32K /
00-897545-005
CONTROL PCB
ECOMAX 32K

8975455:

HOBART GmbH



1114336 SCHEDA
ELETTRONICA
HOBART /
P.C.BOARD HOBART



1114029 SCHEDA
ELETTRONICA
DWEDCAP 02.03.99 /
ELECTRONIC BOARD
DWEDCAP 02.03.99

34514:

HOONVED - ALI SPA

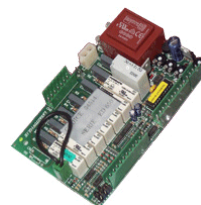

1114069 SCHEDA
ELETTRONICA
HOONVED APS43-48 /
P.C.BOARD HOONVED
APS43

33173:

HOONVED - ALI SPA

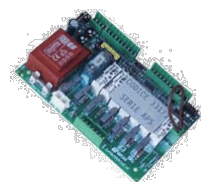

1114596 SCHEDA
ELETTRONICA HAC
swstob APE/BC /
ELECTRONIC BOARD
HAC swstob EPA / BC

121309:

HOONVED - ALI SPA



1114188 TIMER
ELT.UNIVERSALE /
UNIVERSAL PC BOARD
TIMER

121287:

HOONVED - ALI SPA

LF322:

COMENDA ALI SPA



1114165 SCHEDA
POTENZA CE-GE
HOONVED /
"ELECTRONIC PANEL
""C-GE""

121283:

HOONVED - ALI SPA



1114541 TIMER
ELETTRONICO SERIE
HC (2012) /
ELECTRONIC TIMER
SERIES HC (2012)

HC SERIES:

HOONVED - ALI SPA

HC SERIES:

HOONVED - ALI SPA



1114425 TIMER
ELETTR.2 RELE'
922117G01 /
PCB

37949:

HOONVED - ALI SPA



1114426 TIMER
UNIV.CON SOFTSTART
CAP E /
PCB
38062:
HOONVED - ALI SPA



1114253 SCHEDA
ELET.DWSC81 1.02
230401 /
PC BOARD
34749:
HOONVED - ALI SPA



1114300 SCHEDA
EL.HAC SWSTOB AP-E /
P.C. BOARD HAC
SWSTOB AP-E
38026:
HOONVED - ALI SPA



1114308 SCHEDA
ELET.EDLO 1.06 230401
/
P.C. BOARD EDLO 1.06
230401
34515:
HOONVED - ALI SPA



1114628 SCHEDA
ELETTRONICA CAP7E
(2012)RETROILLUM /
ELECTRONIC BOARD
CAP7E (2012)
BACKLIGHT
121322:
HOONVED - ALI SPA

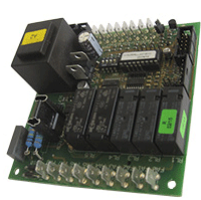

1114657 SCHEDA
ELETTRONICA C68E
SOFTST.x TAST.3 /
CIRCUIT BOARD C68E
SOFTSTARTER
121321:
HOONVED - ALI SPA



1114614 TIMER 4
RELE' (3 OPTO) /
TIMER RELAY 4 (3
OPTO)
121353:
HOONVED - ALI SPA



1114593 SCHEDA DI
POTENZA /
POWER BOARD
103700: KRUPPS S.R.L.



1114347 TIMER
ELETTRONICO
LAVASTOVIGLIE EK /
P.C.BOARD EK
0300824:
**LAMBER DI AFFABA
FRANCESCO & C.**



1114650 TERMOMET
RO DOPPIO
ELETTRONICO 230V /
DISPLAY CONTROL
PCB (THERMOMETER
DOUBLE)
0500403:
**LAMBER DI AFFABA
FRANCESCO & C.**

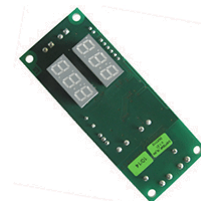

1114249 SCHEDA
ELETTRONICA
2RTMAGIC /
P.C.BOARD 2RTMAGIC
CESEM2RT:
**OMNIWASH SRL -
SOCIETA' A SOCIO
UNICO**

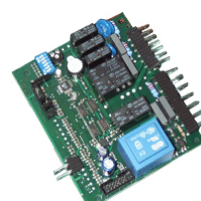

1114251 CENTRALIN
A MAGIC 35-40-50
S/ADD /
P.C.BOARD MAGIC 35-
40-50 S/ADD
CESEM2BT:
**OMNIWASH SRL -
SOCIETA' A SOCIO
UNICO**



1114477 "SCHEDA
ELETTR. ""MINI
MOLLY"" 220V BA" /
PCB ""MINI MOLLY""
220V BA"
CESEMM3500ST:
**OMNIWASH SRL -
SOCIETA' A SOCIO
UNICO**



1114343 SCHEDA
TRONIC BASE CAPOT
WHRP /
P.C. BOARD TRONIC
BASE CAPOT WHRP
**909018: SILANOS
SRL**



1114330 SCHEDA
TRONIC BASE 6 TASTI
WHRP /
P.C. BOARD TRONIC
**909012: SILANOS
SRL**



1114655 SCHEDA
TIMER TRONIC GICAR

/
PC BOARD TIMER
TRONIC GICAR

907258: **SILANOS**
SRL



1114676 TIMER
DIGIT GICAR
COMPLETO /
COMPLETE
ELECTRONIC TIMER
GICAR

907213: **SILANOS**
SRL



1114321 TIMER
TRONIC 6 TEMPI /
TIMER TRONIC 6
TIMES

907174: **SILANOS**
SRL



1114540 TIMER
TRONIC UNIFICATO
LAVATAZZINE A /
TIMER TRONIC
UNIFIED
GLASSWASHERS

907181: **SILANOS**
SRL



1114551 TIMER
TRONIC UNIFICATO
LAVAPIATTI PS /
DISHWASHER TIMER
TRONIC UNIFIED PS

907179: **SILANOS**
SRL



1114453 TIMER
TRONIC UNIFICATO
LAVATAZZINE PS /
PCB TIMER 230/240V

907178: **SILANOS**
SRL



1114510 SCHEDA
TRONIC BASE NOALIA

/
BOARD BASE TRONIC
Noalia

909348: **SILANOS**
SRL



1114470 TIMER
TRONIC UNIFICATO
LAVAPIATTI A /
ELECTRONIC TIMER
TRONIC
STANDARDISED

907169ELCA:
SILANOS SRL



907169: **SILANOS**
SRL

1114569 SCHEDA
EVO BASE GICAR 5
RELE' /

BOARD BASE EVO
GICAR 5 RELAY '

907233: **SILANOS**
SRL



1114462 SCHEDA
TRONIC BASE 3 TASTI
VT + PULSANTIERA /
PCB TRONICA BASE 3
PUSH-BUTTON VT+
PANEL

909027+909029:
SILANOS SRL
909024EX:
SILANOS SRL

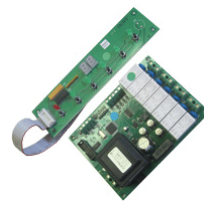

1114378 SCHEDA
TRONIC BASE 5/6
TASTI /
PCB

909027: **SILANOS**
SRL



1114660 TIMER
MULTIFUNZIONE ELI /
TIMER

MULTIFUNCTION ELI
842134: **TEIKOS SRL**
842132ex: **TEIKOS**
SRL



1114618 Timer
elettronico (modelli
Tronic) /
Electronic timer (Tronic
models)

3845:
UNIVER-BAR SRL



1114421 SCHEDA
ELETTRONICA
UNIVERBAR /
PCB WAREWASHING
UNIVERBAR

TOP-LOGOS-
COMPACT:
UNIVER-BAR SRL

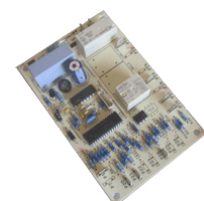

1114519 Timer
elettronico (modelli D) /
Timer elettronico (modei
D)

4851:
UNIVER-BAR SRL

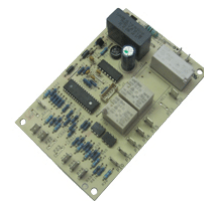

1114207 PROGRAMM

ATORE WPS 0.0 MAX.
180-265V; 50/60 HZ /
"TIMER PC.BOARD
WPS 0.0 MAX. 180-
265V; 50/60 HZ"

3105141:

WINTERHALTER
ITALIA SRL

GS302:

WINTERHALTER
ITALIA SRL

3105139:

WINTERHALTER
ITALIA SRL

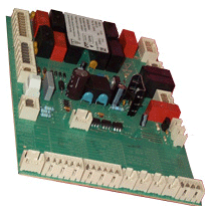

1114630 #SCHEDA

AGGIUNTIVA
FLUSSOSTATO ELITE /
ADDITIONAL CARD
FLOWMETER -Elite

DW50584:

DIHR-ALI SPA



1114656 PRESSOSTA

TO ANALOGICO 560-
AC-001 /
ANALOGICAL
PRESSURE SWITCH -
560-AC-001

224030:

ELETTROBAR
DIVISIONE DELLA
EUROTEC SRL

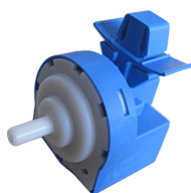

1112147 TIMER

ELETTRONICO /
ELECTRONIC TIMER

DW50553:

DIHR-ALI SPA



1114631 "SCHEDA

"TOUCHE"" 90-120-
180" /
ELECTRONIC CARD"
"Touche", "90-120-180

DW50553E:

DIHR-ALI SPA



1109016 REGOLATO

RE DI LIVELLO /
LEVEL REGULATOR

27434:

HOONVED - ALI SPA



1112301 RITARDATO

RE ELETTRONICO PER
LIVELLOSTATO /
DELAYING
ELECTRONIC LEVEL

103546: KRUPPS S.R.L.



1114373 CENTRALIN

A TIMER LAMBER /
UNIT TIMER LAMBER

0300829:

LAMBER DI AFFABA
FRANCESCO & C.



1114135 SCHEDA

ELETTRONICA GS 24 /
P.C. BOARD GS 24

3105131:

WINTERHALTER
ITALIA SRL



1114194 SCHEDA

ELETTR. DISPLAY E
TEMPI 1-2-3' SOFT-
START=ON 230V /
P.C. BOARD DISPLAY
1-2-3' SOFT-START=ON
230V

4104:

ARISTARCO KASTEL
SPA

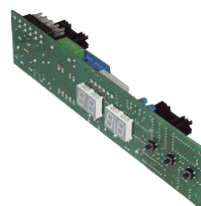

1114226 DISPLAY

PER SCHEDA
ELETTRONICA NUOVA
/

DISPLAY FOR
ELECTRONIC BOARD
6916:

ARISTARCO KASTEL
SPA

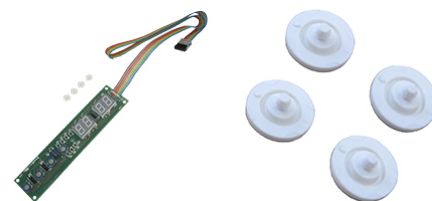

1114565 DISPLAY

COMANDI SERIE AL
NUOVA GENERAZIONE
/

DISPLAY CONTROL
SERIES AL THE NEW
GENERATION
11105:

ARISTARCO KASTEL
SPA



1114523 TASTIERA

AF /
KEYBOARD AF

5801: A.T.A. SRL



1114374 TASTIERA

AL 402-410-450 /
BUTTONS AL 402-410-
450

8403: A.T.A. SRL



1114392 DISPLAY
COMPLETO KYRA 2 /
DISPLAY KYRA 2
5917: A.T.A. SRL

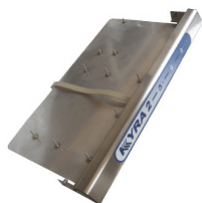

1114157 SCHEDA
ELETTRONICA CE-GE /
P.C.BOARD CE-GE
121284:
COMENDA ALI SPA
H121284:
HOONVED - ALI SPA



1114406 SCHEDA
COMANDI ACS /
ACS CONTROL BOARD
121289:
COMENDA ALI SPA

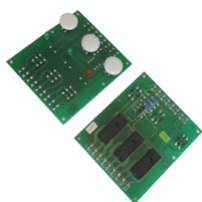

1114225 SCHEDA
TASTIERA
ELEMMASTER /
KEYBOARD PCB
ELEMMASTER
121259:
COMENDA ALI SPA
H121259:
HOONVED - ALI SPA

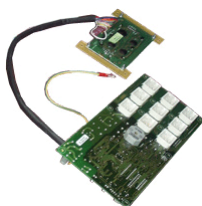

1114073 SCHEDA
COMANDI PER TIMER
ELT.ECO COMENDA /
P.C.BOARD FOR
TIMER ELT.ECO
COMENDA
121277:
COMENDA ALI SPA

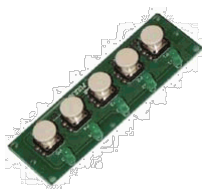

1114075 SCHEDA
ELETTRONICA FC /
P.C.BOARD FC
121210:
COMENDA ALI SPA

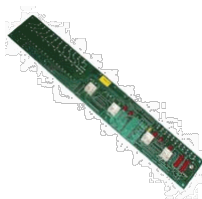

1114076 SCHEDA
ELETTRONICA FC
DUMPER /
P.C.BOARD FC
DUMPER
121211:
COMENDA ALI SPA

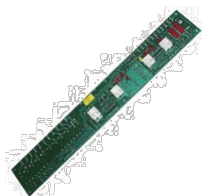

1114348 SCHEDA
ELT.COMANDI FCE /
PCB
121300:
COMENDA ALI SPA
121300:
HOONVED - ALI SPA



1114562 "PULSANTIE
RA A MEMBRANA
""ELITE 2010"" /
PANEL MEMBRANE"
"ELITE 2010" ""
DW50602:
DIHR-ALI SPA



1114567 PULSANTIE
RA A MEMBRANA
ELITE /
KEYBOARD WITH
MEMBRANE ELITE
DW50581:
DIHR-ALI SPA



1114635 TASTIERA
SCORREVOLE 2009 /
SLIDING KEYBOARD
2009
DW11600931: DIHR-
ALI SPA



1114651 TASTIERA
MEMBRANA
COMPLETA SCH.LP2-3-
4 L=1500 /
MEMBRANE
KEYBOARD
COMPLETE SCH.LP 2-3-
4 L = 1500
DW50570A:
DIHR-ALI SPA



1114227 SCHEDA
INTERFACCIA UTENTE
/
P.C. BOARD
OL1626:
ELECTROLUX
PROFESSIONAL
S.P.A.
LS5:
ELECTROLUX
PROFESSIONAL
S.P.A.



1114384 SCHEDA
INTERFACCIA
UTENTE; LS6 /
KEYPAD PCB LS6
OL1579:
ELECTROLUX
PROFESSIONAL
S.P.A.



1114542 SCHEDA
INTERFACCIA UTENTE

/
USER INTERFACE
BOARD

092700:

ELECTROLUX
PROFESSIONAL
S.P.A.



1114554 "SCHEDA
INTERFACCIA
UTENTE; LS9" /
"INTERFACE CARD
USER; LS9"

0L1235:

ELECTROLUX
PROFESSIONAL
S.P.A.

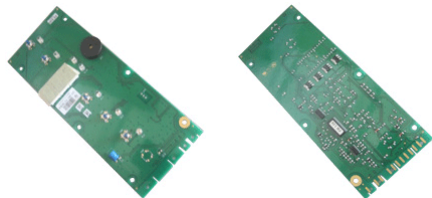

1114126 TASTIERA
COMANDI PER
LAVASTOVIGLIE /
KEYPAD PCB WITH
DISPLAY

80900:

ELETTROBAR
DIVISIONE DELLA
EUROTEC SRL

80900:

MBM- EUROTEC SRL -
DIV. COOKING
SERVICE

DES101:

COLGED

*: ELETTROBAR

80889: MBM



1114269 TASTIERA
COMANDI PER
LAVASTOVIGLIE /
KEYBOARD FOR DISH-
WASHER

41600:

ELETTROBAR
DIVISIONE DELLA
EUROTEC SRL

*:

MBM- EUROTEC SRL -
DIV. COOKING
SERVICE



1114452 PULSANTIE
RA GET50(BASSO DI
GAMMA) /
KEYPAD PCB WITH
DISPLAY

227074: ELETTROBAR



1114228 PULSANTIE
RA 4 TASTI 2 DISPLAY
X GET5 /
KEYPAD BOARD 2
DISPLAY X GET5

227084:

MBM- EUROTEC SRL -
DIV. COOKING



SERVICE

227059:

ELETTROBAR
DIVISIONE DELLA
EUROTEC SRL

*:

MBM- EUROTEC SRL -
DIV. COOKING
SERVICE

227084:

ELETTROBAR
DIVISIONE DELLA
EUROTEC SRL

1114526 SCHEDA(IE1
B)INTERF.X
PULSANT/PULS. /
BOARD (IE1B) BUTTON
INTERFACE / PULS.

215020:

ELETTROBAR
DIVISIONE DELLA
EUROTEC SRL

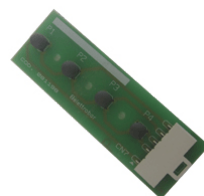

1114581 SCHEDA
COMANDI /
CONTROL CARD

227083:

ELETTROBAR
DIVISIONE DELLA
EUROTEC SRL



1114511 SCHEDA
TASTI DGT /
PUSH-BUTTONS PCB
DGT

25192030:

ELFRAMO SPA



1114667 SCHEDA
DISPLAY D40 ELT C/D
BA /
CARD DISPLAY D40
LETT C / D BA

25192210:

ELFRAMO SPA

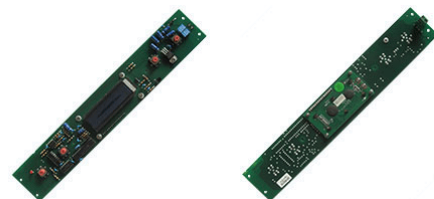

1114221 TASTIERA
COMANDI ORIZ. SERIE
C /
P.C.BOARD

C53:

HOONVED - ALI SPA

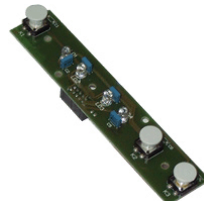

1114446 TASTIERA
COMANDI ORIZZ. CAP
/
KEYPAD PCB WITH
DISPLAY

36339:

HOONVED - ALI SPA

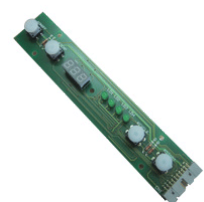

1114626 PULSANTIE
RA 4TASTI
RETROILLUMONATA
LED B /
PANEL 4 keys
BACKLIGHT LED B
121316:
HOONVED - ALI SPA



1114627 SCHEDA
DISPLAY ROSSO
TERMOME /
CARD DISPLAY RED
thermometer
121306:
HOONVED - ALI SPA



1114696 PULSANTIE
RA COMANDI HAC
VERTIC /
P.C.PANEL HAC
121304:
HOONVED - ALI SPA

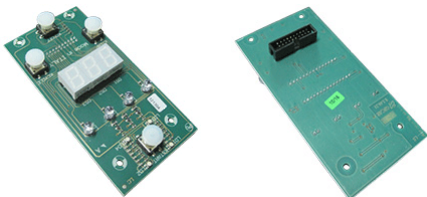

1112066 TIMER
P26/27-6CR-150"-220V /
"TIMER P26/27-6CR-
150""-220V"
32361:
HOONVED - ALI SPA



1114612 DISPLAY /
DISPLAY
103781: KRUPPS S.R.L.
103780EX:
KRUPPS S.R.L.



1114248 TASTIERA
ELETTRONICA 2 TASTI
MAGIC 35/E /
P.C. BOARD 2 PUSH
BUTTON MAGIC 35/E
CETEM2BT:
OMNIWASH SRL -
SOCIETA' A SOCIO
UNICO



1114636 "TASTIERA
ELETTRONICA ""MINI
MOLLY"" 2 TA" /
"ELECTRONIC
KEYBOARD" "MINI
MOLLY" "2 TA"
CETEM2T4L:
OMNIWASH SRL -
SOCIETA' A SOCIO
UNICO



1114591 PULSANTIE
RA EVO 40 /
BUTTON EVO 40
CETEM5T9LEVO:
OMNIWASH SRL -
SOCIETA' A SOCIO
UNICO



1114675 SCHEDA
DIGIT FRONTALE
GICAR /
FRONTAL
ELECTRONIC P.C.
BOARD GICAR
907214: SILANOS
SRL



1114463 SCHEDA
TRONIC FRONTALE 6
TASTI EL.MO /
FRONTAL PC. BOARD 6
BUTTONS
909029: SILANOS
SRL



4120114 FRONTALIN
O IN ABS II° TIPO AP
45.30, AP 50.32, AP 50 /
SWITCH PANEL AP
45.30, AP 50.32, AP 50
6202:
ARISTARCO SPA



4120053 FRONTALIN
O IN ABS I° TIPO AP
35.21 AP 38.25 AP /
CONTROL PANEL ABS
I° TYPE AP 35.21 AP
38.25 AP
6201:
ARISTARCO SPA



2105014 MEMBRANA
ADESIVA AP 35-38-40 /
FRONT FOIL L 370mm
W 60mm
10468:
ARISTARCO KASTEL
SPA



4120089 MEMBRANA
ADESIVA AL 40.28 E /
KEYPAD FOIL AL
40.28E
6424:
ARISTARCO SPA



4115936 PANNELLO
COMANDI AP 38.25 AP
SERIES /
P.C. BOARD PANEL AP
38.25 AP
10538:
ARISTARCO SPA



1114524 MEMBRANA
ADESIVA KYRA 2 /
ADHESIVE
MEMBRANE KYRA 2
5915: **A.T.A. SRL**



4120453 MEMBRANA
ADESIVA POMPA
SCARICO /
ADHESIVE
MEMBRANE PUMP
DISCHARGE
5808PS:
A.T.A. SRL

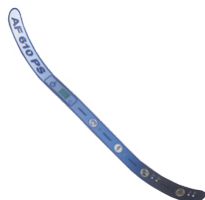

4115335 TARGA
COMENDA F.LAV LINE
/
FRONT PANEL
COMENDA
461074:
COMENDA ALI SPA



4115336 TARGA
COMANDI F50 2 TEMPI
LAV LINE /
FRONTFOIL F50
461101:
COMENDA ALI SPA



4120175 TARGA.CO
MANDI.FCM /
CONTROL PLATE -
FCM
461448:
COMENDA ALI SPA



4115342 TARGA
COMANDI C95-C155
TIMER ELT /
CONTROL PLATE C95-
C155 TIMER ELT
461193:
COMENDA ALI SPA



4115351 TARGA
COMANDI LAVAP. GL
IMB. /
DISHWASHER
CONTROL PLATE GL
IMB.
461138:
COMENDA ALI SPA



4115346 TARGA
COMANDI C166 /
CONTROL PLATE C166
461170:
COMENDA ALI SPA



4115347 TARGA
COMANDI
POLICARB.C165-2 /
POLICARB. CONTROL
PLATE C165-2
461227:
COMENDA ALI SPA



4115459 TARGA
COMANDI C 165 /
KEYPAD FOIL C165
461052:
COMENDA ALI SPA



4115961 TARGA
COMANDI C-GE ELT
2004 /
KEYPAD FOIL C-GE
ELT 2004
461353:
COMENDA ALI SPA



4120491 TARGA.CO
MANDI.ACS 91 DIGIT /
CONTROL NUMBER
PLATE ACS DIGIT 91
461362:
COMENDA ALI SPA



1114577 TARGA.CO
MANDI.ELETTRONICA
2 / ELECTRONIC
CONTROL PLAQUE 2
461078: **COMENDA
ALI SPA**



4115076 TARGA
COMANDI F45-80 ABS
600 /
FRONT PANEL F45-80
ABS 600
460850:
COMENDA ALI SPA



1114563 "MOSTRINA
TASTIERA
MEMBRANA LUX60-61-
85""ELITE""FULL" /
KEYBOARD
MEMBRANE LUX60-61-
85" "ELITE" "FULL"
DW560968:
DIHR-ALI SPA



1114600 MOSTRINA
PULSANTIERA /
faceplate BUTTON
DW560044:
DIHR-ALI SPA



4120474 PANNELLO
COMANDI /
CONTROL PANEL
DW560501:
DIHR-ALI SPA



4115845 CRUSCOTT
O SERIE K 3F+2S
GRIG.V.2001 /
DASHBOARD K 3F+2S
V.2001
135606A:
DIHR-ALI SPA



4115916 POLIESTERE
NIAGARA 51 /
POLYESTER PANEL
NIAGARA 51
25439:
ELETTROBAR
DIVISIONE DELLA
EUROTEC SRL



1114659 MASCHERIN
A POLIESTERE
NIAGARA 40 /
POLYESTER COVER
NIAGARA 40
25438:
ELETTROBAR
DIVISIONE DELLA
EUROTEC SRL



4120621 MASCHERIN
A POLIESTERE RIVER
80 /
POLYESTER MASK -
RIVER 80
80520:
ELETTROBAR
DIVISIONE DELLA
EUROTEC SRL

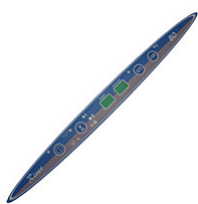

4120324 MASCHERIN
A SILVER 50 /
MASK SILVER 50
025735:
ELETTROBAR
DIVISIONE DELLA
EUROTEC SRL

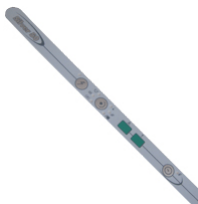

4115976 MASCHERIN
A POLIESTERE U61E /
KEYPAD FOIL
U61E:
ELETTROBAR
DIVISIONE DELLA
EUROTEC SRL

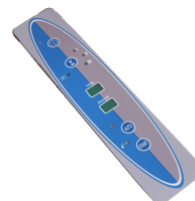

1114488 "PULSANTI;
KIT; B3M" /
BUTTONS, KIT, B3M
0D5241:
ELECTROLUX
PROFESSIONAL
S.P.A.

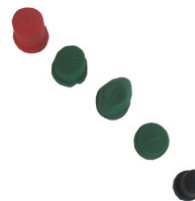

4120374 POLIESTERE
RIVER 252(LA50) /
PANEL POLYESTER 252
RIVER (LA50)
*:
EUROTEC SRL - DIV.
COOKING SERVICE
MBM
05944:
ELETTROBAR
DIVISIONE DELLA
EUROTEC SRL



4115911 MASCHERIN
A (BLUEWASH1200)
UDEX /
KEYPAD FOIL
(BLUEWASH1200)
80544:
ELETTROBAR
DIVISIONE DELLA
EUROTEC SRL



4120183 MASCHERIN
A GL71 /
KEYPAD FOIL GL71
80300:
ELETTROBAR
DIVISIONE DELLA
EUROTEC SRL



4120184 MASCHERIN
A GL72 /
KEYPAD FOIL GL72
80301:
ELETTROBAR
DIVISIONE DELLA
EUROTEC SRL



4120493 CRUSCOTT
O COMPLETO NFS 70 /
DASHBOARD
COMPLETE NFS 70
977529000:
GRUPPO CIMBALI SPA



4120409 OPERATION
UNIT /
OPERATION UNIT
8975011:
HOBART GmbH



1114604 TARGA
COMANDI CAP 12 '09 /
PLATE CONTROL CAP
12 '09
38116:
HOONVED - ALI SPA



4120617 TARGA
COMANDI CAP7E 2011 /
PLATE CONTROL
CAP7E 2011
463295:
HOONVED - ALI SPA



4120219 TARGA
COMANDI C - E /
KEYPAD FOIL C-E
463298:
HOONVED - ALI SPA
36134ex:
HOONVED - ALI SPA



4120595 TARGA
COMANDI C 48 /
COMMANDS PLAQUE
C 48
33715:
HOONVED - ALI SPA



4120438
CRUSCOTTO C 35 CPL
SERIGRAFATO /
PANEL C 35 CPL
SILKSCREENED
34141:
HOONVED - ALI SPA



4120702 TARGA
COMANDI C 60 /
CONTROL PLATE C 60
35926:
HOONVED - ALI SPA
33719ex:
HOONVED - ALI SPA



4120514 TARGA
COMANDI C 43 /
PLAQUE CONTROL C
43
33713:
HOONVED - ALI SPA



4120672 "TARGHETT
A SERIGR. 21X149
""MAGIC 35"" /
PLATE SILKSCREENED
21X149 MAGIC 35
AMOTS21149MEB:
OMNIWASH SRL -
SOCIETA' A SOCIO
UNICO



4120494 PANNELLO
COMANDI 62P/S ABS
BLUE /
CONTROL PANEL 62P /
S ABS BLUE
CEPC6214S:
OMNIWASH SRL -
SOCIETA' A SOCIO
UNICO



4120567 PANNELLO
COMANDI
(+CABLAGGIO) 62P/S
GR. /
CONTROL PANEL (+
WIRING) 62P / S GR.
CEPC6214S05C:
OMNIWASH SRL -
SOCIETA' A SOCIO
UNICO



4120659 PANNELLO
COMANDI 62P/S ABS
GRIGIO (/
CONTROL PANEL 62P/S
ABS GREY
CEPC6214S05:
OMNIWASH SRL -
SOCIETA' A SOCIO
UNICO



4120233 PANNELLO
COMANDI 61P ABS
RAL 8019 /
CONTROL PANEL
CEPC6214P1:
OMNIWASH SRL -
SOCIETA' A SOCIO
UNICO



4120418 "PANNELLO
COM. MOD. 1""Q""
GRIGIO" /
"CONTROL PANEL
MOD. 1" "Q" "GREY"
CEPC1D25Q6R:
OMNIWASH SRL -
SOCIETA' A SOCIO
UNICO



4120417 "PANNELLO
COM. MOD. 1""R""
GRIGIO" /
"CONTROL PANEL
MOD. 1" "R" "GREY"
CEPC6214S6R12C:
OMNIWASH SRL -
SOCIETA' A SOCIO
UNICO



4120485 "PANNELLO
COM. 5 ""R"" GRIGIO
RAL 7011" /
PANEL COM. 5" "R"
"GREY RAL 7011
CEPC5D25RGR:
OMNIWASH SRL -
SOCIETA' A SOCIO
UNICO



1114178 EPROM
COMENDA 120947 /
EPROM COMENDA
120947
120947:
COMENDA ALI SPA



1114449 MICROPROC
ESSORE U61E /
EPROM TYPE U61E
81001:
ELETTROBAR
DIVISIONE DELLA
EUROTEC SRL



1114451 MICROPROC
ESSORE GET.5 T.D. /
MICROPROCESSOR
GET.5 T.D.
225031:
ELETTROBAR
DIVISIONE DELLA
EUROTEC SRL



1107202 MICROPROC
ESSORE (GET5300)
STEEL70/RANCILIO /
MICROPROCESSOR
(GET5300)
STEEL70/RANCILIO
81016:
ELETTROBAR
DIVISIONE DELLA
EUROTEC SRL



1114496 EPROM
REV. 10.4 /
EPROM REV. 10.4
8975032:
HOBART GmbH



1114609 SCHEDA
LAVAVERDURE /
BOARD Vegetable washer
32Z3030: FIMAR
S.P.A.
32Z3030:
ANGELO PO GRANDI
CUCINE SPA

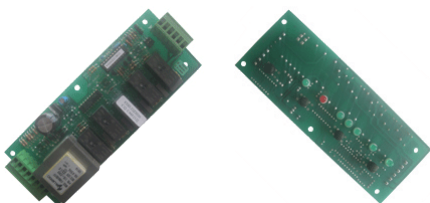

1114691 SCHEDA
ELETTRONICA DI
POSIZIONAMENTO PER
F79 /
F79 POSITIONING P.C.
BOARD

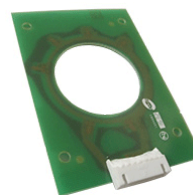

1114130 REGOLATO
RE ELETTR.
PRESSIONE
EASYPRESS 16A 12m3/h
/
PRESSURE ELECTR.
REGULATOR
EASYPRESS 8A 10m3/h



1114454 4 POLES
CONNECTOR /
4 POLES CONNECTOR
CM81453826:
SCOTSMAN ICE SRL

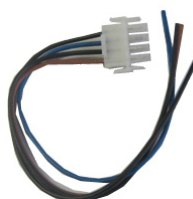

1114538 FUSIBILE
4A TIMER
ELETTRONICO /
FUSE 4A ELECTRONIC
TIMER
907116: SILANOS
SRL



1129018 SONDA
AUTOLIVELLO 125MM
/
AUTOLEVEL BORE
125MM
20251:
CMA MACCHINE PER
CAFFE' SRL

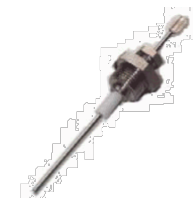

1129287 SONDA DI
SICUREZZA
COMPLETA /
COMPLETE SECURITY
PROBE
793103610: GICO SPA



1129288 ASSIEME
SONDA LIVELLO /
COMPLETE LEVEL
PROBE
793103600: GICO SPA



1129274 ASSIEME
SONDA SERIE AL
(SENSORE) /
ASSEMBLY SERIES
PROBE AL (SENSOR)

6984:

ARISTARCO KASTEL
SPA



1129292 "SENSORE
LIVELLO ACQUA;
ASSY COMPLETE" /
WATER LEVEL
SENSOR, ASSY
COMPLETE

091012:

ELECTROLUX
PROFESSIONAL
S.P.A.



1129034 SONDA
LIVELLO /
LEVEL BORE

25042:

HOONVED - ALI SPA



1129218 SONDA LIV.
VASCA ED 650 C81/90 /
LEVEL ELECTRODE ED
650 C81/90

33431:

HOONVED - ALI SPA

35361:

HOONVED - ALI SPA



1129301 SONDA
CURVATA A 60° /
BORE 60°

32311:

HOONVED - ALI SPA



1129045 SONDINA
CURVATA COMPLETA
60°X APS-APSE
HOONVED /
COMPLETE BORE 60°X
APS-APSE HOONVED



NUT=1141512,
GASKET=2102899

1129183 SENSORE
LIVELLO DETERSIVO
LP /
SENSOR, WATER
LEVEL FOR
DETERGENT LP

SENSORELIVELLODE:

VELOX BARCHITTA
S.R.L.



1129273 SONDA
TERMOSTATICA
DIGITALE SERIE AL /
PROBE THERMOSTAT
DIGITAL SERIES AL

6902:

ARISTARCO KASTEL
SPA



1129228 SONDA PTC
TERMOSTATO
LAVASTOVIGLIE
ELETTRONICA /
TEMPERATURE
PROBE PTC

7723: A.T.A. SRL



1129131 SONDA PTC
SCHEDE
ELETTRONICHE F-C /
PROBE PTC P.C.BOARD
F-C

120913:

COMENDA ALI SPA



1129252 SONDA NTC
+ BLOCCHETTO /
NTC PROBE + BLOCK

120960:

COMENDA ALI SPA

H120960:

HOONVED - ALI SPA



1129132 SONDA
TEMPERATURA NTC
900750 /
TEMPERATURE PROBE
NTC 900750

120952:

COMENDA ALI SPA



1129160 SONDA
PT100 X ELETTRONICA
7MT. /
PROBE PT100 X
ELECTRONIC 7MT.

120910:

COMENDA ALI SPA



1129213 SONDA PER
SCHEDE ELETTRON.
LP2/LP3 /
PROBE FOR PCB
LP2/LP3

DW50563:

DIHR-ALI SPA



1129139 SONDA
TEMPERATURA GET-5
/
TEMPERATURE PROBE
GET-5

231014:

ELETTROBAR

DIVISIONE DELLA



EUROTEC SRL
231016:
ELETTROBAR
DIVISIONE DELLA
EUROTEC SRL

1129244 TEMPERAT
URE SENSOR /
TEMPERATURE
SENSOR
7756121:
HOBART GmbH



1129137 SONDA
TEMP.NTC 3.3K
GIALLA+MICROP.DWS
AP /
YELLOW
TEMPERATURE PROBE
NTC
3.3K+MICROP.DWSAP
35567+35562:
HOONVED - ALI SPA

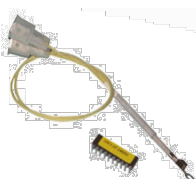

1129260 FILI
COLLEGAMENTO
SONDE LIVELLO
VASCA.C90 E /
WIRES CONNECTION
PROBES LEVEL TANK
C90 E
36690:
HOONVED - ALI SPA



1129264 SONDA DI
TEMPERATURA
VASCA/BOILER
L=1660MM /
TEMPERATURE PROBE
TANK / BOILER L =
1660MM
103770: KRUPPS S.R.L.



1129285 SONDA
T1/T2 (NTC2K) PER
LD2/LCD32 (NTC 2MT) /
PROBE T1 / T2 (NTC2K)
FOR LD2 / LCD 32 (NTC
2 MT)
02128300R:
MBM- EUROTEC SRL -
DIV. COOKING
SERVICE



L=2000mm

1129203 SENSORE
TEMPERATURA
VASCA - BOILER D.6,5
X 25 /
BOILER/TANK
TEMPERATURE
SENSOR D. 6,5X25
CE5TVBJ:
OMNIWASH SRL -
SOCIETA' A SOCIO
UNICO
CECSVBMex:
OMNIWASH SRL



1129210 SONDA
TRONIC /
TRONIC PROBE
909364:
SILANOS SRL



1129286 SONDA
SCHEDA EVO GICAR
1700mm COMPLETA /
PROBE PC-BOARD -
EVO GICAR 1700mm
COMPLETE
907235:
SILANOS SRL



PRESSOSTATI / PRESSURE SWITCH

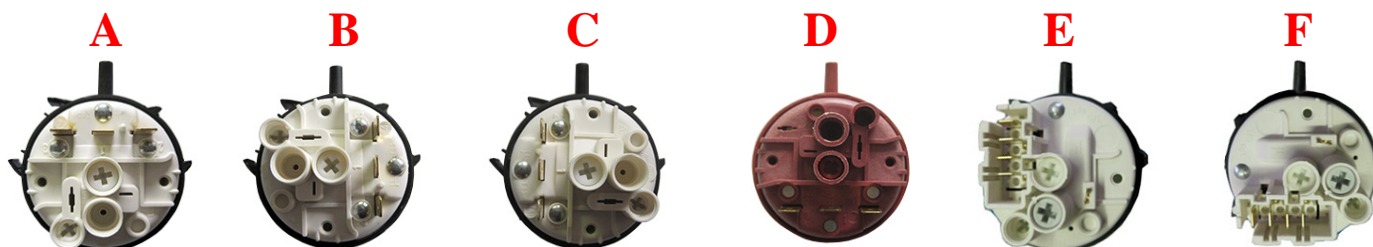

S&P CODE	CAMPO DI LAVORO RANGE OF WORK	TYPE	S&P CODE	CAMPO DI LAVORO RANGE OF WORK	TYPE	S&P CODE	CAMPO DI LAVORO RANGE OF WORK	TYPE
1113030	28-12	A	1113060	60-25	A	1113027	110-70	A
1113092	30-90	A	1113026	60-30	A	1113057	110-75	A
1113056	35-17	A	1113043	60-40	B	1113085	115-15	A
1113013	35-90	B	1113151	65-10	A	1113009	123-75	A
1113101	40-15	F	1113042	70-30	B	1113102	125-102	A
1113012	40-20	A	1113010	70-35	A	1113077	150-75	A
1113039	46-30	B	1113040	70-40	B	1113019	160-80	D
1113032	48-28	B	1113052	75-45	B	1113105	165-140	A
1113004	50-20	A	1113066	76-38	A	1113086	170-140	A
1113146	55-20	A	1113053	80-50	A	1113055	180-70	B
1113011	55-22	D	1113062	83-33	B	1113051	190-80	B
1113008	55-30	A	1113034	86-59	A	1113006	240-130	D
1113059	55-35	A	1113135	90-56	A	1113035	250-40	A
1113002	56-25	A	1113142	100-40	A	1113064	250-130	E
1113037	60-20	B	1113045	110-40	C	1113106	260-135	B
1113065	60/20-110	E	1113041	110-60	A			

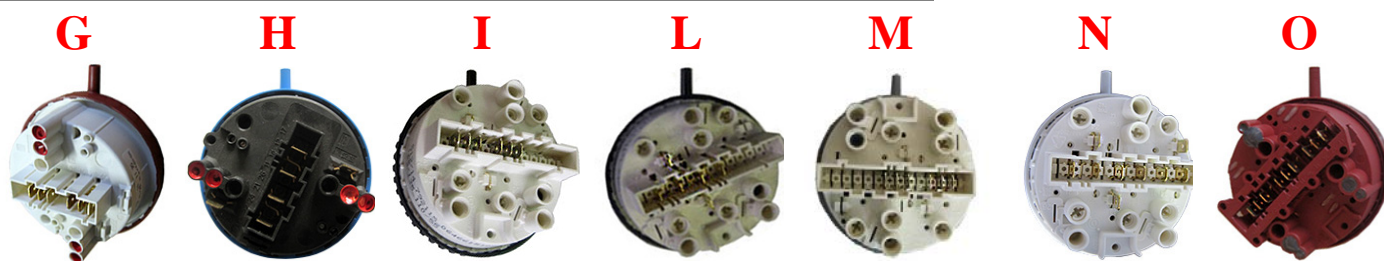

S&P CODE	CAMPO DI LAVORO RANGE OF WORK	TYPE	S&P CODE	CAMPO DI LAVORO RANGE OF WORK	TYPE	S&P CODE	CAMPO DI LAVORO RANGE OF WORK	TYPE
1113078	2L 25-12, 50-30	G	1113120	2L 40-15, 55-35	L	1113036	3 L 50-30, 30-50,160-80	N
1113025	2L 70-40, 90-70	H	1113088	2L 110-80, 60-20	M	1113031	3L 50-30, 50-30,110-70	N
1113050	2L 100-52, 130-100	H	1113089	2L 110-80, 60-20	M	1113114	3L 40-25, 92-77,160-140	O
1113082	2L 165-135, 110-55	I						

1113020 PRESSOSTA
TO 0,5-1,2 -1/4" /
"PRESSURE SWITCH
0,5-1,2 -1/4""



1113046 PRESSOSTA
TO 1/8" GAS 0,9-1,5 BAR
UL (pret. 1,2 bar) /
"PRESSURE SWITCH
1/8"" GAS 1-2,5 BAR
UL"

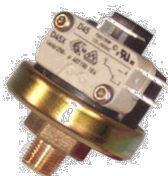

1113090 PRESSOSTA
TO
ACQUA+CAPPUCCIO
0,2-3 BAR /
WATER PRESSURE
SWITCH + CAP
3041830:
**ANGELO PO GRANDI
CUCINE SPA**



1113153 SENSORE
ETX165 16BAR 1/4"
GAS INOX /
SENSOR ETX165 16BAR
1/4" GAS INOX



L=800mm

1113119 PRESSOSTA
TO LAVAGGIO 4BAR /
PRESSURE CONTROL
4BAR
3004461:
**ANGELO PO GRANDI
CUCINE SPA**



1113123 "PRESSOST
ATO; GP600" /
PRESSURE SWITCH;
GP600
0C6217:
**ELECTROLUX
PROFESSIONAL
S.P.A.**



1113033 PRESSOSTA
TO N.C. 4,5MB
COMENDA /
PRESSURE SWITCH
N.C. 4,5MB COMENDA
**FC54LBT,LC380BT,LF3
20BT,LF320CBT,LF32
0LBT,LP360BT:**
COMENDA ALI SPA
**C155BT,C165ELBT,C16
6-
2,C75BT,C95BT,FC53B
T,FC53LBT,FC54CBT:**
COMENDA ALI SPA



802141005: FAEMA
30687: HOONVED
9141005:
GRUPPO CIMBALI SPA
37822: HOONVED
984149000:
GRUPPO CIMBALI SPA

1113103 PRESSOSTA
TO LINEARE 0-30
MBAR /
PRESSURE SWITCH 0-
30 MBAR
DW540205:
DIHR-ALI SPA



1113113 PRESSOSTA
TO
ANALOGICO(SCHEDIN
A)LA50 /
ANALOG SWITCH
(ROLL) LA50
999328:
ELETTROBAR
**DIVISIONE DELLA
EUROTEC SRL**
224018ex:
ELETTROBAR
**DIVISIONE DELLA
EUROTEC SRL**

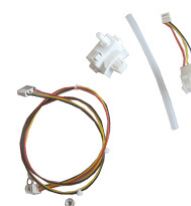

1113121 LIVELLOST
ATO ORIZZONTALE /
LEVEL SWITCH
HORIZONTAL
103385: KRUPPS S.R.L.



1113122 REGOLATO
RE PRESSIONE FGMD
MW5208001 /
PRESSURE
REGULATOR FGMD
MW5208001
RTFOC00624:
**MBM- EUROTEC SRL -
DIV. COOKING
SERVICE**



1113134 KIT
PRESSOSTATO ARIA
HUBA /
KIT AIR PRESSURE
SWITCH HUBA
6300569:
**ANGELO PO GRANDI
CUCINE SPA**



4120020 FLUSSOSTA
TO X SCHEDA ELITE /
FLOW REGULATOR
FOR P.C. BOARD ELITE
DW50583:
DIHR-ALI SPA



1113147 PRESSOSTA
TO ANALOGICO /
ANALOGICAL
PRESSURE SWITCH

224999:

ELETTROBAR
DIVISIONE DELLA
EUROTEC SRL



1113131 PRESSURE
TRANSMITTER /
PRESSURE
TRANSMITTER

7758662:

HOBART GmbH



1113144 "PRESSOST
ATO: 0.3-0.8 BAR;
250V" /

STEAM PRESSURE
SWITCH 0.3-0.8 BAR

0C3190EX:

ELECTROLUX
PROFESSIONAL
S.P.A.

0A2480:

ELECTROLUX
PROFESSIONAL
S.P.A.



1124007 ELETTROVA
LVOLA 1 VIA 90° D.10,5

/
SOLENOID VALVE 1
WAY 90° D. 10,5

120145: COMENDA

ALI

394: ARISTARCO

AL10, AL20, AL03,

AL54, AL55, AF73,

AF88: A.T.A. SRL

240006: ELETTROBAR

1037308800:

MARENO

DEV3S: COLGED

B100,B303,CF35,CF40:

ADLER S.P.A.

3306510: LASA SRL

926035:

BRICE ITALIA SRL

RF00A581:

EURFRIGOR



1124183 EL.VALV.H2
0 S.LT.0,5 -220/50 1VIA
90° /

SOLENOID VALVE 1
WAY 90° H20 LT.0,5
220/50

23497: BREMA ICE

N23497: N.T.F. SRL



1124006 ELETTROVA
LVOLA 1 VIA 90° 1,2L /
SOLENOID VALVE 1
WAY BREMA

68023001: RANCILIO

23001: BREMA ICE

926132: BRICE

ITALIA



1124179 ELETTROVA
LVOLA 1 VIA 90° 230V
1,2L /

SOLENOID VALVE 1
WAY 90° 230V 1,2L



1124151 ELETTROVA
LVOLA 1V-90°220/240
16mm /

SOLENOID VALVE 1
WAY 90° 220/240 16mm



1124363 ELETTROVA
LVOLA 1 VIA 220V 90°
D.10.5 BASSA

TEMPERATURA /
SOLENOID VALVE 1
WAY 90° D. 10.5 230V

LOW TEMPERATURE



1124175 ELETTROVA
LVOLA INGRESSO
ACQUA A 1 VIA /
SOLENOID VALVE 1
WAY

23220: BREMA ICE

RF000624: BRICE

1185003E: MONDIAL

926034: BRICE

ITALIA



1124250 ELETTROVA
LVOLA INGRESSO
ACQUA A 1 VIA 90° /
SOLENOID VALVE 1
WAY 90°

23623: BREMA ICE



1124347 ELETTROVA
LVOLA 1 VIA 8 LT.
220/50-60 /

SOLENOID VALVE 1
VIA 8 LT. 220 / 50-60

23819: BREMA ICE



1124173 ELETTROVA
LVOLA 1 VIA LT0,8
220/50-60-UL /
SOLENOID VALVE 1
WAY LT0,8 220/50-60-
UL
G500A: BREMA ICE
K01212: ARISTARCO



1124346 ELETTROVA
LVOLA /
SOLENOID VALVE
62021301:
SCOTSMAN ICE SRL



1124232 ELETTROVA
LVOLA INGRESSO
ACQUA A 1 VIA /
SOLENOID VALVE 1
WAY
23787:
BREMA ICE MAKERS



1124064 ELETTROVA
LVOLA 1 VIA 90° D.10,5
24V /
SOLENOID VALVE 1
WAY 90° D. 10,5 24V
0L0175: ELECTROLUX
OH2513: ELECTROLUX



1124030 ELETTROVA
LVOLA 1 VIA 90° D.13,5
/
SOLENOID VALVE 1
WAY 90° D. 13,5



1124155 ELETTROVA
LVOLA ELBI 1VIA 90°
230V 13,5 /
SOLENOID VALVE 1
WAY 90° 230V D.13,5
ELBI



1124086 ELETTROVA
LVOLA 1 VIA D. 13,5
90° 24V /
SOLENOID VALVE 1
WAY D. 13,5 90° 24V



1124111 ELETTROVA
LVOLA 1VIA 90° D.13,5
24V /
SOLENOID VALVE 1
WAY 90° D. 13,5 24V



1124327 Elettrovalvola
ingresso acqua a 1 via
110V /
Solenoid water inlet 1
outlet 110V
23410:
BREMA ICE MAKERS



1124009 ELETTROVA
LVOLA 2 VIE 90° D.
10,5 /
SOLENOID VALVE 2
WAYS 90° D. 10,5
RF000625:EURFRIGO
R

120142:COMENDA
ALI
AL30, AL40, AL35,
AL45, AL50, AL60,
AL11, AL21, AL15,
AL25, AL54D, AL55D,
AF61, AF78, AL16,
AL26, AL05,
AL40/46/05-D:
A.T.A. SRL
B100, B303, CF35,
CF40: ADLER S.P.A.

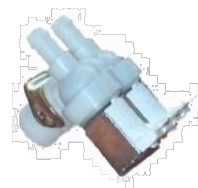

1124191 EL.
VALVOLA H20 D. LT
0,8/0,8 /
SOLENOID VALVE H20
D. LT 0,5/0,5
SL35: N.T.F. SRL
CB184: BREMA ICE
926137: BRICE
ITALIA



1124159 ELETTROVA
LVOLA INGRESSO
ACQUA A 2 VIE 0,8/0,8
L AL MINUTO /
SOLENOID VALVE 2
WAYS 0,8/0,8 L
23116: BREMA ICE
K01045: ARISTARCO



1124004 ELETTRIV.
2 VIE 23010 /
SOLENOID VALVE 2
WAYS ICEBOX BREMA
926133: BRICE
ITALIA
23010: BREMA ICE

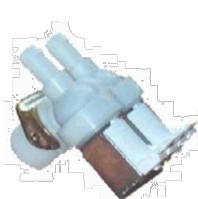

1124125 ELETTROVA
LVOLA DOPPIA
BREMA 23542 /
DOUBLE SOLENOID
VALVE BREMA 23542
23542:
BREMA ICE MAKERS



1124212 ELETTROVA
LVOLA INGRESSO
ACQUA A 2 VIE /
SOLENOID VALVE 2
WAYS
23502:
BREMA ICE MAKERS



1124278 ELETTROVA
LVOLA INGRESSO
ACQUA A 2 VIE /
SOLENOID VALVE 2
WAYS
23501:
BREMA ICE MAKERS



1124324 Elettrovalvola
ingresso acqua a 2 vie
1,2/1,2 lt /
SOLENOID VALVE 2
WAYS
23646: BREMA ICE
23261: BREMA ICE



1124196 ELETTROVA
LVOLA INGRESSO
ACQUA A 2 VIE /
SOLENOID VALVE 2
WAYS
23157: BREMA ICE
926118: BRICE
ITALIA



1124365 ELETTROVA
LVOLA DUE VIE 230V
90° D.10.5 BASSA
TEMPERATURA /
SOLENOID VALVE 2
WAYS 90° D. 10,5 230V
LOW TEMPERATURE



1124066 ELETTRON.
2 VIE 90° D.10,5 24V /
SOLENOID VALVE 2
WAYS 90° D. 10,5 24V



1124033 ELETTROVA
LVOLA 2 VIE 90° D.
13,5 /
SOLENOID VALVE 2
WAYS 90° D. 13,5



1124154 ELETTROVA
LVOLA 2VIE 90° 230V
D.13,5 ELBI /
SOLENOID VALVE 2
WAYS 90° 230V D.13,5
ELBI



1124036 ELETTROVA
LVOLA 1 VIA 180°
D.10,5 /
SOLENOID VALVE 1
WAY 180° D. 10,5
CEEVI: OMNIWASH
2709000: MARENO
34040022: RANCILIO
902390: SILANOS
4267: MACH
REB240011: COLGED
CF35,CF40: ADLER
D240011: GIGA
DW10703: DIHR
R65110010: LAINOX
26629: HOONVED
0300025: LAMBER
23120021: ELFRAMO
120173: HOONVED
MA2709000:
MARENO
240016: ELETTOBAR
843101: TEIKOS SRL



1124182 ELETTROVA
LVOLA INGRESSO
ACQUA 180° D.10,5 1,2L
/
SOLENOID VALVE 1
WAY 180° D. 10,5 1,2L
CM19865518:
SCOTSMAN ICE SRL
65010560: SCOTSMAN
65010566: SCOTSMAN
65010550: SCOTSMAN
CM19865518:
CASTEL MAC SPA



1124042 VAL.EN. H2O
220-240 1EN.3/4 D10 /
WATER ENTRY
SOLENOID VALVE H2O
220-240 1 WAY 3/4 D. 10
Z1ID003: SCOTSMAN
65010554: SCOTSMAN
CM19865502/0:
CASTEL MAC SPA



1124293 ELETTROVA
LVOLA SINGOLA
DRITTA 220-240V 3/4 /
WATER INLET VALVE
220V-240V 3/4
65010564:
SCOTSMAN ICE SRL



1124337 WATER
INLET VALVE /
WATER INLET VALVE
65010574:
SCOTSMAN ICE SRL



1124321 ELETTROVA
LVOLA SEMPLICE
IDR025 /
SOLENOID VALVE
SIMPLE IDR025
1DR025: **MIGEL S.R.L.**



1124226 ELETTROVA
LVOLA 220V 50-60Hz /
SOLENOID VALVE
220V 50-60Hz
80002DR025: **MACH**
2DR025: **MIGEL S.R.L.**



1124364 ELETTROVA
LVOLA 1 VIA 220V 180°
D. 10,5 BASSA
TEMPERATURA /
SOLENOID VALVE 1
WAY 180° D. 10,5 230V
LOW TEMPERATURE



1124252 SOLENOID /
SOLENOID
65010503:
SCOTSMAN ICE SRL



1124063 ELETTRIV.
1 VIA 180° D.10,5 24V /
SOLENOID VALVE 1
WAY 180° D. 10,5 24V
*: **OMNIWASH SRL**

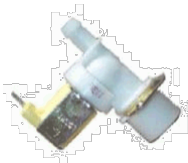

1124200 ELETTROVA
LVOLA 180° 24V DC /
SOLENOID VALVE
180° 24V DC



1124031 ELETTROVA
LVOLA 1 VIA 180°
D.13,5 /
SOLENOID VALVE 1
WAY 180° D. 13,5
DW30001000: **DIHR**
3106180:
WINTERHALTER



1124172 ELETTROVA
LVOLA 1 VIA 180° 230V
D.13,5 ELBI /
SOLENOID VALVE 1
WAY 180° 230V D.13,5
ELBI



1124037 ELETTROVA
LVOLA 1 VIA 180° 24V
d.13,5 /
SOLENOID VALVE 1
WAY 180° 24V

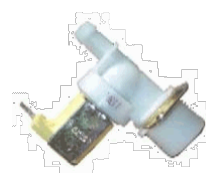

1124168 ELETTROVA
LVOLA DOPPIA 180°
D.10,5 ELBI 230V /
SOLENOID VALVE 2
WAYS 180° D.10,5 ELBI
230V
9041010:
GRUPPO CIMBALI SPA
977092000:
GRUPPO CIMBALI SPA



1124008 ELETTROVA
LVOLA 2 VIE 180°
D.10,5 /
SOLENOID VALVE 2
WAYS 180° D. 10,5
120146: **COMENDA**
843103: **TEIKOS SRL**
*: **MBM- EUROTEC**

SRL
240003: **ELETTROBAR**
34040021: **RANCILIO**
CEEV2: **OMNIWASH**
902400: **SILANOS**
DEV3D: **COLGED**
1573: **MACH**
DW15098: **DIHR-ALI**
D240003: **GIGA**
26631: **HOONVED**
03000056: **LAMBER**
3300500: **LASA SRL**
R65110040-R65115:
LAINOX ALI SPA
23120001: **ELFRAMO**
049230: **ELECTROLUX**
929172: **ELETTROBAR**
425311034: **GICO SPA**



1124084 ELETTROVA
LVOLA DOPPIA X
SIMAG /
DOUBLE SOLENOID
VALVE FOR SIMAG
CM19865530:
SCOTSMAN ICE SRL
819865530:
GRUPPO CIMBALI SPA
CM19865530/0:
CASTEL MAC SPA
19865530: **SIMAG**
SPA



1124213 VALVE /
VALVE

Z1CW030: **SIMAG**

SPA

Z1CW030:

SCOTSMAN ICE SRL



1124207 WATER
SOLENOID VALVE /
WATER SOLENOID
VALVE

65010553:

SCOTSMAN ICE SRL



1124208 VALVE

ASSY /
VALVE ASSY

65010557:

SCOTSMAN ICE SRL



1124114 VALVOLA
ENTRATA ACQUA /
WATER IN VALVE

65010570:

SIMAG SPA

*: **SCOTSMAN ICE**

889125079:

GRUPPO CIMBALI SPA

65010562*:

SCOTSMAN ICE SRL

65010551*:

SCOTSMAN ICE SRL



1124366 ELETTROVA
LVOLA 2 VIE 230V 180°
D.10.5 BASSA
TEMPERATURA /
SOLENOID VALVE 2
WAYS 180° D. 10,5 230V
LOW TEMPERATURE



1124065 ELETTROVA
LVOLA 2 VIE 180°
D.10,5 24V /
SOLENOID VALVE 2
WAYS 180° D. 10,5 24V



1124032 ELETTROVA
LVOLA 2 VIE 180°
D.13,5 /
SOLENOID VALVE 2
WAYS 180° D. 13,5

DW3000101:

DIHR-ALI SPA

3106182:

WINTERHALTER



1124210 ELETTROVA

LVOLA 2 VIE 180°

D.13,5 ELBI /

SOLENOID VALVE 2

WAYS 180° D.13,5 ELBI



1124099 ELETTROVA

LVOLA 3 VIE 90° D.

10,5 /

SOLENOID VALVE 3

WAYS 90° D. 10,5

AL31, AL42, AL36,

AL46, AL16, AL26,

AF61DPS, AF78DPS:

A.T.A. SRL

120179:

COMENDA ALI SPA

26632:

HOONVED - ALI SPA



1124035 ELETTROVA

LVOLA 3 VIE 90° D.13,5

/

SOLENOID VALVE 3

WAYS 90° D. 13,5



1124010 ELETTROVA

LVOLA 3 VIE 180° D.

10,5 /

SOLENOID VALVE 3

WAYS 180° D. 10,5

34040020:

RANCILIO SPA

902410: **SILANOS**

SRL

CEEV3:

OMNIWASH SRL

DEV3T: **COLGED**

1195: **MACH**

18010079:

NUOVA SIMONELLI

SPA

DW15099:

DIHR-ALI SPA

3305000: **LASA SRL**

120175:

COMENDA ALI SPA



1124124 ELETTROVA

LVOLA A 3 VIE 180°

COMENDA /

SOLENOID VALVE 3

WAYS 180° COMENDA

*: **COMENDA ALI SPA**



1124195 ELETTROVA
LVOLA 3 VIE 23144/1 /
SOLENOID VALVE 3
WAYS 23144/1

23144/1:

**BREMA ICE MAKERS
SPA**

23144:

**BREMA ICE MAKERS
SPA**



1124034 ELETTROVA
LVOLA 3 VIE 180°
D.13,5 /
SOLENOID VALVE 3
WAYS 180° D. 13,5



1124214 ELETTRV.2
VIE.APERTA4/CHIUSA2
220/50-60 /
SOLENOID VALVE 2
WAYS 220/50-60

23138:

**BREMA ICE MAKERS
SPA**

N23138: N.T.F. SRL



1124194 VALVOLA
DOPPIA ED90/88 BP 1
LIB. /
SOLENOID VALVE 2
WAYS ED90/88 BP 1
LIB.

RF000690:

EURFRIGOR SRL

*: BRICE ITALIA SRL

*: EURFRIGOR ICE
MAKERS SRL



1124043 VAL.EN. H20
220-240 1EN. 3/4 2U /
WATER ENTRY
SOLENOID VALVE H20
220-240 1WAY IN 3/4
2WAYS OUT

AL31, AL36, AL41,

AL46: A.T.A. SRL

CM19865509/0:

CASTEL MAC SPA

CM19865509:

SCOTSMAN ICE SRL

Z1CW029:

SCOTSMAN ICE SRL



1124301 ELETTROVA
LVOLA 2 VIE 220V
50HZ C/REG. PORT. /
SOLENOID VALVE 2
WAYS STRAIGHT 220V
50HZ

R65110230: LAINOX

ALI SPA

LAR65110230: OLIS

LAR65110230:

LAINOX ALI SPA



1124247 ELETTROVA
LVOLA CUOCIPASTA
MARENO N.T. /
SOLENOID VALVE
MARENO

CR0586050:

SILKO ALI SPA

CR0586050:

MARENO

INDUSTRIE ALI SPA



1124336 ELETTROVA
LVOLA 2 VIE /
SOLENOID VALVE
2WAY



1124098 BOBINA
ELETTRVALVOLA LT
220V /
SOLENOID VALVE
COIL LT 220V

630969:

COMENDA ALI SPA



Ø=9mm, H=30mm

1124367 BOBINA
ELETTRVALVOLA
BASSA TEMPERATURA
220V /
SOLENOID VALVE
COIL FOR COLD 220V



Ø=9mm, H=30mm

1124069 BOBINA
ELETTRVALVOLA
24V AC /
SOLENOID VALVE
COIL 24V AC



Ø=9mm, H=30mm

1124150 BOBINA 24V
AC /
COIL 24V AC



Ø=9mm, H=31mm

1124192 BOBINA 24V
CC /
SOLENOID VALVE
COIL 24V CC



Ø=9mm, H=31mm

1124071 REGOLATO
RE USCITA 0,25L.
ROSSO /
RED DEBIT
REGULATOR 0,25L.
Z1ID002: **SIMAG SPA**



1124176 RIDUTTORE
FLUSSO 0,25 L/MIN
VERDE ELBI /
GREEN DEBIT
REGULATOR
0,25LT/MIN ELBI
64002201:
SCOTSMAN ICE SRL



1124073 REGOLATO
RE USCITA 0,5L.
ARANCIO /
ORANGE DEBIT
REGULATOR 0,5L.
10558: **ADLER S.P.A.**
401200500:
**STAFF ICE SYSTEM
SRL**
4167-3306500:
LASA SRL

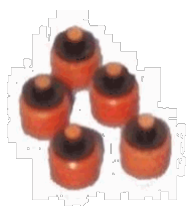

1124201 REGOLATO
RE DI USCITA ELBI 0,5
LT/MIN /
DEBIT REGULATOR
ELBI 0,5 LT/MIN



1124211 REGOLATO
RE DI USCITA 0,8 LT/H
BIANCO /
DEBIT REGULATOR 0,8
LT/H



1124072 REGOLATO
RE USCITA 1,2L.
MARRONE /
BROWN DEBIT
REGULATOR 1,2L.
4012006000:
**STAFF ICE SYSTEM
SRL**
65010520:
SCOTSMAN ICE SRL
*: **MBM- EUROTEC
SRL - DIV. COOKING
SERVICE**



1124237 RIDUTTORE
DI PORTATA ELBI
1,2L/MIN BIANCO /
WHITE DEBIT
REGULATOR ELBI 1,2
L/M



1124137 RIDUTTORE
DI PORTATA 2 LT ELBI
/
DEBIT REGULATOR 2
LT ELBI



1124074 REGOLATO
RE USCITA 2,5L.
GIALLO /
YELLOW DEBIT
REGULATOR 2,5L.

*: **MBM- EUROTEC
SRL - DIV. COOKING
SERVICE**

RF000702:
**EURFRIGOR ICE
MAKERS SRL**
4012008000:
**STAFF ICE SYSTEM
SRL**
65010521:
SCOTSMAN ICE SRL
172833:
**MBM- EUROTEC SRL -
DIV. COOKING
SERVICE**



1124222 RIDUTTORE
DI PORTATA IN
USCITA 2,5L/MIN /
DEBIT REGULATOR
2,5L/MIN



1124075 REGOLATO
RE USCITA 3L. VERDE /
GREEN DEBIT
REGULATOR 3L.

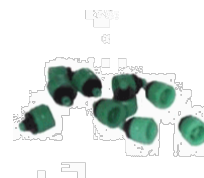

1124236 RIDUTTORE
DI PORTATA ELBI 4,7
L/MIN BIANCO /
WHITE DEBIT
REGULATOR ELBI 4,7
L/M



1124076 REGOLATO
RE USCITA 5L. NERO /
BLACK DEBIT
REGULATOR 5L.

Z1CW022:
SIMAG SPA
650100522:
SCOTSMAN ICE SRL

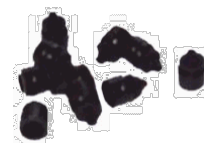

1124209 RIDUTTORE
DI PORTATA IN
USCITA 5,5 LT/MIN /
DEBIT REGULATOR 5,5
LT/MIN



1124126 RIDUTTORE
FLUSSO 1,8LT/MIN /
DEBIT REGULATOR
1,8LT/MIN
64002200:
SCOTSMAN ICE SRL



1124128 CONTROLL
O DI FLUSSO D. 1,5 /
DEBIT REGULATOR D.
1,5
64002202:
SCOTSMAN ICE SRL



1124138 RIDUTTORE
DI PORTATA 2,5LTM
/ DEBIT REGULATOR
2,5LTM
64002203:
SCOTSMAN ICE SRL



1124206 RIDUTTORE
DI PORTATA 5,5L/MIN /
DEBIT REGULATOR
5,5L/MIN



1124318 RIDUTTORE
DI PORTATA IN
INGRESSO ELBI
12LT/MIN /
REDUCING FLOW
INLET ELBI 12LT/MIN



1124255 RIDUTTORE
DI PORTATA IN
INGRESSO 16 LT/MIN /
DEBIT REGULATOR 16
LT/MIN



1124017 EL.VAL. 2
VIE ACQUA 1/4" 220V /
"WATER SOLENOID
VALVE 2 WAYS 1/4" 220V"



1124022 EL.VAL. 2
VIE 1/4" VAP/ACQUA
24 /
"STEAM/WATER
SOLENOID VALVE 2
WAYS 1/4" 24"



1124024 EL.VAL. 1/4"
VAP/ACQUA 220V /
"STEAM/WATER
SOLENOID VALVE
1/4" 220V"



1124018 EL.VAL. 2
VIE 3/8" ACQUA 220V /
"WATER SOLENOID
VALVE 2 WAYS 3/8" 220V"



1124019 EL.VAL. 1/2"
ACQUA 220V 50HZ /
"WATER SOLENOID
VALVE 1/2" 220V
50HZ"

120174:
COMENDA ALI SPA
120174:
HOONVED - ALI SPA



1124041 ELETTR. V.
1/2" ACQUA 220V BG /
"WATER SOLENOID
VALVE 1/2" 220V BG"



1124085 ELETTR. V.
LVOLA L140 FF1/2"
230V /
"SOLENOID VALVE
L140 FF1/2" 230V"

23140006*:
ELFRAMO SPA



1124023 EL.VAL. 2
VIE 1/2" VAP/ACQUA
24V /
"STEAM/WATER
SOLENOID VALVE 2
WAYS 1/2" 24V"

23140004:
ELFRAMO SPA



1124026 EL.VAL. 1/2"
VAP/ACQUA 220V /
"STEAM/WATER
SOLENOID VALVE
1/2" 220V"



1124108 EL.VAL. 2
VIE 1/2" VAP/ACQUA
220V APERTA /
"STEAM/WATER
SOLENOID VALVE 2
WAYS 1/2" 220V"



1124025 EL.VAL. 2
VIE 1/2" VAP/ACQUA
220V /
"STEAM/WATER
SOLENOID VALVE 2
WAYS 1/2" 220V"
23140006
: **ELFRAMO SPA**



1124020 EL.VAL. 3/4"
ACQUA 220V 50HZ /
"WATER SOLENOID
VALVE 3/4" 220V
50HZ"
120158:
COMENDA ALI SPA



1124341 "ELETTRO
VALVOLA X ACQUA
NC 3/4"
PRESS.DIFF.0,15/13BAR
" 24V AC /
SOLENOID VALVE FOR
WATER NC 3/4" ".0,15 /
13BAR" 24V AC



1124021 EL.VAL.
1"ACQUA/GAS 220V 50-
60 /
"WATER/GAS
SOLENOID VALVE 1"
220V 50-60"



1124027 EL.VAL. 2
VIE 1/4" GAS 220V /
"GAS SOLENOID
VALVE 2 WAYS 1/4"
220V"



1124028 EL.VAL. 2
VIE 1/2" GAS 220V /
"GAS SOLENOID
VALVE 2 WAYS 1/2"
220V"



1124029 EL.VAL. 2
VIE 3/4" GAS 220V /
"GAS SOLENOID
VALVE 2 WAYS 3/4"
220V"



1124118 ELETTR. V.
VAPORE 24V 1/2" /
"STEAM SOLENOID
VALVE 24V 1/2"
120165:
COMENDA ALI SPA



1124121 ELETTROVA
LVOLA VAPORE
L145R1Z734AA 1/2" 24V
/
"STEAM SOLENOID
VALVE L145R1Z734AA
1/2" 24V"
120161:
COMENDA ALI SPA



1124254 ELETTROVA
LVOLA
COMPL.LAVASTOVIGL
IE /
SOLENOID VALVE
COMPL.
090912: FABAR SRL



1124312 ELETTROVA
LVOLA SCARICO ARIA
LINEA 46 /
DRAIN VALVE FOR
AIR LINE 46



1124316 ELETTROVA
LVOLA L140 Z610A
G1/2F 24V /
SOLENOID VALVE
L140 24V Z610A G1/2F
120125:
COMENDA ALI SPA



1124307 "ELETTR. V.
ALVOLA
INDUSTR.3/4" /
"INDUSTRIAL VALVE
3/4" "
27132:
HOONVED - ALI SPA



1124049 ELETTR. V.
VAPORE 1"1/4 180° C /
"STEAM SOLENOID
VALVE 1"1/4 180°C"



1124055 BOBINA X
ELETTRVALVOLA
20/E 220V 50Hz /
SOLENOID VALVE
COIL 20/E

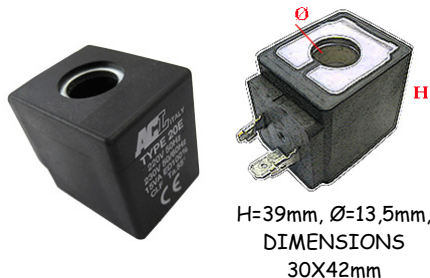

H=39mm, Ø=13,5mm,
DIMENSIONS
30X42mm

1124059 BOBINA X
ELETTRVALVOLA
22/E 220V 50Hz /
SOLENOID VALVE
COIL 22/E

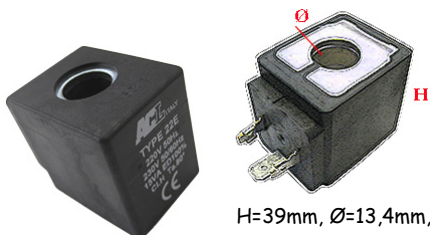

H=39mm, Ø=13,4mm,
DIMENSIONS
30X42mm

1124056 BOBINA X
ELETTRVALVOLA
30/E 230V 50-60Hz /
SOLENOID VALVE
COIL 30/E

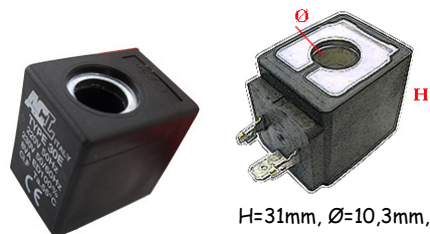

H=31mm, Ø=10,3mm,
DIMENSIONS
22X27mm

1124060 BOBINA X
ELETTRVALVOLA
32/E /
SOLENOID VALVE
COIL 32/E



1124061 BOBINA X
ELETTRVALVOLA
40/E 220V 50Hz /
SOLENOID VALVE
COIL 40/E

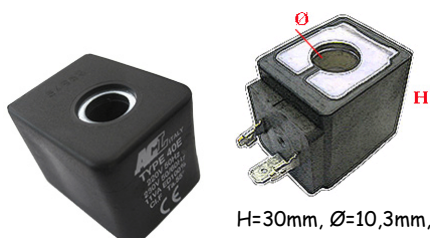

H=30mm, Ø=10,3mm,
DIMENSIONS
30X38mm

1124039 BOBINA
ELETTRVALVOLA
20/B 24V 50HZ /
SOLENOID VALVE
COIL 24V 50HZ

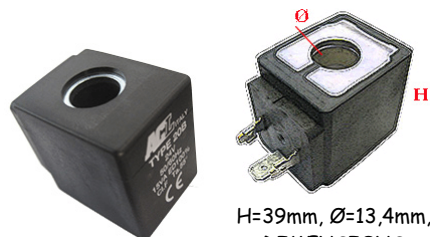

H=39mm, Ø=13,4mm,
DIMENSIONS
30X42mm

1124058 BOBINA X
ELETTRVALVOLA
22/B 24V 50-60Hz /
SOLENOID VALVE
COIL 22/B

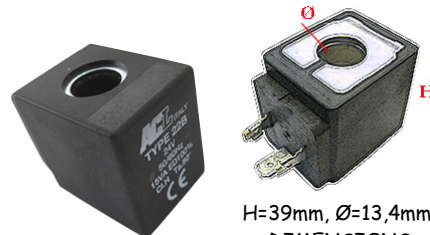

H=39mm, Ø=13,4mm,
DIMENSIONS
30X42mm

1124193 BOBINA 24V
30B /
SOLENOID VALVE
COIL 24V 30B



1124218 BOBINA
TIPO 30/B 24V AC
(ALTERNATA) 50-60Hz
/
SOLENOID VALVE
COIL 30/E 24V DC

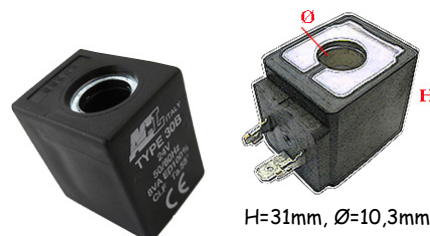

H=31mm, Ø=10,3mm,
DIMENSIONS
22X27mm

1124317 BOBINA 32B
24V AC 50-60Hz /
32B 24V AC COIL

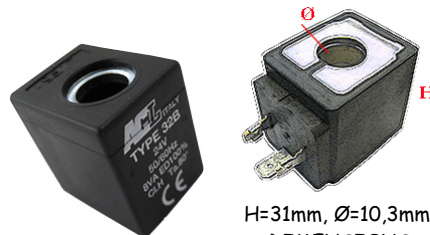

H=31mm, Ø=10,3mm,
DIMENSIONS
22X27mm

1124057 BOBINA X
ELETTRVALVOLA
221 24V= 10W /
SOLENOID VALVE
COIL 221

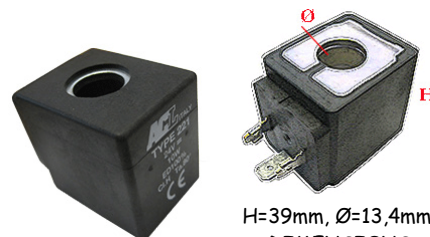

H=39mm, Ø=13,4mm,
DIMENSIONS
30X42mm

1124271 BOBINA X
EV 301 24V= DC 6,5W /
SOLENOID VALVE
COIL 24V DC

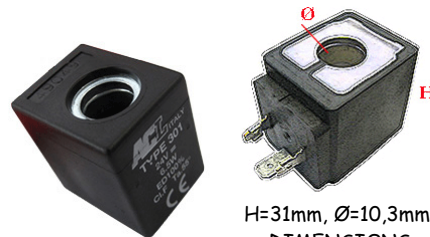

H=31mm, Ø=10,3mm,
DIMENSIONS
22X27mm

1124087 BOBINA
V.48/50-60 E2A NYLON
20/C /
COIL V48/50-60 E2A
NYLON

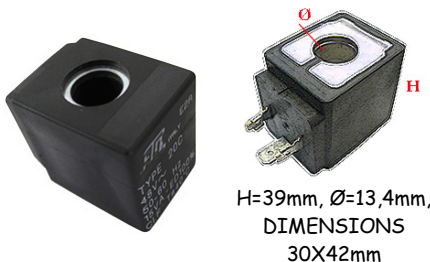

H=39mm, Ø=13,4mm,
DIMENSIONS
30X42mm

1124062 BOBINA X
ELETTROVALVOLA
52/G 380V 50-60Hz /
SOLENOID VALVE
COIL 52/G

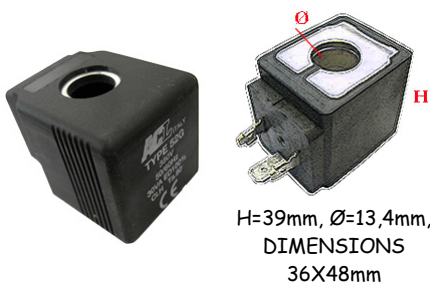

H=39mm, Ø=13,4mm,
DIMENSIONS
36X48mm

1124038 BOBINA
EL.VAL. 380V 50HZ /
SOLENOID VALVE
COIL 380V 50HZ



1124080 CONNETTO
RE RETTANG. X SERIE
30 /
RECTANGULAR
CONNECTOR FOR SET
30

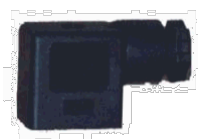

BOBINA=1124093

1124081 CONNETTO
RE QUADRATO X
SERIE 30 /
SQUARE CONNECTOR
FOR SET 30

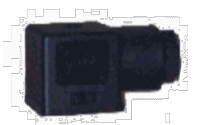

1134090 MOTORIDU
TTORE COMPLETO
ARC /
MOTO REDUCER ARC
5901: A.T.A. SRL



1134138 RIDUTTORE
AVANZAMENTO
R=1.80 Limit. x
MACCHINE TRAINO /
FORWARDING GEAR R
= 1.80 Limit. x
MACHINES TOWING
3453: KRUPPS S.R.L.
3453:
ARISTARCO KASTEL



SPA

1134137 RIDUTTORE
MVF-49A 1/36 /
GEAR MVF-49 A 1/36
927151:
ELETTROBAR
DIVISIONE DELLA
EUROTEC SRL



1134082 RIDUTTORE
MVF-49A 1/60 /
MOTOREDCER MVF -
49A 1/60
*: MBM- EUROTEC
SRL - DIV. COOKING
SERVICE
927102:
ELETTROBAR
DIVISIONE DELLA
EUROTEC SRL



1134131 RIDUTTORE
VF49P P63B5B3 RAPP 1:
80 /
GEAR VF49P P63B5B3
RAPP 1: 80
20130008:
ELFRAMO SPA



1134117 MOTORIDU
TTORE 255/268 LOGIX
CON CAVI /
GEAR MOTOR 255/268
LOGIX WITH CABLE



1134042 CALOTTA
ABS+ VITI /
COVER ABS

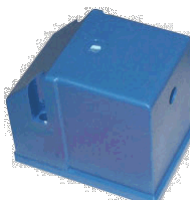

1134074 FRIZIONE
ET COMPLETA /
COMPLETE CLUTCH
00045520:
ELFRAMO SPA



3108089 MANOPOLA
30/90° /
HANDLE 30/90°
903982: SILANOS
SRL

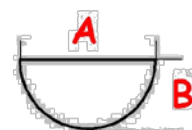

A= 6mm, B= 5mm

3108091 MANOPOLA
TERMOSTATO 40/210° /
THERMOSTAT
HANDLE 40/210°

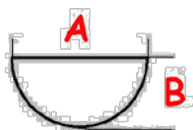

A= 6mm, B= 5mm

3108090 MANOPOLA
TERMOSTATO 50/300° /
THERMOSTAT
HANDLE 50/300°

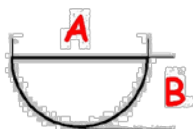

A= 6mm, B= 5mm

3108076 MANOPOLA
RUBINETTO GAS D.
6X5 /
GAS COCK HANDLE D.
6X5
30654700:
BERTO'S SPA

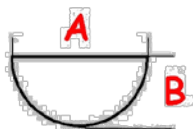

A= 6mm, B= 5mm

3108009 MANOPOLA
RUBINETTO GAS D. 8 /
GAS COCK WHEEL D.8
31875900:
BERTO'S SPA
22650900:
BERTO'S SPA

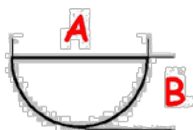

A= 8mm, B=6mm

3108008 MANOPOLA
RUBINETTO GAS D. 10/
GAS COCK WHEEL
D.10

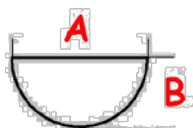

A= 10mm, B= 8mm

3108280 MANOPOLA
SP4-C4ELETTORI /
SWITCH KNOB
7915: A.T.A. SRL

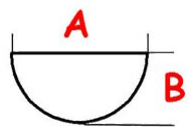

A= 5 mm, B= 5 mm

3108251 MANOPOLA
BIANCA /
WHITE KNOB
5813: A.T.A. SRL



3108297 MANOPOLA
GRIGIA
TAMPOGRAFATA /
GREY KNOB
6826: A.T.A. SRL



PERNO QUADRO /
SQUARED PIN
A= 5 mm , B= 5 mm

3108053 MANOPOLA
BICOLORE COMENDA /
CONTROL KNOB TWO
COLOURS B-BT-F
B, BT, F:
COMENDA ALI SPA



PERNO QUADRO /
SQUARED PIN
A= 5 mm , B= 5 mm

3108220 MANOPOLA
CON INDICE
GR.CHIARO /
KNOB FOR BC-BR-C95-
C155
450323:
COMENDA ALI SPA



PERNO QUADRO /
SQUARED PIN
A= 5 mm , B= 5 mm

3108164 MANOPOLA
NERA B22/23 /
BLACK KNOB B22/23
180111:
COMENDA ALI SPA
180111:
HOONVED - ALI SPA

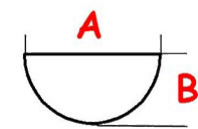

A= 6,5 mm, B= 4 mm

3108521 MANOPOLA
BLU PER ACS /
BLUE KNOB FOR ACS
180152:
COMENDA ALI SPA

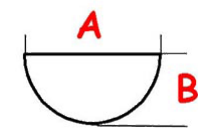

A= 6,5 mm, B= 4 mm

3108117 MANOPOLA
NERA QUAD. N/S /
SQUARED BLACK
KNOB
180120:
COMENDA ALI SPA



PERNO QUADRO /
SQUARED PIN
A= 6 mm, B= 6 mm

3108427 MANIGLIA
PER SEZIONATORE /
ADJUSTING KNOB
450330:
COMENDA ALI SPA



3108024 MANOPOLA
ZANUSSI 048340 /
KNOB ZANUSSI 048340
048340:
ELECTROLUX
PROFESSIONAL
S.P.A.

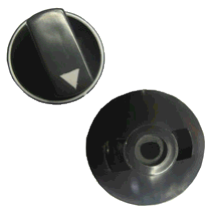

3108578 "MANOPOL
A CON ADATTATORE;
DIA.6; KIT" /
KNOB WITH ADAPTER;
DIA.6; KIT"
0C6670EX:
ELECTROLUX
PROFESSIONAL
S.P.A.
0C8700:
ELECTROLUX
PROFESSIONAL
S.P.A.

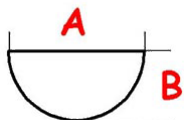
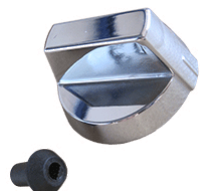

ADATTATORE
A= 10mm, B= 8mm,
A= 6mm, B=5mm

3108504 GRUPPO
MANOPOLA INTERR.
22 /
GROUP KNOB SWITCH
22
999106:
ELETTROBAR
DIVISIONE DELLA
EUROTEC SRL



3108310 MANOPOLA
THERMOSTATO /
THERMOSTAT KNOB
164649:
ELETTROBAR
DIVISIONE DELLA
EUROTEC SRL
*: MBM- EUROTEC
SRL - DIV. COOKING
SERVICE
*: MBM- EUROTEC
SRL - DIV. COOKING
SERVICE
161796:
ELETTROBAR
DIVISIONE DELLA
EUROTEC SRL



3108282 MANOPOLA
THERMOSTATO DX -
MARRONE /
RIGHT THERMOSTAT
KNOB
26669+25828:
HOONVED - ALI SPA
25098EX:
HOONVED - ALI SPA



3108266 MANOPOLA
NERA (INDICE SERIGR.
-DA C.L.) /
BLACK KNOB
6446600: LASA SRL



3108194 MANOPOLA
TIMER ELTTROBAR
COMPLETA /
COMPLETE TIMER
KNOB ELETTROBAR



3108195 MANOPOLA
TIMER ELLETTROBAR
/
TIMER KNOB
ELETTROBAR
447089:
ELETTROBAR
DIVISIONE DELLA
EUROTEC SRL

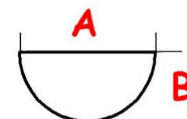

A= 7 mm, B= 6 mm

3108196 PULSANTE
START /
START PUSH-BUTTON
226051:
ELETTROBAR
DIVISIONE DELLA
EUROTEC SRL



3108060 MANOPOLA
TIMER REGOLABILE /
ADJUSTABLE TIMER
KNOB
25095:
HOONVED - ALI SPA



3108081 MANOPOLA
FISSAGGIO LAVAGGIO
NERA /
CAP
447030:
ELETTROBAR
DIVISIONE DELLA
EUROTEC SRL
447128:
ELETTROBAR
DIVISIONE DELLA
EUROTEC SRL

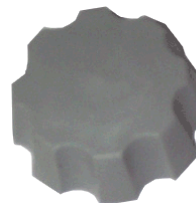

3108378 MANOPOLA
FISSAGGIO FILTRO
FIL. M8 /
KNOB M8
3751:
UNIVER-BAR SRL



3108596 MANIGLIA
FILTRO VASCA 180843 /
HANDLE FILTER TANK
180843
170827:
COMENDA ALI SPA



H=33mm, L=225mm

3108042 MANIGLIA
CHIUSA NERA ABS /
BLACK CLOSED
HANDLE ABS
AM010PC:
OMNIWASH SRL -
SOCIETA' A SOCIO
UNICO



3108358 MANIGLIA
CH. GRIGIO RAL 7011
OVALE COMP /
COMPLETE HANDLE
GREY RAL 7011
AM010MD25GR:
OMNIWASH SRL -
SOCIETA' A SOCIO
UNICO



frame= 3108409

3108398 MANIGLIA
CH. OVALE COMP /
HANDLE RAIL BLUE
AM010MD25:
OMNIWASH SRL -
SOCIETA' A SOCIO
UNICO



3108409 CORNICE
SENZA MANIGLIA
OVALE GRIGIO RAL
7011 UNI /
OVAL FRAME
WITHOUT HANDLE
GREY
AM010CD25GR:
OMNIWASH SRL -
SOCIETA' A SOCIO
UNICO



knob=3108358

4120116 CORNICE
S/MANIGLIA OVALE
STAMPO 142 UNI /
OVAL KNOB FRAME
AM010CD25:
OMNIWASH SRL -
SOCIETA' A SOCIO
UNICO



3108566 MANIGLIA
APERTA ABS NERO /
HANDLE OPEN ABS
BLACK
AM010PA:
OMNIWASH SRL -
SOCIETA' A SOCIO
UNICO



3108588 MANIGLIA
CHIUSA ABS BLUE /
HANDLE CLOSED -
ABS BLUE
AM010GB:
OMNIWASH SRL -
SOCIETA' A SOCIO
UNICO



Interasse=120mm,
Foro fissaggio=5mm,
Lunghezza=250mm

3108474 DOOR
HANDLE /
DOOR HANDLE
T00202:
SCOTSMAN ICE SRL



3108476 MANOPOLA
SPINGICARR. AD "U"
int. fori 115 /
"U" SHAPED HANDLE
INT. 115



Interasse=115mm

3108118 MANIGLIA
PORTA B11-12 440-2 /
DOOR HANDLE B11-12
440-2
170808:
COMENDA ALI SPA
170809:
COMENDA ALI SPA



3108287 MANIGLIA
INOX TEKNO 6.0 /
INOX HANDLE TEKNO
6.0
560955:
DIHR-ALI SPA



LENGTH= 550 mm

3108517 MANIGLIA
IN PLASTICA /
HANDLE PLASTIC
DW540502:
DIHR-ALI SPA



3108535 MANIGLIA
IN PLASTICA /
HANDLE PLASTIC
DW560550:
DIHR-ALI SPA



3108449 MANIGLIA
LAVASTOVIGLIE ELF
GRIGIA /
HANDLE ELFRAMO
GREY
0010610:
ELFRAMO SPA

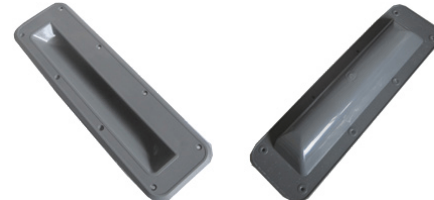

3108373 MANIGLIA
PORTA /
DOOR HANDLE
F5E:
GRUPPO CIMBALI SPA
984527000:
GRUPPO CIMBALI SPA



3108349 MANIGLIA
PICCOLA FAEMA /
HANDLE FAEMA

9031156:

GRUPPO CIMBALI
SPA

984526000:

GRUPPO CIMBALI SPA

F68: FAEMA



3108565 ASSIEME
MANIGLIA CIMBALI /
ASSEMBLY HANDLE
CIMBALI

984527000:

GRUPPO CIMBALI SPA



Interasse=187mm,
L=391mm

3108599 MANIGLIA
SAP 48 /
HANDLE SAP 48

984530000:

GRUPPO CIMBALI SPA



L=480mm

3108332 MANIGLIA
X PORT. STS/APS/C 60 /
DOOR HANDLE

STS/APS/C 60

18829:

HOONVED - ALI SPA



3108606 MANIGLION
E ED 600/700/900/90 /
HANDLE ED
600/700/900/90

18104:

HOONVED - ALI SPA



Interasse= 465mm,
L=485mm

3108501 MANIGLIA
A.NSA47 INOX 304
DIAMOND /
HANDLE STAINLESS
STEEL DIAMOND 304

168204:

MBM- EUROTEC SRL
- DIV. COOKING
SERVICE

PACU800122EX:

MBM- EUROTEC SRL -
DIV. COOKING
SERVICE



3108274 MANIGLIA
F.G4SF SMALT.NERA /
BLACK HANDLE
F.G4SF

PACU800131ex:

MBM- EUROTEC SRL -
DIV. COOKING
SERVICE

168205:

MBM- EUROTEC SRL -
DIV. COOKING
SERVICE



3108275 MANIGLIA
F.G6SF2 SMALT.NERA /
BLACK HANDLE
F.G6SF2

PACU800060:

MBM- EUROTEC SRL -
DIV. COOKING
SERVICE



3108283 MANIGLIA
PLASTICA N600/V45 /
HANDLE N600/V45

903932: SILANOS

SRL



3108339 MANIGLIA
PLASTICA L.510 /
HANDLE L.510

903933: SILANOS

SRL



3108284 PROFILO
MANIGLIA N600
NEUTRO BLU /
HANDLE OUTLINE
N600

901658: SILANOS

SRL



3108014 MANIGLION
E PORTELLO 1300 /
DOOR HANDLE 1300

903900: SILANOS

SRL

903901: SILANOS

SRL

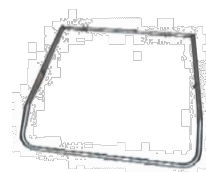

3108495 Maniglione
Compact /
HANDLE CAPOTE FOR
UNIVERBAR COMPACT

4768:

UNIVER-BAR SRL



3108345 MANIGLIA
LUNGH.412 LVP1001 /
HANDLE ROD TUBE
L412 LPV1001
S: AC; ACR; N; NE; G:
COMENDA ALI SPA



=3108346

3108346 SUPP.MANI
GLIA SE/1 NE NERO /
HANDLE SUPPORT
SE/1 BLACK
S: AC; ACR; N; NE; G:
COMENDA ALI SPA



=3108345

3108344 MANIGLIA
LP60 /
HANDLE LP60
00093288:
ELFRAMO SPA
LP130: ELFRAMO SPA
00093236:
ELFRAMO SPA



3108248 TERMINALE
MANIGLIA F.G4SF7
RAG.TURCH. /
END HANDLE F.G4SF7
RAG.TURCH
RTC900413:
MBM- EUROTEC SRL -
DIV. COOKING
SERVICE
RTC700291:
MBM- EUROTEC SRL -
DIV. COOKING
SERVICE



3108188 MANOPOLA
FABAR /
HANDLE FABAR
02017: FABAR SRL

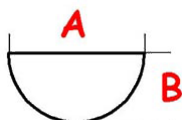

A=12mm, B=12mm

3108443 MANIGLIA
SPORTELLLO /
DOOR HANDLE
02017B: FABAR SRL



3108598 KNOB,
LOCKING TOP COVER /
KNOB, LOCKING TOP
COVER
915167: HOBART
GmbH

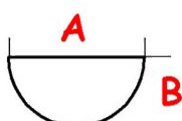

A=6mm, B=5mm

3108360 MANOPOLA
FISSAGGIO FILTRO
FIL. M5 /
FILTER FIXING KNOB
M5
4159:
UNIVER-BAR SRL



3108341 MANOPOLA
Ø 40 MM. PASSO M6 /
KNOB Ø 40 MM. M6



3112471 MULINELL
O DS 400 ASSIEME /
WASH ARM
ASSEMBLY DS 400
12169: ADLER S.P.A.



DIMENSIONS
380X380mm

3112451 ASS.
CROCERA INOX
LAVAB. COMPL.
PROJECT /
WASH ARM CENTRE
PROJECT
4724:
ARISTARCO SPA



DIMENSIONS
360X360mm,
JETS= 3101137

3112114 MULINELL
O LAVAGGIO G65-
G115 /
WASH ARM
COMPLETE G65-G115
G115-G65-G75:
COMENDA ALI SPA



X= 3102112, Y=3102051,
DIMENSIONS
540X540mm,

3112109 MULINELL
O INF. B DUMPER
COMENDA /
INFERIOR FAN B
DUMPER COMENDA
420545:
COMENDA ALI SPA

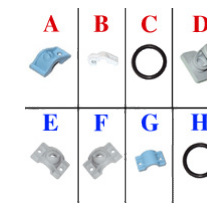
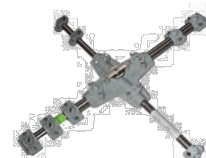

A= 3101022, B=3101023,
C=2101308, D=4115425,
E=3101087, F=3101088,
G=3102011, H= 2101314,
DIMENSIONS
410X410mm

3112183 MULINELL
O LAV.SUP.B15-19 /
WASH ARM B15-19
420538:
COMENDA ALI SPA

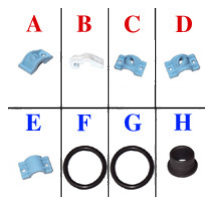
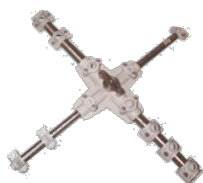

A= 3101022, B=3101023,
C=3102009, D=3102010,
E=3102011, F=2101308,
G=2101314, H=2107050,
DIMENSIONS
410X410mm

3112164 MULINELL
O PL.MONTATO F20-
BC H53mm /
FAN F20-BC
420531:
HOONVED - ALI SPA
420531:
COMENDA ALI SPA

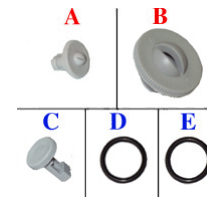
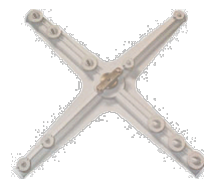

A= 3101027, B=3101119,
C=4115218, D=2101187,
E= 2101378,
DIMENSIONS
405X405mm

3112110 MULINELL
O SUP.B DUMOER
COMENDA /
UPPER FAN B
DUMOER COMENDA
H420546:
HOONVED - ALI SPA
420546:
COMENDA ALI SPA

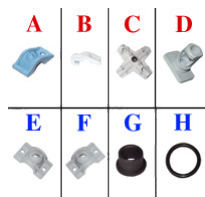
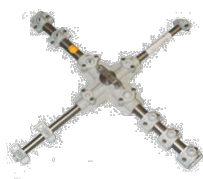

A= 3101022, B=3101023,
C= 3112118, D=4115425,
E= 3101087, F=3101088,
G= 2107050, H=2101314,
DIMENSIONS
410X410mm

3112108 MULINELL
O LAVAGGIO
SUP.LBC-BHC
COMENDA H 38mm /
UPPER WASHING FAN
LBC-BHC COMENDA
ex420533:
COMENDA ALI SPA
420551:
COMENDA ALI SPA
420551:
HOONVED - ALI SPA

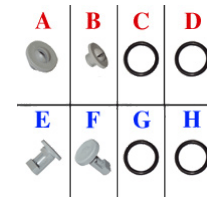

A= 3101027, B=3101119,
C= 2101132, D=2101187,
E= 4115714, F=4115218,
G= 2101317, H=2101378,
DIMENSIONS
405X405mm

3112119 MULINELL
O F90M/LF400-WASH
ARM /
WASH ARM
F90M/LF400
420522:
COMENDA ALI SPA

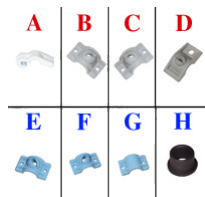

A= 3101023, B=3101087,
C=3101088, D=3101089,
E=3102009, F=3102010,
G= 3102011, H=2107050,
DIMENSIONS
570X570mm

3112196 MULINELL
O
PLAST."LF/LP/F45" c/* /
PLASTIC FAN FOR
LF/LP/F45
420526:
HOONVED - ALI SPA
LF/LP/F45:
COMENDA ALI SPA

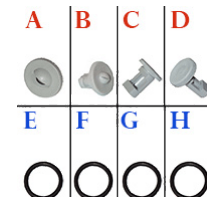

A=3102071, B=3101027,
C= 4115714, D=4115218,
E=2101187, F= 2101132,
G= 2101317, H=2101378,
DIMENSIONS
505X505mm

3112153 MULINELL
O LAVAGGIO /
WASH FAN LC 380-
C140 ECOTEC
C140-LC380:
COMENDA ALI SPA

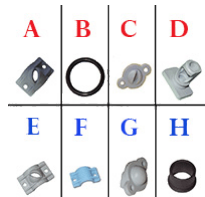
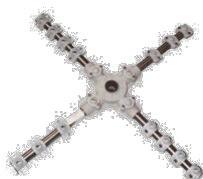

A=3102068, B=2101314,
C= 3101113, D=4115425,
E= 3101117, F= 3102011,
G= 3101118, H=2107062

3112158 MULINELL
O LAVAGGIO C1300-
C155 /
WASH ARM C1300-
C155
420535:
COMENDA ALI SPA

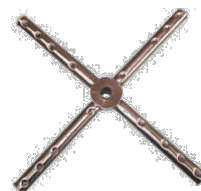

DIMENSIONS
495X495mm

3112160 MULINELL
O LAVAGG.F2 CORPO
OT /
WASHING FAN F2
BODY OT
420510:
COMENDA ALI SPA

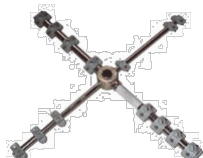

DIMENSIONS
510X510mm

3112144 GRUPPO
LAV+RISC. G450/94 /
WASH ARM
COMPLETE G450/94
DW26957:
DIHR-ALI SPA

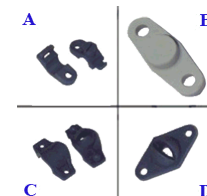
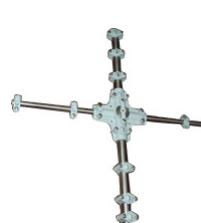

A= 3101094, =3101096,
C= 3101102, D=3101104,

3112130 GRUPPO
LAVAGGIO
RISCIACQUO D.28
DIHR /
WASH/RINSE ROD D.28
DIHR

DW75910EX:
DIHR-ALI SPA
DW75913:
DIHR-ALI SPA
DW15958:
DIHR-ALI SPA
DW15956:
DIHR-ALI SPA

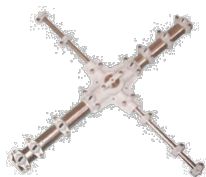

A= 3101094, B=3101096,
C= 3101102, D=3101104,
DIMENSIONS
485X485mm

3112142 GRUPPO
LAV+RISC.INF 97/370
LS P646 /
WASH/RINSE ROD
97/370 LS P646

DW18996:
DIHR-ALI SPA

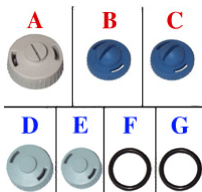

A=3101082, B= 3101098,
C=3101140, D= 3101141,
E= 3101152, F=2101368,
G= 2101314,
DIMENSIONS
370X370mm

3112131 GRUPPO
LAVAGGIO
RISCIACQUO
INFERIORE 97/350
DIHR /
LOWER WASH/RINSE
ROD 97/350 DIHR

EXDW10998:
DIHR-ALI SPA
DW10999:
DIHR-ALI SPA
DW10990EX:
DIHR-ALI SPA

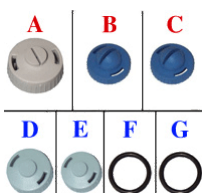
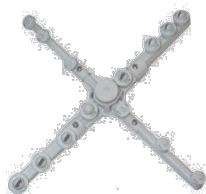

A=3101082, B=3101098,
C=3101099, D= 3101100,
E=3101152, F= 2101123,
G=2101314,
DIMENSIONS
370X370mm

3112140 GRUPPO
LAV.+RISC. C40 LSE /
WASH/RINSE ROD C40
LSE

DW400909:
DIHR-ALI SPA
DW540995ex:
DIHR-ALI SPA
DW540996:
DIHR-ALI SPA

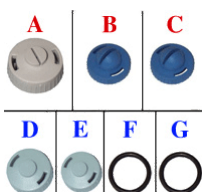

A= 3101082, B=3101098,
C=3101099, D= 3101100,
E=3101152, F= 2101123,
G=2101314,
DIMENSIONS
400X400mm

3112132 GRUPPO
LAVAGGIO/RISCIACQ
UO INF. 97 400 DIHR /
LOWER WASH/RINSE
ROD 97/400 DIHR

gs40: DIHR-ALI SPA

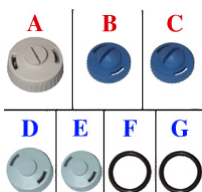
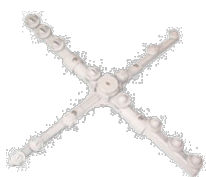

A= 3101082, B=3101098,
C=3101099, D= 3101100,

E=3101152, F= 2101123,
G=2101314,
DIMENSIONS
405X405mm

3112564 GRUPPO
LAVAGGIO/RISCIACQ
UO D.490MM /
GROUP WASH / RINSE
D.490MM
DW500750:
DIHR-ALI SPA

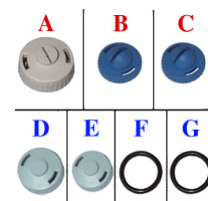

A= 3101082, B=3101098,
C=3101099, D= 3101100,
E=3101152, F= 2101123,
G= 2101314,
DIMENSIONS
485X485mm

3112599 BRACCIO
LAVAGGIO /
WASH ARM

070349:
ELECTROLUX
PROFESSIONAL
S.P.A.
12169: ADLER S.P.A.



3112084 GRUPPO
LAVAGGIO
RISCIACQUO 21/31 /
WASH ARM
COMPLETE 21/31

990008:
ELETTOBAR
DIVISIONE DELLA
EUROTEC SRL



X= 3101067, Y=3101068,
W=3102044, Z=3102033

3112344 GRUPPO DI
LAVAGGIO/RISCIACQ
UO INFERIORE /
INFERIOR
WASH/RINSE GROUP

E45:
ELETTOBAR
DIVISIONE DELLA
EUROTEC SRL

*:
MBM- EUROTEC SRL -
DIV. COOKING
SERVICE

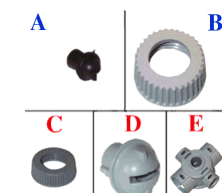
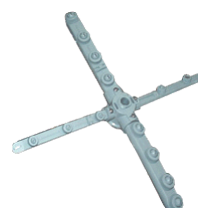

A= 3101067, B=3101068,
C=3102033, D=3102044,
E=3112046

3112303 GRUPPO
LAVAGGIO RISC.E35
NM /
COMPLETE WASH
ARM E35 NM

*: MBM- EUROTEC
SRL - DIV. COOKING
SERVICE
990103: ELETTOBAR



X= 3101067, Y=3101068,
W=3102044, Z=3102032
DIMENSIONS
355X355mm

3112290 GRUPPO
LAVAGGIO RISC.E40
NM /
WASH/RINSE ROD E40
NM

*: **MBM- EUROTEC
SRL - DIV. COOKING
SERVICE**
990104: ELETTROBAR

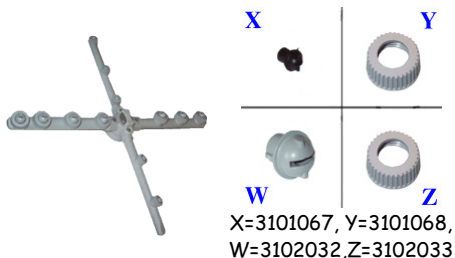

X=3101067, Y=3101068,
W=3102032, Z=3102033

3112512 GRUPPO
LAVAGGIO RISC. E.40 /
WASH-RINSE ROD E.40

**990094:
ELETTROBAR
DIVISIONE DELLA
EUROTEC SRL**

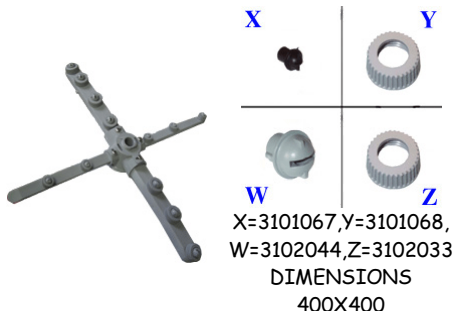

X=3101067, Y=3101068,
W=3102044, Z=3102033
**DIMENSIONS
400X400**

3112357 GRUPPO DI
LAVAGGIO E DI
RISCIACQUO
SUPERIORE /
UPPER WASH/RINSE
GROUP

**990069ex:
ELETTROBAR
DIVISIONE DELLA
EUROTEC SRL
NIAGARA51:
ELETTROBAR
DIVISIONE DELLA
EUROTEC SRL**

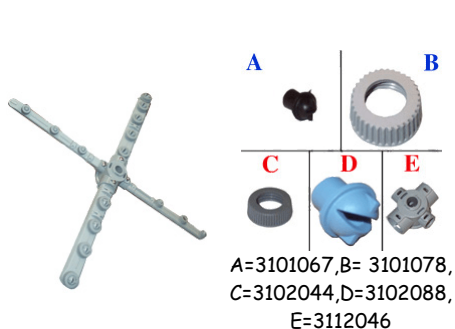

A=3101067, B= 3101078,
C=3102044, D=3102088,
E=3112046

3112534 GRUPPO
LAV.RISC.SUPER.
463/503 /
UPPER WASH-RINSE
ROD 463/503

**990074EX:
ELETTROBAR
DIVISIONE DELLA
EUROTEC SRL**



**DIMENSIONS
405X405mm**

3112528 GRUPPO
LAV./RISC.INFERIORE
503 /
LOWER WASH-RINSE
ROD 503

**990075:
ELETTROBAR
DIVISIONE DELLA
EUROTEC SRL**

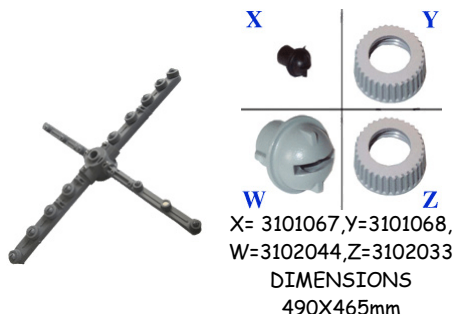

X= 3101067, Y=3101068,
W=3102044, Z=3102033
**DIMENSIONS
490X465mm**

3112640 MULINELL
O LAVAGGIO /
RISCIACQUO C600-
PS60 495mm /
WHEEL WASHING /
RINSE C600-PS60
495MM

79040:

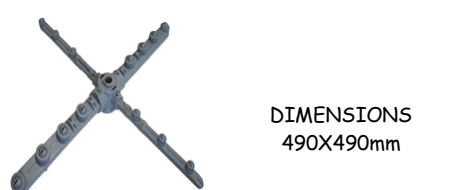

**DIMENSIONS
490X490mm**

**ELETTROBAR
DIVISIONE DELLA
EUROTEC SRL**

3112428 GRUPPO DI
LAVAGGIO/RISCIACQ
UO INFERIORE /
WASH ARM CENTRE
WITH 2 WASH ARMS/2
RINSE ARMS

**990105:
ELETTROBAR
DIVISIONE DELLA
EUROTEC SRL**

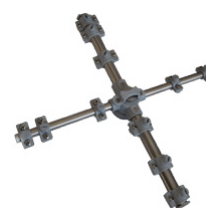

**DIMENSIONS
355X355mm**

3112041 GIRANTE
LAVAGGIO MRS400
ELFRAMO /
WASH ROD MRS
ELFRAMO

**00005200:
ELFRAMO SPA**



3112278 GRUPPO
LAVAGGIO INF. MR
600 RICAMBI /
WASH ARM 522
LOWER

**00005220:
ELFRAMO SPA**



3112441 BRACCIO
LAV. RISC. IN
PLASTICA X
Q50FE/CME /
WASH/RINSE ARM X
Q50FE/CME

07098P: FABAR SRL



3112598 BRACCIO
LAVAGGIO
RISCIACQUO IN
PLASTICA X Q40SEM /
ARM WASH RINSE
PLASTIC X Q40SEM

06087P: FABAR SRL



3112535 GIRANTE
LAVAGGIO/RISCIACQ
UO COMPLETA /
WASH AND RINSE
ARM

**207851K:
KRUPPS S.R.L.**



**DIMENSIONS
325X325mm**

3112454 GIRANTE
LAVAG. E RISC.
COMPLETA DI
BUSSOLE 40X40 /

**208851K:
KRUPPS S.R.L.
208850:
KRUPPS S.R.L.**



**DIMENSIONS
390X385mm, = 3101165**

3112629 GIRANTE
LAVAGGIO E
RISCIACQUO
COMPLETA 450 mm /
WASH/RINSE ARM
ASSEMBLY 450 mm
45085K:
KRUPPS S.R.L.



DIMENSIONS
443X447 mm

3112531 GIRANTE
LAVAGGIO E
RISCIACQUO
COMPLETA /
COMPLETE WASH-
RINSE ARM
600851K:
KRUPPS S.R.L.



DIMENSIONS
500X480mm

3112170 GIRANTE
Q MOD. 1 CS/CL JOLLY
COMP. /
ROD CQ MOD. 1 COMP.
LSI16BBBGR:
OMNIWASH SRL
LSI16CSLEX:
OMNIWASH SRL
LSI16EX:
OMNIWASH SRL

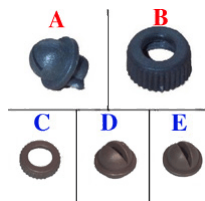
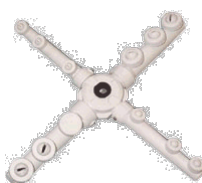

A= 3101009, B=3101010,
C=3101125, D=3101126,
E= 3101127

3112292 GIRANTE
CQ MOD. 2 BIANCA
COMP /
WASH ARM CQ MOD. 2
LSI26CSL:
OMNIWASH SRL -
SOCIETA' A SOCIO
UNICO
LSI26:
OMNIWASH SRL -
SOCIETA' A SOCIO
UNICO
LSI26BBBGR:
OMNIWASH SRL -
SOCIETA' A SOCIO
UNICO
LSI26BBB:
OMNIWASH SRL -
SOCIETA' A SOCIO
UNICO

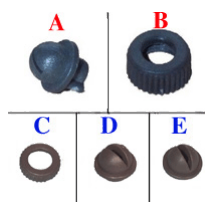

A= 3101009, B=3101010,
C=3101125, D=3101126,
E= 3101127,
DIMENSIONS
370X370mm

3112006 GIRANTE
CQ COMPLETA MOD 4
/
COMPLETE ROD
SQUARE BASKET MOD
4
LSI46BBBGR:
OMNIWASH SRL
LSI46:
OMNIWASH SRL
18010441:
NUOVA SIMONELLI
SPA

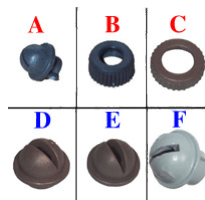

A= 3101009, B=3101010,
C=3101125, D=3101126,
E= 3101127, F=3101142,
DIMENSIONS
505X505mm

3112010 GIRANTE
COMPLETA 62P 4SA /
WASH ROD 62P 4SA
LSISA6BGR:
OMNIWASH SRL -
SOCIETA' A SOCIO
UNICO

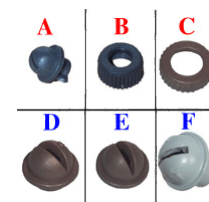

A= 3101009, B=3101010,
C=3101125, D=3101126,
E= 3101127, F=3101142,
DIMENSIONS
505X505mm

3112069 GIRANTE
LAVAGGIO/RISCIACQ
UO LS 385/605 /
WASH/RINSE ROD LS
385/605
15704063:
RANCILIO SPA
15704066:
RANCILIO SPA

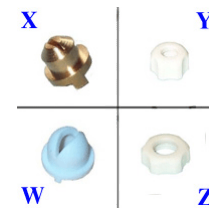
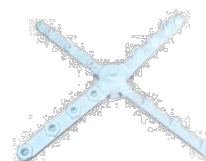

X=3101006, Y= 3101011,
W=3102016, Z=3102022

3112364 GRUPPO
LAV.+RIS.INF.COMP
P350/E/S/T /
LOWER WASH/RINSE
GROUP P350/E/S/T
30950:
SISTEMA PROJECT
SERVICE SRL

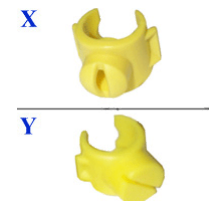

X= 3102046, Y=3101164

3112413 GIRELLO
LAVAGGIO/RISCIACQ
UO COMPLETO
MIX/TOP/BET37 /
WASH ARM
COMPLETE
MIX/TOP/BET37
2540:
UNIVER-BAR SRL

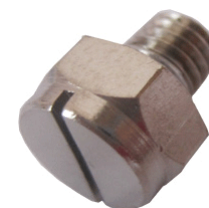

DIMENSIONS
385X385mm, = 3101171

3112418 GIRELLO
LAVAGGIO/RISCIACQ
UO COMPLETO
BET40/ERGON/MIDI40 /
WASH-RINSE ARM
COMPLETE
BETA40/ERGON/MIDI40
BET40/ERGON/MIDI
40:
UNIVER-BAR SRL

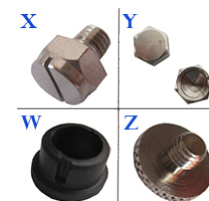

X= 3101171, Y=3101172,
W=2107156, Z=1141330,
DIMENSIONS
425X425mm

3112546 Girello
lavaggio/risciacquo
completo Sincro /
WASH-RINSE ARM
COMPLETE FOR
SINCRO
Sincro:
UNIVER-BAR SRL



X= 3101171, Y=3101172,
W=2107156, Z=1141330,
DIMENSIONS

465X455mm

3112414 GIRELLO
LAVAGGIO/RISCIACQ
UO COMPLETO
OMEGA/COSMO/COMP
ACT/SUP /
WASH ARM
COMPLETE
OMEGA/COSMO/COMP
ACT/SUP

3105:
UNIVER-BAR SRL



DIMENSIONS
485X470mm, = 3101171

3112448 GIRELLO
LAVAGGIO/RISCIACQ
UO COMPLETO
MIDI50/INF.LOGOS /
WASH ARM COMPL.
MIDI50/INF.LOGOS

3342:
UNIVER-BAR SRL



DIMENSIONS
505X475mm, = 3101171

3112460 LANCIA DI
LAV. TRIANGOLARE
COMPL.U61 /
WASH ARMS 3 WAYS
COMPLETE U61

929195:
ELETTROBAR



3112321 LANCIA DI
LAVAGGIO A 3
BRACCI GIREVOLE G /
WASH ROD

929196:
ELETTROBAR
DIVISIONE DELLA
EUROTEC SRL



3112626 MULINELL
O LAVAGGIO EDI 6-13
2° /

CRUISING WASHING
EDI 6-13 2nd
37543+4x37468:
HOONVED - ALI SPA



L braccio= 275 mm

3112594 ASS.
CROCERA
AP/PASSPORT 35.21 -
C/FORI LASERATI /
CRUISE WASH RINSE
COMPLETE AP /
PASSPORT 35.21 -
WITH HOLES LASER
CUT

AP/PASSPORT 35.21:
ARISTARCO SPA



A=4115413, B=2101387,
C=3101137, D= 4115414,
E=2101308,
DIMENSIONS 320mm

3112061 ASS.
CROCERA PASSPORT
38.25 /
WASH AND RINSE
ARM

PASSPORT
38.25,PASSPORT40.2
8,COMPACT
20,MASTER 22:
ARISTARCO SPA



BODY=4115132

3112066 ASSIEME
CROCERA PASSPORT
45.30 /
WASH RINSE ARM
ASSEMBLY PASSPORT
45.30

16117:
ARISTARCO SPA
PASSPORT 45..30:
ARISTARCO SPA



DIMENSIONS 430mm,
BODY=4115132

3112087 ASSIEME
CROCERA
PASSPORT/50.32
PIATTI /
WASH ROD
PASSPORT/50.32

PASSPORT 50.30:
ARISTARCO SPA
PASSPORT 50.30:
ARISTARCO SPA



DIMENSIONS 485mm,
BODY=4115132

3112355 MULINELL
O W.R.I.S. /
WASH ARMS W.R.I.S.
420578:
COMENDA ALI SPA



3112568 GRUPPO
LAV.RISC.BRACCI
PARALLELI E35 /
PARALLEL GROUP
WASH RINSE ARMS
E35

990111:
ELETTROBAR
DIVISIONE DELLA
EUROTEC SRL



DIMENSIONS 345mm

3112492 GRUPPO
LAVAGGIO -
RISCIACQUO BRACCI
PARALLELI E40 /
GROUP WASH - RINSE
ARMS PARALLEL E40

990110:
ELETTROBAR
DIVISIONE DELLA
EUROTEC SRL



L=395mm

3112645 LANCIA
BRACCI PARALLELI
COMPLETA /
RINSE/WASH ARM
BOSS 455 mm

69312:

ELETTROBAR



L=455mm

3112293 GIRANTE
PROJECT /
WASH ARM PROJECT

30950P:

SISTEMA PROJECT
SERVICE SRL



X



Y



X=3102046,Y= 3101164

3112515 GRUPPO
LAVAGGIO
RISCIACQUO
COMPLETO T150-155 /
GROUP WASH RINSE
COMPLETE T150-155

150950P:

SISTEMA PROJECT



DIMENSIONS 595mm

3112490 GRUPPO
LAV.+RIS.INF.COMP.
P400/E/S/T
PARALLELO /
WASH RINSE GROUP
P400

40950P:

SISTEMA PROJECT



3112566 ASS.
GIRELLO RISCIACQUO
AE 38/40 /
RINSE ARM
ASSEMBLY AE 38/40

AE 38/40:

ARISTARCO SPA



X



Y



Z



X= 4115414,Y=2101308,
Z=3101137,
DIMENSIONS 360mm

3114007 ASSIEME
GIRANTE PASSPORT
35.21 /
CRUISING ASSEMBLY
PASSPORT 35.21

4133:

ARISTARCO SPA



= 3101137

3112622 GIRANTE
RISC. COMPLETA AT
900 533MM /
COMPLETE RINSE
WHEEL AT 900 533MM

AT900: A.T.A. SRL



3112593 GIRANTE
RISCIACQUO
COMPLETA AT 1050
1100 - ALP 43 /
WHEEL FULL RINSE
AT 1050 1100 - ALP
43:

A.T.A. SRL



3112346 ASSIEME
RISCIACQUO AL03 /
RINSE ARM

7381: A.T.A. SRL



X



Y



W



Z



X=3101007, Y=3101015,
W= 3101016,Z=2101309

3112088 BRACCIO
DI RISCIACQUO
COMPLETO DI UGELLI
PER AF /
RINSE ARM
COMPLETE

4752: A.T.A. SRL



3112052 BRACCIO
RISCIACQUO AT95 /
RINSE ARM AT95

AT95, AT105:

A.T.A. SRL



3112097 MULINELL
O RISCIACQUOLC 380-
C140-C34 /
RINSE ROD LC 380-
C140-C34

430308:

COMENDA ALI SPA

33479:

HOONVED - ALI SPA



X



Y



X= 3101022,Y=3101023,
DIMENSIONS 505mm

3112113 MULINELL
O RISCIACQUO GL
MONT.COMENDA /
RINSE ARM GL
COMENDA

430323:

COMENDA ALI SPA



X



Y



X= 3101085,Y=2101310,
DIMENSIONS 595mm

3112154 MULINELL
O RISCIACQUO
UG.INOX C1000/1300 /
RINSE ARM FOR
C1000/1300

430316:

COMENDA ALI SPA



X



Y



X= 3101027,Y=2101132,
DIMENSIONS 490mm

3112089 MULINELLO
O RISCIAQUO
FC01/00 /
RINSING FAN FC01/00

430325:
COMENDA ALI SPA
430332:
COMENDA ALI SPA



X=3101084, Y=1117069,
Z= 2101137,
DIMENSIONS 500mm

3112369 MULINELLO
O RISCIAQUO
UGELLI PLASTICA
LC700/900/1200 /
RINSE ARM
LC700/900/1200

430343:
COMENDA ALI SPA



X=3101084, Y=1117069,
Z= 2101137

3112139 GRUPPO
RISCIAQUO
SUPERIORE SERIE 97 /
UPPER RINSE ROD
SERIES 97

DW16992: DIHR
EXDW10905: DIHR
DW10996: DIHR
DW10997: DIHR
DW16922: DIHR



X= 3101082, Y=2101123,
DIMENSIONS 300mm

3112147 GRUPPO
RISCIAQUO SUP/INF
03 DIHR /
UPPER/LOWER RINSE
INOX ROD 03 DIHR

DW75918EX:
DIHR-ALI SPA
DW75920:
DIHR-ALI SPA



X= 3101082, Y=3101152,
DIMENSIONS 460mm

3112045 ASTA
RISCIAQUO 048716 /
RINSE ARM 048716

048716EX:
ELECTROLUX
PROFESSIONAL
S.P.A.
0L2095:
ELECTROLUX
PROFESSIONAL
S.P.A.



3112518 GRUPPO
RISC.SUP.4
SPRUZZI(7012) /
UPPER RINSE ARM
(7012)

993036:
ELETTROBAR
DIVISIONE DELLA
EUROTEC SRL



3112297 GRUPPO DI
RISCIAQUO
SUPERIORE /
RINSE ARM WITH 4
NOZZLES S621

993031: ELETTROBAR

*:
MBM- EUROTEC SRL -
DIV. COOKING
SERVICE
REB993031:
LOTUS SPA
REB993031: COLGED
D993031: GIGA

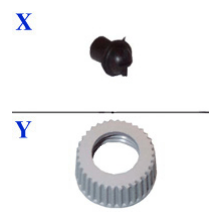

X= 3101067, Y=3101068,
DIMENSIONS 245mm,

3112274 PETTINE
RISCIAQUO RIVER
80/81 /
RINSE ARM RIVER
80/81

*:
MBM- EUROTEC SRL -
DIV. COOKING
SERVICE
80370: ELETTROBAR



X= 3101161, Y=2101308,
DIMENSIONS 510mm

3112206 LANCIA DI
RISCIAQUO
GIREVOLE COMPLETA
/
RINSE ARM

22F, 40F, E50, E51,
E52, E60, E100, E110,
E120, CLEAN100;
ELETTROBAR
10,12,66:
ELETTROBAR

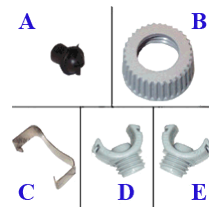

A= 3101067, B=3101068,
C=3101069, D=3101070,
E=3101071,
DIMENSIONS 470mm

3112519 GRUPPO
RISCIAQUO
INFERIORE 35 STEEL
INOX /
RINSE ARM 330MM

993057:
ELETTROBAR



3112473 GRUPPO
RISCIAQUO
INFERIORE 40 STEEL
INOX /
RINSING STAINLESS
STEEL UNIT LOWER 40

993058:
ELETTROBAR



3112646 LANCIA
RISCIAQUO
GIRANTE LP201/301
NM CPL. /
COMPLETE RINSE
ARM ASSEMBLY

42677:
ELETTROBAR
42211:
ELETTROBAR
DIVISIONE DELLA
EUROTEC SRL



L=640mm

3112308 GRUPPO
RISCIACQUO INOX
LG=500 RICAM /
RINSE ARM ROD
LG=500

00014194EX:
ELFRAMO SPA
00222295:
ELFRAMO SPA



3112096 ASTA RISC.
INFER.PREM. 43 /
LOWER RINSE ROD 43

21863:
HOONVED - ALI SPA



= 3101079

3112386 GRUPPO
RISCIACQUO INOX
LP70 RICAMBI /
STAINLESS STEEL
RINSE ARM LP70

00065294ex:
ELFRAMO SPA
LP70 : ELFRAMO SPA

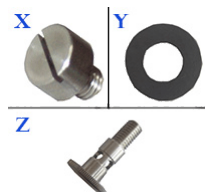

X= 3101160,Y=2107136,
Z=1141401

3112182 ASTA
RISC.INFER.PREM
53/60 /
RINSE ARM 53/60

21865:
HOONVED - ALI SPA



= 3101079

3112327 ASTA
RISCIACQUO INF.NP
60-80 /
LOWER RINSE ARM
NP60-80

9131548 + 903112:
GRUPPO CIMBALI
SPA
9131114EX:
GRUPPO CIMBALI
SPA



DIMENSIONS 490mm

3112403 ASTA
RISC.INFER.PREM.UN
60 /
RINSE ARM
COMPLETE 60

21145:
HOONVED - ALI SPA
32359+34351+2188:
HOONVED - ALI SPA



= 3101079

3112075 ASTA
RISCIACQUO
SUP.PREM.T3 /
RINSE ROD PREM.T3

20095:
HOONVED - ALI SPA



DIMENSIONS 280mm,
= 3101079

3112090 ASTA RISC.
INF. PREM.48 BY-PASS
/
LOWER RINSE ROD 48
BY-PASS

21130:
HOONVED - ALI SPA

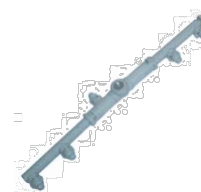

DIMENSIONS 405mm

3112076 ASTA
RISCIACQUO
INF.SUP.PREM.T3-4 /
LOWER/UPPER RINSE
ROD T3-4

20096:
HOONVED - ALI SPA



= 3101063

3112209 MULINELL
O RISCIACQUO INOX /
STAINLESS STEEL
RINSE ARM

CAP 12-CAP 12 DE-
CAP 12 EBT- ED 650E
- ED 650S:
HOONVED - ALI SPA



A B
C D E
A= 3101131, B=2101310,
C=2107065,D=4115560,
E= 1141321,
DIMENSIONS 495mm

3112345 ASTA
RISC.INF-
SUP.PREM.T4-5 /
RINSE ARM T4-5

20097:
HOONVED - ALI SPA



= 3101063

3112366 MULINELL
O RISC. INOX APS 48 /
STAINLESS STEEL
RINSE ARM APS 48

APS48:
HOONVED - ALI SPA



X
Y
X=3101084,Y= 1117069

3112399 MULIN.RIS.I
NOX
UGEL.PLAS.CAP10 /
RINSE ROD CAP 10

430344:
HOONVED - ALI SPA



DIMENSIONS 495mm

3112533 MULINELL
O RISCIAQUO EDI
6/13 /
RINSE ARM EDI6/13
EDI 6-EDI 8-EDI 13:
HOONVED - ALI SPA



A=3101144, B=3101085,
C=2101310, D=2107077,
E=1140154, F= 4120590

3112396 GIRANTE DI
RISC. COMPLETA DI
BUSSOLE /
RINSE ARM KPL.
800800K:
KRUPPS S.R.L.
800800EX:
KRUPPS S.R.L.



= 3101165

3112438 MULINELL
O RISCIAQUO
SUPERIORE /
UPPER RINSE ARM
0200804:
LAMBER DI AFFABA
FRANCESCO & C.



= 3101093

3112455 GIRANTE
RISC. INFERIORE /
LOWER RINSE ARM
0200296:
LAMBER DI AFFABA
FRANCESCO & C.



DIMENSIONS 375mm,
= 3101146

3112524 MULINELL
O RISC.INFERIORE F-L
6324/6326 /
LOWER RINSE ARM F-
L-6324/6326
0200287:
LAMBER DI AFFABA
FRANCESCO & C.



= 3101093

3112581 ASSIEME
RAMPA RISCIAQUO
NEW X 95L
COMPLETA /
RAMP RINSE
ASSEMBLY
COMPLETE NEW X 95L
2341021: LASA SRL



3112027 GIRANTE
RISCIAQUO SUP.
LT285 /
UPPER RINSE ROD
LT285
LT255,LT285:
RANCILIO SPA
15704045:

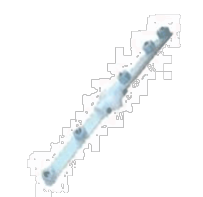

RANCILIO SPA

X= 3101006, Y= 3101011

3112085 GIRANTE
LAVAGGIO MOD.PCBA
+MOZZO+GHIERA
SILANOS /
WASH ROD
MOD.PCBA SILANOS
SVELTINA:
SILANOS SRL



L=333mm

3112054 GIRANTE
RISCIAQUO COMPL.
F27/C40 dare perno
1140031 /
COMPLETE RINSE
ROD F27/C40
903015:
SILANOS SRL



A=3101008, B=2101047,
C=3101059, D=4115008,
E= 1140031, L=380mm

3112101 GIRANTE
RISCIAQUO 600 N45
COMPLETA /
COMPLETE RINSE
ROD 600 N45
903016:
SILANOS SRL



DIMENSIONS 430mm,
= 3101008

3112102 GIRANTE
RISCIAQUO N19
COMPLETA 330MM
DARE ANCHE 1141365 /
COMPLETE RINSE
ARM ASSEMBLY 330
mm
903009:
SILANOS SRL



L= 330mm,
SHAFT=1141365

3112586 GRUPPO
RISCIAQUO
SUPERIORE
COMPLETO P350/400 -
E/S35 /
COMPLETE UPPER
RINSE GROUP P350/400
- E/S35
30960:
SISTEMA PROJECT
SERVICE SRL



3112487 GIRELLO
RISCIAQUO
SUPERIORE
COMPLETO
ERGON/BET40 /
UPPER RINSE ARM
ERGON/BET40
ERGON/BET40:
UNIVER-BAR SRL



DIMENSIONS 420mm,
= 3101171

3112412 GIRELLO
RISCIACQUO
SUPERIORE
COMPLETO
MIX/TOP/BET37 /
RINSE ARM
COMPLETE
MIX/TOP/BET37
3259:
UNIVER-BAR SRL



DIMENSIONS 375mm,
= 3101117

3112502 ASS.
CROCERA LAVAGGIO
PIATTI GL 1040 /
WASH ARM GL 1040
2757:
ARISTARCO SPA



3112198 MULINELL
O LAVAGGIO C1000-
C95 /
WASH ARM C1000-C95
420540:
COMENDA ALI SPA



DIMENSIONS 500mm

3112662 GRUPPO
LAVAGGIO
RISCIACQUO
INFERIORE /
LOWER WASH/RINSE
ROD
990113:
ELETTRORAR
DIVISIONE DELLA
EUROTEC SRL



L=495mm

3112191 ASTA
LAVAGGIO IF.-SUP.
PRE AP43/53 /
UPPER LOWER WASH
ARM AP43/53
21866:
HOONVED - ALI SPA

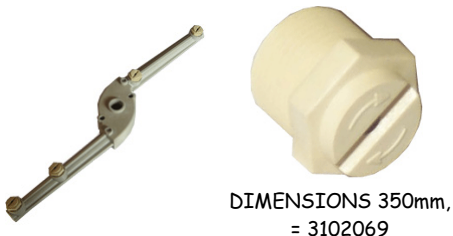

DIMENSIONS 350mm,
= 3102069

3112226 ASTA
LAVAGGIO SUPER. 43 /
UPPER WASH ARM 43
AP 43:
HOONVED - ALI SPA



X=3102069,Y=4115597,
W=4115447, Z=1141089

3112059 ASTA
LAVAGGIO
INFERIORE AP48 /
WASH ARM LOWER
AP48
21867:
HOONVED - ALI SPA

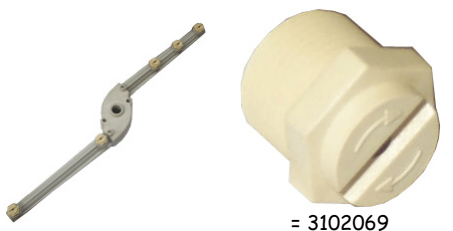

= 3102069

3112405 ASTA
LAVAG.SUP.INF.PREM.
AP 60 /
WASH ARM UPPER AP
60
21884:
HOONVED - ALI SPA



= 3102069

3112256 MULINELL
O LAV. SUP. INOX
APS43 /
UPPER WASH ARM
APS43
APS43/48753:
HOONVED - ALI SPA



DIMENSION=295mm

3112365 MULINEL.L
AV.INFAPS48-
SUP53INOX /
WASH ARM APS48- 53
36219:
HOONVED - ALI SPA



3112395 GIRANTE DI
LAVAG. COMPLETA DI
BUSSOLE /
WASH ARM
COMPLETE
800851K:
KRUPPS S.R.L.
800855K:
KRUPPS S.R.L.
800851KEX:
KRUPPS S.R.L.
800850EX:
KRUPPS S.R.L.
800850KEX:
KRUPPS S.R.L.

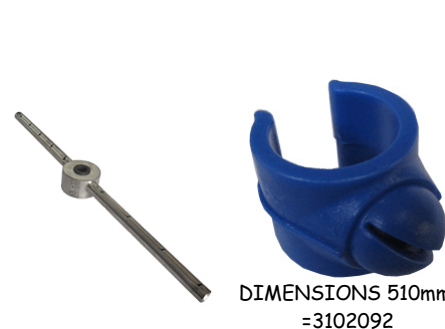

DIMENSIONS 510mm,
=3102092

3112018 GIRANTE
LAV 7-8-9
8G+2B+2T+10 /
WASH ARM 7-8-9
8G+2B+2T+10
902951:
SILANOS SRL

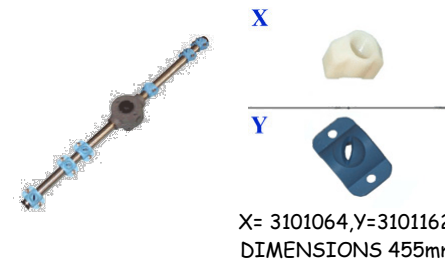

X= 3101064,Y=3101162,
DIMENSIONS 455mm

3112048 GIRANTE
LAVAGGIO 600
+8G+2B+2T /
WASH ROD
600+8G+2B+2T
902941:
SILANOS SRL

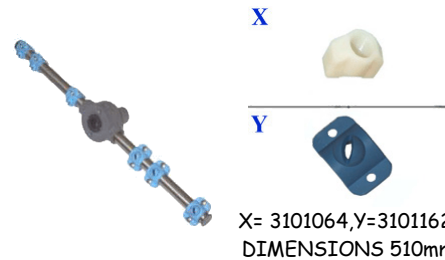

X= 3101064,Y=3101162,
DIMENSIONS 510mm

3112529 GIRANTE
LAVAGGIO AF61/78/88
/
WASH ARM AF61/78/88
4365: A.T.A. SRL



3112098 MULINELL
O
LAV.MONTATO"LC/C"
PIATTO /
WASH ARM LC/C

420572R:
COMENDA ALI SPA
420554:
COMENDA ALI SPA
420511**:
COMENDA ALI SPA
17085:
HOONVED - ALI SPA



DIMENSIONS 535mm

3112159 MULINELL
O LAV.INOX"FC" C75 /
"STAINLESS STEEL
WASHING FAN ""FC""
C75"

420548:
COMENDA ALI SPA
420548:
HOONVED - ALI SPA



DIMENSIONS 505mm

3112146 GIRANTE
LAVAGGIO 1200S /
WASH ROD 1200S
DW10600900:
DIHR-ALI SPA



3102059 GETTO
LAVAGGIO ASS. /
WASH ARM
048821EX:
ELECTROLUX.
0L0598:
ELECTROLUX
PROFESSIONAL
S.P.A.



L=483mm

3112030 GIRANTE
LAVAGGIO E52/22F
ELETTROBAR /
WASH ROD E52/22F
ELETTROBAR
E50, E51, E52:
ELETTROBAR
DIVISIONE DELLA
EUROTEC SRL



3112034 GRUPPO
PETTINE LAVAGGIO
810/22 /
WASH ARM 810/22/
44F, 440F, 22F, 40F:
ELETTROBAR
DIVISIONE DELLA



EUROTEC SRL

3112520 PETTINE
LAVAGGIO
INFERIORE EB CL.3 /
LOWER WASH ARM
EB CL.3
129034:

ELETTROBAR
DIVISIONE DELLA
EUROTEC SRL



3112392 GRUPPO
PETTINE LAVAGGIO
X5 510 mm /
STAINLES STEEL
WASH ARM
ASSEMBLY INOX 510
mm

990107:
ELETTROBAR
DIVISIONE DELLA
EUROTEC SRL

990107:
MBM- EUROTEC SRL -
DIV. COOKING
SERVICE



DIMENSIONS 510mm

4115878 PETTINE
LAVAGGIO RIVER
CAPOT /
WASH ARM

*:
EUROTEC SRL - DIV.
COOKING SERVICE
MBM
80311:
ELETTROBAR
DIVISIONE DELLA
EUROTEC SRL



3112358 COLLETTO
RE LAV. BD14 LG=400
RICAMBI /
WASH ARM BD14
LG=400
00222000:
ELFRAMO SPA



DIMENSIONS 400mm

3112656 COLLETTO
RE LAV. INOX D30
LG=485 RICAMBI /
STAINLESS STEEL
WASH ARM ASSY D30
LG=485
00014045:
ELFRAMO SPA



L=485mm

3112500 COLLETTO
RE LAVAGGIO D80
LG=485 RICAMBI /
WASH ARM
ASSEMBLY D80
L=485mm
00014048:
ELFRAMO SPA



L=485mm

3112099 COLLETTO
RE LAVAGGIO INOX
C44 LG=535 /
STAINLESS STEEL
WASH ROD C44
LG=535
00016851:
ELFRAMO SPA



DIMENSIONS 535 mm

3112016 ASTA
LAVAGGIO INF. NP60-
80-120 /
WASH ROD NP60-80-
120
NP60-80-120:
GRUPPO CIMBALI
SPA
977540000:
GRUPPO CIMBALI
SPA



3112231 ASTA
LAVAGGIO PICCOLA
HMRSN /
WASH ROD
HEMERSON
9131022:
GRUPPO CIMBALI
SPA
984716000:
GRUPPO CIMBALI
SPA



DIMENSIONS 380mm

3112343 MULINELL
O LAVAGGIO 43 /
WASH ARM 43
17974:
HOONVED - ALI SPA



3112044 MULINELL
O LAVAGGIO INF48
SUP53 /
WASH ROD LOWER48
UPPER53
17975:
HOONVED - ALI SPA



DIMENSIONS 415mm

3112177 MULINELL
O LAVAGGIO SUP/INF
60 HOONVED /
WASH ARM 60
HOONVED
33586:
HOONVED - ALI SPA



DIMENSIONS 480mm

3112525 BRACCIO
DI LAVAGGIO /
WASHING ARM
0500500:
LAMBER DI AFFABA
FRANCESCO & C.



3112127 PALA
LAVAGGIO LT 205 /
WASHING BLADE
LT205
15033929:
RANCILIO SPA



DIMENSIONS 415mm

3112100 GIRANTE
LAV.INOX
600+MOZZO+GHIERA /
STAINLESS STEEL
WASH ROD 600
903106:
SILANOS SRL



DIMENSIONS 435mm

3112032 GIRANTE
LAVAGGIO V50-7-8-9-
100 /
WASH ROD V50-7-8-9-
100
903107:
SILANOS SRL
30Z2680:
ANGELO PO GRANDI
CUCINE SPA



DIMENSIONS 495mm

3112079 GIRANTE
LAVAGGIO
1300+MOZZO+GHIERA
/
WASH ROD
1300+HUB+METAL
RING
902961:
SILANOS SRL



DIMENSIONS 535mm

3112288 BRACCIO
LAVAGGIO /
WASH ARM
WINTERHALTER
60003520:
WINTERHALTER
ITALIA SRL



3112591 " GIRANTE
RISCIACQUO INOX 4
""2013"" " + PERNO /
"RINSE IMPELLER
INOX 4" "2013" "" + PIN
30Z1491: ANGELO PO
GRANDI CUCINE SPA



3112590 " GIRANTE
RISCIACQUO INOX 4
""2013"" " /
STAINLESS STEEL
RINSING ARM 4"
"2013" ""
903028:
SILANOS SRL
30Z1491:
ANGELO PO GRANDI
CUCINE SPA



3112637 GIRANTE
RISCIACQUO 1 PPL
SILANOS L 330mm /
RINSE WHEEL
SILANOS 330MM
907955:
SILANOS SRL



DIMENSIONS 330mm

3112553 GIRANTE
RISC. 2 PPL /
RINSE ARM 2 PPL
907956:
SILANOS SRL



L=380mm

3112053 GIRANTE
LAVAGGIO F27/C40 /
WASH ROD F27/C40
903105:
SILANOS SRL



DIMENSIONS 395mm

3112648 GIRANTE
RISCIACQUO 3 PPL
430mm /
RINSE ARM 430mm
907957:
SILANOS SRL



L=430mm

3112453 GIRANTE
RISCIACQUO 4 PPL
490mm /
RINSE ARM 490mm
907958:
SILANOS SRL



L=490mm

3112659 BRACCIO
DI LAVAGGIO /
WASH ARM
ASSEMBLY
30002770:
WINTERHALTER
ITALIA SRL



L=515mm

3112650 BRACCIO
RISCIACQUO
MONTATO AC91/122 /
RINSE ARM
ASSEMBLED AC91 /
122
430186:
COMENDA ALI SPA



L=525mm

3112340 BRACCIO
RISC.MONT.AC151=242
/
RINSE ARM AC151=242
430185:
COMENDA ALI SPA



3112583 BRACCIO
RISCIACQUO UGELLI
M5 PER ACL /
RINSE ARM FOR
NOZZLE M5 ACL
430226:
COMENDA ALI SPA



3112445 GETTO
RISCIACQUO /
RINSE ARM
049297:
ELECTROLUX
PROFESSIONAL
S.P.A.



3112494 BRACCIO
RISC.SX CAVA 10 DS
400 /
RINSE ARM SX FOR
DS400
12171: ADLER S.P.A.



3112495 BRACCIO
RISC.DX CAVA 8 DS
400 /
RINSE ARM DX FOR
DS400
12170: ADLER S.P.A.



3112612 BRACCIO
RISCIACQUO SX == /
ARM RINSE SX
7369: A.T.A. SRL



NOZZLE=3102127

3112613 BRACCIO
RISCIACQUO DX == /
ARM RINSE DX
7368: A.T.A. SRL



NOZZLE=3102127

3112384 BRACCIO
DI RISCIACQUO PER
LAVABICCHIERI /
RINSE ARM
106001:
ELETTROBAR
DIVISIONE DELLA
EUROTEC SRL



3112301 BRACCIO
RISCIACQ.1FORO
66/22F(INOX) /
RINSE ARM 66/22F
106053:



ELETTROBAR
DIVISIONE DELLA
EUROTEC SRL

*:
MBM- EUROTEC SRL -
DIV. COOKING
SERVICE

3112600 PETTINE
RISCIACQ.PLASTICA
E45/CAPOT /
RINSE CRUISING
PLASTIC E45 / CAPOT
129079: ELETTROBAR



DIMENSIONS 435mm

3112057 BRACCIO
RISCIACQUO 1°
INCLIN. CPL /
00011163:
ELFRAMO SPA
00011187ex:
ELFRAMO SPA



DIMENSIONS 195mm

3112470 BRACCIO
RISC. SQ 160
1ØDIRITTO RICA /
00011186ex:
ELFRAMO SPA
00011163: ELFRAMO
SPA



3112404 COLLETTO
RE RISCIACQUO ETS /
RINSE TOP BOSS FOR
ETS
ETS: ELFRAMO SPA



3112458 Z201902000
BRACCIO
RISCIACQUO
SINISTRO /
Z201902000 RINSE
ARM LEFT
Z201902000EX:
FAGOR
INDUSTRIALE S.R.L.
12022442:
FAGOR
INDUSTRIALE S.R.L.



3112459 Z201901000
BRACCIO
RISCIACQUO DESTRO
/
Z201901000 RIGHT
RINSE ARM
12022441:



FAGOR
INDUSTRIALE S.R.L.
Z201901000EX:
FAGOR
INDUSTRIALE S.R.L.

3112235 COPPIA
BRACCI
INF.RISC.NP43-48-49 /
RINSE ARMS NP 43-48-
49
9131126ex:
GRUPPO CIMBALI
SPA
9131542:
GRUPPO CIMBALI
SPA



3112236 COPPIA
BRACCI INFERIORE
RISCIACQUO NP 60-80-
120 /
PAIR RINSE ARMS NP
60-80-120
9131131:
GRUPPO CIMBALI
SPA



L=231mm cadauno

3112237 COPPIA
BRACCI
RISC.INF.NAP* /
RINSE ARMS NAP*
986515000+986516:
GRUPPO CIMBALI
SPA
9131266:
GRUPPO CIMBALI
SPA



3112644 RINSE ARM
/
RINSE ARM
012452581:
HOBART GmbH



L=660mm

3112284 BRACCIO
ASTA RISC.4/I-5/S /
RINSE ARM ROD 4/I-
5/S
32178:
HOONVED - ALI SPA



3112285 BRACCIO
ASTA RISC.4/I-5/S /
RINSE ARM ROD 4/I-
5/S
32179:
HOONVED - ALI SPA



3112291 BRACCIO
ASTA RISC.3/I-4/S /
RINSE ARM 3/I-4/S
32177:
HOONVED - ALI SPA



3112326 BRACCIO
ASTA RISC.3/I-4/S /
RINSE ROD ARM 3/I-
4/S
32176:
HOONVED - ALI SPA



3112318 BRACCIO
RISC. INFERIORE /
RINSE ARM BELOW
33794:
HOONVED - ALI SPA



3112406 BRACCIO
RISC. SUPERIORE /
UPPER RINSE ARM
33789:
HOONVED - ALI SPA



3112371 ASTA RISC.
CQ 1 DX/SX C/GETTI
BIANCA /
RINSE ARM CQ 1
LSI16CDSBGR:
OMNIWASH SRL -
SOCIETA' A SOCIO
UNICO



DIMENSIONS 130mm

3112217 ASTA RISC.
CQ 2 DX C/GETTI
COMP /
RINSE ARM WITH
NOZZLES
LSI26CDBGR:
OMNIWASH SRL -
SOCIETA' A SOCIO
UNICO
LSI26CD:
OMNIWASH SRL -
SOCIETA' A SOCIO
UNICO



DIMENSIONS 155mm

3112305 ASTA RISC.
CQ 2 SX C/GETTI GR /
WHITE RINSE ARM L
160mm 3 NOZZLES
LSI26CSBGR:
OMNIWASH SRL -
SOCIETA' A SOCIO
UNICO



DIMENSIONS 160mm

3112247 ASTA
LAVAG. CT 1 S/I
(BRAC) BIANCA
STAMPO 32 UNI /
WASH ARM CT 1 S/I
GL1T28PBGR:
OMNIWASH SRL -
SOCIETA' A SOCIO
UNICO



DIMENSIONS 205mm

3112393 ASTA
LAVAG. CT 2A INF.
BIANCA C/GETTI
COMP /
WASH ARM NOZZLES
4 PIECES WHITE
GL2T28PBGR:
OMNIWASH SRL
GL2T28BCMGR:
OMNIWASH SRL -
SOCIETA' A SOCIO
UNICO



X



Y



X=3102002,Y=3102003,
DIMENSIONS 220mm

3112354 ASTA RISC.
CQ 4-6 DX C/GETTI
BIANCA /
RINSE ARM RIGHT
WITH NOZZLES
WHITE
LSI46CDBGR:
OMNIWASH SRL -
SOCIETA' A SOCIO
UNICO



DIMENSIONS 225mm

3112351 TUBO
Ø10X1X190 RIS.SX. 40-
400 /
RINSE ARM ?10X1X190
SX. 40-400
40400:
SISTEMA PROJECT
SERVICE SRL



= 3101164

3112352 TUBO
Ø10X1X190 RIS.DX. 40-
400 /
RINSE ARM ?10X1X190
DX. 40-400
40390:
SISTEMA PROJECT
SERVICE SRL



= 3101164

3112610 BRACCIO
LAVAGGIO INF. SX ==
/
ARM WASHING
LOWER LEFT
7352: A.T.A. SRL



NOZZLE=3101189

3112611 BRACCIO
LAVAGGIO
INFERIORE DX == /
ARM WASHING
LOWER RIGHT
7370: A.T.A. SRL



NOZZLE=3101189

3112587 TUBO
LAVAGGIO
SUPERIORE B23-10-
LBR /
UPPER TUBE
WASHING B23-10-LBR
170604:
COMENDA ALI SPA



3112641 COLONNA
LAVAGGIO AC2 /
WASHING COLUMN
AC2
333200:
COMENDA ALI SPA



L=840mm

3112557 BRACCIO
LAV.CORTO AC91/101 /
SHORT WASH ARM
AC91/101
AC91/101:
COMENDA ALI SPA



X= 3102123,Y=4115602,
Z=3112337

3112337 BRACCIO
LAVAGGIO LUNGO
S90_SNUOV.L /
WASH ARM LONG
S90_SNUOV.L
H170612:
HOONVED - ALI SPA
170612:
COMENDA ALI SPA



3112339 BRACCIO
LAVAGGIO 2 UGELLI /
WASH ARM 2 JETS
170627:
COMENDA ALI SPA



3112338 BRACCIO
LAV. 3 UGEL. S NL /
WASH ARM 3 JETS
170626:
COMENDA ALI SPA



3112571 BRACCIO
LAVAGGIO LUNGO
S90-S NUOV.L /
WASH ARM LONG S90-
S NUOV.L
H170611:
HOONVED - ALI SPA
170611:
COMENDA ALI SPA



3112558 BRACCIO
LAV.INF.AC91/101 /
LOWER WASH ARM
AC91/101
AC91/101:
COMENDA ALI SPA



X=3102070,Y=4115602,
Z=3112571

3102098 GETTO
LAVAGGIO /
WASH JET
049295:
ELECTROLUX
PROFESSIONAL
S.P.A.



3112383 BRACCIO
LAVAGGIO INF. S624 /
WASHING ARM, LOW.
S624
106003:
ELETTROBAR
DIVISIONE DELLA
EUROTEC SRL



3112575 BRACCIO
LAVAGGIO/RISCIACQ
UO
.E35(5SPR)P.PARALLEL
I /
ARM WASH / RINSE.
E35 (5SPR) PARALLEL
106147:
ELETTROBAR
DIVISIONE DELLA
EUROTEC SRL



3112576 BRACCIO
LAVAGGIO
/RISCIACQUO
E35(5SPR)PARALLALL
ELO TIPO A /
RINSE/WASH ARM E35
PARALLEL
106146:
ELETTROBAR
DIVISIONE DELLA
EUROTEC SRL



3112538 TUBO INOX
D.12X1 L.215 C/3 FORI /
STEEL PIPE D.12X1
L.215 C / 3 HOLES
SLBR501: FABAR SRL



3112521 TUBAZ.LAV
AGGIO
I°PZ.MOD.T39I/S /
WASH TUBE
MOD.T39I/S
05063B: FABAR SRL



3112522 TUBAZIONE
/ WASH TUBE
05064: **FABAR SRL**



3112092 ASTA
LAVAGGIO
SUPERIORE 43 /
UPPER WASH ROD 43
9021014:
**GRUPPO CIMBALI
SPA**



X=3102005,Y=3112006,
DIMENSIONS
210X50mm

3112093 ASTA
LAVAGGIO
SUPERIORE 48 / UPPER
WASH ROD 48
9021102: **GRUPPO
CIMBALI SPA**



X=3102005,Y=3102006,
DIMENSIONS
245X110mm

3112077 ASTA
LAVAGGIO METALLO
43-48 /
METAL WASH ROD 43-
48
9021011:
**GRUPPO CIMBALI
SPA**



DIMENSIONS 375mm

3112094 ASTA
LAVAGGIO
INFERIORE 43 /
LOWER WASH ROD 43
9021013:
**GRUPPO CIMBALI
SPA**



X= 3102005,Y=3102006

3112095 ASTA
LAVAGGIO
INFERIORE 48 /
LOWER WASH ROD 48
9021103:
**GRUPPO CIMBALI
SPA**



X= 3102005,Y=3102006

3112240 ASTA
LAVAGGIO
INFERIORE CROMATA
SAP 43-48 /
LOWER WASH ROD
SAP 43-48
9131387:
**GRUPPO CIMBALI
SPA**
9131259:
GRUPPO CIMBALI



L=183mm cadauno

SPA
537054200:
**GRUPPO CIMBALI
SPA**

3112239 COPPIA
ASTE LAVAGGIO
INFERIORE NAP 60 /
BELOW WASH ROD
NAP 60
537054600:
**GRUPPO CIMBALI
9131475:
GRUPPO CIMBALI**



DIMENSIONS 215mm
2 Pz.

3112619 PALA ASTA
LAVAGGIO
SUPERIORE ED700 /
WASHING AND UPPER
ARM 700
21539:
HOONVED - ALI SPA



oring=2101317,
getto=3102109

3112275 ASSIEME
RAMPA LAVAGGIO 5-
50 /
WASH ARM 5-50
2610060: **LASA SRL**



3112280 ASSIEME
RAMPA LAVAGGIO
LS3-30 /
WASH ARM L 190mm
NOZZLES 4 ? 32mm
2610010: **LASA SRL**



3112253 BRACCIO
LAVAGGIO K1000-1300
ø 25x215 mm /
WASH ARM K1000-
1300 A ø 25x215 mm
L5040: **LUXIA SRL**



DIMENSIONS 215mm

3112254 BRAC.LAV.
1000-1300 B DIM.20X19
/
WASH ARM 1000-1300
B DIM. 20X19
L5041:
LUXIA GROUP SRL



3112042 COLONNA
LAVAGGIO MOD. 1-2 /
WASH ROD MOD. 1-2
Z100P004:
S.V. ITALIA SRL
GL1T27BGR:
OMNIWASH SRL
18010013:
NUOVA SIMONELLI
SPA



O-RING=2101402,
DIMENSIONS 380mm,
NUT=1141063

3112334 ASTA
LAVAG. CQ 1 SX
C/GETTI /
WASH ARM
LSI16BSBGR:
OMNIWASH SRL -
SOCIETA' A SOCIO
UNICO



DIMENSIONS 130mm

3112230 ASTA
LAVAG. CQ 1 DX C
GETTI /
WASH ARM CQ1 DX
WITH JETS
LSI16BDBGR:
OMNIWASH SRL -
SOCIETA' A SOCIO
UNICO



DIMENSIONS 130mm

3112216 ASTA
LAVAG. CQ 2 DX
C/GETTI COMP /
WASH ARM CQ2 DX
WITH JETS
LSI26BDBDS:
OMNIWASH SRL -
SOCIETA' A SOCIO
UNICO
LSI26BD:
OMNIWASH SRL -
SOCIETA' A SOCIO
UNICO

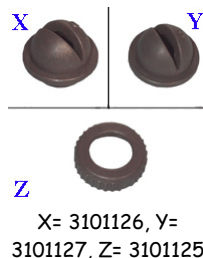

3112306 ASTA
LAVAG. CQ 2 SX
C/GETTI COMP /
WASH ARM CQ2 SX
WITH JETS
LSI26BS:
OMNIWASH SRL
LSI26BSBDS:
OMNIWASH SRL



3112638 ASTA
LAVAGGIO CQ 4 SX
CON GETTI GRIGI /
LEFTHAND WASH
ARM CQ4 SX
LSI46BSBGR:
OMNIWASH SRL -
SOCIETA' A SOCIO
UNICO

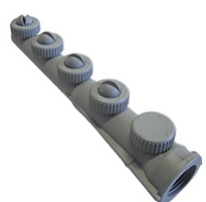

3112639 ASTA
LAVAGGIO CQ 4 DX
CON GETTI GRIGI /
RIGHTHAND WASH
ARM CQ4 DX
LSI46BDBGR:
OMNIWASH SRL -
SOCIETA' A SOCIO
UNICO



DIMENSIONS 223mm,
=3112638

3112634 ASTA
LAVAGGIO CQ 4SA-
62P SX CON GETTI /
LEFTHAND WASH
ARM
LSISA6BSBGR:
OMNIWASH SRL -
SOCIETA' A SOCIO
UNICO

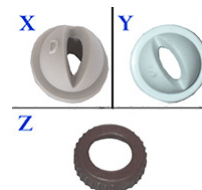
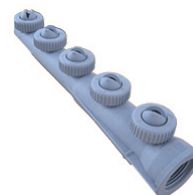

3112635 ASTA
LAVAGGIO CQ 4SA-
62P DX CON GETTI GR
/
RIGHTHAND WASH
ARM
LSISA6BDBGR:
OMNIWASH SRL -
SOCIETA' A SOCIO
UNICO

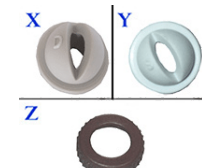

3112252 ASTA
LAVAGGIO
SUPERIORE INOX /
WASH ARM
COMPLETE
GL2AT28BCMU:
OMNIWASH SRL -
SOCIETA' A SOCIO
UNICO



3112019 COLONNA
LAVAGGIO R20
SILANOS /
WASH ROD R20
SILANOS
901716:
SILANOS SRL



DIMENSIONS 370mm,
= 2101569

3112068 COLONNA
LAVAGGIO R23/R41
SILANOS /
WASH COLUMN
R23/R41 SILANOS
901713:
SILANOS SRL



3112023 BRACCIO
LAVAGGIO
SUP.RUB.LYLY /
UPPER WASH ROD
LYLY
R20-R20A:
SILANOS SRL



3112024 BRACCIO
LAVAGGIO INF. LYLY
/
LOWER WASH ROD
LYLY
900116:
SILANOS SRL

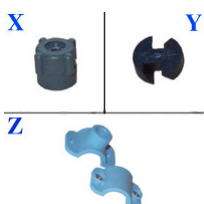

X= 3102012,
Y=3102013, Z=
3102043,
DIMENSIONS 195mm

3112067 BRACCIO
LAVAGGIO
SUPERIORE R23/R41
SILANOS /
UPPER WASH ARM
R23/R41 SILANOS
900112:
SILANOS SRL



X=3102013, Y=
3102012, Z= 3102043

3112273 BRACCIO
LAVAGGIO
SUPERIORE R 29 /
UPPER WASH ARM - R
29
R29: SILANOS SRL



A= 3102043,
B=3102012, C= 3102013,
D=4115066, E= 2101314,
DIMENSIONS
220X135mm

4120699 DIRAMAZIO
NE DI LAVAGGIO
INFERIORE /
LOWER WASH
BRANCH
65004825:
WINTERHALTER
ITALIA SRL



L=540mm

3112658 RAMPA
LAVAGGIO PASSPORT
40.28 /
RAMP WASH
PASSPORT 40.28
2277:
ARISTARCO KASTEL
SPA



DIMENSIONS
580X220mm

3112601 BRACCIO
DI RISCIAQUO /
ARM RINSE
0E5945:
ELECTROLUX
PROFESSIONAL
S.P.A.



3112584 TUBAZIONE
RISCIAQUO T53S /
PIPE RINSING T53S
09127G: FABAR SRL



3112574 TUBAZIONE
RISCIAQUO T53F /
HOSE CLEANING T53F
09127D: FABAR SRL



4120207 TUBAZIONE
RISCIAQUO T39I/S /
RINSE PIPE T39I / S
09127B: FABAR SRL



3112078 ASTA
RISCIAQUO MOD. 43 /
RINSE ROD MOD. 43
9021019:
GRUPPO CIMBALI
SPA

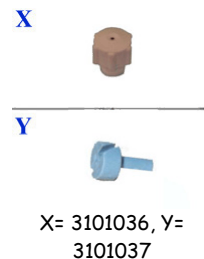
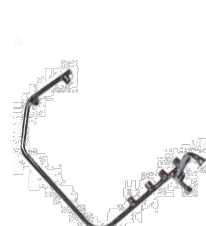

X= 3101036, Y=
3101037

3112082 ASTA
RISCIAQUO 48 /
RINSE ROD 48
9021101:
GRUPPO CIMBALI
SPA

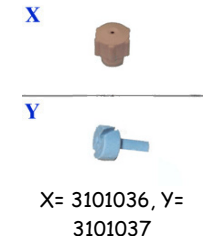

X= 3101036, Y=
3101037

3112330 ASTA
RISCIAQUO PRE-
MONTATA 36 /
ARM RINSE PRE-
MOUNTED 36
20076:
HOONVED - ALI SPA



3112398 ASTA RISC.
CT 1A C/GETTI COMP /
RINSE ARM
COMPLETE



X= 3101002, Y=3101003,
W=3101004, Z=3101005

3112225 ASTA
RISCIACQUO R20-
SUPERBAR /
RINSE ROD R20-
SUPERBAR
R20-R20A:
SILANOS SRL



= 3101076

3112200 ASTA
RISCIACQUO R 29 /
RINSE ARM R 29
R29: SILANOS SRL



= 3101076

3112229 ASTA
RISCIACQUO LYLY
RUBINIA /
RINSE ARM LYLY
RUBINA
AMBRA:
SILANOS SRL



= 3101076

3112029 ASTA
RISCIACQUO R20
SILANOS /
RINSE ROD R20
SILANOS
900145:
SILANOS SRL



3112104 TUBO
LAVAGGIO
INFERIORE B23-10-BR
COMENDA /
TUBE WASHING
LOWER B23-10-BR
COMENDA
170603:
COMENDA ALI SPA

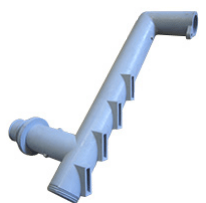

L=250mm

3112630 RAMPA
LAVAGGIO C90E 2007 /
WASHING RAMP C90E
2007
c90:
COMENDA ALI SPA
37237:
HOONVED - ALI SPA



3112554 RAMPA
LAVAGGIO C/LC
ANNO2001 /
RAMP WASH C / LC
ANNO2001
420423:
COMENDA ALI SPA
420423:
HOONVED - ALI SPA



3112651 COLLETO
RE LAVAGGIO
INFERIORE DX AC /
COLLECTOR LOWER
WASHING DX FOR AC
332212:
COMENDA ALI SPA



DIMENSIONS
475X385mm

3112652 COLLETO
RE LAVAGGIO
SUPERIORE .DX AC /
COLLECTOR
SUPERIOR WASH DX
AC
332213:
COMENDA ALI SPA



DIMENSIONS
526X407mm

3112381 GRUPPO
LAVAGGIO /
WASHING ROD
049945:
ELECTROLUX
*: ELECTROLUX

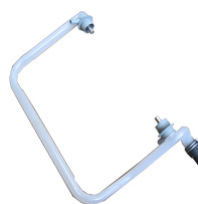

3112511 PETTINE
LAV.SUP.PLASTICA
E.40 CPL. /
UPPER WASHING
COLLECTOR E.40 CPL
990095EX:
ELETTOBAR



3112426 CONDOTTA
LAV.EST.CPL.E50-503
BRACCI/P. /
WASHING ARM CPL.
E50-503
115131:
ELETTOBAR
DIVISIONE DELLA
EUROTEC SRL



3112633 ASTA
LAVAGGIO
SUPERIORE SAP 48* /
UPPER WASHING PIPE
SAP48
9131568:
GRUPPO CIMBALI
SPA
986520000:
GRUPPO CIMBALI
SPA



3112055 ASTA
LAVAGGIO PREM. 40-
42 /
ROD WASH 40-42
20106:
HOONVED - ALI SPA

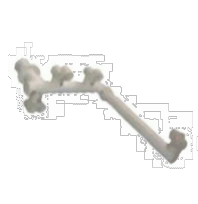

= 3102058

3112184 ASTA
LAVAGGIO
PREMONTATA 48 /
WASH ARM FIXED 48
20107:
HOONVED - ALI SPA



3112039 TUBO
LAVAGGIO LT 200-220
/
WASH ROD LT 200-220
15704122:
RANCILIO SPA

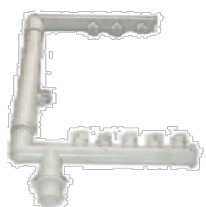

X= 3102005,
Y=3102006

3112503 DIRAMAZIO
NE DI LAVAGGIO
SUPERIORE /
UPPER WASH
COLLECTOR
61005189:
WINTERHALTER
ITALIA SRL



3112559 COLONNA
LAVAGGIO
N1000/N1300 PPH /
COLUMN WASHING
N1000 / N1300 PPH
908730:
SILANOS SRL



3112536 Colonna
Compact /
PIPE COMPACT
4767:
UNIVER-BAR SRL



3112543 Asse girante
Mix/Top /
ROD MIX/TOP
1018:
UNIVER-BAR SRL



3112527 COLLETTO
RE
LAV.SUP.100/120/140 /
UPPER WASH
COLLECTOR
926036:
ELETTOBAR
DIVISIONE DELLA
EUROTEC SRL



4115747 CONDOTTO
LAVAGGIO SUP.RIVER
/
UPPER WASHING
DUCT FOR.RIVER
*: MBM
RIVER: ELETTOBAR



4115181 SOSTEGNO
GIRANTE 1105 /
ROD SUPPORT 1105
15032910:
RANCILIO SPA



3112400 BRACCIO
LAV-RIS.N1000 /
WASH ARM SUPPORT
MOUNTING POSITION
UPPER N1000
908743:
SILANOS SRL



DIMENSIONS 350mm,
gasket= 2102392

3112356 BRACCIO
LAV-RIS.N1300 /
WASH ARM SUPPORT
N1300
908744:
SILANOS SRL



DIMENSIONS 355mm,
gasket = 2102392

3112493 MOZZO
GIRANTE COMPLETO /
CENTRAL IMPELLER
HUB
12009: ADLER S.P.A.

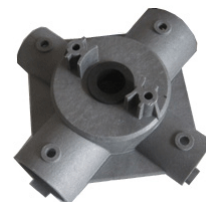

4120111 DISTRIBUT
ORE 2RP DIS.1218 /
CENTRAL BLOCK 2RP
DIS.1218
1955:
ARISTARCO SPA



4115132 DISTRIBUT
ORE 4RP /
WASH ARM CENTRAL
BLOCK 4RP
1954:
ARISTARCO SPA



3112152 TESTA
ROTANTE AL40/45
AL54 /
ROTATING HEAD AL
40/45 AL54
7429: A.T.A. SRL



3112163 CORPO
MULINELLO
RISCIACQUO C34 /
CENTRAL CROSS
RINSE C34-140
191030:
COMENDA ALI SPA
H191030:
HOONVED - ALI SPA



3112328 CORPO
MULINELLO C
POLIPROP. /
ROTATING BODY
WASH C polyprop.
191022:
COMENDA ALI SPA



3112419 CORPO
LAVAGGIO /
RINSE ARMS DRUM
DW75920A:
DIHR-ALI SPA



3114005 GIRELLO 4
VIE /
CENTRAL WASH
CROSS
DW10907:
DIHR-ALI SPA



3112241 GIRANTE
LAVAGGIO /
CENTRAL WASH
CROSS
DW10258:
DIHR-ALI SPA



3112135 GIRANTE
LAVAGGIO 95MM
ALLUNGATA /
LENGTHENED WASH
ROD 95MM
EXDW540013:
DIHR-ALI SPA
DW540043:
DIHR-ALI SPA



3112210 GIRANTE
LAVAGGIO /
CENTRAL WASH
CROSS
DW10376:
DIHR-ALI SPA



4120052 MOZZO PER
GETTI /
ROTATING BODY
049293:
ELECTROLUX
PROFESSIONAL
S.P.A.



4115988 CORPO
RISCIACQUO X5 /
RINSE CROSS X5
80371EX:ELETTROBA
R
*: MBM



3112361 CORPO
PETTINE
RISCIACQUO.X5 /
RINSE CROSS X5
129054:
ELETTROBAR
DIVISIONE DELLA
EUROTEC SRL



3112374 CORPO
LANCIA GIREVOLE DI
RISCIACQUO PER /
RINSE CROSS
DAS265:
COLGED
*: MBM- EUROTEC
SRL
129019: ELETTROBAR



3112597 CORPO
PETTINE RISCIACQUO
STEEL /
COMB STEEL BODY
RINSE
129066:
ELETTROBAR



3112620 CORPO
CENTRALE /
CENTRAL BODY
80609:
ELETTROBAR



3112314 CONDOTTA
CENTRALE PER
LAVABICCHIERI /
CENTRAL COLUMN
FOR GLASSWASHER
*:
MBM- EUROTEC SRL -
DIV. COOKING
SERVICE
115077:
ELETTROBAR



3112316 CONDOTTA CENTRALE 40R / CENTRAL COLUMN FOR GLASSWASHER 40R

115078:

ELETTROBAR

*: MBM- EUROTEC SRL



4120411 CORPETTO COMPLETO X PETTINI PAR.D44 / ROD CENTRAL BODY WASH PAR.D44

129068:

ELETTROBAR



3112046 CORPO LAVAGGIO/RISCIACQUO INF. / LOWER WASHING/RINSING CROSS

46,460, 050F, 050FP, 50FD, 50FELECTRONIC, 500 F, 500FD, E46:

ELETTROBAR

129003:

ELETTROBAR

11F, 11FD, 40F, 40FD, 400F, 400FD, 40FELECTRONIC, E45: ELETTROBAR



3112171 CORPO PETTINE LAV.RISC.EB-E35/40 MN / WASH ARM CENTRE E35/40 MN

129056: ELETTROBAR

DIVISIONE DELLA EUROTEC SRL



3112643 CORPO LANCIA LAVAGGIO/RISCIACQUO / IMPELLER BODY WASH / RINSE

79021:

ELETTROBAR



3112485 COLLETO RE RISC. ROTANTE SQ / CENTRAL COLUMN FOR RINSE ARM

00011164:

ELFRAMO SPA



3112664 COLLETO RE LAVAGGIO ROTANTE LP ASSIEME / WASH COLLECTOR LP

00065336:

ELFRAMO SPA



3112286 CROCIERA PER BRACCIO LAV-RISC. / WASH/RINSE CROSS

CRO001:

FABAR SRL



3125026 BLOCCHETTO A STA LAV-RISC.AP / CENTER BLOCK AP

32360:

HOONVED - ALI SPA



3112513 GRUPPO CENTR.LAV-RISC.AP 60 / CENTRAL BLOCK FOR WASH-RINCE ARM

32281:

HOONVED - ALI SPA



= 3112405

3112295 CROCE BRACCIO LAVAGGIO / CENTRAL CROSS FOR WASH-RINSE ARM

H191027:

HOONVED - ALI SPA

191027:

COMENDA ALI SPA



= 3112153

3112549 TESTINA MULINELLO RISCIAQUO 1206 / RINSE ARM HEAD 1206

0200086:

LAMBER DI AFFABA FRANCESCO & C.



= 3112524

3112211 CROCERA 4 VIE BOCCOLE+VITI / WASH ROD CROSS

L5030: LUXIA SRL



4115719 CROCERA 4
VIE K1300 + VITI /
WASH ARM CENTER
K1300
L5032: LUXIA SRL



3112211 CROCERA 4
VIE BOCCOLE+VITI /
WASH ROD CROSS
L5030: LUXIA SRL



3112333 MOZZO
GIR. CQ GRIGIO (+2
BOCC.) COMP /
WASH ARM CROSS
LSI0607ABGR:
OMNIWASH SRL -



4115043 MOZZO+CO
PERCHIO GIRANTE
RISCIACQUO /
RINSE ARM HUB
904292:
SILANOS SRL



3112447 GIRELLO 2
VIE SOLO PLASTICA
LAVABICCHIERI /
ROTOR HEAD 2 WAYS
2518:
UNIVER-BAR SRL



= 3112487

3112411 GIRELLO 4
VIE SOLO PLASTICA
LAVAPIATTI /
ROTOR HEAD 4 WAYS
3109:
UNIVER-BAR SRL



3112415 GIRELLO 4
VIE SOLO PLASTICA
LAVABICCHIERI /
ROTOR HEAD 4 WAYS
2530:
UNIVER-BAR SRL



4120671 ASS.
COPRITIRANTE SUP.
PASSPORT 1040 /
ASSY COVER ROD
PASSPORT 1040
4925EX:
ARISTARCO KASTEL



OR= 43X3.53mm,
OR= 21X2.62mm

11301:
ARISTARCO KASTEL
SPA

3112636 SUPPORTO
GIRANTE ALP01 GOLA
LATERALE /
SUPPORT FOR ARMY
ASSEMBLY
14274: A.T.A. SRL



3112161 COLONNA
MULINELLO INF. FC /
LOWER WASH ARM
SUPPORT FC-
MACHINES
191068:
COMENDA ALI SPA



3112121 COLONNIN
A X MULINELLO INF.
C75
/ INFERIOR FAN
COLUMN C75
191071:
COMENDA ALI SPA



3112165 COLONNA
MUL.INF.F2-45-55-B15-
9 /
INFERIOR FAN
COLUMN F2-45-55-B15-
9
191025:
COMENDA ALI SPA



3112166 COLONNIN
A INF.FC/Fc /
INFERIOR COLUMN
FC/F?
191064:
COMENDA ALI SPA



3112156 COLONNA
MULINELLO INF.F80-
C70 /
INFERIOR FAN
COLUMN F80-C70
191031:
COMENDA ALI SPA



3112457 SUPPORTO
LAV.CENTRALE SE NE
/
CENTRAL WASH
SUPPORT SE NE
190127:
COMENDA ALI SPA



3112279 COLONNA
INFERIORE PER LF322-
324-325-700 /
COLUMN LOWER
LF322-324-325-700

191102:

COMENDA ALI SPA

36279EX:

HOONVED - ALI SPA



3112582 MOZZO
GIRANTE PLASTICA 05

/
PLASTIC ROTATING
HUB 05

DW500702:

DIHR-ALI SPA

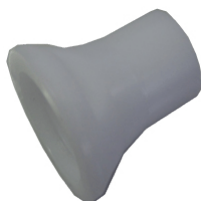

3112468 MOZZO PER
GIRANTE 11 S 09/98 /
NUR FOR IMPELLER
HUB

DW75320:

DIHR-ALI SPA



3112580 TORRETTA
INFERIORE SOSTEGNO
GIRELLO G12 GRIGIA /
IMPELLER SUPPORT
LOWER COLUMN G12
GREY

DW11600035:

DIHR-ALI SPA



3112309 CONDOTTA
CENTRALE TORNITO /
CENTRAL COLUMN

115075:

ELETTROBAR

*: MBM



4115599 SUPPORTO
LANCIA GIREVOLE DI
LAVAGGIO
INFERIORE PER
LAVASTOVI /
WASH ARM HOLDER
50 HEIGHT 126,5mm

DAS2596:

LOTUS SPA

46, 460, 50F, 50FP,

E46, E60, E65, E100,

E110, CLEAN100:

ELETTROBAR



1141250 CONDOTTA
CENTRALE INFERIORE
PER LAVABICC /
LOWER SUPPORTO
FOR GLASSWASHER

115094:

ELETTROBAR

DIVISIONE DELLA

EUROTEC SRL

*:



MBM- EUROTEC SRL -
DIV. COOKING
SERVICE

4115006 COND.CENT
R. CESTO FISSO 11F/FD
/ WASH ARM HOLDER
11F/FD

11F,

11FD:ELETTROBAR



4115888 CONDOTTA
CENTRALE C.FISSO /
INFERIOR CENTRAL
DUCT FOR
GLASSWASHER

REB115089:

LOTUS SPA

115089:ELETTROBAR

*: MBM



4120582 ATTACCO
LANCIA SUPERIORE
COMPLETO /
IMPELLER ATTACK
UPPER COMPLETE

75169:

ELETTROBAR

DIVISIONE DELLA

EUROTEC SRL

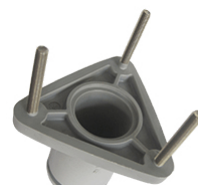

=4120583

4120583 ATTACCO
LANCIA INFERIORE
COMPLETO /
CONNECTION
IMPELLER LOWER
COMPLETE

75171:

ELETTROBAR



=4120582

4115211 CONDOTTO
CENTRALE E.35/40 NM

/
CENTRAL DUCT
E.35/40 NM

E35, E35H, E40,

E40H:

ELETTROBAR



3112317 RACCORDO
LAVAGGIO
INFERIORE ESTERNO /
BELOW WASH
CONNECTION

80179:

ELETTROBAR



3112370 CONDOTTO
CENTR
LAV.INF.DOS.ID X5 /
OPPOSITE SUPPORT

115117:

ELETTROBAR

DIVISIONE DELLA

EUROTEC SRL



3112486 COLLETTA
RE SUP.LAVAGGIO
E.40 /
UPPER WASH
COLLECTOR
111026:
ELETTROBAR



4115887 COLONNA
DODECAGONALE B14 /
DODECAGONAL
COLUMNS B14
00211014:
ELFRAMO SPA



3112497 Z410701000
SOPORTE INFER.
CUADRO COM /
Z410701000 LOWER
SUPPORT
12025133:
FAGOR
INDUSTRIALE S.R.L.



3112081 COLONNA
LAVAGGIO CESTO
FISSO /
WASH ROD FOR FIXED
BASKET
984066000:
GRUPPO CIMBALI
SPA
9191117:
GRUPPO CIMBALI
SPA



DIMENSIONS 110mm

3112234 ASSIEME
COLONNA LAVAGGIO
NP 43-49 /
WASH COLUMN NP 43-
49
984756000:
GRUPPO CIMBALI
SPA
9121003EX:
GRUPPO CIMBALI
SPA



dado=1141107,
gasket=2102193

3112238 GRUPPO
LAV. RISC.INF.NAP /
LOWER WASH
ROD.NAP
9131278:
GRUPPO CIMBALI
SPA
986519000:
GRUPPO CIMBALI
SPA



4115510 GRUPPO
CENTR. LAV-RISC. AP /
HOLDER AP
32350:
HOONVED - ALI SPA



gasket= 2101413

4115259 COLONNIN
A INFERIORE X BHC /
WASH ARM HOLDER
LOWER
H191083:
HOONVED - ALI SPA
191083:
COMENDA ALI SPA



3112573 PROLUNGA
COLONNINA
LAVAGGIO
INFERIORE /
EXTENSION COLUMN
LOWER WASH
37613:
HOONVED - ALI SPA



3112579 BRACCIO
CURVO A 1 GETTO
FILET. /
ARM ELBOW 1 JET
NUT
29358:
HOONVED - ALI SPA



3112618 CORPO
FISSO PLASTICA /
FIXED BODY PLASTIC
104401:
KRUPPS S.R.L.

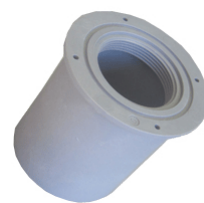

3112621 COLONNA
LAVAGGIO /
COLUMN WASHING
0201452:
LAMBER DI AFFABA
FRANCESCO & C.



THREAD= 1" 1/4

3112423 TORRETTA
PLASTICA
LAVAGGIO/RISCIACQ
UO LAVABICCHIERI /
LOWER REVOLVER
SUPPORT
DW10205B*:
DIHR-ALI SPA
1570:
UNIVER-BAR SRL



3112424 TORRETTA
INFERIORE
LAVAGGIO/RISCIACQ
UO COSMO/COMPACT
/
LOWER REVOLVER
SUPPORT
COSMO/COMPACT
4731:
UNIVER-BAR SRL



4120244 DISTRIBUTORE INFERIORE / LOWER WASH SUPPORT
33M1670: ANGELO PO
DW500621:
DIHR-ALI SPA



4115605 CONCHIGLIA A NYLON / WASH ARM HOLDER NYLON
1695:
ARISTARCO SPA



4115630 CONCHIGLIA INFERIORE / BELOW WASHING ARM SUPPORT
2149:
ARISTARCO SPA



4120007 CONCHIGLIA SUPERIORE / UPPER SHELL
3515:
ARISTARCO SPA



4120331 CONCHIGLIA SUPERIORE PLASTICA / UPPER SHELL
2150:
ARISTARCO SPA



4120698 ASSIEMA TIRANTE INFERIORE AP 35.21 - AE 35/38/40 M13x1 / LOWER ROD ASSEMBLY AP 35.21 - AE 35/38/40 M13x1
10786:
ARISTARCO KASTEL SPA



3112123 RACCORDO ASPIRAZIONE / SUCTION JOINT
2373:
ARISTARCO SPA

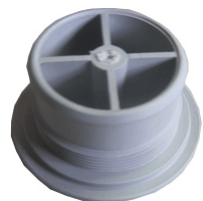

3112592 SUPPORTO GIRANTE AT/ALP44 / ROTATING STAND AT/ALP44
9601: A.T.A. SRL



4120545 PIANTONE GIRELLO STAMPATO / LOWER SUPPORT
6841: A.T.A. SRL



4115687 COLONNA SUPERIORE / UPPER COLUMN
AF61: A.T.A. SRL



1140064 PIANTONE SUPERIORE / LOWER SUPPORT
4375: A.T.A. SRL



1140066 SOTTOPIANTONE AL45 / WASH ARM HOLDER LOWER
6880: A.T.A. SRL



gasket=2102191

1140071 PIANTONE SUPERIORE AL 40/45 / UPPER SUPPORT AL40/45
6804: A.T.A. SRL



1140075 PIANTONE TESTA ROTANTE / WASH ARM HOLDER
7100: A.T.A. SRL



1140153 SOTTOPIANTONE AL 41/46 E / WASH ARM HOLDER LOWER AL 41/46 E
6806: A.T.A. SRL



1141312 SOTTOPIANTONE /
OPPOSITE SUPPORT
FOR WASH ARM
SUPPORT
4369: A.T.A. SRL



1140155 PIANTONE
AL55 /
WASH ARM SUPPORT
AL55
AL55: A.T.A. SRL

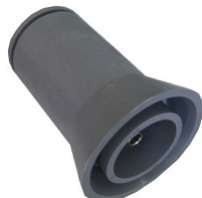

1140128 PIANTONE
AL 40-45 NT /
ROD SUPPORT AL 40-
45 NT
6801: A.T.A. SRL



1140144 PIANTONE
AL 54 /
CONNECTION FOR
LEVEL
REGULATORHOSE
6802: A.T.A. SRL



3112353 ATTACCO
INFERIORE GIRANTE
DI RISCACQUO AF AL
/
LOWER RINSE ARM
CONNECTION AF AL
4353: A.T.A. SRL



3112157 COLONNA
MUL.INF. C95-C155-
C165 /
INFERIOR FAN
COLUMN C95-C155-
C165
191059:
COMENDA ALI SPA

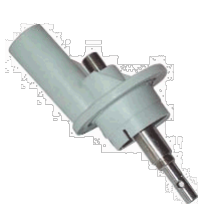

4115261 PIPA X
MULINELLO SUP.C.75 /
UPPER WASH ARM
SUPPORT C75
190216:
COMENDA ALI SPA

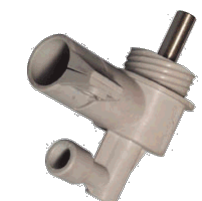

4115520 PIPA
SUP.MUL.F2-45-55-65-
80 /
UPPER PIPE F2-45-55-
65-80
190205:
COMENDA ALI SPA



4115453 PIPA PER
MULINELLO
RISCACQUO C34 /
UPPER WASH-RIN
ARM SUPPORT C30-70
190206:
COMENDA ALI SPA



4120423 PIPA
INFERIORE F 2011-
LC411.. /
PIPE LOWER F 2011 -
LC411
F 2011- LC411:
COMENDA ALI SPA



3124119 PIPA
SUPP.MULINELLO
C/LC 2001 /
ARM SUPPORT PIPE
C/LC 2001
190227:
COMENDA ALI SPA
H190227:
HOONVED - ALI SPA



4115625 PIPA
SUPERIORE
MULINELLO FC /
WASH ARM HOLDER
UPPER
190215:
COMENDA ALI SPA



4115476 PIPA
INFERIORE
LAVAGGIO /ACL BT-
BC-FC43 /
PIPE LOWER WASH /
ACL BT-BC-FC43
190210:
COMENDA ALI SPA



3112469 COLONNIN
A FC2006 /
COLUMN FC2006
190233:
COMENDA ALI SPA



3124119 PIPA
SUPP.MULINELLO
C/LC 2001 /
ARM SUPPORT PIPE
C/LC 2001
190227:
COMENDA ALI SPA
190227:
HOONVED - ALI SPA



3112547 STAMPATO
DISTRIB. LAV.R /
MOULDED WASH R
DISTRIBUTOR
DW15069D:
DIHR-ALI SPA



4115383 SEMIL.TOR
RETTA SUP.P646 LS
GIR. T.4 /
TOP TURRET FOR
ROTOR P646
DW540047:



DIHR-ALI SPA

4115377 SEMIL.TOR
RETTA INF. P646
GIRANTE T.4 /
LOWER TURRET. P646
IMPELLER T.4
DW540046ex:
DIHR-ALI SPA



3112516 TORRETTA
INFERIORE /
LOWER TURRET
DW90008:
DIHR-ALI SPA



3112517 MOZZO
FISSAGGIO TORRETTA
/
HUB FOR TURRET
DW90009:
DIHR-ALI SPA



3112532 GRUPPO
LAVAGGIO
INFERIORE /
LOWER WASH
SUPPORT
DW25005:
DIHR-ALI SPA



4115370 STAMPATO
TORR.LAVAGGIO INF.
/
WASH ARM HOLDER
LOWER
DW10205C:
DIHR-ALI SPA



4115822 STAMPATO
TORRETTA
INF.LAVAGGIO GRIG /
BELOW WASH ARM
HOLDER
DW10205B:
DIHR-ALI SPA



4115242 ASSIEME
DISTR.LAV.RISC.SUP
P646 /
WASH ARM HOLDER
P646
DW15069/D:
DIHR-ALI SPA



4115380 TORRETTA
SUP.RISCIACQUO /
RINSE LOWER
TURRET
DW10909:
DIHR-ALI SPA



3112532 GRUPPO
LAVAGGIO
INFERIORE /
LOWER WASH
SUPPORT
DW25005:
DIHR-ALI SPA



4115401 POZZETTO
CON SCARICO
LATERALE DX DIHR /
INLET VALVE / DRAIN
VALVE
DW500606:
DIHR-ALI SPA



4115399 GHIERA
CON INNESTO FILTRO
MOD 50 /
NUT WITH
CONNECTION FOR
FILTER MOD 50
DW500615:
DIHR-ALI SPA



4120424 SUPPORTO
FILTRO /
FILTER SUPPORT
DW25002:
DIHR-ALI SPA

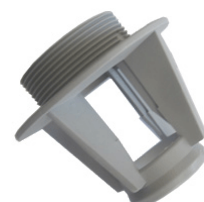

4115707 CORPO
D'ASPIRAZIONE/SCARI
CO GRIGIO SCURO /
ASPIRATION/LOT
BODY DARK GREY
136020:
ELETTOBAR
DIVISIONE DELLA
EUROTEC SRL



3101030 SUPPORTO
GETTI SUP. 046368 /
WASH ARM HOLDER
UPPER 046368
046368ex:
ELECTROLUX



4120172 "COLLETTA
RE DI SCARICO; KIT" /
DRAIN COLLECTOR
KIT
0L1629:
ELECTROLUX



4115540 SUPPORTO
LANCIA GIREVOLE DI
LAVAGGIO /
WASHING ARM RIN
SUPPORT
926153:
ELETTROBAR



3112245 CONDOTTA
CENTRALE PER
LAVABICCHIERI /
WASH ARM HOLDER
40F, 40FD, 400F,
400FD, 40F
ELECTRONIC:
ELETTROBAR



4115154 COLLETTA
RE INFERIORE NERO
ACQUA 50 /
LOWER COLLECTOR
ACQUA 50
111999: ELETTROBAR



4115907 SUPPORTO
INFERIORE ESTERNO
PER LANCIA /
LOWER SUPPORT FOR
ARM RIN
*: MBM
926052:
ELETTROBAR



4120645 PIANTONE
CENTRALE
SUPERIORE /
COLUMN CENTRAL
UPPER
115149:
ELETTROBAR
DIVISIONE DELLA
EUROTEC SRL



4115005 COLLETTA
RE INF. ACQUA C/F11 /
COLLECTOR LOWER
WATER C/F11
111009: ELETTROBAR



3112449 GR.COLLETTA
TORE INF.NEUTRO
E50NM+2TAPPI /
BOTTOM OPPOSITE
SUPPORT FOR WASH
ARM SUPPORT
111030:
ELETTROBAR
111013:
ELETTROBAR
111998: ELETTROBAR
*: MBM
*: MBM



4120132 CORPO
ASPIR./SCARICO LA50
/
DRAIN SUCTION
BODY LA50
136028:
ELETTROBAR



4120552 CORPO
ASPIRAZIONE /
SCARICO LA500 /
BODY INTAKE /
DRAIN LA500
136030:
ELETTROBAR



4120201 RACCORDO
LAV.SUP.EST.GOLD
(COL.NEUTRO) /
WASH JOINT FOR
GOLD
80174:
ELETTROBAR



4120432 CONDOTTO
CENTRALE SUPER
CPL. E55 /
WASH ARM SUPPORT
POS. UPPER E55
115129:
ELETTROBAR



3112657 COLLETTA
RE /
COLLECTOR
115116:
ELETTROBAR
DIVISIONE DELLA
EUROTEC SRL



4115730 RACCORDO
LANCIA DI LAVAGGIO
INFERIORE PER
LAVEPENTOLE
COMPLE /
FITTING FOR LOWER
WASH LANCE POT
WASHER COMPLETE

*: **MBM**

C42063:

ELETTROBAR



3112420 CONDOTTA
CENTRALE INFERIORE
66 / BELOW WASH
ARM SUPPORT

115041:

ELETTROBAR

*:

**MBM- EUROTEC SRL -
DIV. COOKING
SERVICE
COLGED**



3112647 COLONNA
DODECAGONALE
D80F /
SUPPORT FOR ARM
ASSEMBLY

00014064:

ELFRAMO SPA



L=173mm

4115727 GHIERA
SCARICO /
NUT FOR DRAIN
SECTION

429067:

ELETTROBAR

*: **MBM**



4115484 GRUPPO
INFERIORE PER
LAVABICCHIERI /
INTAKE BODY

**E35, E35H, E40,
E40H:**

**ELETTROBAR
DIVISIONE DELLA
EUROTEC SRL**



4115874 COLLETO
RE INF. BD14 FLANG.
FIL. /
WASH ARM HOLDER
LOWER

BD13, BD14:

ELFRAMO SPA



4115183 COLLETO
RE FISSO 1" 1/2
INFERIORE ELFRAMO
C44/66 /
LOWER COLLECTOR
FIXED 1" 1/2 ELFRAMO
C44/66

00018063:

ELFRAMO SPA



4115184 COLLETO
RE FISSO SUPERIORE
1"1/2 ELFRAMO C44/66
/

**COLLECTOR FIXED
1"1/2 ELFRAM C44/C66**

00018062:

ELFRAMO SPA



4115469 COLLETO
RE INFERIORE D40 /
INFERIOR
COLLECTOR D40

00012710:

ELFRAMO SPA



4115245 TORRETTA
INF.LAV./DISTR.) /
WASH ARM HOLDER
LOWER

30970:

**GRUPPO CIMBALI
SPA**



4115262 SUPP.MULI
N.SUP.C.LAV.C110
COMENDA /
WASH ARM HOLDER
UPPER

510503:

COMENDA ALI SPA



4115451 SUPP.MULI
NF. "C" LAV-L C110 /
"INFERIOR
WHIRLPOLL SUPPORT
"C" LAV-L C110"

33471:

HOONVED - ALI SPA

510238:

COMENDA ALI SPA



4120407 LOWER
WASHARM GUIDE /
LOWER WASHARM
GUIDE

8981941:

HOBART GmbH



4120604 COLLETO
RE LAVAGGIO
SUPERIORE CON
ALBERO /
SUPPORT FOR UPPER
WASH ARM ASSEMB.
WITH PIN

172695:

HOBART GmbH



3112197 SUPP.MUL.I
NF."C"LAV-L C110-140
/
UPPER SUPPORT FOR
WASH ARM C110-140
33470:
HOONVED - ALI SPA



4115260 PIPA
INFERIORE
LAVAGGIO
RISCIACQUO BHC /
PIPE LOWER WASH
RINSE BHC
H190223:
HOONVED - ALI SPA
190223:
COMENDA ALI SPA



4120495 SUPPORTO
MULINELLO SUP.C 43-
48 /
SUPPORT ARM
ROTATING WASH /
RINSE SUP.C 43-48
34316: HOONVED



4115432 SUPPORTO
MULIN. SUP. B15-BC ç /
"
UPPER WASH/RINSE
ARM SUPPORT
""BTM""
H190209: HOONVED
190209: COMENDA



3112294 SUPPORTO
MULINELLO SUP. C-
STS /
WASH ARM HOLDER
34314:
HOONVED - ALI SPA



4120158 PIPA
SUPERIORE AP/E /
UPPER SUPPORT AP/E
*:
COMENDA ALI SPA
H190231ex:
HOONVED - ALI SPA



3112628 COLONNIN
A X SUPPORTO
PLASTICA CAP7E11 /
COLUMN X SUPPORT
PLASTIC CAP7E11
191127:HOONVED



3112572 COLONNIN
A SUPERIORE
/INFERIORE AP E /
COLUMN UPPER /
LOWER AND AP
37611:
HOONVED - ALI SPA



3112631 GRUPPO
INOX LAVAGGIO 1250
/
CENTRAL CONDUCT
1250140:
KRUPPS S.R.L.



3112397 CORPO
FISSO CENTRALE Ø60
MM /
HOUSING - FIXED
CENTRAL Ø60 MM
104140:
KRUPPS S.R.L.



3112379 CORPO
FISSO CENTRALE Ø50
MM /
CENTRAL PIN 250 MM
104125k:
KRUPPS S.R.L.
104120:
KRUPPS S.R.L.



3112663 GRUPPO
LAVAGGIO INOX 800-
810 /
WASH ARM INOX 800-
810
850140ex:
KRUPPS S.R.L.
850140K:
KRUPPS S.R.L.



4120270 GRUPPO
PLASTICA PERNO
CORTO TAPPO /
GROUP SHORT PIN
PLASTIC CAP
104411:
KRUPPS S.R.L.



3112642 COLONNIN
A 031 /
WASH BOSS
EXTENSION 1"1/4
0200126:
LAMBER SRL



3112360 SUPPORTO
INF. MOD. K1300 /
WASH ARM SUPPORT
MOUNTING POSITION
UPPER/LOWER
MOD.K1300
L3366: LUXIA SRL



3112530 ASSMANDA
TA SUPERIORE /
UPPER SUPPORT
41206700:
MODULAR SPA



3112478 COLLETT
RE /
COLLECTOR
45102500:
MODULAR SPA

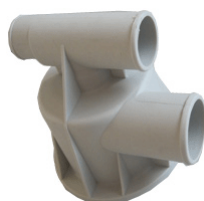

4115649 SUPPORTO
MOZZO INF.CQ 1-2
J/CSL+PR BIANCO
COMP /
COMPLETE HOLDER
CQ 1-2/J/CSL+PR
LI029CBJB:
OMNIWASH SRL -



4115603 SUPPORTO
MOZZO SUP.CQ 1-2-
4/82 BIANCO /
WHITE WASH ARM
HOLDER FOR CQ 1-2-
4/82
LS5BGR:
OMNIWASH SRL



1141178 SUPPORTO
MOZZO SUP. CQ 62P
BIANCO COMP /
UPPER SUPPORT CQ
62P WHITE
L56012BGR:
OMNIWASH SRL -
SOCIETA' A SOCIO
UNICO



4115679 SUPPORTO
MOZZO INF.CQ 4-6+PR
BIANCO COMP /
WASH ARM HOLDER
INF.
LI029CABGR:
OMNIWASH SRL -
SOCIETA' A SOCIO
UNICO



4120076 SUPPORTO
MOZZO SUP.CQ
62P+PERNO BIANCO
COMP /
SUPPORTO MOZZO
SUP.CQ 62P+PERNO
BIANCO COMP



4115315 PIPA
MANDATA LAVAGGIO
/
WASHING PIPE
38123202:
RANCILIO SPA



3112129 TUBO
GIRANTE LAVAGGIO
LT 105 /
WASH ARM LT 105
30005005:
RANCILIO SPA



4115089 MOZZO
SUP.LAV/RISC. P-C-B-
A-GR /
UPPER WASH ARM
HUB P-C-B-A-GR
900033:
SILANOS SRL



= 2102113

4120124 RACC.
LAV./RISC. SUP. N1000
V.T. /
UPPER WASH ARM
SUPPORT
908700:
SILANOS SRL



4115204 MOZZO
INFERIORE D. 13 /
BELOW HUB D.13
904290:
SILANOS SRL



4115804 MOZZO INF.
LAV. N1300 /
OPPOSITE SUPPORT
MOUNTING POS.
BOTTOM FOR WASH
ARM SUPPORT
900049:
SILANOS SRL



4115494 POZZETTO
ASPIRAZIONE
N45/N50/N90 /
WASH RINSE
DISTRIBUTOR
N45/N50/N90
905255:
SILANOS SRL



4120554 POZZETTO

ASPIRAZIONE
N45/N50/N90/E50/N650/
N750 905245 /
COCKPIT INTAKE N45
/ N50 / N90 / E50 / N650 /
N750 905 245

905245:

SILANOS SRL



4115230 MOZZO

LAV/RISC INF.PCBAG-
8-9-10-V-EC /
WASHING/RINSING
BELOW HUB PCBAG-8-
9-10-V-EC

F27: SILANOS SRL



4115920 MOZZO

INF.LAV/RISC N45-
N50+GHIERA /
WASH/RINSE ARM
HUB N45-N50

905557:

SILANOS SRL



3112588 MOZZO

INFERIORE
LAVAGGIO
/RISCIACQUO N19-
N22-N27+GHIERA /
HUB LOWER WASH /
RINSE N19-N22-N27 +
RING

905555:

SILANOS SRL



1140055 PERNO

LAVAGGIO
RISCIACQUO INF.600-
700 SILANOS /
LOWER RINSE ARM
SUPPORT 600-700
SILANOS

905556: SILANOS

SRL

900032ex:

SILANOS SRL



1140145 MOZZO

LAV. SUP. SX
N45/50/N1000 / UPPER
HUB SX N45/50/N1000

905449: SILANOS

SRL



gasket=2102356

1140152 MOZZO

LAVAGGIO
INFERIORE DX
N45/N50/N700/N1000 /
LOWER WASH ARM
ASSEMBLY SUPPORT

905456:

SILANOS SRL

33M0130:

ANGELO PO GRANDI



GASKET=2102356

CUCINE SPA

3112488 DISTRIBUT

ORE LAV.RISC.
AVVITATO Ø 25 + Ø 16
TUTTO APERTO /
WASH-RINSE ARM
SUPPORTO

20070B:

SISTEMA PROJECT



3112422 TORRETTA

RISCIACQUO
SUPERIORE /
UPPER REVOLVER
SUPPORT
MIX/MIXD/BET37

2522:

UNIVER-BAR SRL



4120122 DISTRIBUT

ORE SUPERIORE
COMPLETO COSMO /
COMPLETE SUPPORT
COSMO

4632:

UNIVER-BAR SRL



4120058 BICCHIERE

CON ALBERO /
COVER WITH PADDLE

3340:

UNIVER-BAR SRL



4120087 BICCHIERE

CON ALBERO SINCRO
/
COVER WITH PADDLE
SINCRO

3721:

UNIVER-BAR SRL



3112526 GRUPPO

LAVAGGIO
RISCIACQUO
COMPACT /
WASH-RINSE ARM
SUPPORT COMPACT

4730: UNIVER-BAR



3112409 TORRETTA

INFERIORE
LAVAGGIO/RISCIACQ
UO
MIDI50/LOGOS/OMEG
A /
WASH/RINSE ARM
MIDI50/LOGOS/OMEG
A

3310: UNIVER-BAR



1140242 ASSIEME
TIRANTE INFERIORE.
A35 /
LOWER ROD
ASSEMBLY A35
5312:
**ARISTARCO KASTEL
SPA**



3112410 GRUPPO
SUPERIORE
LAVAGGIO/RISC.
MIDI40/SINCRO/MIDI5
0/LOGOS/O /
WASH/RINSE ARM
HOLDER
MIDI40/SINCRO/MIDI5
0/LOGOS/O
3343:
UNIVER-BAR SRL



4120082 ELEMENTO
TORRETTA
BET37/BET40/ERGON/
MIDI40 /
HOLDER FOR
BET37/NET40/ERGON
MIDI40
1541:
UNIVER-BAR SRL



3112452 GRUPPO
LAVAGGIO/RISCIACQ
UO
INF.COMPL.MIDI50/LO
GOS/OMEGA /
WASH ARM CENTRE
MIDI50/LOGOS/OMEG
A
3336:
UNIVER-BAR SRL



3112416 TORRETTA
INFERIORE
LAVAGGIO/RISCIACQ
UO SINCRO /
LOWER WASH RINSE
TURRET SINCRO
3742:
UNIVER-BAR SRL



3112479 GRUPPO
LAVAGGIO/RISCIACQ
UO COMPLETO
MIX/TOP /
WASH RINSE SUPPORT
COMPLETE MIX-TOP
3273:
UNIVER-BAR SRL



3112603 Torretta
inferiore
lavaggio/risciacquo
completa Cosmo/Compac
/
Lower turret washing /
rinsing complete Cosmo /
Compac
4745:
UNIVER-BAR SRL



4115813 KIT
SUPPORTO
ROTAZIONE BRACCIO
WINTERHALTER /
ARM HOLDER KIT
WINTERHALTER
61006065:
**WINTERHALTER
ITALIA SRL**

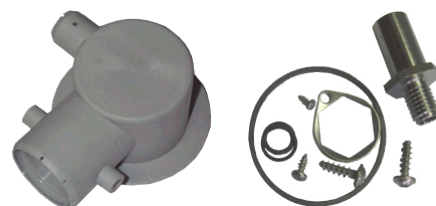

3112541 DIRAMAZIO
NE INFERIORE /
WASH DISTRIBUTOR
3501018:
**WINTERHALTER
ITALIA SRL**



3112173 FLANGIA
CON INNESTO AC/ACR
*/ç /
FLANGE WITH
COUPLING AC / ACR *
/ ç.
180232:
COMENDA ALI SPA



3112282 TURBO
GRANDE
PREM.ED700.900/90 /
WASH ARM HOLDER
ED700.900/90
21540:
HOONVED - ALI SPA



4120603 MOZZO
ASSEMBLATO /
HUB-ASSEMBLY
119222M:
HOBART GmbH



3112596 "ASSIEME
COLLETTORE
LAVAGGIO; C.S.ONE
061" /
WASH MANIFOLD
ASSEMBLY; C.S.ONE
061"
0C6202:
ELECTROLUX



3112312 MOVIMENT
O GIRELLO 11R/RD /
ROTATING ROD
11R/RD
11R/RD:
**ELETTOBAR
DIVISIONE DELLA
EUROTEC SRL**



3101186 GETTO GIRANTE RISCIAQUO / RINSE JET
12014: **ADLER S.P.A.**



3101185 DEFLETTOR E GETTO RISCIAQUO / SWIRL
12015: **ADLER S.P.A.**



3101197 GHIERA NYLON / RING NUT NYLON
11998: **ADLER S.P.A.**
OHA082:
ELECTROLUX PROFESSIONAL S.P.A.

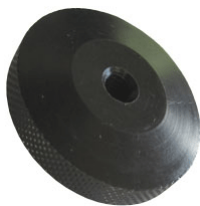

3101015 UGELLO RISCIAQUO A LAMA NERO / BLACK BLADE RINSING JET
AL, AF, AT: **A.T.A. SRL**
6831: **A.T.A. SRL**



3101019 TAPPO D. 12 ATA 4649 / CAP D.12 ATA 4649
AL,AF,AT: **A.T.A. SRL**



3101014 UGELLO RISCIAQUO ATA 1001 / RINSING JET ATA 1001
AL, AF, AT: **A.T.A. SRL**

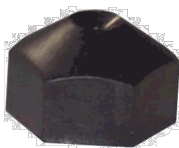

3101007 GHIERA X UGELLO RISCIAQUO A LAMA / RINSING JET BLADE METAL RING
6832: **A.T.A. SRL**
AL, AF, AT: **A.T.A. SRL**



3101016 PORTAUGELLO RISCIAQUO NERO / BLACK RINSING JET-HOLDER
6830: **A.T.A. SRL**
AL, AF, AT: **A.T.A. SRL**



3101017 PORTAUGELLO RISCIAQUO ATA / RINSING JET-HOLDER ATA
AL, AF, AT: **A.T.A. SRL**



3101084 UGELLO RISC. A FASCETTA COMENDA / RINSING JET COMENDA
170963: **COMENDA**
34264ex: **HOONVED**
170963: **HOONVED**



3101027 UGELLO RISCIAQUO MUL. F45/55 / RINSING JET F45/55
170946:
COMENDA ALI SPA
33791ex:
HOONVED - ALI SPA
170946:
HOONVED - ALI SPA



3101022 GETTO RISCIAQUO COMENDA / RINSING JET B23 F2 C34
170911:
COMENDA ALI SPA
170911:
HOONVED - ALI SPA



3101023 STAFFA GETTO RISCIAQUO F B C33 / RINSING JET BRACKET F B C33
170704:
COMENDA ALI SPA
H170704:
HOONVED - ALI SPA

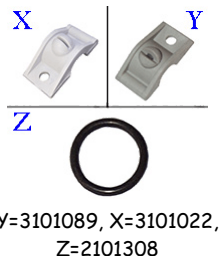

3101087 GETTO AQ MORSETTO DX USA / RIGHT JET USA
170923:
COMENDA ALI SPA



3101089 UGELLO
RISCIACQUO USA /
RINSE NOZZLE USA
170941:
COMENDA ALI SPA



X



Y



X= 3101023, Y= 2101308

3101132 UGELLO
CIECO MULINELLO F2
/
BLIND JET F2-C-GRAY
170930:
COMENDA ALI SPA
H170930:
HOONVED - ALI SPA



3101133 UGELLO
RISCIACQUO
MULINELLO F 2 /
RINSING JET F2-C-
GRAY
170929:
COMENDA ALI SPA
H170929:
HOONVED - ALI SPA



3101115 UGELLO
MULIN.RISC.INOX FC /
RINSING JET FOR
FC53-543
170958:
COMENDA ALI SPA



= 2101378

3101097 UGELLO
PIANO D. 28 APERTO
DIHR /
OPENED PLANE JET
D.28 DIHR
DW10219EX:
DIHR-ALI SPA
DW10268:
DIHR-ALI SPA
DW10218:
DIHR-ALI SPA



3101094 UGELLO
RISCIACQUO D10
COMPLETO /
COMPLETE RINSING
JET D10
DW12528:
DIHR-ALI SPA



3101095 UGELLO
PIANO D. 10 APERTO
DIHR /
OPENED PLATE JET D.
10 DIHR
DW10263: DIHR-ALI
EXDW10213: DIHR-
ALI



3101195 UGELLO
RISCIACQUO
COMPLETO O10 (MIN /
RINSE NOZZLE
COMPLETE O10
DW10262:
DIHR-ALI SPA



3101096 UGELLO
PIANO D. 10 CHIUSO
DIHR /
JET D.10 DIHR
DW10217ex:
DIHR-ALI SPA
DW10267: DIHR-ALI



3101082 GETTO
RISCIACQUO DIHR /
RINSING JET DIHR
DW10371:
DIHR-ALI SPA
DW12537ex:
DIHR-ALI SPA



3101140 UGELLO
DIHR /
JET DIHR
DW10378:
DIHR-ALI SPA



3101152 TESTA
UGELLO RISC. 95
CHIUSO GRIGIO /
BLIND NOZZLE
SMALL
DW10372:
DIHR-ALI SPA
DW12538: DIHR-ALI



3101102 UGELLI
CON SPACCO ORIZ.
P646 /
HORIZONTAL FISSURE
JETS P646
DW10746:
DIHR-ALI SPA
DW10264: DIHR-ALI



3101103 UGELLI
CON SPACCO
STRETTO P646 /
NARROW FISSURE
JETS P646
DW10746Aex:
DIHR-ALI SPA
DW10221: DIHR-ALI



3101104 UGELLI
PIANO D18 APERTO
P646 /
OPENED PLANE JETS
D18 P646
*: DIHR-ALI SPA
DW10266: DIHR-ALI



3101105 UGELLI
PIANO D18 CHIUSO
P646 /
CLOSED PLANE JETS
D18 P646

DW10216:

DIHR-ALI SPA

DW10265: DIHR-ALI



3101078 GHIERA
RISCIACQUO /
RINSING METAL RING
45, 450, 46, 460, 50F,
50FP,
50FD,50ELECTRONI
C,500F, 500FD:

ELETTROBAR



3101067 GETTO
RISCIACQUO S621-3-31
/

RINSING JET S621-3-31
S621, S623, S624,
S626, S631, S634,
S636, 21F, 21FD, 31F:

ELETTROBAR

50F, 50FD, 50FP,
50ELECTRONIC,500
F,500FD, E35, E35H:

ELETTROBAR

S651, S653, S654,
S655, S830, S835,
S850, 11F, 11FD, E45:

ELETTROBAR

40FD, 400F, 400FD,
400F ELECTRONIC,
E40, E40H, E41, E42:

ELETTROBAR

E50, E51, E52, E60,
E100, E110, E120,
CLEAN100,12,10,66:

ELETTROBAR

31FD, 25F, 25FD, 30F,
30FD, 45, 450, 46,
460, 22F, 40F,

E46:ELETTROBAR



= 3101068

3101068 GHIERA
RISCIACQUO S621-3-31
/

RINSING JET RING
S621-3-31

40FD, 400F, 400FD,
40F

ELECTRONIC,E41,E42
, E45: ELETTROBAR

S621,S623, S624,
S626, S631, S634,
S636, 22F, 40F, E46:

ELETTROBAR

E51, E50,E60, E100,
E110, E120,
CLEAN100, 10, 12,

66:ELETTROBAR

21F, 21FD, 31F, 31FD,
25F, 25FD, 30F, 30FD,
E35,E35H:



= 3101067

ELETTROBAR

S651, S653, S654,
S655, S830, S835,
S850, 11F,
11FD:ELETTROBAR

3101069 MOLLA
FISSAGGIO COLLARE
S810 /

COLLAR SPRING

S651, S654, S810,
S815, S830, S835,
22F, 40F, E50, E51,
E52:

ELETTROBAR

E60, E100, E110,
E120,, CLEAN100, 10,
12, 66:

ELETTROBAR



3101158 SPRUZZATO
RE RISCIACQUO IN
PLASTICA CSP2502 /
NOZZLE

*: MBM- EUROTEC
SRL - DIV. COOKING
SERVICE

926133:

ELETTROBAR

*: MBM- EUROTEC
SRL - DIV. COOKING
SERVICE

CSP2502: LOTUS SPA
CSP2502: COLGED



3101073 ANIMA
UGELLO RISCIACQUO
/

RINSING JET CORE
00011176:

ELFRAMO SPA

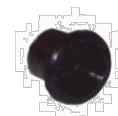

3101046 UGELLI
RISCIACQUO SQ120
ELFRAMO /

RINSING JET SQ120
ELFRAMO

00011175:

ELFRAMO SPA



3101193 UGELLO
RISCIACQUO E
ASSIEME /

RINSE NOZZLE
00004960:

ELFRAMO SPA



3101047 GETTO
RISCIACQUO /
RINSING JET

984220000:
GRUPPO CIMBALI
SPA
9021018:
GRUPPO CIMBALI
SPA



= 3101048

3101048 DIFFUSORE
GETTO RISCIACQUO /
RINSING JET
DIFFUSER

984219000:
GRUPPO CIMBALI
SPA
9021017:
GRUPPO CIMBALI
SPA

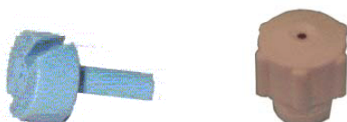

= 3101047

3101200 RINSE JET /
RINSE JET

2268003:
HOBART GmbH



3101051 GETTO
RISCIACQUO 2,5
PREM. /
RINSING JET 2,5 PREM.

21021:
HOONVED - ALI SPA



= 3101064

3101063 GETTO
RISCIACQUO O 1,5
PREM. /
RINSING JET O 1,5
PREM.

22155:
HOONVED - ALI SPA



= 3101064

3101064 NIPLES
GETTI RISCIACQUO /
NIPLES RINSING JETS

31314:
HOONVED - ALI SPA

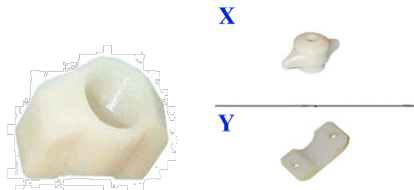

X= 3101063, Y= 3101080

3101080 FASCETTA
NIPPLES RISCIACQUO
/

RINSING NIPPLES
BAND
31313:
HOONVED - ALI SPA



3101079 GETTO
RISCIACQUO NERO /
BLACK RINSING JET

APS48:
HOONVED - ALI SPA



3101178 GETTO
RISCIACQUO O 1 /
RINSE SPRAY O 1

31383:
HOONVED - ALI SPA



3101138 UGELLO
RISCIACQUO CQ
COMPLETO /
COMPLETE RINSING
JET CQ

L3325: LUXIA SRL



3101190 GETTO DI
RISCIACQUO MEIKO /
RINSE JET MEIKO

9517406: MEIKO



3101009 GETTO
RISCIACQUO IME CQ /
RINSING JET SQUARE
BASKET IME

LSI020BGR:
OMNIWASH SRL -
SOCIETA' A SOCIO
UNICO



= 3101010

3101010 GHIERA
PER GETTO
RISCIACQUO CQ IME /
RINSING JET RING
SQUARE BASKET IME

LSI021BGR:
OMNIWASH SRL -
SOCIETA' A SOCIO
UNICO



= 3101009

3101002 GETTO
RISCIACQUO IME /
RINSING JET IME

GRO20BGR:
OMNIWASH SRL -
SOCIETA' A SOCIO
UNICO
GRO20:
OMNIWASH SRL -
SOCIETA' A SOCIO
UNICO

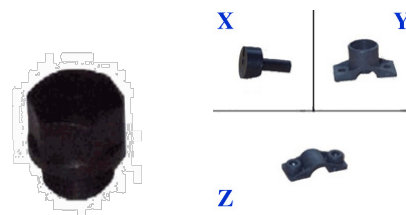

X= 3101003, Y=3101004,
Z= 3101005

3101003 ROMPIGETT
O RISCIAQUO CT IME
/
RINSING STOP JET
ROUND BASKET IME

GR021:

OMNIWASH SRL -
SOCIETA' A SOCIO
UNICO

GR021BGR:

OMNIWASH SRL -
SOCIETA' A SOCIO
UNICO



Z
X= 3101002, Y=3101004,
Z= 3101005

3101025 GETTO
RISCIAQUO CILIN.
SILANOS /
CYLINDRICAL
RINSING JET SILANOS
908090: SILANOS
SRL



= 3101026

3101004 SUPPORTO
SUPER. GETTO
RISCIAQUO CT /
RINSING JET UPPER
REST ROUND BASKET
IME

GR019BBGR:

OMNIWASH SRL -
SOCIETA' A SOCIO
UNICO



Z
X= 3101002, Y=3101003,
Z= 3101005

3101026 ROMPIGETT
O RISCIAQUO
SILANOS /
RINSING STOP JET
ROUND BASKET
SILANOS
908080: SILANOS
SRL



= 3101025

3101005 SUPPORTO
INF. GETTO
RISCIAQUO CT /
RINSING JET INFERIOR
REST ROUND BASKET
IME

GR019D:

OMNIWASH SRL -
SOCIETA' A SOCIO
UNICO

GR019DBGR:

OMNIWASH SRL -
SOCIETA' A SOCIO
UNICO



Z
X= 3101002, Y=3101003,
Z= 3101004

3101066 GETTO
RISCIAQUO
CIL+DIFFUSORE /
RINSE JET
902810: SILANOS
SRL



3101076 GETTO RISC
CIL+DIFF+COLL+RAC
C+OR+VITI /
RINSING
JET+NIPLES+COLLAR+
NUTS
902795: SILANOS
SRL



4120094 CAVALLOT
TO FISS. ASTA SUP.
CS- CL PVC BIANCO /
BRACKET ROD SUP.
CS-CL WHITE PVC

GRS04BGR:

OMNIWASH SRL -
SOCIETA' A SOCIO
UNICO



3101036 GETTO
RISCIAQUO CT
RANCILIO /
RINSING JET ROUND
BASKET RANCILIO

38124008:

RANCILIO SPA



= 3101037

3101033 UGELLO
RISCIAQUO SAB /
RINSING JET SAB
Z100P007:
S.V. ITALIA SRL

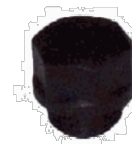

3101034

3101034 ROMPIGETT
O RISCIAQUO SAB
CT /
RINSING STOP JET
ROUND BASKET SAB
Z100P008:
S.V. ITALIA SRL



3101033

3101037 ROMPIGETT
O RISCIAQUO CT
RANCILIO /
RINSING STOP JET
ROUND BASKET
RANCILIO

38124009:

RANCILIO SPA



= 3101036

3102125 "DADO PER
RACCORDO UGELLO
SW24 X 18 X G 1/2"" /
NUT FOR
CONNECTION NOZZLE
SW24 X 18 X G 1/2
2910532:
WINTERHALTER
ITALIA SRL



nozzle=3102126

3102126 UGELLO
D18 X 25 /
NOZZLE D18 X 25
2910509:
WINTERHALTER
ITALIA SRL



nut=3102125

3101161 SPRUZZO
RISCIACQUO D.2,5 /
RINSE NOZZLE 2,5mm
140025:
ELETTROBAR
DIVISIONE DELLA
EUROTEC SRL
140028EX:
ELETTROBAR
DIVISIONE DELLA
EUROTEC SRL
REB140025:
LOTUS SPA
REB140028EX:
LOTUS SPA
REB140028EX:
COLGED
REB140025:
COLGED
*: MBM- EUROTEC
SRL - DIV. COOKING
SERVICE
80373:
ELETTROBAR
DIVISIONE DELLA
EUROTEC SRL



3101175 Z201905000
UGELLO RISCIACQUO
FAGOR /
Z201905000 NOZZLE
RINSE FAGOR
Z201905000EX:
FAGOR
INDUSTRIALE S.R.L.
12024077:
FAGOR
INDUSTRIALE S.R.L.



3101145 UGELLO DI
RISCIACQUO LASA /
RINSING JET LASA
2600130: LASA SRL



3101008 GETTO
RISCIACQUO '96+OR
SILANOS /
RINSING JET '96+OR
SILANOS
902816+904388:
SILANOS SRL

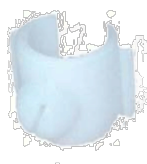

3101164 UGELLO
RISCIACQUO PROJECT
/
RINSE NOZZLE
PROJECT
17025:
SISTEMA PROJECT
SERVICE SRL



3101018 VORTICATO
RE ELICOIDALE 8MM
ATA /
HELICAL WHIRLPOOL
8mm ATA
AL, AF, AT: A.T.A.
SRL



X



Y



Y=3101014, X=3101017

3101056 ROMPIGETT
O RISCIACQUO R495-7-
9 ELETTROBAR /
RINSING STOP JET
R495-7-9 ELETTROBAR
S651, S654, S810,
S815, S830, S835:
ELETTROBAR
DIVISIONE DELLA
EUROTEC SRL



3101134 UGELLO
RISCIACQUO L40/100
A.PO /
RINSING JET L40/100
A.PO
33T1120:
ANGELO PO GRANDI
CUCINE SPA
33T1121:
ANGELO PO GRANDI
CUCINE SPA



3101137 UGELLO
RISCIACQUO
ARISTARCO /
RINSING JET
ARISTARCO
GEMINI CR,
PROGRAM 25 CR:
ARISTARCO KASTEL
5308ex:
ARISTARCO KASTEL
17155:
ARISTARCO KASTEL
SPA



3101131 GETTO
INOX OV80 1/8" /
SPRAY STAINLESS
STEEL OV80 1/8 "
380314:
COMENDA ALI SPA
380314:
HOONVED - ALI SPA



= 2101310

3101144 "NEBULIZZ
ATORE OV 1/8" 303
125LT 80" /
NOZZLE NEBULISER ø
1/8"

380317:

COMENDA ALI SPA

380317:

HOONVED - ALI SPA

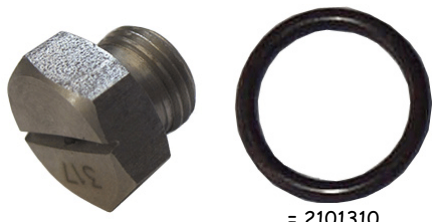

= 2101310

3101085 NEBULIZZA
TORE INOX OV12 8OLT
COMENDA /
STAINLESS STEEL
SPRAY OV12 8OLT
COMENDA

380333:

COMENDA ALI SPA

H380333:

HOONVED - ALI SPA



= 2101310

3102117 "NEBULIZZ.
INOX OV80-1/8" -37,5L"
/
NOZZLE FOR RINSE
ARM

380323:

COMENDA ALI SPA

380323:

HOONVED - ALI SPA



3101116 UGELLO
RISC. B15-16-18
OTTONE /
BRASS RINSING JET
B15-16-18

380309:

COMENDA ALI SPA



3101151 UGELLO
RISCIACQUO
COMENDA /
RINSE NOZZLE

380402:

COMENDA ALI SPA



3101107 UGELLO
INOX RISCIACQUO M5
/
STAINLESS STEEL
RINSING JET M5

DW560018:

DIHR-ALI SPA



3101192 SPRUZZATO
RE DI RISC.TRAINO
160 /
RINSE SPRAYER
TRAILER 160

CSP290:

ELETTROBAR

DIVISIONE DELLA

EUROTEC SRL

927068:

ELETTROBAR

DIVISIONE DELLA



EUROTEC SRL

3101160 UGELLO
RISCIACQUO /
RINSE NOZZLE

00014555:

ELFRAMO SPA

00018083:

ELFRAMO SPA



3101001 GETTO
RISCIACQUO LQ2°T
CIMSA /
RINSING JET LQ2°T
CIMSA

06088B: FABAR SRL



3101129 GETTO
RISCIACQUO SUP.
CESTO FISSO /
RINSING JET FOR
FIXED BASKET

984071000:

GRUPPO CIMBALI
SPA

9131014:

GRUPPO CIMBALI
SPA



3101130 GETTO
RISCIACQUO INF.
CESTO FISSO /
RINSING JET FIXED
BASKET

986056000:

GRUPPO CIMBALI
SPA

9131021:

GRUPPO CIMBALI
SPA



3101165 GETTO DI
RISCIACQUO IN
OTTONE - BRASS
RINSING SPOUT /
BRASS RINSE JET
104000: KRUPPS S.R.L.



3101146 UGELLO
RISCIACQUO LAMBER
FORO 1,5 /
RINSING JET LAMBER
HOLE 1,5

0201165: LAMBER SRL



3101191 UGELLO
RISCIACQUO MACH /
RINSE NOZZLE MACH
4327: MACH



3101159 UGELLO
RISCIACQUO MACH /
RINSING JET MACH



3101188 UGELLO
RISCIACQUO /
RINSE JET
44104000:
MODULAR SPA



3101006 GETTO
RISCIACQUO LT
CESTO Q. /
RINSING JET LT
SQUARE BASKET
23117026:
RANCILIO SPA



= 3101011

3101011 DADO
GETTO RISCIACQUO
CQ RANCILIO /
RINSING JET NUT
SQUARE BASKET
RANCILIO
38123209:
RANCILIO SPA



= 3101006

3101171 UGELLO DI
RISCIACQUO /
RINSING JET
4022:
UNIVER-BAR SRL



3101024 TAPPO
GIRANTE RISCIACQUO
F2 C34 /
RINSING FAN CAP F2
C34
160718:
COMENDA ALI SPA
H160718:
HOONVED - ALI SPA



= 2101308

3101135 TAPPO PER
BRACC. RISC. SE NE /
PLUG FOR RINSE
ARMS SE NE
160754:
COMENDA ALI SPA



2101314

3101059 TAPPO
GIRANTE RISCIACQUO
/
RINSING FAN CAP
906450: SILANOS
SRL



3101187 TAPPO
BRACCIO GIRANTE
RISC. /
END CAP FOR RINSE
ARM
12013: ADLER S.P.A.



3101060 TAPPO
BRACCIO
RISCIACQUO 048714 /
RINSE ARM CAP 048
714
048714:
ELECTROLUX
PROFESSIONAL
S.P.A.



4120051 TAPPO
GETTO LAVAGGIO /
WASH CAP
049296:
ELECTROLUX
PROFESSIONAL
S.P.A.



3102135 TAPPO
10MA /
CAP 10MA
984264000:
GRUPPO CIMBALI
SPA



3101166 TAPPO
TUBO RISCIACQUO
PASSO 12X1 /
RINSE JET TAP 12X1
104010: KRUPPS S.R.L.



3102104 TAPPO
GETTO RISCIACQUO
CQ BIANCO STAMPO
55 UNI /
CAP SPRAY RINSE
WHITE CQ
LSI022BGR:
OMNIWASH SRL



3101172 TAPPO
TERMINALE BRACCIA
RISCIACQUO /
WASH/RINSE ARMS
PLUG UNIVERBAR

4080:
UNIVER-BAR SRL



3102045 UGELLO DI
LAVAGGIO A LAMA
FORO LARGO /
WASH JET

7117: A.T.A. SRL



3102127 UGELLO DI
LAVAGGIO §§ /
NOZZLE WASH §§

7356B: A.T.A. SRL



3101189 UGELLO DI
LAVAGGIO
INCLINAZIONE 15° /
NOZZLE WASH
INCLINATION 15°

7356A: A.T.A. SRL



3101148 PORTAUG-
LLO DI LAVAGGIO
GRIGIO /
RINSE NOZZLE
HOLDER

6830: A.T.A. SRL



3102074 UGELLO DI
LAVAGGIO GRIGIO
FORO STRETTO /
WASH JET

6829: A.T.A. SRL



3101120 GETTO
LAVAGGIO 2
COMENDA /
WASH JET 2
COMENDA

170906:
COMENDA ALI SPA



3101119 UGELLO
LAVAGGIO B
COMENDA /
WASH JET B
COMENDA

170956:
COMENDA ALI SPA
C6E:



= 2101187

HOONVED - ALI SPA

3102071 UGELLO
LAV.MUL.F45/55 /
NOZZLE FOR WASH-
UP F45/55

170947:
COMENDA ALI SPA



= 2101187

3102048 UGELLO
LAVAGGIO A TAGLIO
B10-BR11 COMENDA /
WASH NOZZLE B10-
BR11 COMENDA

170924:
COMENDA ALI SPA



= 2101388

3101117 GETTO A
MORS SIN C34 TAG 5 /
CLAMP JET C34 TAG 5

170918:
COMENDA ALI SPA

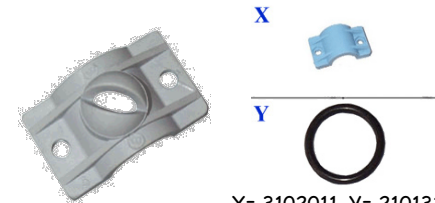

X= 3102011, Y= 2101314

3102009 GETTO
LAVAGGIO SX F2
COMENDA /
LEFT WASH JET F2
COMENDA

170916:
COMENDA ALI SPA

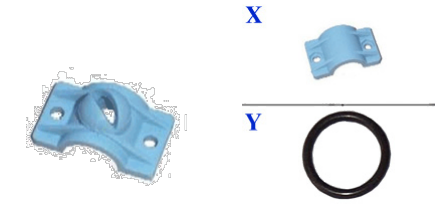

X= 3102011, Y= 2101314

3102010 GETTO
LAVAGGIO DX
COMENDA /
RIGHT WASH JET
COMENDA

170915:
COMENDA ALI SPA

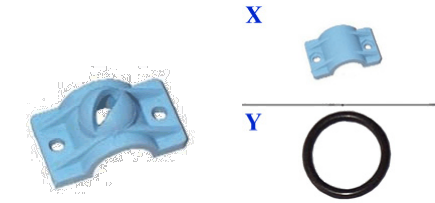

X= 3102011, Y= 2101314

3102068 -GETTO A
MORSETTO DESTRO
C34 TAG 5 /
JET CLAMP RIGHT C34
TAG 5

170917:
COMENDA ALI SPA

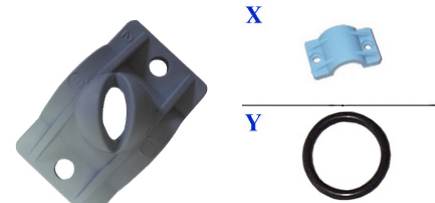

X= 3102011, Y= 2101314

3102034 GETTO
MORS.UGELLO RISC.
NEXL-S /
RINSING JET NEXL-S

170926:
COMENDA ALI SPA

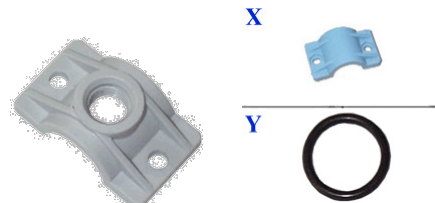

X= 3102011, Y= 2101314

3102123 UGELLO
LAVAGGIO. D 35 T.
ASSIALE /
NOZZLE WASH. D 35 T.
AXIAL

170921:

COMENDA ALI SPA

H170921:

HOONVED - ALI SPA



3102124 UGELLO
LAVAGGIO
.LATERALE AC91-101 /
NOZZLE WASH. SIDE
AC91-101

170962:

COMENDA ALI SPA

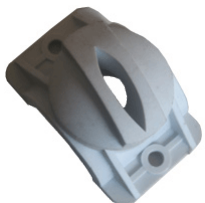

3102112 UGELLO
LAVAGGIO T.ASSIALE
/
WASH JET

170910:

COMENDA ALI SPA



= 3102051

4120425 CONTROFL
ANGIA BRACCI
AC91/101 /
COUNTERFLANGE
FOR WASH ARM
AC91/101

180216:

COMENDA ALI SPA

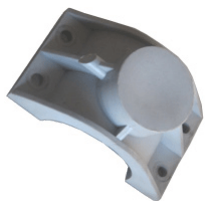

3102011 STAFFA
GETTO LAVAGGIO F2
C34 /
WASH JET STIRRUP F2
C34

180213:

COMENDA ALI SPA

180213:

HOONVED - ALI SPA

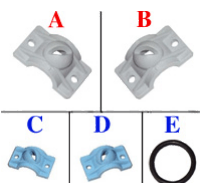

A=3101087, B= 3101088,
C=3102009, D=3102010,
E= 2101314

3102051 CONTROFL
ANGIA UGELLO
LAVAGGIO /
COUNTERFLANGE -
WASH JET S-N

180211:

COMENDA ALI SPA



3101113 GETTO
LAVAGGIO X
MULIN.F2 C /
ROD WASH JET F2 C

170927:

COMENDA ALI SPA



=2101314

3101118 GETTO
CIECO MULINELLO F2
COMENDA /
BLIND JET ROD F2
COMENDA

170928:

COMENDA ALI SPA



=2101314

3101098 TESTA
UGELLO LAVAGGIO 95
APERTO 3,5 DIHR /
OPENED WASH JET
HEAD 95 3,5 DIHR

DW10369:

DIHR-ALI SPA

DW10357:

DIHR-ALI SPA



3101141 TESTA
UGELLO LAVAGGIO
CHIUSO DIHR /
CLOSED WASH JET
DIHR

DW10370:

DIHR-ALI SPA

DW10358:

DIHR-ALI SPA



3101108 UGELLO
LAVAGGIO
COMPLETO /
COMPLETE WASH JET

DW18135:

DIHR-ALI SPA



3102052 UGELLO
LAV. D.28 ALTO /
HIGH WASH JET D.28

DW10261:

DIHR-ALI SPA

DW10211:

DIHR-ALI SPA



3101181 ELICA
FILETTATA
LAVAGGIO /
PROPELLER WASH
THREAD

119003:

ELETTROBAR
DIVISIONE DELLA
EUROTEC SRL



=3101182

3101182 SPRUZZO
LAVAGGIO SUP. S621-
3- /
UPPER WASH SPRAY
S621-3-

140010:

ELETTROBAR
DIVISIONE DELLA
EUROTEC SRL



=3101181

3102030 ELICA
SPRUZZO LAVAGGIO /
INNER NOZZLE
119004:

ELETTROBAR
DIVISIONE DELLA
EUROTEC SRL

*:
MBM- EUROTEC SRL -
DIV. COOKING
SERVICE



3102033 SPRUZZO
LAVAGGIO GRIGIO 11-
353 /
GREY WASH SPRAY
11-353

40F ELECTRONIC,
E40, E40H, E41, E42,
E45, E46:

ELETTROBAR
DIVISIONE DELLA
EUROTEC SRL

46, 460, 11F, 11FD,
E35, E35H, 40F,
40FD, 400F, 400FD,:

ELETTROBAR
DIVISIONE DELLA
EUROTEC SRL



= 3102044

3102088 SPRUZZATO
RE DI LAVAGGIO PER
LAVASTOVIGLIE /
WASH JET

*:
MBM- EUROTEC SRL -
DIV. COOKING
SERVICE

140008:
ELETTROBAR
DIVISIONE DELLA
EUROTEC SRL



3102044 GHIERA
LAVAGGIO /
WASH RING

46, 460, 50F, 50FP,
50FD,
50FELECTRONIC,
500F, 500FD:

ELETTROBAR
DIVISIONE DELLA
EUROTEC SRL



= 3102033

3102097 COLLARE
PER SPRUZZATORE DI
LAVAGGIO PER /
COLLAR FOR SPRAY
WASH

110001:
ELETTROBAR
DIVISIONE DELLA
EUROTEC SRL

*:
MBM- EUROTEC SRL -
DIV. COOKING
SERVICE



3102075 SPRUZZATO
RE LAV.IN PL.DIRITTO
(CSP2503) /
WASH NOZZLE
STRAIGHT

926170:

ELETTROBAR
DIVISIONE DELLA
EUROTEC SRL

*:
MBM- EUROTEC SRL -
DIV. COOKING
SERVICE

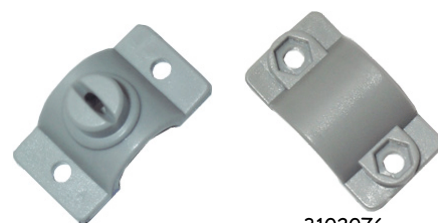

3102076

3102077 SPRUZZATO
RE LAV.IN
PLAST.INCL.(CSP2501)

/
WASH NOZZLE

926169:

ELETTROBAR
*:

MBM- EUROTEC SRL -
DIV. COOKING
SERVICE
CSP2501: COLGED

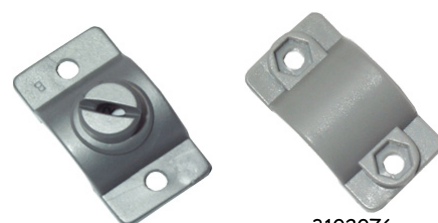

= 3102076

3102076 SUPPORTO
IN PL.FISSA
SPRUZZ.LAV.(DWS511)

/
NOZZLE HOLDER

*:
MBM- EUROTEC SRL -
DIV. COOKING
SERVICE

926171:
ELETTROBAR
DIVISIONE DELLA
EUROTEC SRL

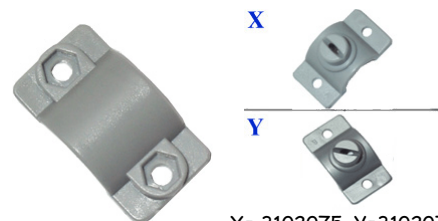

X= 3102075, Y=3102077

3102080 SPRUZZO
LAVAGGIO 44TERZ. /
WASH NOZZLE

140021:

ELETTROBAR
DIVISIONE DELLA
EUROTEC SRL

*:
MBM- EUROTEC SRL -
DIV. COOKING
SERVICE



3102101 ANIMA
UGELLO LANCIA
MM=5 /
WASHING JET 5mm

00079102:

ELFRAMO SPA



X= 3102100, Y= 3124152

3124152 GHIERA 1"
ANIMA UGELLO
LANCIA /

"LOCKING RING 1""
00004933:
ELFRAMO SPA

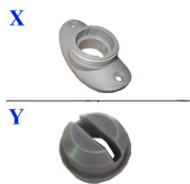

X= 3102100, Y= 3102101

3102100 PORTAUGE
LLO LAV. FLANGIATO
ET /
WASHING JET-
HOLDER ET
00079101:
ELFRAMO SPA



X= 3102101, Y= 3124152

3102027 GETTO
LAVAGGIO BASSO /
LOW WASH JET
00011340:
ELFRAMO SPA



3102105 Z400709000
UGELLI LAVAGGIO
FAGOR /
Z400709000 NOZZLE
WASH FAGOR
Z400709000EX:
FAGOR
INDUSTRIALE S.R.L.
12023732:
FAGOR
INDUSTRIALE S.R.L.



3102020 GETTO
LAVAGGIO /
WASH JET
9021015:
GRUPPO CIMBALI
SPA



= 3102021

3102021 DIFFUSORE
GETTO LAVAGGIO /
WASH JET DIFFUSER
9021016:
GRUPPO CIMBALI
SPA



= 3102020

3102069 GETTO
LAVAGGIO APS48 /
WASH NOZZLE APS48
APS48:
HOONVED - ALI SPA



3102081 GETTO
LAVAGGIO PICCOLO O
3,6 /
WASH JET 3,6
30390:
HOONVED - ALI SPA



3102058 GETTO
LAVAGGIO D.7mm
HNVD /
WASH JET D.7mm
HNVD
25073:
HOONVED - ALI SPA



3102070 UGELLO
LAVAGGIO DA 4,5 /
WASH JET D. 4,5
H170960:
HOONVED - ALI SPA



3101136 GETTO
LAVAGGIO LUXIA /
WASH JET LUXIA
L3319:
LUXIA GROUP SRL
L3321:
LUXIA GROUP SRL



3101126 GETTO
LAVAGGIO DX CQ IME
/
RIGHT WASH JET IME
LSI015BGR:
OMNIWASH SRL
LSI015:
OMNIWASH SRL



= 3101125

3101127 GETTO
LAVAGGIO SX CQ IME
/
LEFT WASH JET IME
LSI016BGR:
OMNIWASH SRL
LSI016:
OMNIWASH SRL



= 3101125

3102060 GETTO
LAVAG. CQ DX LARGO
STAMPO 46 UNI /
WASH JET
LSISA15BGR:
OMNIWASH SRL -
SOCIETA' A SOCIO
UNICO



= 3101125

3102087 GETTO
LAV. CQ SX LARGO
BIANCO STAMPO 46
UNI /
WASH JET SQUARE
BASKET
LSISA16BGR:
OMNIWASH SRL
LSISA16B:
OMNIWASH SRL -
SOCIETA' A SOCIO
UNICO



3102062 TAPPO
GETTO LAVAGGIO CQ
STAMPO 54 UNI /
JET WASH CAP CQ
LSI018BGR:
OMNIWASH SRL
LSI018:
OMNIWASH SRL



3101125 GHIERA X
GETTI LAV. CQ IME /
RING FOR WASH JET
IME
LSI017BGR:
OMNIWASH SRL -
SOCIETA' A SOCIO
UNICO

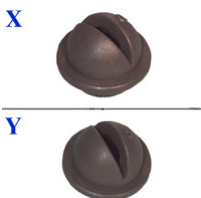

X= 3101126, Y= 3101127

3102002 ROMPIGETT
O LAVAGGIO CT /
WASH STOP JET
ROUND BASKET
GLO31BGR:
OMNIWASH SRL -
SOCIETA' A SOCIO
UNICO



= 3102003

3102003 GETTO
LAVAGGIO CT IME /
WASH JET ROUND
BASKET IME
GLO30BGR:
OMNIWASH SRL -
SOCIETA' A SOCIO
UNICO



= 3102002

4120421 TAPPO
ASTA RISC. CT GRIGIO
RAL 7040 /
RINSE ARM CAP GREY
RAL 7040
GRO19GBGR:
OMNIWASH SRL -
SOCIETA' A SOCIO



3102040 SUPPORTO
GETTO CT LAVAGGIO
IME /
JET SUPPORT ROUND
BASKET IME
GLO32:
OMNIWASH SRL -
SOCIETA' A SOCIO
UNICO



X=3102002, Y=3102003,

Z= 3102041

3102041 SUPPORTO
GETTO LAVAGGIO
INF. CT IME /
LOWER WASH JET
SUPPORT ROUND
BASKET IME
GLO33:
OMNIWASH SRL -
SOCIETA' A SOCIO
UNICO

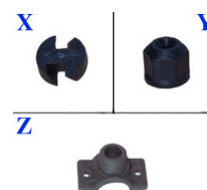

X=3102002, Y=
3102003, Z= 3102040

4120422 GANCIO
FISS. ASTA INT. CS-CL
GRIGIO /
HOOK FIXING ROD
GRS05BGR:
OMNIWASH SRL

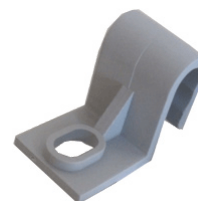

3102005 GETTO
LAVAGGIO CT
RANCILIO /
WASH JET ROUND
BASKET RANCILIO
38124010:
RANCILIO SPA



= 3102006

3102006 ROMPIGETT
O LAVAGGIO CT
RANCILIO /
WASH STOP JET
ROUND BASKET
RANCILIO
38124011:
RANCILIO SPA



= 3102005

3102016 GETTO
LAVAGGIO CESTO
QUADRO /
WASH JET SQUARE
BASKET
38123210:
RANCILIO SPA



= 3102022

3102042 GETTO
LAVAGGIO BLU'
RANCILIO /
BLUE WASH JET
RANCILIO
38123287:
RANCILIO SPA



= 3102022

3102022 DADO
GETTO LAVAGGIO CQ
RANCILIO /
WASH JET NUT
SQUARE BASKET
RANCILIO
38123208:
RANCILIO SPA



X= 3102016, Y=3102042

3102012 GETTO
LAVAGGIO CT
SILANOS /
WASH JET ROUND
BASKET SILANOS
908070: **SILANOS**
SRL



X



Y



X= 3102013, Y=3102043

3102013 ROMPIGETT
O LAVAGGIO CT
SILANOS /
WASH STOP JET
ROUND BASKET
SILANOS
908060: **SILANOS**
SRL



X



Y



X= 3102012, Y=3102043

3102043 GETTO
LAV.CIL+DIFF+COLL+
RACC+OR+VITI /
WASH JET +O RING
902793: **SILANOS**
SRL



X



Y



X= 3102012, Y= 3102013

3101162 GETTO
LAVAGGIO OVALE DX
/
RIGHT OVAL WASH
JET
902801: **SILANOS**
SRL



3102064 COLLARE
GETTO LAVAGGIO
OVALE/CILINDRICO /
WASH JET COLLAR
901701: **SILANOS**
SRL



3102046 UGELLO
LAVAGGIO AD
INCASTRO X T50P
/ WASH JET X T50P
20049:
SISTEMA PROJECT
SERVICE SRL



3102004 ROMPIGETT
O LAVAGGIO SAB CT /
WASH STOP JET
ROUND BASKET SAB
Z100P006:
S.V. ITALIA SRL



3102073 GETTO
LAVAGGIO INFERIORE
GS29 /
WASH JET GS29
62001808:
WINTERHALTER
ITALIA SRL



3102084 GETTO
LAVAGGIO A CLIP /
CLIP WASH JET
34263:
HOONVED - ALI SPA
37722:
HOONVED - ALI SPA



gasket=2101137,
spring=1117069

3102092 GETTO
LAVANTE IN
PLASTICA SINISTRO
(FORO STRETTO) /
WASH JET
104020SX:
KRUPPS S.R.L.



3102099 GETTO
LAVAGGIO DESTRO /
LEFT WASH JET
104020: **KRUPPS S.R.L.**



3102093 TAPPO
LAVANTE IN
PLASTICA - PLASTIC
WASHING TAP /
PLASTIC WASHING
TAP
104030: **KRUPPS S.R.L.**



3101049 TAPPO
CHIUSURA FORO
LAMPADA /
BLANK PLATES
160733:
COMENDA ALI SPA



3102113 TAPPO
BRACCI LAVAGGIO
SE/1 /
WASH JET CAP
210406:
COMENDA ALI SPA



3102116 TAPPO
TUBO LAV.B10-11-BR
BC /
END CAP FOR WASH
ARM B10-11-BR BC
160710:
COMENDA ALI SPA



3101075 TAPPO
CORPO GRUPPO
INFER. /
BLANK PLATE

480087:

ELETTROBAR
DIVISIONE DELLA
EUROTEC SRL



3101081 TAPPO
FILETT. ASTA RISC.
STS/APS /
RINSING ROD CAP
STS/APS

32359:

HOONVED - ALI SPA



3101090 PORTAG.OT
T. A 90° X RISC. /
RINSE NIPPLE 90°

280529:

COMENDA ALI SPA



4127039 RUBINETTO
MINISFERA FF 1/4" D.8
/
"MINIBALL COCK FF
1/4" D.8"



4127008 RUBINETTO
MINISFERA FF3/8 D. 8 /
MINIBALL COCK FF3/8
D.8



4127088 RUBINETTO
MINISFERA FF 1/2 /
MINIBALL COCK FF1/2

1031400300:

MARENO INDUSTRIE
ALI SPA

MA1031400300:

SILKO ALI SPA



4127089 RUBINETTO
MINISFERA M 3/4 F 3/4 /
MINIBALL COCK M 3/4
F3/4



4127014 RUBINETTO
ADDOLCITORE AD /
WATER-SOFTNER
COCK AD



= 2101317

4127123 RUBINETTO
ADDOLCITORE 3/8" F /
"WATER-SOFTNER TAP
3/8" F"



2101378

4127122 RUBINETTO
ADDOLCITORE 3/8"
M(V) /
"WATER-SOFTNER TAP
3/8" M(V)"



2101378

4127142 RUBINETTO
ADDOLCITORE 3/4" M /
WATER SOFTNER TAP
3/4" M



= 2101379

4127194 GRUPPO
ENTRATA ACQUA /
GROUP WATER INLET
OC8683:

ELECTROLUX
PROFESSIONAL
S.P.A.



4127078 VALVOLA
NON RITORNO F 1/4" /
"ANTI-EDDY VALVE F
1/4" F"

00220419:

ELFRAMO SPA



raccordo=3118019

4127177 VALVOLA X
SCARICO CON SFIATO
/
VALVE FOR DRAIN
WITH BREAT. PIPE

15818:

HOONVED - ALI SPA

H15818:

COMENDA ALI SPA



4127046 VALVOLA
NON RITORNO PER
RISCIAQUO A
FREDDO /
COLD RINSING ANTI-
EDDY VALVE



1124092 VALVOLA
ANTIVUOTO "B-FP11-
E2-C" /
"NO-EMPTY SOLENOID
VALVE "B-F-C""

620535:

COMENDA ALI SPA
2802*: ARISTARCO

620243:

COMENDA ALI SPA
33D2330:
ANGELO PO GRANDI
CUCINE SPA
33D2100: ANGELO PO
DW999900006:

DIHR-ALI SPA

DW15201:

DIHR-ALI SPA

620535: HOONVED

0500605: LAMBER

33506: HOONVED

23180203: ELFRAMO

0L1892: ELECTROLUX

2376*:

ARISTARCO KASTEL



3118034 Raccordo
portavalvola /
valve connection

4222: UNIVER-BAR
SRL



4127081 VALVOLA
ANTIRIFLUSSO LS3 /
ANTI-REFLUX VALVE
LS3

LS3: LASA SRL



4127051 VALVOLA
ANTIRIFLUSSO DVGW
/
BACK FLOW
RESTRICTOR

TR2433: SILANOS
SRL



4127221 VALVOLA
DI SFIATO POMPA
SCARICO /
BREATHER VALVE
DRAIN PUMP

144003:

ELETTROBAR
DIVISIONE DELLA



EUROTEC SRL

4127214 GRUPPO
VALVOLA DI SFIATO X
PS LA40 /
BREATHER VALVE
ASSEMBLY X PS LA40
144992:

ELETTROBAR
DIVISIONE DELLA
EUROTEC SRL



4127097 RUBINETTO
COMPLETO /
COMPLETE TAP

101010: FABAR SRL



2107188 BOCCOLE
ANTIF.MUL.RISC. /
BUSH RINSE ARM

11351: ADLER S.P.A.



2107066 BOCCOLA D
26X8 /
BUSH D 26X8

36D0740:

ANGELO PO GRANDI
CUCINE SPA



2107210 BRONZINA
SUPERIORE TESTA
ROTANTE /
UPPER BUSHING
ROTATING HEAD

8444: A.T.A. SRL



2107213 BRONZINA
GIRANTE INOX /
WHEEL BEARING
STEEL

8619: A.T.A. SRL



2107209 BRONZINA
INFERIORE TESTA
ROTANTE /
LOWER BUSHING
ROTATING HEAD

8449: A.T.A. SRL



2107116 BRONZINA
GIRANTE AF/AL55
ALP33 /
BEARING FAN AF/AL55
ALP33
4334: **A.T.A. SRL**



2107028 BRONZINA
GIRANTE AT/ALP42-44
/
BEARING FAN AT/ALP
42-44
9632: **A.T.A. SRL**



2107031 BRONZINA
GIRANTE LAVAGGIO X
AF /
BEARING FAN X AF
4609: **A.T.A. SRL**



2107078 BOCCOLA
"NYLINER" A INNESTO
7 /
""NYLINER"" BUSH"
190632: **COMENDA
ALI SPA**



2107059 BUSSOLA
MULINELLO
RISCIAQUO FC /
BUSH FC
190652:
COMENDA ALI SPA



2107065 BUSSOLA
MULINELLO
RISCIAQUO "C" /
BUSH FOR C95-155-165
RINSE ARM
190641:
COMENDA ALI SPA
190641:
HOONVED



2107063 BUSSOLA
MUL.RISC."G"1A SERIE
/
"RINSE ROD BUSH
""G""1A SERIES"
190613:
COMENDA ALI SPA



2107089 BUSSOLA
COMENDA /
BUSH COMENDA
330841:
COMENDA ALI SPA



2107061 BUSSOLA
MICRO PORTA B.F.
LAV /
BUSH DOOR SWITCH
F2-20-45-5
330820:
COMENDA ALI SPA



2107172 BUSS.D.14
MOPL.S 3^S PREL.PRER
/
BUSH
190623:
COMENDA ALI SPA



2107051 RONDELLA
SCORRIMENTO PTFE /
BEARING BUSH
DW13319:
DIHR-ALI SPA



2107056 BUSSOLA
NYLON D.22X13 /
BUSHING NYLON
D.22X13
DW75204:
DIHR-ALI SPA



2107057 BUSSOLA
OT K18 ES22X14 /
BUSHING OT K18
ES22X14
DW75203:
DIHR-ALI SPA



2107058 BUSSOLA
PER RULLINO
SPORTELLLO /
BUSHING FOR ROLLER
DOOR
DW10800231:
DIHR-ALI SPA



2107202 BOCCOLA X
BRACCIO LAVAGGIO
INOX C600 /
BUSH FOR ARM
WASHING STAINLESS
C600
79044:
ELETTROBAR



2107233 BUSSOLA
PETTINE LAV.X5 /
WASHING ARM
BUSHING
417111:
ELETTROBAR
DIVISIONE DELLA
EUROTEC SRL



2107208 BUSHING /
BUSHING
228643:
HOBART GmbH



2107062 BUSSOLA
ALGOFLON 35 /
BUSH ALGOFLON 35
H190621:
HOONVED - ALI SPA
190621:
COMENDA ALI SPA



2107060 BUSSOLA
PER MULINELLO LAV.
C /
BUSH FOR C95-155-165
WASH ARM
H190636:
HOONVED - ALI SPA
190636:
COMENDA ALI SPA



2107072 BUSSOLA
TIPO H370 FM 2023-21 /
BUSH TYPE H370 FM
2023-21
35968:
HOONVED - ALI SPA



2107196 BUSSOLA
INNESTO MOLLA ST/E /
BUSH
190688:
HOONVED - ALI SPA



2107197 BUSSOLA
GUIDA MOLLA FERMO
PORT /
BUSH
37448:
HOONVED - ALI SPA



2107224 BUSSOLA
GUIDA MOLLA FERMO
PORTA /
GUIDE BUSH SPRING
DOOR STOP
190687:
HOONVED - ALI SPA
190687:
COMENDA ALI SPA



2107067 BUSSOLA
CENTR.ASTA
LAV.INF.STS /
BUSH
18703:
HOONVED - ALI SPA



2107117 BUSSOLA X
MUL.INOX
BHC(HV35233 /
BUSH BHC(HV35233
35233:
HOONVED - ALI SPA
190667:
COMENDA ALI SPA



2107092 BUSSOLA
CENTRALE
H.28MULIN.SUP /
WASH ARM BUSH
34262:
HOONVED - ALI SPA



2107070 BUSSOLA
CENTRALE ASTA
LAV.INF HOONVED /
BUSH FOR WASH ARM
HOONVED
17971:
HOONVED - ALI SPA



2107075 BUSSOLA
CENTRALE ASTA LAV
HNVD /
BUSH FOR WASH ARM
HOONVED
17972:
HOONVED - ALI SPA



2107073 BUSSOLA
TIPO H370 SM 2023-20 /
BUSH H370 SM 2023-20
36187:
HOONVED - ALI SPA



2107074 BUSSOLA
INOX X
MULIN.LAV.CAPOT /
STAINLESS STEEL
BUSH FOR ARM
35977EX:
HOONVED - ALI SPA



2107146 BOCCOLA
RIDUZIONE PERNO
LAV. N45/N700/N1000 /
BUSH REDUCTION
PIVOT LAV. N45 / N700
/ N1000
955076ex:
SILANOS SRL
908456:
SILANOS SRL



2107115 BUSSOLA
MULIN.LAV.GE /
BUSH WASH ARM GE
H190669:
HOONVED - ALI SPA
190669:
COMENDA ALI SPA



2107071 BUSSOLA
MULINELLO F 45 /
BUSH FOR PLASTIC
ARM F45
H190649:
HOONVED
190649:
COMENDA ALI SPA



2107050 BUSSOLA
ALGOFL.MULINELLO
C /
BUSH ALGOFL. ROD C
H190617: HOONVED
190617:
COMENDA ALI SPA



2107077 BUSSOLA
MOZZO MULINELLO
RISCIACQUO /
BUSH RINSE
IMPELLER HUB
34383:
HOONVED - ALI SPA
H34383:
COMENDA ALI SPA



2107173 BUSSOLA
CENTRALE RIDUZIONE
53/60 /
BUSH CENTER
REDUCTION 53/60
32888:
HOONVED - ALI SPA



2107174 BUSSOLA
CENTRALE ROTANTE -
LAVAGGIO INFERIORE
STS43/48 /
BUSHING FOR CENTER
BOSS
32887:
HOONVED - ALI SPA

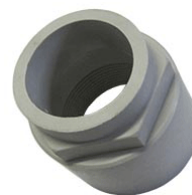

2107145 BUSSOLA
CARBOGRAFITE
GRANDE Ø26 MM /
BUSH Ø26 MM
104110:
KRUPPS S.R.L.



2107144 BUSSOLA
CARBOGRAFITE
PICCOLA Ø14 MM/
10mm interno /
SMALL BUSHING -
Carbographite diameter 14
mm / 10 mm internal
104100: KRUPPS S.R.L.



Ø= outside 14mm,
Ø = inside 10mm

2107225 BOCCOLE
IN PVC PER MOLLA
CAPPOTTA /
HOOD SPRING
LOCKING ROLLER
1202090:
KRUPPS S.R.L.



2107206 GUARNIZIO
NE NYLTITE M12 /
GASKET NYLTITE M12
0200295:
LAMBER DI AFFABA
FRANCESCO & C.



2107099 BOCCOLE
PER CROCERA 4 VIE /
BUSH
L3360: LUXIA SRL



2107135 BOCCOLE
PER CROCERA K1300 /
BUSH USAGE FOR
WASH ARM K1300
L3361: LUXIA SRL



2107207 SUPPORTO
PER GIRANTE LB /
BUSH
45106600:
MODULAR SPA



2107008 BUSSOLA
GIRANTE LT/S N /
ROD BUSH LT/S N
36930097:
RANCILIO SPA



2107016 BOCCOLA
GIRANTE 1° TIPO
RANCILIO /
ROD SLIDE 1° TYPE
RANCILIO
36930081:
RANCILIO SPA



2107166 BOCCOLA
TEFLON /
TEFLON BUSH
2526:
UNIVER-BAR SRL



2107156 BOCCOLA
TEFLON CON
RONDELLA /
TEFLON BUSH
2528:
UNIVER-BAR SRL



2107190 BOCCOLA
LUNGA SCORRIMENTO
ASTA PORTA /
BUSH LONG SLIDE
ROD DOOR
3282:
UNIVER-BAR SRL



2107168 BOCCOLA
CORTA SCORRIMENTO
ASTA PORTA /
BUSH
1578: UNIVER-BAR
SRL



2107215 GUARNIZIO
NE 68x55x2mm /
GASKET 68x55x2mm
2130:
ARISTARCO SPA



2107212 BRONZINA
CORTA GIRANTE INOX
/
SHORT WHEEL
BEARING STEEL
8633: A.T.A. SRL



2107093 GUARNIZIO
NE TEFLON /
TEFLON GASKET
4366: A.T.A. SRL



2107122 BUSSOLA
MULINELLO
RISCIACQUO BHC/1
HV34383 /
BUSH REEL RINSE BHC
/ 1 HV34383
190670:
COMENDA ALI SPA



2107029 BOCCOLA
DI SCORR. PETTINE
22/66 /
ROD BUSH
44F, 440F, 22F, 40F,
E50, E51, E52, 10, 12,
14, 66:
ELETTROBAR
DIVISIONE DELLA
EUROTEC SRL



2107087 GUARNIZIO
NE PTFE 18-22-2 /
GASKET PTFE 18-22-2
986005000: GRUPPO
CIMBALI SPA



2107088 GUARNIZIO
NE TEFLON COLON.NP
/
TEFLON GASKET NP
9111002ex:
GRUPPO CIMBALI
SPA



2107007 RONDELLA
PERNO GIRANTE
LT/SN /
ROD PIVOT WASHER
LT/SN
36930096:
RANCILIO SPA



2107017 RONDELLA
TEFLON NERO GR NE /
BLACK TEFLON ROD
GR NE
36230006:
RANCILIO SPA

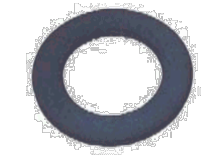

2107126 ANELLO
TENUTA PER
SUPP.LAVAGGIO /
RING SEAL SUPPORT
FOR WASHING

80184:

ELETTROBAR
DIVISIONE DELLA
EUROTEC SRL



2107154 GUARNIZIO
NE PIATTA IN
SUGHERO /
SEAL FLAT IN CORK

31785:

HOONVED - ALI SPA



2107147 GUARNIZIO
NE 1"1/4 /
"GASKET 1"1/4"



2107006 GUARNIZIO
NE FAEMA FUNGO
TEFLON /
TEFLON FUNGUS
GASKET FAEMA

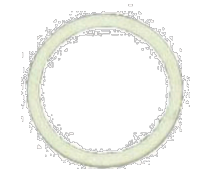

2102018 GUARNIZIO
NE DADO SNODO /
ARTICULATION NUT
GASKET

36220009:

RANCILIO SPA

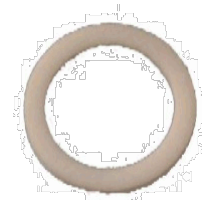

2107157 GUARNIZIO
NE 14,5X10X1,5 PTFE /
TEFLON GASKET
14,5X10X1,5



2107162 GUARNIZIO
NE 20X10X1,5 PTFE /
GASKET 20X10X1,5
PTFE



= 1125138

2107028 BRONZINA
GIRANTE AT/ALP42-44
/
BEARING FAN AT/ALP
42-44

9632: A.T.A. SRL



2107031 BRONZINA
GIRANTE LAVAGGIO X
AF /
BEARING FAN X AF

4609: A.T.A. SRL



2107116 BRONZINA
GIRANTE AF/AL55
ALP33 /
BEARING FAN AF/AL55
ALP33

4334: A.T.A. SRL



2107074 BUSSOLA
INOX X
MULIN.LAV.CAPOT /
STAINLESS STEEL
BUSH FOR ARM

35977EX:

HOONVED - ALI SPA

36188: HOONVED



2107173 BUSSOLA
CENTRALE RIDUZIONE
53/60 /
BUSH CENTER
REDUCTION 53/60

32888:

HOONVED - ALI SPA



2107174 BUSSOLA
CENTRALE ROTANTE -
LAVAGGIO INFERIORE
STS43/48 /
BUSHING FOR CENTER
BOSS

32887:

HOONVED - ALI SPA

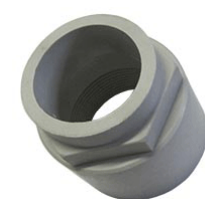

2107207 SUPPORTO
PER GIRANTE LB /
SUPPORT FOR FAN LB

45106600:

MODULAR SPA



2107188 BOCCOLE
ANTIF.MUL.RISC. /
BUSH FOR RINSE ARM

11351: ADLER S.P.A.

11351: FABAR SRL



2107066 BOCCOLA D
26X8 /
BUSH D 26X8
36D0740:
ANGELO PO GRANDI
CUCINE SPA



2107209 BRONZINA
INFERIORE TESTA
ROTANTE /
LOWER BUSHING
ROTATING HEAD
8449: A.T.A. SRL



2107210 BRONZINA
SUPERIORE TESTA
ROTANTE /
UPPER BUSHING
ROTATING HEAD
8444: A.T.A. SRL



2107212 BRONZINA
CORTA GIRANTE INOX
/
SHORT WHEEL
BEARING STEEL
8633: A.T.A. SRL



2107213 BRONZINA
GIRANTE INOX /
WHEEL BEARING
STEEL
8619: A.T.A. SRL



2107050 BUSSOLA
ALGOFL.MULINELLO
C /
BUSH ALGOFL. ROD C
190617: COMENDA
190617: HOONVED



2107062 BUSSOLA
ALGOFLON 35 /
BUSH ALGOFLON 35
190621:
COMENDA ALI SPA
H190621:
HOONVED - ALI SPA



2107071 BUSSOLA
MULINELLO F 45 /
BUSH FOR PLASTIC
ARM F45
190649: COMENDA
190624ex: COMENDA
190649: HOONVED



H190624EX:
HOONVED - ALI SPA

2107063 BUSSOLA
MUL.RISC."G"1A SERIE
/
"RINSE ROD BUSH
""G""1A SERIES"
190613:
COMENDA ALI SPA



2107060 BUSSOLA
PER MULINELLO LAV.
C /
BUSH FOR C95-155-165
WASH ARM
190636:
COMENDA ALI SPA
190636:
HOONVED - ALI SPA



2107065 BUSSOLA
MULINELLO
RISCIACQUO "C" /
BUSH FOR C95-155-165
RINSE ARM
190641:
COMENDA ALI SPA
190641:
HOONVED - ALI SPA



4115255 BUSSOLA X
MULIN.RISC. G
COMENDA /
"BUSH FOR S/S RINSE
ARM ""G"""
190642:
COMENDA ALI SPA



2107115 BUSSOLA
MULIN.LAV.GE /
BUSH WASH ARM GE
190669:
COMENDA ALI SPA
H190669:
HOONVED - ALI SPA



4115633 BUSSOLA
LUNGA X MULIN.
PLAST. /
LOWER BUSH FOR
WASH ARM F
190645:
COMENDA ALI SPA



4115303 MOZZO
INOX X MULINELLO
PIATTO /
WASH ARM CENTER
(STAINL.)
330895EX:
COMENDA ALI SPA

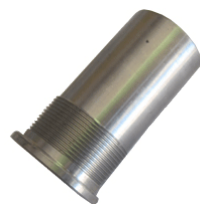

4115302 BUSSOLA
INF. X MOZZO MUL.
PIATTO /
INFERIOR BUSH FOR
HUB

190675:

COMENDA ALI SPA



4115288 BOCCOLA X
MULINELLO RISC. /
BUSH

190663:

COMENDA ALI SPA

190663:

HOONVED - ALI SPA



2107077 BUSSOLA
MOZZO MULINELLO
RISCIACQUO /
BUSH RINSE
IMPELLER HUB

H34383:

COMENDA ALI SPA

34383:

HOONVED - ALI SPA



2107122 BUSSOLA
MULINELLO
RISCIACQUO BHC/1
HV34383 /
BUSH REEL RINSE BHC
/ 1 HV34383

190670:

COMENDA ALI SPA



2107059 BUSSOLA
MULINELLO
RISCIACQUO FC /
BUSH FC

190652:

COMENDA ALI SPA



2107051 RONDELLA
SCORRIMENTO PTFE /
BEARING BUSH

DW13319:

DIHR-ALI SPA



2107056 BUSSOLA
NYLON D.22X13 /
BUSHING NYLON
D.22X13

DW75204:

DIHR-ALI SPA



3124217 GHIERA
GIRANTE PLASTICA 05

/
IMPELLER RING NUT
PLASTIC 05

DW500701:

DIHR-ALI SPA



4115886 RULLINO
PER COMANDO DEL
TRAINO /
BUSH

927092:

ELETTROBAR

*: MBM



4120530 RUBBER
BUSHING /
RUBBER BUSHING

8855001:

HOBART GmbH



2107073 BUSSOLA
TIPO H370 SM 2023-20 /
BUSH H370 SM 2023-20

36187:

HOONVED - ALI SPA



4120436
DISTANZIALE
SUPP.PORTCEST.CAP7 /
SPACER SUPPORT.
DOOR RACKS CAP7

36465:

HOONVED - ALI SPA



2107144 BUSSOLA
CARBOGRAFITE
PICCOLA Ø14 MM /
10mm interno /
SMALL BUSHING -
Carbographite diameter 14
mm / 10 mm internal

104100: KRUPPS S.R.L.



Ø= outside 14mm,
Ø=inside 10mm

2107145 BUSSOLA
CARBOGRAFITE
GRANDE Ø26 MM /
BUSH 26 MM

104110: KRUPPS S.R.L.



2107225 BOCCOLE
IN PVC PER MOLLA
CAPPOTTA /
HOOD SPRING
LOCKING ROLLER

1202090:

KRUPPS S.R.L.



4115769 PROLUNGA
SUPPORTO GETTI /
JET SUPPORT
EXTENSION
2660020: **LASA SRL**



2107135 BOCCOLE
PER CROCERA K1300 /
BUSH USAGE FOR
WASH ARM K1300
L3361: **LUXIA SRL**



2107099 BOCCOLE
PER CROCERA 4 VIE /
BUSH
L3360: **LUXIA SRL**



2107007 RONDELLA
PERNO GIRANTE
LT/SN /
ROD PIVOT WASHER
LT/SN
36930096:
RANCILIO SPA

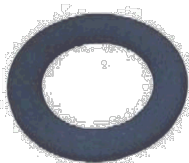

2107008 BUSSOLA
GIRANTE LT/S N /
ROD BUSH LT/S N
36930097:
RANCILIO SPA



2107016 BOCCOLA
GIRANTE 1° TIPO
RANCILIO /
ROD SLIDE 1? TYPE
RANCILIO
36930081:
RANCILIO SPA



4115121 BUSSOLA
GIRANTE RISCIAQUO
/
RINSE ARM BUSH
900520:
SILANOS SRL



4115007 BUSSOLA
GIRANTE D. 16
SILANOS /
WASH ARM BUSH D.16
SILANOS
900513:
SILANOS SRL



2107146 BOCCOLA
RIDUZIONE PERNO
LAV. N45/N700/N1000 /
BUSH REDUCTION
PIVOT LAV. N45 / N700
/ N1000



955076ex:
SILANOS SRL
908456:
SILANOS SRL

2107156 BOCCOLA
TEFLON CON
RONDELLA /
TEFLON BUSH
2528:
UNIVER-BAR SRL



2107168 BOCCOLA
CORTA SCORRIMENTO
ASTA PORTA /
BUSH FOR DOOR PIN
1578:
UNIVER-BAR SRL



2107190 BOCCOLA
LUNGA SCORRIMENTO
ASTA PORTA /
BUSH LONG SLIDE
ROD DOOR
3282:
UNIVER-BAR SRL



2107166 BOCCOLA
TEFLON /
TEFLON BUSH
2526:
UNIVER-BAR SRL



2107061 BUSSOLA
MICRO PORTA B.F.
LAV /
BUSH DOOR SWITCH
F2-20-45-5
330820:
COMENDA ALI SPA



2107057 BUSSOLA
OT K18 ES22X14 /
BUSHING OT K18
ES22X14
DW75203:
DIHR-ALI SPA



2107058 BUSSOLA
PER RULLINO
SPORTELLO /
BUSHING FOR ROLLER
DOOR

DW10800231:

DIHR-ALI SPA



2107117 BUSSOLA X
MUL.INOX
BHC(HV35233 /
BUSH BHC(HV35233

190667:

COMENDA ALI SPA

35233:

HOONVED - ALI SPA



2107092 BUSSOLA
CENTRALE
H.28MULIN.SUP /
WASH ARM BUSH

34262: HOONVED -

ALI SPA



4115517 TRONCHET
TO ASPIRAZIONE C85-
140 /
INTAKE FITTING C85-
140

180235:

COMENDA ALI SPA



2107067 BUSSOLA
CENTR.ASTA
LAV.INF.STS /
BUSH

18703:

HOONVED - ALI SPA



2107075 BUSSOLA
CENTRALE ASTA LAV
HNVD /
BUSH FOR WASH ARM
HOONVED

17972:

HOONVED - ALI SPA



2107070 BUSSOLA
CENTRALE ASTA
LAV.INF HOONVED /
BUSH FOR WASH ARM
HOONVED

17971:

HOONVED - ALI SPA



2107078 BOCCOLA
"NYLINER" A INNESTO
7 /

""NYLINER"" BUSH"

190632:

COMENDA ALI SPA



2107215 GUARNIZIO
NE 68x55x2mm /
GASKET 68x55x2mm

2130:

ARISTARCO SPA



2107093 GUARNIZIO
NE TEFLON /
TEFLON GASKET

4366: A.T.A. SRL



2107029 BOCCOLA
DI SCORR. PETTINE

22/66 /

ROD BUSH

44F, 440F, 22F, 40F,

E50, E51, E52, 10, 12,

14, 66:

ELETTROBAR

E60, E65, E100, E110,

E120, E140,

CLEAN100:

ELETTROBAR



2107126 ANELLO

TENUTA PER
SUPP.LAVAGGIO /
RING SEAL SUPPORT
FOR WASHING

80184:

ELETTROBAR

DIVISIONE DELLA

EUROTEC SRL



2107087 GUARNIZIO
NE PTFE 18-22-2 /
GASKET PTFE 18-22-2

986005000:

GRUPPO CIMBALI SPA

9011004:

GRUPPO CIMBALI SPA



2107088 GUARNIZIO
NE TEFLON COLON.NP

/

TEFLON GASKET NP

9111002ex:

GRUPPO CIMBALI SPA

984027000:

GRUPPO CIMBALI SPA



2107154 GUARNIZIO
NE PIATTA IN

SUGHERO /

SEAL FLAT IN CORK

31785:

HOONVED - ALI SPA



2107224 BUSSOLA
GUIDA MOLLA FERMO
PORTA /
GUIDE BUSH SPRING
DOOR STOP

190687:

HOONVED - ALI SPA

190687:

COMENDA ALI SPA



3124167 "PILETTA DI
SCARICO FIL. 1" 1/2" /
DRAIN DRAIN FIL. 1"
"1/2"

25138:

HOONVED - ALI SPA



4115429 GHIERA X
PERNO SCATOLE LAV.
/

UNION SCREW

17565:

HOONVED - ALI SPA



2107206 GUARNIZIO
NE NYLTITE M12 /
GASKET NYLTITE M12

0200295:

LAMBER DI AFFABA
FRANCESCO & C.



2107157 GUARNIZIO
NE 14,5X10X1,5 PTFE /
TEFLON GASKET
14,5X10X1,5



2107162 GUARNIZIO
NE 20X10X1,5 PTFE /
GASKET 20X10X1,5
PTFE



= 1125138

2107172 BUSS.D.14
MOPL.S 3^S PREL.PRER
/

BUSH D.14

190623:

COMENDA ALI SPA



2107208 BUSHING /
BUSHING

228643:

HOBART GmbH



2107196 BUSSOLA
INNESTO MOLLA ST/E /
BUSH FOR SPRING
CONNECTION

190688:

HOONVED - ALI SPA

37449ex:

HOONVED - ALI SPA



3113035 CAMPANA
PRESSOSTATO

33D0360 /

PRESSURE CHAMBER

33D0360

33D0360:

ANGELO PO GRANDI

CUCINE SPA



3113044 ASS.
GABBIA D'ARIA -
Øe=60mm H=38mm /
AIR TRAP ASSEMBLY

206:

ARISTARCO KASTEL

SPA



H=38mm, Øe=60mm

3113019 TRAPPOLA
ARIA

LAVABICCHIERI

COMENDA - Øe=49mm

H=72mm /

GLASS-WASHERS AIR

TRAP COMENDA

161303:

COMENDA ALI SPA

161303:

HOONVED - ALI SPA



H=72mm, Øe=49mm

4115431 TRAPPOLA
ARIA (F-C-AC) G65 /
AIR TRAP (F-C-AC)

G65

161301:

COMENDA ALI SPA



3113012 TRAPPOLA
PRESSOSTATO F45-55-
80 - Øe=44mm

H=110mm /

PRESSURE SWITCH

TRAP F45-55-80

161305:

COMENDA ALI SPA



H=110mm, Øe=44mm

3113027 ASSIEME
GABBIA D'ARIA P646 -
DIMENSION=55X30mm
m H=56mm /
AIR TRAP P646 L=56
DW10911/DEX:
DIHR-ALI SPA
DW135911D:
DIHR-ALI SPA



H=56mm,
DIMENSIONS
55X30mm

3113024 ASSIEME
GABBIA D'ARIA P646 -
DIMENSION=55X30mm
m H=65mm /
AIR TRAP P646 L=65
DW10911C:
DIHR-ALI SPA
DW135911C:
DIHR-ALI SPA



H=65mm,
DIMENSIONS
55X30mm

3113025 ASSIEME
GABBIA D'ARIA 9646 -
DIMENSION=55X31mm
m H=75mm /
AIR TRAP 9646 L=75
DW10911B:
DIHR-ALI SPA
GS40: DIHR-ALI SPA



H=75mm,
DIMENSIONS
55X31mm

3113026 GABBIA
D'ARIA INOX -
Øe=45mm H=89mm /
STAINLESS STEEL
AIR TRAP
DW80106:
DIHR-ALI SPA



H=89mm, Øe=45mm

3113018 TRAPPOLA
ARIA P646 -
DIMENSION=55X31mm
m H=90mm /
AIR TRAP P646 L=90
DW135911:
DIHR-ALI SPA
DW10911ex:
DIHR-ALI SPA



H=90mm,
DIMENSIONS
55X31mm

3113059 GRUPPO
CAMPANA
PRESSOST.35/40 -
Øe=34mm H=78mm /
AIR TRAP 35/40
984005:
ELETTROBAR



H=78mm, Øe=34mm

3113037 TRAPPOLA
ARIA R339 ELETTR -
Øe=34mm H=130mm /

AIR TRAP R339
ELETTROBAR
2517EX: A.T.A. SRL
984002:
ELETTROBAR
7140EX: A.T.A. SRL



H=130mm, Øe=34mm

3113061 TRAPPOLA
ARIA - Øe=50mm
H=87mm /
TRAP AIR
LIB: FABAR SRL
10528EX: FABAR SRL



H=87mm, Øe=50mm

3113040 TRAPPOLA
ARIA LASA -
DIMENSION=45X39mm
m H=95mm /
AIR TRAP LASA
2609680+2187700+:
LASA SRL



H=95mm,
DIMENSIONS
45X39mm

3113060 TRAPPOLA
ARIA 4SA 62P -
Øe=61mm H=110mm /
TRAP AIR 4SA 62P
GP02562PB:
OMNIWASH SRL



H=110mm, Øe=61mm,
GASKET=2101400

3113002 TRAPPOLA
ARIA IME -
DIMENSION=83X33mm
m H=49mm /
AIR TRAP IME
GP025BGR:
OMNIWASH SRL -
SOCIETA' A SOCIO
UNICO



X	Y
W	Z

X= 4115004, Y=2102030,
W= 1141014, Z=2102031,
DIMENSIONS 83X33mm
H=49mm

3113011 TRAPPOLA
ARIA LT -
DIMENSION=83x33mm
H=42mm /
AIR TRAP LT
21002: FABAR SRL
38123007:
RANCILIO
Z100P019:
S.V. ITALIA SRL
9020052:
GRUPPO CIMBALI
SPA
984003000:
GRUPPO CIMBALI
SPA



DIMENSIONS 83x33mm,
H=42mm,
GASKET = 2102056

3113001 TRAPPOLA
ARIA COMPL.
RANCILIO -
DIMENSION=83X33mm
m H=42mm /
COMPLETE AIR TRAP
RANCILIO
15705112:
RANCILIO SPA



DIMENSIONS 83X33mm
H=42mm

3113022 TRAPPOLA
ARIA -
DIMENSION=54X40mm
m H=90mm /
AIR TRAP H=90
907252: **SILANOS**
33M0510:
ANGELO PO GRANDI
CUCINE SPA



DIMENSIONS
54X40mm, H=90mm,
GASKET=2102181

3113010 TRAPPOLA
ARIA SILANOS 1300 -
DIMENSION=53X37mm
m H=130mm /
AIR TRAP SILANOS
1300
TR0268:
SILANOS SRL



DIMENSIONS
53X37mm, H=130mm,
GASKET = 2102181

3113057 GABBIA
D'ARIA - Øe=38mm
H=90mm /
AIR TRAP
20100:
SISTEMA PROJECT
SERVICE SRL



H=90mm, Øe=38mm

3113049 GABBIA
D'ARIA CORTA -
Øe=38mm H=35mm /
AIR TRAP
4032I:
UNIVER-BAR SRL
4032EX:
UNIVER-BAR SRL



H=35mm, Øe=38mm

3113048 GABBIA
D'ARIA LUNGA -
Øe=40mm H=90mm /
AIR TRAP
1360I:
UNIVER-BAR SRL
1360EX:
UNIVER-BAR SRL



H=90mm, Øe=40mm

3113031 TRAPPOLA
ARIA ARISTARCO -
DIMENSION=80X22mm
m H=71mm /
AIR TRAP
ARISTARCO
PASSPORT35.21/38.2
5/40.28/45.30/50.32
/50.35/55.40,6L1040
/124:
ARISTARCO KASTEL
3535:
ARISTARCO KASTEL



A= 1141220B= 2101465,
DIMENSIONS
80X22mm, H=71mm

3113069 CAMPANA
PRESSOSTATO AF 55
AT 900 AL /
AIR CHAMBER AF 55
AT 900 AL
8451: **A.T.A. SRL**



DIMENSIONS 78X26mm
H=65mm

3113005 CAMPANA
PRESSOSTATO AL
NERO -
DIMENSION=84X27mm
m H=80mm /
BLACK PRESSURE
SWITCH BELL AL 80
AL50, AL60, AF73,
AF88, AL05, AL10,
AL26, AL30, AL46,
AL54;
A.T.A. SRL



DIMENSIONS
84X27mm, H=80mm

3113006 CAMPANA
PRESSOSTATO AFAT-
ALP44 -
DIMENSION=84x28mm
H=110mm /
PRESSURE SWITCH
BELL AFAT-ALP44
110h
AL50,
AL60,AF73,AF88:
A.T.A. SRL
4690ex: **A.T.A. SRL**



DIMENSIONS 84x28mm
H=110mm

3113016 TRAPPOLA
ARIA HOONVED -
DIMENSION=84X42mm
m H=50mm /
AIR TRAP HOONVED
161316:
COMENDA ALI SPA
*:
HOONVED - ALI SPA
161316:
HOONVED - ALI SPA



C
A= 2102056, B=2101399,
C= 3113017,
DIMENSIONS
84X42mm, H=50mm

3113052 TRAPPOLA
D'ARIA -
DIMENSION=58X26mm
m H=47mm /
AIR TRAP
048308:
ELECTROLUX
PROFESSIONAL
S.P.A.



DIMENSIONS
58X26mm, H=47mm

3113032 GRUPPO
TRAPPOLA ARIA -
DIMENSION=85X20mm
m H=81mm /
AIR TRAP
11F:
ELETTROBAR
984003:
ELETTROBAR
DIVISIONE DELLA
EUROTEC SRL



DIMENSIONS
85X20mm, H=81mm

3113021 CAMPANA
PRESSOSTATO
ELFRAMO -
DIMENSION=52X31mm
m H=131mm /
AIR TRAP ELFRAMO
C44: **ELFRAMO SPA**



DIMENSIONS
52X31mm, H=131mm

L=120mm, H=60mm,
gasket=2102363

3113058 Z203011000
CAMARA
PRESOSTATO -
DIMENSION=86X20mm
m H=77mm /
AIR TRAP Z203011000
12024350:



DIMENSIONS
86X20mm, H=77mm

FAGOR
INDUSTRIALE S.R.L.

3113007 TRAPPOLA
ARIA HMS/SLNS -
DIMENSION=53X37mm
m H=45mm /
AIR TRAP SILANOS
986055000:
GRUPPO CIMBALI
905273:
SILANOS SRL
9131391:
GRUPPO CIMBALI



DIMENSIONS
53X37mm, H=45mm

3113033 CAMPANA
PRESSOSTATO D30
3/8" Øa=45mm
Øb=37mm H=95mm /
"PRESSURE SWITCH
AIR TRAP D30 3/8" P"
Øa=45mm Øb=37mm
H=95mm
D40: **ELFRAMO SPA**



Øa=45mm, Øb=37mm,
H=95mm

3113054 "CAMPANA
PRESSOSTATO D80F
3/8" ASSIE" Øa=45mm
Øb=37mm H=135mm /
AIR CHAMBER
COMPLETE Ø 45x135
mm
00014087:
ELFRAMO SPA



Øa=45mm, Øb=37mm,
H=135mm,

3113020 TRAPPOLA
ARIA A.PO 33M0220 /
AIR TRAP A.PO
33M0220
33M0220:
ANGELO PO GRANDI
CUCINE SPA



L=120mm, H=60mm,
GASKET=2102900

3113067 TRAPPOLA
ARIA
N45/N50/N90/N1000/N1
300 /
TRAP AIR N45 / N50 /
N90 / N1000 / N1300
907254:
SILANOS SRL



3113023 TRAPPOLA
ARIA BR BC
COMENDA - Øe=34mm
H=126mm /
AIR TRAP BR BC
COMENDA
161310ex:
COMENDA ALI SPA
161324:
COMENDA ALI SPA
161324:
HOONVED - ALI SPA



Øe=34mm, H=135mm

3113046 TRAPPOLA
ARIA FC2006 /
AIR TRAP FC2006
161322:
COMENDA ALI SPA



3113047 TRAPPOLA
D'ARIA P. BOILER /
AIR TRAP 230MM
0L0098:
ELECTROLUX
PROFESSIONAL
S.P.A.



3113064 CAMPANA
PRESSOSTATO (L)
RV40-50-CAPOTE -
L=58mm H=46mm /
AIR TRAP (L) RV40-50-
Capote
*: **ELETTROBAR**
70600: **ELETTROBAR**



L=58mm, H=46mm,
GASKET= 2102540

3113056 RACCORD
O CAMPANA
PRESSOSTATO /
HOSE CONNECTOR
FOR AIR TRAP
468029:
ELETTROBAR
DIVISIONE DELLA
EUROTEC SRL



3113017 RACCORD
O TRAPPOLA ARIA
HOONVED /
AIR TRAP
CONNECTION
HOONVED
161317:
COMENDA ALI SPA
25011:
HOONVED - ALI SPA



= 2101399

3113043 VALVOLA
ANTIRIFLUSSO /
BACK FLOW
RESTRICTOR

1130: A.T.A. SRL
1610: A.T.A. SRL



3113050 KIT
COMPLETO
TRAPPOLA D'ARIA-
KIT ENTIRE AIR
TRAP- Øe=27mm
H=121mm - ØT=8X4mm
L=1120mm / AIR TRAP
KIT

3280: KRUPPS S.R.L.
3288: KRUPPS S.R.L.
3280Kex: KRUPPS
S.R.L.



H=121mm, ØT=8X4mm,
L=1120mm, Øe=27mm

3113063 TUBO PER
TRAPPOLA ARIA
C2001 /
HOSE,PRESS.SW.AIR
TRAP C 2001

161320:
COMENDA ALI SPA
*:

HOONVED - ALI SPA



3113065 Trappola per
aria con tubo - Øe=18mm
H=70mm - ØT=7X4mm
L=930mm /
Trap air with hose

C10537:
BREMA ICE MAKERS
SPA



H=70mm, ØT=7X4mm,
L=930mm, Øe=18mm

3111177 TROPPOIE
NO B 100-200 /
OVERFLOW B 100-200

10275: ADLER S.P.A.
10275: FABAR SRL

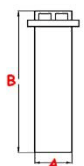

A=25mm, B=92mm

3111210 TROPPOIE
NO 431MM /
OVERFLOW 431MM

33D0050:
ANGELO PO GRANDI
CUCINE SPA

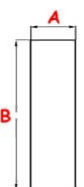

A=42mm, B=431mm,
DRAIN=3124224

3111160 TROPPOIE
NO INOX PROJECT-
GL4.32 /
STAINLESS STEEL
OVER FLOW PROJECT
-GL4.32

2274:
ARISTARCO KASTEL
SPA

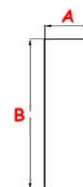

A=28mm, B=110mm

3111074 TROPPOIE
NO PLASTICA /
OVERFLOW PIPE

GL4,32, GL534, GL738:
ARISTARCO KASTEL
PASSPORT
35,21/38,25/40,28/45
.30, PROJET 28:
ARISTARCO KASTEL

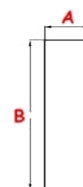

A=30mm, B=110mm

3111225 TROPPOIE
NO INOX PASSPORT
55.40 /
OVERFLOW INOX
PASSPORT 55.40

5669:
ARISTARCO KASTEL
SPA

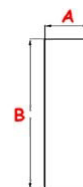

A=35mm, B=130mm

3111094 TUBO
TROPPO PIENO INOX /
STAINLESS STEEL
OVERFLOW

COMPACT20, MASTER
21/22, MINIBARCF/CR
, GEMINICF/CR:
ARISTARCO KASTEL
PROGRAM
25CF/CR, ALISEO422/
428:

ARISTARCO KASTEL



A= 22 mm, B = 135 mm

3111042 TROPPO
PIENO ARISTARCO
50.32 /
OVERFLOW
ARISTARCO 50.32

PASSPORT
50.32/50.35:
ARISTARCO KASTEL
SPA

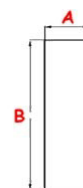

A=35mm, B=140mm

3111226 TROPPOIE
NO AL 350-401-402-410 /
OVERFLOW AL 350-
401-402-410

8452: A.T.A. SRL

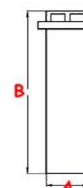

A=27mm, B=99mm

3111032 TROPPO
PIENO LAVABAR /
OVERFLOW LAVABAR
1107: A.T.A. SRL



A = 20mm, B = 120mm

3111007 TUBO
TROPPO PIENO AL
ATA /
BLACK OVERFLOW
PIPE AL ATA
AL10, AL46: A.T.A.
AL10, AL46: A.T.A.

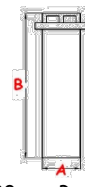

A=30mm, B= 120mm

3111024 TUBO
TROPPO PIENO
C/TAPPO /
OVERFLOW PIPE WITH
CAP
AF83, AT96, AT105,
AT106:
A.T.A. SRL



A= 39mm, B= 175mm

3111008 TROPPOPIE
NO AF ATA /
OVERFLOW AF 9629
ATA
9738: A.T.A. SRL
AF61, AF98:
A.T.A. SRL

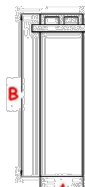

A= 43mm, B= 215mm

3111137 TUBO
TROPPOPIENO ARC /
OVERFLOW PIPE ARC
6903: A.T.A. SRL



A=25mm, B=200mm

3111006 TROPPOPIE
NO AT 9625 ATA /
OVERFLOW AT 9625
ATA
9625EX: A.T.A. SRL
AT96, AT105, AT110,
AT112, AT114, AT116:
A.T.A. SRL

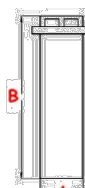

A= 43mm, B=315mm

3111145 TROPP. AF
LIVELLO ALTO
GRIGIO /
OVER FLOW PIPE AF
AF88: A.T.A. SRL

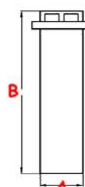

A=40mm, B=320mm

3111221 TAPPO
TROPPO PIENO AF 55 -
AT 900 /
OVERFLOW AF 55 - AT
900
5852: A.T.A. SRL

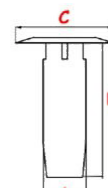

A=43mm B= 126mm,
C= 52mm

3111169 TROPPOPIE
NO AL55 COMPLETO
DI TAPPO /
OVERFLOW PIPE AL55
4134EX: A.T.A. SRL
4157: A.T.A. SRL

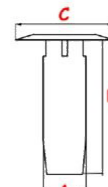

A=39mm, B=130mm,
C=45mm

3111014 TUBO
TROPPOPIENO
C/TAPPO ATA /
OVERFLOW PIPE WITH
CAP ATA
AL50, AL60, AF73,
AF78: A.T.A. SRL



A=39mm, B=155mm,
C=49mm

3111147 TROPPOPIE
ER MICROFILTRO
FC'06 /
OVER FLOW FC'06
170717:
COMENDA ALI SPA

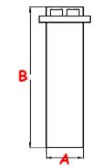

A=33mm ,B=228mm,
GASKET=2102249

3111132 TROPPOPIE
NO FC- H140 /
OVER-FLOW FC H140
170711:
COMENDA ALI SPA

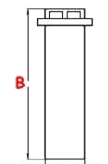

A=35mm, B=150mm,
GASKET 2102106

3111018 TROPPOPIE
NO H 168 "F2-45-55" /
"OVERFLOW H 168
""F2-45-55""
170707:
COMENDA ALI SPA

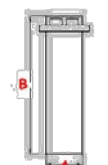

A= 38mm, B= 177mm,
gasket= 2102106

3111044 TROPPO
PIENO LF X BT P.SCAR.
COMENDA /
OVERFLOW LF X BT
COMENDA
170710: COMENDA
170709:
COMENDA ALI SPA

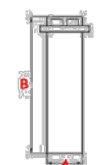

A=37mm, B=177mm

3111071 TROPPO
PIENO H 195 X F3 C30-
C75 /
OVERFLOW H 195 X F3
C30-C75
170708:
COMENDA ALI SPA



3111004 TROPPOPIE
NO MOD. BR-BC /
OVERFLOW MOD. BR-
BC
180716:
COMENDA ALI SPA

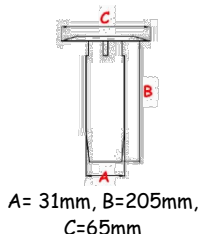

3111073 TROPPO
PIENO H 172,5 C85-140 /
OVERFLOW PIPE
H172,5 C85-140
180708:
COMENDA ALI SPA
33528:
HOONVED - ALI SPA

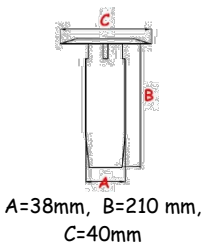

3111107 -TROPPOP.H
198- C34-S90-S3°S. /
OVERFLOW H 198 C34-
S90-S3°S.
180703:
COMENDA ALI SPA

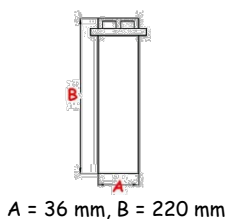

3111118 TROPPOPIE
NO C VASCA PIANA
2001 /
OVERFLOW 2001
180729:
COMENDA ALI SPA
180729:
HOONVED - ALI SPA

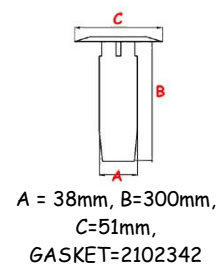

3111076 TROPPOPIE
NO H375 "C155/C95/C16
/
"OVER FLOW H375
""C155/C95/C16"
180715:
COMENDA ALI SPA

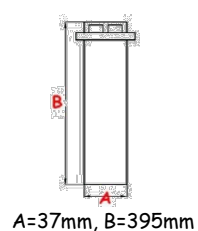

3111207 TROPPOPIE
NO C VASCA SEDIA
2001 / OVERFLOW
TANK CHAIR C 2001
180728:
COMENDA ALI SPA

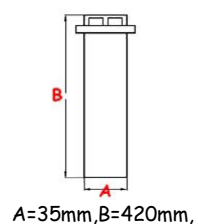

GASKET= 2102342,

3111121 "TROPPOP."
"FC""H140-POMPA
SCARICO" /
OVERFLOW FC H140
170712:
COMENDA ALI SPA



3111047 TROPPO
PIENO BHC COMENDA
/
OVERFLOW PIPE BHC
COMENDA
180724:
COMENDA ALI SPA
35037ex:
HOONVED - ALI SPA
180724:
HOONVED - ALI SPA

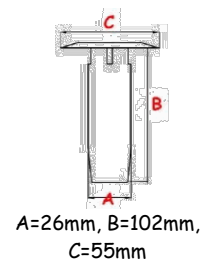

3111138 TROPPOPIE
NO LF2004 (HV36395) /
OVERFLOW PIPE
LF2004 (HV36395)
180730:
COMENDA ALI SPA
36395EX:
HOONVED - ALI SPA
180730:
HOONVED - ALI SPA

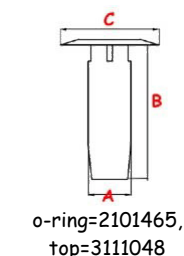

3111108 TROPPOP.E
CORINS
AC/ACR(380863) /
OVERFLOW ECORINS
AC/ACR (380863)
380818:
COMENDA ALI SPA

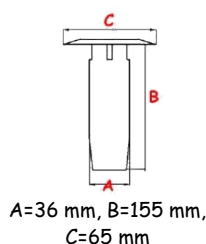

3111046 TROPPO
PIENO H 227 G 131-65-
115 /
OVERFLOW H 227 G
131-65-115
380806:
COMENDA ALI SPA

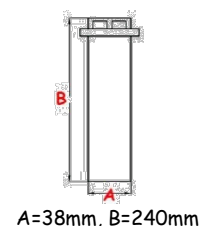

3111198 TROPPOPIE
NO VASCA PRELAV
ACS /
OVERFLOW TANK
PRELAV ACS
380856:
COMENDA ALI SPA



3111202 TROPPOPIE
NO VASCA LAVAGGIO
ACS /
OVERFLOW WASHING
TANK ACS
380857:
COMENDA ALI SPA

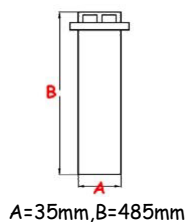

A=35mm, B=485mm

3111075 TRAPPOLA
ARIA PRESS. C95/155 /
PRESSURE SWITCH
AIR TRAP C95/155
161308ex:
COMENDA ALI SPA
161323:
COMENDA ALI SPA



3111070 TROPPO
PIENO SERIE GS35-37
SERIE 99 /
OVERFLOW PIPE GS35-
37 / 99
DW135252:
DIHR-ALI SPA

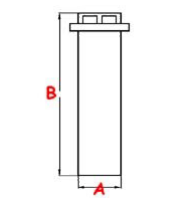

A = 27 mm, B = 91 mm

3111061 TROPPOPIE
NO SERIE 35/37 /
OVERFLOW SERIES
35/37
DW135252:
DIHR-ALI SPA
DW135251:
DIHR-ALI SPA

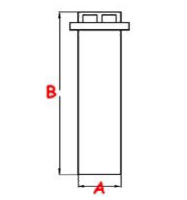

A=26mm, B=96mm

3111059 TROPPOPIE
NO LINEAR GS40 C40 /
OVERFLOW LINEAR
GS40 C40
DW16052:
DIHR-ALI SPA

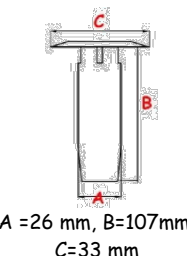

A = 26 mm, B=107mm,
C=33 mm

3111062 TROPPOPIE
NO VERS. 600 PS H=120
/
OVERFLOW VERS. 600
PS H=120
DW150320:
DIHR-ALI SPA

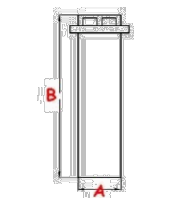

A=28mm, B=120mm

3111049 TROPPOPIE
NO GASTRO 450/500
L=132 /
OVERFLOW GASTRO
450/500 L=132
DW15126:
DIHR-ALI SPA

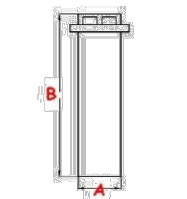

A=28mm, B=132mm

3111060 TROPPOPIE
NO DIS.L3044 L=140 /
OVERFLOW DIS. L3044
L=140
DW10725:
DIHR-ALI SPA
DW10300005:
DIHR-ALI SPA

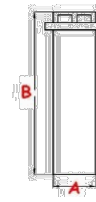

A=28mm, B=140mm

3111068 TROPPO
PIENO MOD LP1/800 /
OVERFLOW MOD
LP1/800
DW22251:
DIHR-ALI SPA

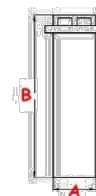

3111055 ASSIEME
TROPPO PIENO H 187
C/TAPPO /
OVERFLOW H187
WITH CAP
DW500618:
DIHR-ALI SPA

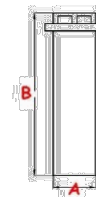

A=40 mm, B=187 mm,
gasket=2102239

3111056 ASSIEME
TROPPO PIENO H213
C/TAPPO /
OVERFLOW H213
WITH CAP
TEKNO6:
DIHR-ALI SPA

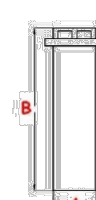

A=40mm, B=210mm,
gasket=2102239

3111057 ASSIEME
TROPPO PIENO H 200
C/TAPPO /
OVERFLOW H 200
WITH CAP
DW540033:
DIHR-ALI SPA

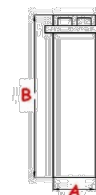

A=40mm, B=200mm,
GASKET=2102239

3111058 TROPPO
PIENO C/TAPPO
D'ARIA TEKNO 6 /
OVERFLOW WITH AIR
CAP TEKNO 6
DW560020:
DIHR-ALI SPA

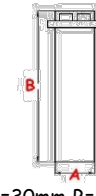

A=30mm B=210mm

3111197 TROPPOPIE
NO /
OVERFLOW
DW11600102:
DIHR-ALI SPA

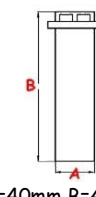

A=40mm, B=420mm,
GASKET=2102239

3111189 TROPPOIE
NO /
OVERFLOW
GS35-GS37:
DIHR-ALI SPA

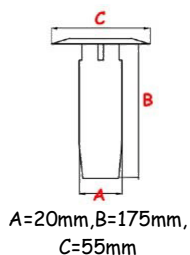

3111066 TROPPOIE
NO 1000 TIPO
VECCHIO /
OVERFLOW 1000 OLD
STYLE
DW22018:
DIHR-ALI SPA

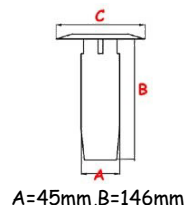

3111067 TROPPO
PIENO PER 11 S /
OVERFLOW FOR 11S
DW75250:
DIHR-ALI SPA

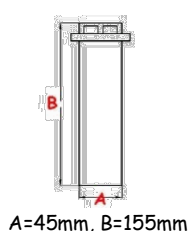

3111063 FINALE PER
TROPPO PIENO G 12S
DIHR /
FINAL FOR
OVERFLOW G 12S
DIHR
DW11600019:
DIHR-ALI SPA

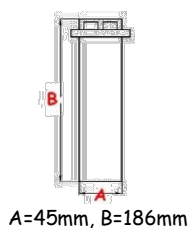

3111219 TUBO
TROPPOPIENO
/ OVERFLOW PIPE
049195:
ELECTROLUX
PROFESSIONAL
S.P.A.

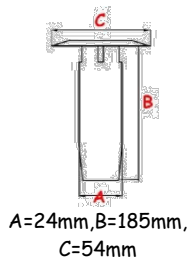

3111166 TUBO
TROPPOPIENO /
OVER FLOW
049194:
ELECTROLUX
PROFESSIONAL
S.P.A.

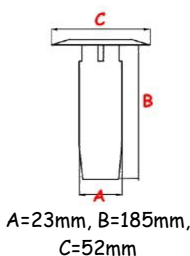

3111222 TUBO
TROPPOPIENO ϕ 26x277
mm /
OVERFLOW PIPE ϕ
26x277 mm
048842:
ELECTROLUX

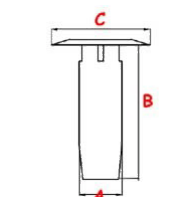

PROFESSIONAL
S.P.A.

A=26mm, B= 271mm,
C= 39mm

3111034 TROPPO
PIENO 048323 /
OVERFLOW 048323
048323:
ELECTROLUX
PROFESSIONAL
S.P.A.

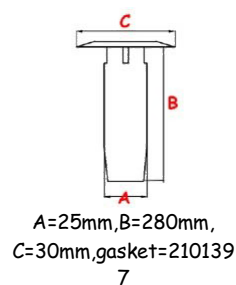

3111181 TUBO
TROPPOPIENO /
OVERFLOW
048250:
ELECTROLUX
PROFESSIONAL
S.P.A.

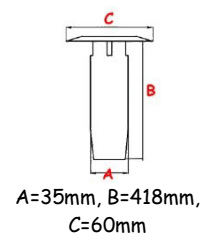

3111211 TAPPO
TROPPO PIENO /
CAP OVERFLOW
049675:
ELECTROLUX
PROFESSIONAL
S.P.A.

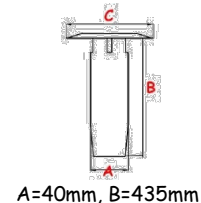

3111082 TROPPO
PIENO
LAVABICCHIERI
ELETTROBAR /
GLASS WASHER
OVERFLOW
ELETTROBAR
142014:
ELETTROBAR

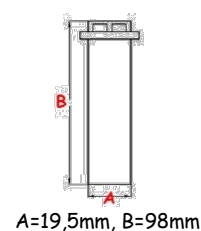

3111165 TROPPOIE
NO PER POMPA DI
SCARICO 50/503 /
DRAIN PUMP OVER
FLOW 50/503
142053:
ELETTROBAR
DIVISIONE DELLA
EUROTEC SRL

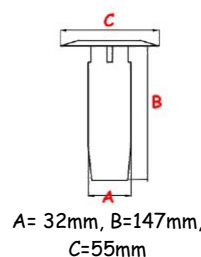

3111096 TROPPOIE
NO PER
LAVASTOVIGLIE /
OVERFLOW
142052:
ELETTROBAR
DIVISIONE DELLA
EUROTEC SRL

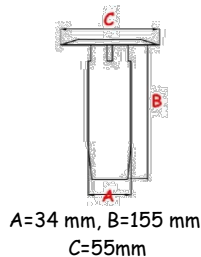

3111072 TROPPOPIE
NO PER
LAVABICCHIERI /
OVERFLOW PIPE
142038:
ELETTROBAR
DIVISIONE DELLA
EUROTEC SRL

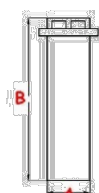

A = 20 mm, B = 153 mm

3111122 TROPPOPIE
NO PER
LAVABICCHIERI /
OVERFLOW PIPE FOR
TYPE 40
142034:
ELETTROBAR
REB142034:
LOTUS SPA
REB142034: COLGED
D142034:
GIGA GRANDI
CUCINE SRL
*: MBM- EUROTEC
SRL - DIV. COOKING
SERVICE

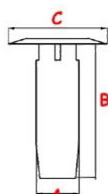

A=22mm , B=163mm,
C=47mm

3111102 TROPPOPIE
NO E.35/40 /
OVERFLOW PIPE 35/40
E40:
ELETTROBAR
DIVISIONE DELLA
EUROTEC SRL

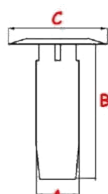

A=21mm, B=170mm,
C=40mm

3111031 TROPPO
PIENO 21/31
ELETTROBAR /
OVERFLOW 21/31
ELETTROBAR
142008:
ELETTROBAR
DIVISIONE DELLA
EUROTEC SRL

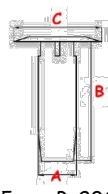

A= 25mm, B=206mm,
C=48mm,gasket=210139
1

3111023 TROPPO
PIENO R706-8/S870 /
OVERFLOW R706-
8/S870
142010:
ELETTROBAR
DIVISIONE DELLA
EUROTEC SRL

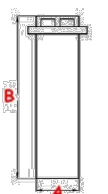

A=36,5mm, B=200mm

3111126 TROPPO
PIENO RIVER 8081 /
OVERFLOW RIVER
8081
*:
MBM- EUROTEC SRL -
DIV. COOKING
SERVICE
80249:
ELETTROBAR

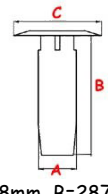

A=38mm ,B=287mm,
gasket=2101569

3111151 TROPPOPIE
NO IN PLASTICA PER
LAVASTOVIGLIE /
OVER FLOW PIPE
*:
MBM- EUROTEC SRL -
DIV. COOKING
SERVICE
926046:
ELETTROBAR

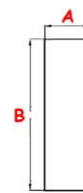

A=34mm, B=390mm

3111130 TROPPOPIE
NO IN PLASTICA PER
LAVASTOVIGLIE /
OVERFLOW
927058:
ELETTROBAR



3111144 TROPPOPIE
NO /
OVER FLOW
142022:
ELETTROBAR
DIVISIONE DELLA
EUROTEC SRL
S59: COLGED

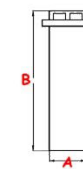

A=39mm, B=240mm,
GASKET=2102569

3111127 TROPPO
PIENO X5 /
OVERFLOW X5
142054:
ELETTROBAR
DIVISIONE DELLA
EUROTEC SRL



3111097 TROPPO
PIENO 66 /
OVERFLOW 66
142024:
ELETTROBAR
DIVISIONE DELLA
EUROTEC SRL



A = 40 mm, B = 230 mm

3111080 TAPPO
TROPPOPIENO BD11-13
/
OVERFLOW CAP BD11
BD11-BD13-:
ELFRAMO SPA

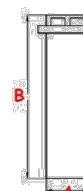

A=43,5mm, B=130mm,
gasket= 2102255

3111120 TAPPO
TROPPOPIENO BD14 /
OVERFLOW BD14
BD14: ELFRAMO SPA

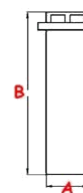

A =29mm,B=185mm,
gasket= 2102255

3111111 TAPPO
TROPPOPIENO
ELFRAMO D30 /
OVERFLOW ELFRAMO
D30

D30, BD22-d40:
ELFRAMO SPA



A = 43,5mm, B = 195mm,
gasket=2102255

3111193 TAPPO
TROPPOPIENO D30
C/PS /
OVERFLOW PIPE D30
C/PS

00013839:

ELFRAMO SPA



A=43,5mm, B=195mm,
gasket=2102255

3111119 TAPPO
TROPPOPIENO D80F /
OVERFLOW D80F

00014074:

ELFRAMO SPA



A=43,5mm, B=245mm,
gasket= 2102255

3111109 TAPPO
TROPPOPIENO C44
VASCA STAMP. /
OVERFLOW PIPE C44

c44-c66-c34:

ELFRAMO SPA

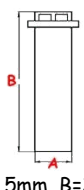

A=43,5mm, B=315mm,
gasket= 2102255

3111113 TAPPO
TROPPOPIENO LP60 /
OVERFLOW LP60

00065554:

ELFRAMO SPA

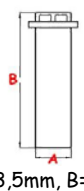

A = 43,5mm, B=350mm
gasket= 2102255

3111035 TROPPOPIE
NO X MOD. LQ10 /
OVERFLOW FOR MOD.
LQ10

03028F: FABAR SRL



A=31mm, B=80mm

3111175 Z200909000

TROPPOPIENO /
Z200909000
OVERFLOW

12024323:

FAGOR

INDUSTRIALE

FI48:

FAGOR

INDUSTRIALE

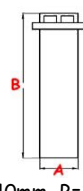

A=40mm, B=177mm

3111176 Z400907000

TROPPOPIENO /
Z400907000
OVERFLOW

12025249:

FAGOR

INDUSTRIALE.

Z400907000EX:

FAGOR

INDUSTRIALE

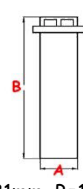

A=21mm, B=165mm,
gasket=2101857,

3111005 TROPPOPIE

NO SB-C-R-A-GB-GR
H92 /

OVERFLOW SB-C-R-A-
GB-GR H92

984037000:

GRUPPO CIMBALI

SPA

907280: SILANOS

SRL

38123472:

RANCILIO SPA

9141500:

GRUPPO CIMBALI

SPA

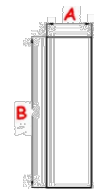

A=24mm, B=93mm

3111188 TROPPO

PIENO FABBRICATORE
DI GHIACCIO /
OVERFLOW TUBE

889125051:

GRUPPO CIMBALI

SPA

66069801:

SCOTSMAN ICE SRL

66069801: SIMAG

SPA

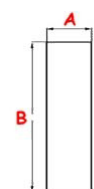

A=17mm, B=53mm

3111104 TROPPO

PIENO ACC. INOX. P 60

E /

STAINLESS STEEL

OVERFLOW P 60 E

9131130:

GRUPPO CIMBALI

SPA

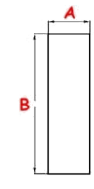

A=30mm, B=115mm

3111106 TROPPO

PIENO SILENT /

OVERFLOW SILENT

9131705:

GRUPPO CIMBALI

SPA

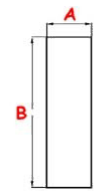

A=27mm, B=134mm

311105 TROPPO
PIENO ACC.INOX.NP 80

/
STAINLESS STEEL
OVERFLOW NP 80

9131207:

GRUPPO CIMBALI
SPA

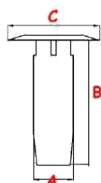

A=40mm, B=210mm,
C=50mm

3111227 PIPE
OVERFLOW /
PIPE OVERFLOW

2294262V:

HOBART GmbH

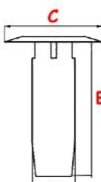

A=50mm, B= 385mm,
C=110mm

3111083 TUBO
TROPPOPIENO S/E 42 /
OVERFLOW S/E 42

25013:

HOONVED - ALI SPA



A=34 mm, B=88 mm,
C=36mm

3111025 TUBO
TROPPOPIENO C 43/48 /
OVERFLOW PIPE C
43/48

33735:

HOONVED - ALI SPA

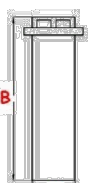

A=35mm, B=123mm

3111110 TUBO
TROPPOPIENO TS-48 /
OVERFLOW TS-48

25012:

HOONVED - ALI SPA

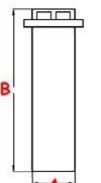

A=35mm, B=143mm

3111041 TROPPO
PIENO 43-48 HOONVED

/
OVERFLOW 43-48
HOONVED

21078R:

HOONVED - ALI SPA

30423+30424+3047:

HOONVED - ALI SPA

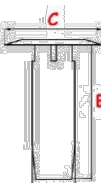

A= 27mm, B=100mm,
C=69mm

3111086 TROPPO
PIENO PREM. 53-60 /
OVERFLOW 53-60

21286/R:

HOONVED - ALI SPA

21286Rex:

HOONVED - ALI SPA

21286:

HOONVED - ALI SPA

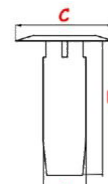

A= 27mm, B=110mm,
C=69mm

3111192 TUBO
TROPPOPIENO CPL
STS-C 60 /
OVERFLOW CPL STS-C
60

18903:

HOONVED - ALI SPA

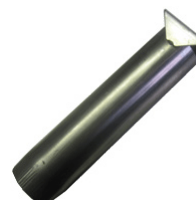

A=36mm, B=149mm,
C=44mm

3111084 TROPPOPIE
NO C7STS60 H=157 /
OVERFLOW C/DTS60
H=157

34485:

HOONVED - ALI SPA

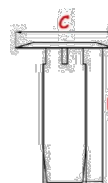

A = 40 mm, B=160 mm,
C=44 mm

3111163 TROPPOPIE
NO
IMB.650PREM.L=260 /
OVERFLOW PIPE
L=260

20924:

HOONVED - ALI SPA

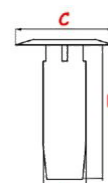

A=40mm, B=260mm,
C=168mm

3111150 TROPPOPIE
NO PREM. ED700-900 /
OVER FLOW ED700-900

21521/R:

HOONVED - ALI SPA

21521:

HOONVED - ALI SPA

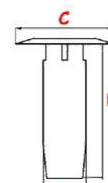

3111148 TUBO
TROPPO PIENO Ø25
MM - TOO FULL™ PIPE
Ø25 MM /
OVER FLOW Ø25 MM

1123: KRUPPS S.R.L.

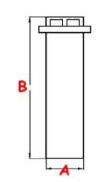

A=25mm, B=110mm

3111205 TROPPOPIE
NO LAVASTOVIGLIE /
OVERFLOW

104460: KRUPPS S.R.L.

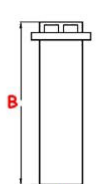

A=35mm, B=180mm

3111149 TUBO
TROPPO PIENO INOX
Ø40 MM /
OVER FLOW Ø40 MM
800101: KRUPPS S.R.L.

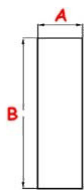

A=40mm, B=105mm

3111168 TROPPO
PIENO INOX Ø40 MM /
INOX OVERFLOW Ø40
MM
1201091: KRUPPS
S.R.L.

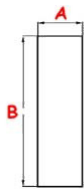

A=40mm, B=120mm

3111201 TROPPO
PIENO INOX D.40 PER
MOD.ES50 /
OVERFLOW STEEL
D.40 MOD.ES50
ES50002:
KRUPPS S.R.L.



3111218 TROPPO
PIENO SUPERQS /
OVERFLOW SUPERQS
0204007: LAMBER
SRL

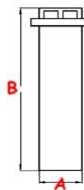

A=28mm, B=176mm

3111033 TROPPOPIE
NO LB/360-Z-91-2-4
LASA /
OVERFLOW LB/360-Z-
91-2-4 LASA
6420170: LASA SRL
6420180: LASA SRL



A=26 mm, B=87mm

3111140 TROPPO
PIENO MOD K1300 /
OVER FLOW MOD
K1300
L3055: LUXIA SRL



A= 35mm, B= 250mm

3111199 TU.T/PIENO
S/SERV.T.N.3600076
D.20 /
OVERFLOW
V.T.N.3600076 D.20
RIC0002700:
MBM- EUROTEC SRL -
DIV. COOKING
SERVICE

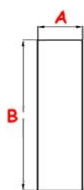

3111172 TUBO
TROPPOPIENO Ø
32X195 MM /
OVERFLOW PIPE D.
32X195 MM
41203500ex:
MODULAR SPA
41028300:
MODULAR SPA

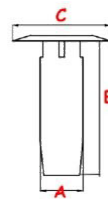

A=32mm, B=203mm,
C=55mm

3111003 TROPPO
PIENO 1-2 IME /
OVERFLOW 1-2 IME
GS116CC:
OMNIWASH SRL -
GS116CCAB:
OMNIWASH SRL
GS116CCABGR:
OMNIWASH SRL -
SOCIETA' A SOCIO
UNICO

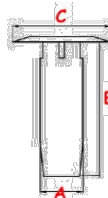

A= 25mm, B=102mm,
C=59mm

3111095 TROPPO
PIENO MOD. 4SA PPL
STAMPO 100 UNI /
OVERFLOW MOD. 4SA
PPL 100 UNI
GSSA16PLB:
OMNIWASH SRL -
SOCIETA' A SOCIO
UNICO



A = 32 mm, B=155 mm,
C=44 mm

3111029 TROPPO
PIENO 4T-4/82
COMPLETO /
COMPLETE
OVERFLOW 4T-4/82
GS416CCABGR:
OMNIWASH SRL
GS416CC:
OMNIWASH SRL

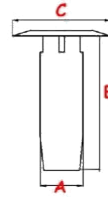

A = 30mm, B = 170mm,
C= 60mm

3111028 TROPPO
PIENO CAPOTTA PPL
IME /
OVERFLOW HOOD PPL
IME
GS6013BGR:
OMNIWASH SRL -
SOCIETA' A SOCIO
UNICO
GS6013:
OMNIWASH SRL -
SOCIETA' A SOCIO
UNICO



A=35mm, B=190mm,
C=43mm

3111001 TROPPOPIE
NO H92 D23 /
OVERFLOW 112mm
LT11/110
38124005:
RANCILIO SPA
38124055ex:
RANCILIO SPA

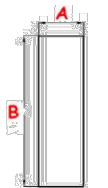

A=23mm, B= 93mm

3111002 TROPPO
PIENO MM116
RANCILIO /
OVERFLOW 116mm
RANCILIO
38124034:
RANCILIO SPA



A=23mm, B=116mm

3111027 TROPPO
PIENO MM133 /
OVERFLOW MM133
38124023:
RANCILIO SPA

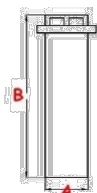

A=30mm, B= 133mm

3111052 TROPPO
PIENO POMPA
SCARICO MM133 /
DRAIN PUMP
OVERFLOW MM133
38124042:
RANCILIO SPA



A=30mm, B=133mm

3111054 TROPPO
PIENO LS 1105 /
OVERFLOW LS 1105
30002024:
RANCILIO SPA

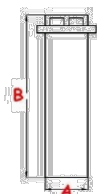

3111170 TROPPOPIE
NO SV21 /
OVERFLOW SV21
2307517: SAMMIC

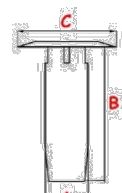

A=32mm, B=170mm,
C=42mm

3111030 TROPPO
PIENO 700 SILANOS
COMPLETO DI
PILETTA /
OVERFLOW WITH
JUNCTION 700
SILANOS
905246*:
SILANOS SRL
907310ex:
SILANOS SRL

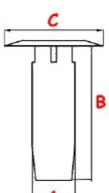

A=31mm, B=112mm,
C=34mm,
piletta=3124193,
oring=2101465

3111020 TROPPO
PIENO V40 V45 V50
135H /
OVERFLOW V40 V45
V50 135H
907282: SILANOS
SRL

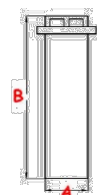

A= 26mm, B= 150mm

3111139 TROPPO
PIENO 217MM
N45/50/90 MOPLEN /
OVERFLOW PIPE
217MM N45/50/90
MOPLEN
907303: SILANOS
SRL

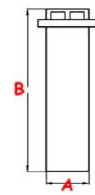

A=30mm,B=220mm

3111038 TROPPO
PIENO 1300 H 245 1300 /
OVERFLOW 1300 H 245
1300
907329: SILANOS
SRL

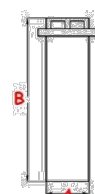

A=33mm, B=240mm

3111204 TROPPO
PIENO 285mm N1300 /
OVERFLOW 285mm
N1300
907338: SILANOS
SRL
907340: SILANOS
SRL

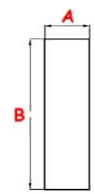

B=285mm, A=35mm

3111230 TROPPO
PIENO H154 SERIE S /
OVERFLOW H154 -
SERIES S
902274: SILANOS
SRL

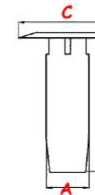

A=20mm,B=150mm,
C=30mm

3111208 TROPPO
PIENO H159 SERIE S/E /
OVERFLOW H159
SERIES S / E
902276: SILANOS
SRL

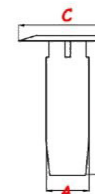

A=20mm,B=159mm,
C=30mm,

3111223 TROPPO
PIENO 165mm
N750/N750PS MOPLEN
T /
OVERFLOW 165mm
N750 / N750PS MOPLEN
T
905248: SILANOS
SRL

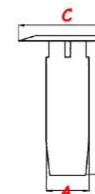

A=31mm,B=174mm,
C=34mm,

3111088 TROPPO
PIENO 1000 H=190 /
OVERFLOW 1000
H=190
907336: **SILANOS**
SRL



A = 34 mm, B = 190 mm

3111194 TROPPO
PIENO 325mm PREL.N
V.T. /
OVERFLOW 325mm
TR1024: **SILANOS**
SRL



A=32mm, B=325mm

3111185 TROPPO
PIENO 325MM INOX
PREL. /
OVERFLOW 325MM
INOX
TR1039: **SILANOS**
SRL



A=35mm, B=325mm

3111195 TROPPOPIE
NO /
OVERFLOW
453309: **TEIKOS** SRL

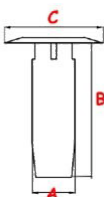

A=38mm, B=75mm,
C=48mm

3111157 TROPPOPIE
NO MIX/TOP /
OVER FLOW MIX/TOP
3266:
UNIVER-BAR SRL



A=28mm, B=88mm

3111158 TROPPOPIE
NO
BET37/BET40/ERGON/
MIDI40/SINCRO /
OVER FLOW
BET37/BET40/ERGON/
MIDI40/SINCRO
1534:
UNIVER-BAR SRL



A=28mm, B=106mm

3111156 TROPPOPIE
NO
MIDI50/LOGOS/OMEG
A /
OVER FLOW
MIDI50/LOGOS/OMEG
A
2112: **UNIVER-BAR**
SRL



A=28mm, B=121mm

3111162 TROPPOPIE
NO COSMO/COMPACT
/
OVER FLOW
COSMO/COMPACT
1201: **UNIVER-BAR**
SRL

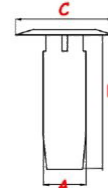

A=48mm, B=150mm,
C=52mm

3111143 TROPPOPIE
NO 1"1/2 mm190 LP650-
800-1200 /
"OVER FLOW 1"1/2
mm190 LP650-800-1200"
01707197:
VELOX BARCHITTA
S.R.L.

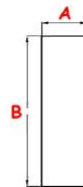

A= 39mm, B=190mm

3111026 TROPPOPIE
NO WINTERHALTER /
OVERFLOW
WINTERHALTER
61004192:
WINTERHALTER
ITALIA SRL



A=37mm, B=215mm

3111048 COPERCHIO
TROPPO PIENO BHC /
OVERFLOW COVER
BHC
180725:
COMENDA ALI SPA
30424EX:
HOONVED - ALI SPA
180725:
HOONVED - ALI SPA



3111087 TAPPO PER
TROPPO.S2900 NG /
OVERFLOW CAP S2900
NG
160738:
COMENDA ALI SPA



3111224 TAPPO
TROPPOPIENO
PRELAVAGGIO AC-
ACR /
OVERFLOW
PREWASHING AC-ACR
160777:
COMENDA ALI SPA

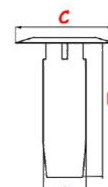
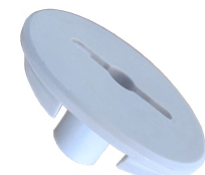

A=19mm, B=25mm,
C=73mm

3111098 TAPPO
TROPPO PIENO /
OVERFLOW CAP
480019:
ELETTROBAR
DIVISIONE DELLA
EUROTEC SRL



3111206 ASSIEME
TROPPOPIENO CON
TAPPO ED OR /
ASSEMBLY
OVERFLOW WITH
PLUG AND OR
K01317:
ARISTARCO KASTEL
SPA

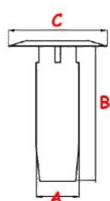

A=21mm, B=95mm,
C=40mm

3111040 ASSIEME
TUBO TROPPOPIENO /
OVERFLOW PIPE
C10133:
BREMA ICE MAKERS
SPA

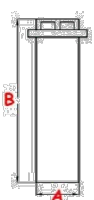

A=21mm, B=91mm

3111092 TUBO
TROPPOPIENO CB184 /
OVERFLOW CB184
13028:
BREMA ICE MAKERS
SPA

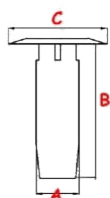

A=19mm, B=145mm,
C=26mm

3111131 TUBO
TROPPO PIENO /
OVERFLOW PIPE
10133:
BREMA ICE MAKERS
SPA

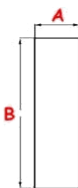

A=18mm, B=87mm,
OR=2101173,
DRAIN=4114172,
NUT=4114170,
GASKET=2101301

3111128 TUBO
TROPPO PIENO /
OVERFLOW
10399:
BREMA ICE MAKERS
SPA

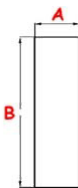

A=21mm, B=113mm

3111154 RACCORDO
SCARICO
TROPPOPIENO KL-KD3
/
OVER FLOW DRAIN
CONNECTION KL-KD3
2CLO08: MIGEL S.R.L.

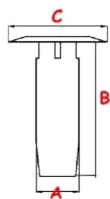

A=18mm, B=120mm,
C=45mm

3111216 OVERFLOW
TUBE /
OVERFLOW TUBE
66060100:
SCOTSMAN ICE SRL

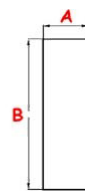
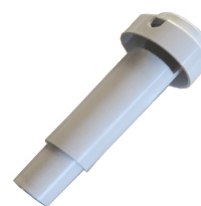

A=20mm, B=111mm

3111190 TAPPO
TROPPO PIENO /
OVERFLOW TUBE
66069802:
SCOTSMAN ICE SRL

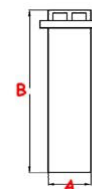

A= 19 mm, B= 70 mm

3111037 TROPPOPIE
NO SIMAG /
OVERFLOW SIMAG
66038705:
SCOTSMAN ICE SRL



A = 25 mm, B = 105 mm

3111167 OVERFLOW
TUBE /
OVERFLOW TUBE
66069800:
SCOTSMAN ICE SRL



3111123 OVERLOAD
/
OVERLOAD
1800871150:
SCOTSMAN ICE SRL



3111155 RACCORDO
TROPPOPIENO 3/8"
COMPL. DI DADO /
OVER FLOW 3/8



3124035 PILETTA
SCARICO /
DRAIN JUNCTION
32:
ARISTARCO KASTEL
SPA



GASKET=2102435,
NUT=1141331

3124252 PILETTA
COD.32 ALESATA
SERIE LP /
JUNCTION COD.32 LP
SERIES
5027:
ARISTARCO KASTEL
SPA



3124079 PILETTA
SCARICO ARISTARCO
G3/4 /
DRAIN PIPE
ARISTARCO G3/4
MINBARCF/CR,
COMPACT20,
MASTER 21/22:
ARISTARCO KASTEL
SPA
ALISEO
422/428,PROGRAM
25CF/CR,GEMINI
CF/CR:
ARISTARCO KASTEL
SPA



nut=3124080,
gasket=2101563

3124020 PILETTA
SCARICO /
HOSE CONNECTOR
1072: A.T.A. SRL



3124002 PILETTA
PLASTICA COMPL. DI
GHIERA E GUARN. /
COMPLETE DRAIN
PLUG
7151+7152: A.T.A. SRL
6860: A.T.A. SRL



3124071 PIPA
SCARICO 11
ELETTROBAR /
DRAIN PIPE 11
ELETTROBAR
463008:
ELETTROBAR
DIVISIONE DELLA
EUROTEC SRL



3124194 GRUPPO
SCARICO /
DRAIN PLUG
ASSEMBLY
999067:
ELETTROBAR
DIVISIONE DELLA
EUROTEC SRL



3124082 PILETTA
CURVA SCARICO /
DRAIN JUNCTION
136023:
ELETTROBAR
DIVISIONE DELLA
EUROTEC SRL



3124037 PILETTA DI
SCARICO A 90° /
DRAIN JUNCTION 90°
32716:
HOONVED - ALI SPA



3124172 PILETTA DI
ASP.POMPA 90° /
INTAKE BODY
BOTTOM
32715:
HOONVED - ALI SPA

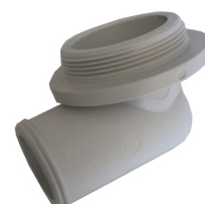

3124143 GOMITO
RACCORDO PLAST. 1"
- PLASTIC ELBOW
JOINT 1" /
"DRAIN VALVE
ELBOW 1" HOSE
CONNECTOR ? 25mm"
1130: KRUPPS S.R.L.



3124007 RACCORDO
SCARICO IME /
DRAIN JUNCTION IME
6S121GR:
OMNIWASH SRL -
SOCIETA' A SOCIO
UNICO



3124140 RACCORDO
DI SCARICO /
DRAIN ELBOW
4368: A.T.A. SRL



3124072 CODOLO
CURVO 1"1/2" SCAR.
N-S-F- /
"KNEE 1 1/2"
NSFC/OUTFLOW"
160203:
COMENDA ALI SPA



3124174 GOMITO
PILETTA TUBO ASP.
D=28 B11 /
DRAIN PLUG ELBOW
D=28MM B11
00211026:
ELFRAMO SPA



3124176 GOMITO
PILETTA TUBO SC.
D=28 /
DRAIN PLUG ELBOW
D=28
00211035:
ELFRAMO SPA



3124187 GOMITO
PILETTA TUBO ASP.
D=50 /
ELBOW DRAIN HOSE
D50
00012702:
ELFRAMO SPA

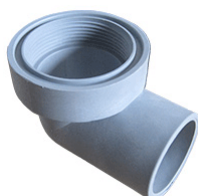

3124099 GOMITO
PILETTA TUBO SC. /
INTAKE BODY
C44,C66,C77:
ELFRAMO SPA



3124019 RACCORDO
DI SCARICO LUNGO /
DRAIN JOINT
190225:
COMENDA ALI SPA
30421ex:
HOONVED - ALI SPA
190225:
HOONVED - ALI SPA



o-ring= 2101410,
= 3124060

3124089 PILETTA
ENTRATA CQ 1-2
BIANCA STAMPO 132
UNI /
ANGLE PIECE FOR
WASH ARM HOLDER
CQ 1-2
LI126FCBGR:
OMNIWASH SRL -
SOCIETA' A SOCIO
UNICO



ORING=2101402,
NUT=1141063

3124083 RACCORDO
SCARICO 3-4 /
ANGLE PIECE 3-4
977011000:
GRUPPO CIMBALI
SPA
GS321BGR:
OMNIWASH SRL -
SOCIETA' A SOCIO
UNICO



3124084 PILETTA
ENTRATA CQ4 /
ANGLE PIECE CQ4
LI430FCBGR:
OMNIWASH SRL -
SOCIETA' A SOCIO
UNICO



4115244 GOMITO
ASPIRAZIONE/SCARIC
O /
HOSE ELBOW
20090:
SISTEMA PROJECT
SERVICE SRL



3124170 "PILETTA
SCARICO 1""G." /
DISCHARGE FITTING 1
"" G. "
1536:
UNIVER-BAR SRL



GASKET=2102241

3124224 PILETTA
TROPPOPIENO /
DRAIN OVERFLOW
33Q3050:
ANGELO PO GRANDI
CUCINE SPA



3124001 PILETTA DI
SCARICO 4122 ATA /
DRAIN JUNCTION 4122
ATA
4122: A.T.A. SRL



gasket=2102266,
gasket=2102048,
nut=3124171, drain
pipe=4115418

3124038 PILETTA
SCARICO 1 1/2 INOX G
COMENDA /
"DRAIN JUNCTION
1 1/2 STAINLESS
STEEL G COMENDA"
270408:
COMENDA ALI SPA



3124110 "PILETTA
SCARICO
ECOR.D.1 1/2" - ø 68
mm - /
"WASTE DISCHARGE
ECOR.D.1 1/2" - ø 68
mm -
270406:
COMENDA ALI SPA



DIMENSION = 1 1/2" -
ø 68 mm -

3124213 "PILETTA
SCAR.1 1/2 AC-ACR-
NE" /
DRAIN FITTING 1 1/2
AC-ACR-NE".
270409:
COMENDA ALI SPA

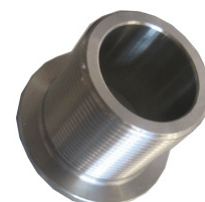

3124154 "KIT
PILETTA INOX 1 1/2
(1360-1363)" /
"DRAIN JUNCTION
1 1/2 (1360-1363)"
1360K: KRUPPS S.R.L.



3124153 PILETTA
SCARICO
COSMO/COMPACT /
DRAIN JUNCTION
COSMO/COMPACT

4621:
UNIVER-BAR SRL



3124139 PILETTA DI
SCARICO 1"1/2
C/CROCIERA FISSA
LP1200 C/GUARN. /
"DRAIN JUNCTION
1"1/2"

01701007:
VELOX BARCHITTA
S.R.L.



3124198 PILETTA DI
SCARICO DA 1/2"
LUNGHEZZA MM.16
FLANGIA DRITTA /
DRAIN PLUG 1/2"
LENGTH 16MM



3124188 PILETTA
1"1/4 CON FILETTO
INTERNO /
DRAIN PLUG 1"1/4



3124080 DADO
PILETTA SCARICOG3/4
(079) /
NUT FOR DRAIN
JUNCTION G3/4 (079)

PROGRAM25CF/CR,
ALISEO 422/428:
ARISTARCO KASTEL
SPA
MINIBAR
CF/CR,COMPACT 20,
MASTER 21/22,
GEMINI CF/CR:
ARISTARCO KASTEL
SPA

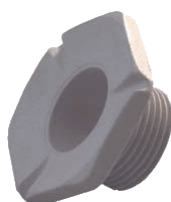

3124148 GHIERA
FISSAGGIO PILETTA
SCARICO /
DRAIN VALVE

1071: A.T.A. SRL



3124050 PILETTA
ASPIRAZIONE NE
POMPA BHC /
PUMP SUCTION PILE
NE BHC

160310:
COMENDA ALI SPA



30425: HOONVED

3124081 PILETTA
ASPIRAZIONE FC ° /
PUMP INLET HOSE FC

160308:
COMENDA ALI SPA



3124067 PILETTA
SCARICO 1 1/2"C /
"DRAIN JUNCTION 1
1/2"C"

160301:
COMENDA ALI SPA
160301:
HOONVED - ALI SPA



3124052 PILETTA X
POMPA SCARICO FC /
DRAIN PUMP
JUNCTION FC

160307:
COMENDA ALI SPA



3124237 GHIERA
INNESTO FILTRI
MOD.50 2004 /
RING NUT WITH
FILTER COUPLING

DW500607:
DIHR-ALI SPA



D. filetto/
Thread diameter 74mm

3124228 RACCORDO
SCARICO /
DRAIN FITTING

070328:
ELECTROLUX
PROFESSIONAL
S.P.A.



3124178 "PILETTA
SCARICO IN
PLASTICA DA 1"1/4" /
DRAIN PLUG 1"1/4

03029BP: FABAR SRL



3124108 PILETTA
COLONNA LAVAGGIO
CESTO FISSO /
DRAIN JUNCTION

984065000:
GRUPPO CIMBALI
SPA
9191116:
GRUPPO CIMBALI
SPA



3124090 PILETTA
SCARICO 43-48 /
DRAIN JUNCTION 43-
48

9020009:
GRUPPO CIMBALI
SPA
984203000:
GRUPPO CIMBALI
SPA



3124091 PILETTA
ASPIRAZIONE SAP* /
SUCTION DRAIN
JUNCTION SAP*

984229000:
GRUPPO CIMBALI
SPA
9020012:
GRUPPO CIMBALI
SPA



3124092 PILETTA
SCARICO 53-NP60 /
DRAIN JUNCTION 53-
NP60

9021210:
GRUPPO CIMBALI
SPA
977022000:
GRUPPO CIMBALI
SPA



3124025 PILETTA
ASPIRAZIONE CON
ASTINA 020010 /
SUCTION PILE WITH
ROD 020010

984002000:
GRUPPO CIMBALI
SPA
9020010:
GRUPPO CIMBALI
SPA



3124093 PILETTA
ASPIRAZIONE CON
ASTINA 53-60 /
DRAIN JUNCTION 53-
60

9021218:
GRUPPO CIMBALI
SPA
977013000:
GRUPPO CIMBALI
SPA



3124137 TRONCHET
TO ASPIRAZ.C85-140 /
INTAKE FITTING C85-
140

33451:
HOONVED - ALI SPA



3124095 PILETTA
SCARICO P 60-80-120 /
DRAIN JUNCTION P
60-80-120

0200113: LAMBER
SRL
*: FABAR SRL
9191111:
GRUPPO CIMBALI
SPA



GASKET=2102321,
GASKET=2102112,
NUT=3124096

3124129 PILETTA
PER FILTRO
ASPIRAZIONE /
SUCTION DRAIN
JUNCTION

LB95H: LASA SRL



4115100 RACCORDO
ASP. MOD. 1 /
SUCTION JUNCTION
MOD.1

GA111:
OMNIWASH SRL -
SOCIETA' A SOCIO
UNICO



3124242 PILETTA
ASPIRAZIONE MOD. 1-
2 PS GRIGI /
SUCTION DRAIN
JUNCTION MOD. 1-2
PS GREY

GAPS1299BGR:
OMNIWASH SRL -
SOCIETA' A SOCIO
UNICO



3124232 PILETTA
ASPIRAZIONE PS 4/82
GRIGIO RAL /
DRAIN INLET PS 4/82
GREY RAL

GA111TBGR:
OMNIWASH SRL -
SOCIETA' A SOCIO
UNICO



4115075 RACCORDO
ASPIRAZIONE MOD.
3/4 /
SUCTION
CONNECTION MOD.
3/4

18010134:
NUOVA SIMONELLI
SPA
GA311BGR:
OMNIWASH SRL -
SOCIETA' A SOCIO
UNICO



3124012 RACCORDO
SCARICO VASCA IME
1-2 /
TANK DRAIN
JUNCTION IME 1-2

GS117:
OMNIWASH SRL -
SOCIETA' A SOCIO
UNICO
GS117BGR:
OMNIWASH SRL -
SOCIETA' A SOCIO
UNICO



NUT=1141063,
GASKET=2101402

4115971 PILETTA
SCARICO 3-4 VASCA
BIANCA STAMPO 11
UNI /
DRAIN FITTING

GS317BGR:
OMNIWASH SRL -
SOCIETA' A SOCIO
UNICO

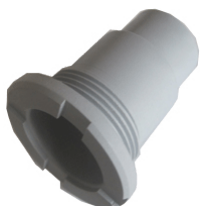

NUT= 1141004

3124026 RACCORDO
SCARICO LT /
DRAIN JUNCTION LT

38124006:
RANCILIO SPA



3124054 RACCORDO
SCARICO LS /
DRAIN JUNCTION LS

38124024:
RANCILIO SPA



3124021 RACCORDO
SCARICO LS
COMPLETO /
COMPLETE DRAIN
JUNCTION LS

15705111:
RANCILIO SPA



4115320 RACCORDO
ASPIRAZIONE POMPA
LT /
PUMP SUCTION JOINT
LT

38123468:
RANCILIO SPA



3124016 RACCORDO
SCAR. 1"1/4 6-7-8-9-13 /
"DRAIN JUNCTION
1"1/4 6-7-8-9-13"

906464: SILANOS
SRL
905450: SILANOS
SRL



diameter=35 mm

3124008 PILETTA
SCARICO R41
SILANOS /
DRAIN JUNCTION R41
SILANOS

905440: SILANOS
SRL



O-RING=2101569,
NUT=3124009

3124193 PILETTA
SCARICO 1"1/4 FORO
PICCOLO 31mm PER
3111030 PLASTICA /
DRAIN JUNCTION
1"1/4 HOLE D.31mm

905249: SILANOS
SRL



overflow=3111030,
Diameter = 31mm

4115091 MOZZO+GH
IERA GIRANTE
LAVAGGIO '96 /
WASH ARM CENTER +
FERRULE '96

904277: SILANOS
SRL



4115029 RACCORDO
ASPIRAZIONE 1"1/4 /
"SUCTION
CONNECTION 1"1/4"

905380:
SILANOS SRL



3101029 TAPPO
POMPA
SCARICO+FILTRO+GU
AR. /
FILTER

906431: SILANOS
SRL



4115166 RACCORDO
ASPIRAZ.1" /
"SUCTION PILE 1"1/4"

905390:
SILANOS SRL



3124053 GHIERA
RACCORDO
ASPIRAZIONE /
SUCTION JOINT RING

PASSPORT45.30/50.3
2/50.35/55.40/1040.P
ROJET28,6L4.32:
ARISTARCO KASTEL
SPA

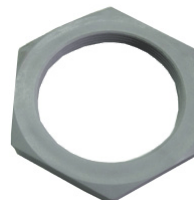

3124115 "GHIERA
1"1/2 PILETTA F-
C75=/" /
"NUT FOR OUTFLOW
FITTING 1 1/2"

180102:

COMENDA ALI SPA



3124117 GHIERA X
MUL.INOX BHC /
LOCKING RING BHC

180148:

COMENDA ALI SPA

35234:

HOONVED - ALI SPA



3124060 GHIERA
CON GANCIO S/ZA
CROCE / RING WITH
HOOK S/ZA CROCE

180147:

COMENDA ALI SPA

31637:

HOONVED - ALI SPA



o-ring=2101410,
=3124019

3124122 GHIERA
BREAK TANK
PLASTICA /
BREAK TANK NUT

180149:

COMENDA ALI SPA

180149:

HOONVED - ALI SPA



3124057 DADO
PILETTA G2 ESA 75 /
NUT FOR DRAIN
JUNCTION G2 ESA 75

DW10200114:

DIHR-ALI SPA



4115384 GHIERA
FIS.TORRETTA TIPO 28
GS P646 /
NUT 28 GS P646

DW500623:

DIHR-ALI SPA



3124217 GHIERA
GIRANTE PLASTICA 05
/
IMPELLER RING NUT
PLASTIC 05

DW500701:

DIHR-ALI SPA



3124241 GHIERA
COLLETTORE
CENTRALE DI
LAVAGGIO /
RING COLLECTOR
WASH CENTRAL

429053:

ELETTROBAR

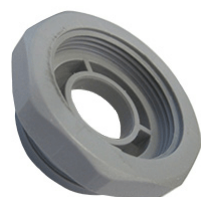

3124114 GHIERA
INFERIORE PER
LAVABICCHIERI /
RINSE NOZZLE CAP

429051:

ELETTROBAR

*:

MBM- EUROTEC SRL

- DIV. COOKING

SERVICE



3124126 GHIERA
COND.CENTRALE X5
/ SCREW
CONNECTION

*:

MBM- EUROTEC SRL

- DIV. COOKING

SERVICE

429069:

ELETTROBAR

DIVISIONE DELLA

EUROTEC SRL



3124128 GHIERA
LAVAGGIO
INFERIORE INTERNO
ALTA /
SCREW CONNECTION

*:

MBM- EUROTEC SRL

- DIV. COOKING

SERVICE

80281exELETTROBAR

80285:

MBM- EUROTEC SRL

- DIV. COOKING

SERVICE

80285:

ELETTROBAR

DIVISIONE DELLA

EUROTEC SRL



3124147 GHIERA
LAVAGGIO
INFERIORE INTERNO /
OPPOSITE SUPPORT

*:

MBM- EUROTEC SRL

- DIV. COOKING

SERVICE

80181:

ELETTROBAR

DIVISIONE DELLA

EUROTEC SRL



3124209 GHIERA
BUSSOLA LAVAGGIO
X5 /
RING NUT FOR WASH
BUSHING 3/4"

308031:

ELETTROBAR

DIVISIONE DELLA

EUROTEC SRL



3124101 GHIERA DI GUIDA / PLASTIC NUT
429008:
ELETTROBAR
DIVISIONE DELLA EUROTEC SRL



3124200 GHIERA CENTRAGGIO PETT.INF.CL.3 / CENTRAL NUT LOWER ARM
429052:
ELETTROBAR
DIVISIONE DELLA EUROTEC SRL



3124245 GHIERA / NUT
429074:
ELETTROBAR
DIVISIONE DELLA EUROTEC SRL



3124098 PILETTA SCARICO CILINDRICA C/PIOLI / NUT FOR DRAIN JUNCTION WITH HOOKS
C44, C66, C77:
ELFRAMO SPA



3124096 DADO PILETTA SCAR.P 60-80-120 / DRAIN JUNCTION NUT P 60-80-120
9191112:
GRUPPO CIMBALI SPA



3124018 GHIERA PILETTA SCARICO C 43/48 / DRAIN JUNCTION METAL RING C 43/48
33734:
HOONVED - ALI SPA



3124116 GHIERA MEDIA X ASTA LAVAGGIO / MEDIUM RING FOR WASH ROD
25007:
HOONVED - ALI SPA



3124136 PILETTA DI SCARICO SERIE 60 / WASH ARM HOLDER LOWER
34790:
HOONVED - ALI SPA



3124097 GHIERA PILETTA ASP. P. / RING DRAIN SUCTION P.
180145:
HOONVED - ALI SPA
25006ex:
HOONVED - ALI SPA
180145:
COMENDA ALI SPA



3124167 PILETTA DI SCARICO FIL. 1" 1/2" / DRAIN DRAIN FIL. 1" 1/2"
25138:
HOONVED - ALI SPA



3124192 GHIERA FISSAGGIO GRUPPO PLASTICA / NUT FIXING PLASTIC GROUP
104403: KRUPPS S.R.L.

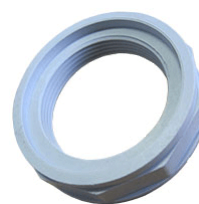

3124130 DADO PER PILETTA / NUT FOR OUTFLOW FITTING
LB95H: LASA SRL



3124105 GHIERA FISSAGGIO SUPPORTO GETTI / FIXING NUT FOR RINSING JET SUPPORT
2609740: LASA SRL



3124199 GHIERA FISSAGGIO MANDATA / NUT FOR LOT JUNCTION
45106500:
MODULAR SPA



3124231 GHIERA
GIRELLO PICCOLO
GRIGIO RAL 7 /
NUT WALKER LITTLE
GREY RAL 7
661THBGR:
OMNIWASH SRL



3124146 GHIERA
SUPERIORE 1-2-4/82
CQ C/FORI STAM IME
1TH /
UPPER RING 1-2-4/82
CQ W/HOLE STAM IME
1TH
LS03PGRC:
OMNIWASH SRL -
SOCIETA' A SOCIO
UNICO



4120041 MOZZO+GH
IERA LAVAGGIO LS /
"BUSH ?" WIDTH A/F
43 ID ? 16mm"
38123155:
RANCILIO SPA



3124009 DADO
PILETTA SCARICO 1"
SILANOS /
"NUT FOR DRAIN
JUNCTION 1"
SILANOS"
902070: SILANOS
SRL



O-RING=2101569,
PILETTA=3124008

4115227 GHIERA
GIRANTE LAVAGGIO
1300 LP67 LP109 /
WASH ARM GROOVE
NUT 1300 LP67 LP109
902890: SILANOS
SRL



4115107 GHIERA
MOPLER 1"1/4
ASPIRAZIONE /
"FERRULE 1"1/4"
902080: SILANOS
SRL



3124107 GHIERA DI
FISSAGGIO GRUPPO
LAVAGGIO /
NUT FOR WASH ARM
ASSEMBLY
20017:
SISTEMA PROJECT
SERVICE SRL

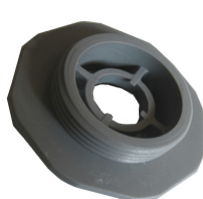

3124233 GHIERA DI
FISSAGGIO GRUPPO
CROCE /
NUT FIXING CROSS
GROUP
20017B:
SISTEMA PROJECT
SERVICE SRL

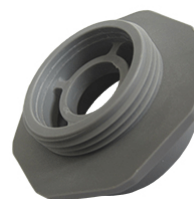

3124151 GHIERA
CENTRAGGIO /
LOCKING RING /
3338:
UNIVER-BAR SRL



3124244 Ghiera di
fissaggio /
NUT FIXING
4225:
UNIVER-BAR SRL



3124218 "GHIERA
1/2" /
NUT 1/2" ""
04047B: FABAR SRL



3124220 GHIERA
1/4" /
RING NUT 1/4 "
04049: FABAR SRL



3124077 GHIERA
INOX X BUSSOLA
MUL. 650 /
STAINLESS STEEL
RING FRO BUSH 650
33469EX:
HOONVED - ALI SPA
36011:
HOONVED - ALI SPA



3124173 "ROSETTA
OTTONE 1" /
"BRASS WASHER 1"
1132: KRUPPS S.R.L.



3124234 GHIERA
INOX Ø61 CON
ANELLO INOX Ø50 /
STAINLESS STEEL
RING NUT Ø 61 - WITH
STAINLESS STEEL
RING Ø50

104073T:

KRUPPS S.R.L.



3124190 GHIERA
FISSAGGIO GIRANTE /
FIXING NUT FOR
WASH ARM

12020: ADLER S.P.A.



3124131 GHIERA DI
RISCIACQUO AF AL /
UNION NUT SPECIAL
D. 32mm H 7mm

4355: A.T.A. SRL



3124066 GHIERA
MULINELLO
RISCIACQUO FC /
KNURLED NUT

280413:

COMENDA ALI SPA



3124197 GHIERA X
ALBERINO
RISCIACQUO FC2006 /
RING FOR SHAFT
RINSE FC2006

280419:

COMENDA ALI SPA

280419:

HOONVED - ALI SPA



3124024 GHIERA
FILTRO 085502 /
FILTER METAL RING
085502

984516000:

GRUPPO CIMBALI
SPA

9085502:

GRUPPO CIMBALI
SPA



3124118 GHIERA
FISSAGGIO MOZZO /
HUB FIXING NUT

230598: LASA SRL



4115648 NOTTOLIN
O FISS. GIRANTE CQ
BIANCO COMP /
SCREW FOR
WASHARM

LS09PBGR:

OMNIWASH SRL -
SOCIETA' A SOCIO
UNICO



3124013 GHIERA
FILTRO SILANOS /
FILTER METAL RING
SILANOS

902850: SILANOS

SRL



4115008 GHIERA
FERMO GIRANTI
SILANOS /
ROD LOCK METAL
RING SILANOS

902880: SILANOS

SRL



3124226 GHIERA /
NUT

069530:

ELECTROLUX
PROFESSIONAL
S.P.A.



3124182 GHIERA DI
FISSAGGIO /
NUT

45102214:

MODULAR SPA



3124204 CURVA
SCARICO /
DRAIN ELBOW

9121206:

GRUPPO CIMBALI
SPA



3124032 CURVA
CON GHIERA X
SCARICO /
CURVE WITH RING
FOR DRAIN JUNCTION

Z1AD011: SIMAG SPA

Z1AD011:

SCOTSMAN ICE SRL



3125001 CRICCHET
TO LT COMPLETO /
WHOLE PAWL LT
15706001:
RANCILIO SPA
10775: DIHR-ALI
SPA
AC046: OEM ALI
SPA
0800006: LAMBER
SRL



3125036 ASSIEME
SCROCCHETTO
INOX.P 48-60-80 /
STAINLESS STEEL
WHOLE PAWL 48-60-
80
984757000:
GRUPPO CIMBALI
SPA
9131640:
GRUPPO CIMBALI
SPA



3125088 SCROCCH
TTO COMPLETO
INOX /
COMPLETE WHOLE
PAW STEEL
984758000:
GRUPPO CIMBALI
SPA
9131635:
GRUPPO CIMBALI
SPA

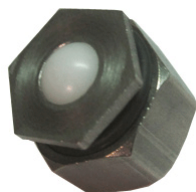

3125083 SCROCCH
TTO PORTA
RAGGIATO COMP /
RADIUS HOLDER
LATCH COMPLETE
AM011R:
OMNIWASH SRL -
SOCIETA' A SOCIO
UNICO



3125037 SFERA
DELIN
SCROCCHETTO* /
WHOLE PAWL
DERLING
984267000:
GRUPPO CIMBALI
SPA
9131486:
GRUPPO CIMBALI
SPA



3125017 SCROCCH
TTO A.PO 31W0061 /
WHOLE PAWL A.PO
31W0061
31W0061:
ANGELO PO GRANDI
CUCINE SPA



3125008 PIOLO
SERRATURA INOX
ELETTROBAR /
SPIGOT DOOR CATCH
325030:
ELETTROBAR
DIVISIONE DELLA
EUROTEC SRL



3125020 CRICCHET
TO PORT.RAINBOX
COMPLETO /
COMPLETE WHOLE
PAWL RAINBOX
15706002:
RANCILIO SPA



3125009 SCROCCH
TTO INOX CON
ROTELLA /
STAINLESS STEEL
WHOLE PAWL WITH
ROLLER
906121: SILANOS
SRL
*****:
RANCILIO SPA
31W0061:
SILANOS SRL



3125019 SCROCCH
TTO A ROTELLA /
ROLLER WHOLE
PAWL
fc543:
COMENDA ALI SPA
C48, APS43, APS48:
HOONVED - ALI SPA



3125027 SCROCCH
TTO F MONTATO /
WHOLE PAWL F
381403:
COMENDA ALI SPA



3125081 SCROCCH
TTO LF ANNO 2006 /
DOOR WHOLE PAWL
LF YEAR 2006
180508:
COMENDA ALI SPA



3125023 BLOCCHET
TO CRICCHETTO PER
PORTA '96 /
DOOR CATCH
DW150402D:
DIHR-ALI SPA



3125012 SCROCCHETTO PORTELLINO
PREM. STS+FERMO
BRAC. PORT. /
DOOR WHOLE PAWL
STS + DOOR ARM
STOP

20018+25052:

HOONVED - ALI
SPA



3125030 SCROCCHETTO PORTA T.N
HOONVED /
DOOR LOCKING
CATCH

20018:

HOONVED - ALI SPA



3125034 INNESTO
FERMO PORTA HNVD
/

DOOR CATCH HNVD

25052:

HOONVED - ALI SPA

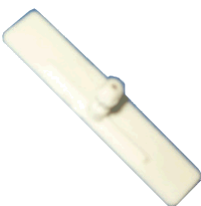

3125013 BLOCCHETTO
TO PORTA
T/N+INNESTO FERMO
PORTA /
DOOR WHOLE PAWL
T/N+DOOR STOP
CLUTCH

22121+18069:

HOONVED - ALI SPA

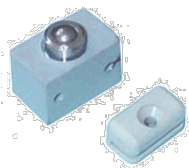

3125045 SCROCCO
PORTA AL 03-05 /
DOOR WHOLE PAWL
AL03-05

4713: A.T.A. SRL



3125033 SCROCCHETTO ZANUSSI /
CATCH ZANUSSI

049271:

ELECTROLUX
PROFESSIONAL
S.P.A.



3125054 SCROCCO /
DOOR LOCKING
CATCH

069435:

ELECTROLUX
PROFESSIONAL
S.P.A.



3125007 GRUPPO
SERRATURA 22/44
ELETTROBAR /
WHOLE PAWL 22/44
994011:

ELETTROBAR
DIVISIONE DELLA
EUROTEC SRL



3125064 SERRATURA
A PER SPORTELLINO
PER LAVASTOVIGLIE
/
DOOR CATCH DOOR
LOCKING CATCH

DWS30:

ELETTROBAR
DIVISIONE DELLA
EUROTEC SRL
994012:

ELETTROBAR
DIVISIONE DELLA
EUROTEC SRL

*:

MBM- EUROTEC SRL
- DIV. COOKING
SERVICE



3125065 SERRATURA
A F.FEC023
8440020013 /
DOOR LOCK

RTFOC00648:

ELETTROBAR
DIVISIONE DELLA
EUROTEC SRL
RTFOC00648:

MBM- EUROTEC SRL
- DIV. COOKING
SERVICE



3125091 LING.
SERRATURA
maggiorata 11 /
LATCH LOCK
ENHANCED
329012:

ELETTROBAR
DIVISIONE DELLA
EUROTEC SRL



spring=1117780

3125006 BLOCCHETTO
TO CHIUSURA
POSTERIORE /
POSTERIOR WHOLE
PAWL

00011028:

ELFRAMO SPA



3125048 BLOCCHETTO
TO INFERIORE MR /
DOOR LOCK

00001680:

ELFRAMO SPA



3125094 BLOCCHET
TO CHIUSURA D40
ASSIEME /
ASSEMBLY WHOLE
PAWL D40
00013867:
ELFRAMO SPA



3125005 BLOCCHET
TO CHIUSURA
ANTERIORE /
ANTERIOR WHOLE
PAWL
00011040:
ELFRAMO SPA



3125078 KIT
MONTAGGIO MOLLE
SOLLEV.SPORTELLO /
ROLLER SPRING
COMPLETE INC.
HOLDER 39mm
927267:
ELETTROBAR
DIVISIONE DELLA
EUROTEC SRL



3125022 CRICCHET
TO COMPLETO
PORTA '96 GS /
WHOLE PAWL '96' GS
3030100:
ANGELO PO GRANDI
CUCINE SPA
DW150402:
DIHR-ALI SPA



3125050 SICUREZZ
A PORTA BIANCA
COMP ASS. (C.
ANT+POST) /
ACTUATOR FOR
DOOR TOUCH
SENSITIVE SWITCH
COMPLETE
CEMP18EX:
OMNIWASH SRL -
SOCIETA' A SOCIO
UNICO
CEMP1823BGR:
OMNIWASH SRL -
SOCIETA' A SOCIO
UNICO



4115718 CONTENITO
RE SALE STRETTO /
SALT TANK
406998:
ELETTROBAR
DIVISIONE DELLA
EUROTEC SRL



2102148

4115717 CONTENITO
RE SALE BASSO /
SALT TANK
049075:
ELECTROLUX
PROFESSIONAL
S.P.A.



2102148

4115002 CONTENITO
RE SALE COMPLETO /
COMPLETE SALT
TANK
631302: COMENDA
977055000:
GRUPPO CIMBALI SPA
406999: ELETTROBAR
7642: A.T.A. SRL
15705115:
RANCILIO SPA
901770:
SILANOS SRL
CERI43:
OMNIWASH SRL -
SOCIETA' A SOCIO
UNICO
38123006: RANCILIO
901771: SILANOS
DWS21: COLGED
10370: ADLER S.P.A.
DW16065: DIHR
DW16067: DIHR
0200149: LAMBER
9021038:
GRUPPO CIMBALI SPA
25051: HOONVED
20151: HOONVED



2102148, 2101479

4120241 TAPPO
FORO BOCCIA SALE /
SALT TANK PLUG
906413:
SILANOS SRL
15705114:
RANCILIO SPA



4115445 TAPPO
FORO+ GHIERA X
CONT.SALE /
PLUG FOR MACHINES
WITHOUT SOFTNER
160755:
COMENDA ALI SPA



4120616 COPERCHIO
CONTENITORE
BRILLANTANTE /
COVER CONTAINER
AID
1073: A.T.A. SRL



4115915 SERBATOIO
AIR GAP /
TANK AIR GAP
191095:
COMENDA ALI SPA
191095:
HOONVED - ALI SPA



4120332 B.T.C/GHIER
A (TP 54000500) /
BREAK TANK
191108:
COMENDA ALI SPA



4115483 SUPPORTO
CONTENITORE
BRILLANTANTE F45
COMENDA /
SUPPORT HOUSING
RINSE AID F45
COMENDA
F45: COMENDA



4115462 CORNICE
PER CONTENITORE F45
/
CONTAINER FRAME
F45
191047:
COMENDA ALI SPA



4120536 AIRGAP
SPECIALE LA50 /
SPECIAL AIRGAP LA50
144021:
ELETTROBAR
DIVISIONE DELLA
EUROTEC SRL



4120653 SERBATOIO
SOFT-START LA50 /
TANK SOFT-START
LA50
999316:
ELETTROBAR
DIVISIONE DELLA
EUROTEC SRL
144028:
ELETTROBAR
DIVISIONE DELLA
EUROTEC SRL



4115726 CONTENITO
RE BRILL. SQ 120/
ASSI++++ /
RINSE CENTRAL
CONTAINER SQ 120
00011060:
ELFRAMO SPA

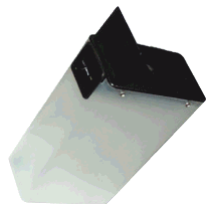

4120092 SERBATOIO
BRILLANTANTE /
RINSE AID TANK
9020035:
GRUPPO CIMBALI SPA



4120408 SERVICE-
KIT WATERBREAK /
SERVICE-KIT
WATERBREAK
01297695001:
HOBART GmbH



4120256 SISTEMA
CARICAMENTO CRP /
AIR TRAP
144032:
MBM- EUROTEC SRL -
DIV. COOKING
SERVICE
144027:
ELETTROBAR
DIVISIONE DELLA
EUROTEC SRL
65144032:
RANCILIO SPA

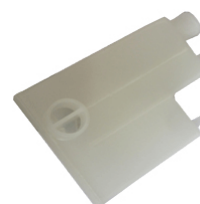

4115045 CONTENITO
RE BRILLANTANTE
IME /
DETERGENT
CONTAINER IME
AM027:
OMNIWASH SRL -
SOCIETA' A SOCIO
UNICO



4115028 CONTENITO
RE ADDITIVO SILANOS
/
ADDITIVE TANK
SILANOS
901761:
SILANOS SRL



4120194 TANICA
BRILLANTANTE /
RINSE AID TANK
1511:
UNIVER-BAR SRL



4120280 DISPOSITIV
O ANTIRISUCCHIO PER
GS 215 /
SERIE GS 300 /
BACKFLOW KIT FOR
GS215 AND GS300
60004391:
WINTERHALTER
ITALIA SRL



4120492 KIT
MEDIAMAT CYCLO /
KIT Mediamat CYCLO
60003513:
WINTERHALTER
ITALIA SRL



4120143 CICLOTRON
E/
CYCLOTRON
61005184:
WINTERHALTER
ITALIA SRL



4120684 01-245170-
010 PLASTIC
STRAINER /
01-245170-010 PLASTIC
STRAINER
0124517010:
HOBART GmbH



4120468 KIT
CONTENITORE PER
DETERSIVO /
CONTAINER KIT FOR
DETERGENT
60003746:
WINTERHALTER
ITALIA SRL

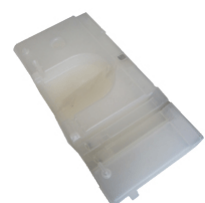

4115631 TEE X
BREAK TANK /
TEE X BREAK TANK
180420:
COMENDA ALI SPA



4120643 TEE AIR
GAP INOX /
TEE AIR GAP INOX
38395:
HOONVED - ALI SPA



4115269 TEE
PARASPRUZZI
VALVOLA ANT° /
TEE FOR VALVE
33502:
HOONVED - ALI SPA
190330:
COMENDA ALI SPA



4115796 GIUNZIONE
DI RISCIAQUO /
RINSE JUNCTION
143268: MBM
143268: ELETTOBAR
*: MBM
143173ex: ELETTOBAR



R

4115349 GUAINA
INOX PER SENSORE
PTC /
PLUNGER SOCKET 1-
FOLD
450521:
COMENDA ALI SPA



4115464 GUAINA
CORTA PER
TEMOSTATO FC/LF /
TANK THERMOSTAT
SHIELD FC-LF
450519:
COMENDA ALI SPA



4115463 GUAINA
TERMOST. INOX "1
TUBO" /
1 BULB STAINLESS
STEEL THERMOSTAT
SHEATH
450515:
COMENDA ALI SPA



4115454 GUAINA
TERMOSTATO INOX "2
TUBI" /
2 BULBS STAINLESS
STEEL THERMOSTAT
SHEATH
450516:
COMENDA ALI SPA



4115348 GUAINA
INOXTERMOSTATO A
3 BULBI COMENDA /
3 BULBS
INOX THERMOSTATE
SHEATH COMENDA
450520:
COMENDA ALI SPA



4115478 PORTAGOM
MA GOMITO INOX /
INJECTOR S/S FOR
DETERGENT INJ.
65468151:
RANCILIO SPA
EX180308:
COMENDA ALI SPA
468151:
ELETTOBAR
DIVISIONE DELLA
EUROTEC SRL
*:
MBM- EUROTEC SRL -
DIV. COOKING
SERVICE



piattello tenuta=24mm,
Foro=10mm

4120027 PORTAGOMMA IN ACCIAIO / INJECTOR S/S FOR DETERGENT INJ.

049801:
ELECTROLUX
PROFESSIONAL
S.P.A.



4115731 RACCORDO OTTONE PORTA GOMMA 3/8 M CURVO / FITTING BRASS DOOR RUBBER 3/8 M ELBOW

929163:
ELETTROBAR
DIVISIONE DELLA
EUROTEC SRL



4120661 RACCORDO INOX ENTRATA DETERSIVO VASCA ANT. / JUCTION INOX FRONT ENTRY DETERGENT TANK

906708:
SILANOS SRL



ØFiletto=5mm, Ø=4mm

4115646 PORTAGOMMA CURVO A 90° 1/4 F / HOSE CONNECTOR 90° 1/4 F

32352EX:
HOONVED - ALI SPA



4115215 RACCORDO ANTICONDENSA / HOSE ELBOW

2927:
ARISTARCO SPA



4115419 PORTAGOMMA DOSATORE COMENDA / NIPPLE F.RINSE AID INJECTOR

180306:
COMENDA ALI SPA



4115381 TORRETTA SUP.MOZZO RISC. 35/40 / RINSE ARM HOLDER

DW350402:
DIHR-ALI SPA



4115231 PIPA RACCORDO PLASTICA 35/40/22 / PLASTIC FITTING PIPE

E41, E42, E52:
ELETTROBAR
DIVISIONE DELLA
EUROTEC SRL
E45, E35H, 40F, 40FD, 400F, 400FD, 40F
ELECTRONIC, E40, E40H:
ELETTROBAR
DIVISIONE DELLA
EUROTEC SRL



4120265 Z203012000 EMPALME PRESOSTATO / Z203012000 PRESSURE SWITCH CONNECTION

12024157:
FAGOR
INDUSTRIALE S.R.L.



4115004 RACCORDO GIR. TRAPPOLA ARIA IME / AIR TRAP BASKET HOLDER SUPPORT CONNECTION IME

GPO26ABGR:
OMNIWASH SRL



4115156 PIPETTA POMPA AUMENTO PRESSIONE C/TS / JOINT FOR PRESSURE INCREASE PUMP C/TS

901652:
SILANOS SRL



4120413 RACCORDO AD ANGOLO INF C/INS. M13x1 COL. NERO / 90° JUNCTION LOWER M13X1

10620:
ARISTARCO KASTEL
SPA



PORTAGOMMA Ø12mm

4115543 RACCORDO GOM.RISC.C70-C155-75 / RINSE JOINT C70-C155-75

190315:
COMENDA ALI SPA
190315:
HOONVED - ALI SPA



4115146 RACCORDO PORTAGOMMA HOONVED / JOINT HOONVED

25036:
HOONVED - ALI SPA



4120228 CODULO
CURVO A DOPPIA
PRESA /
SHANK

160202:

COMENDA ALI SPA

160202:

HOONVED - ALI SPA



4115923 RACCORDO
90°FILET.POMPA
32X1,5 /
CONNECTION 90°
32X1,5

32721:

HOONVED - ALI SPA



4120159 RACCORDO
RISCIACQUO C33/C34 /
RINSE JUNCTION
C33/C34

H190311:

HOONVED - ALI SPA

190311:

COMENDA ALI SPA



4115178 GOMITO
ASTA RISCIACQUO
SUPER. IME /
UPPER RINSE
JUNCTION IME

GR6193GR:

OMNIWASH SRL -
SOCIETA' A SOCIO
UNICO



4115450 RACCORDO
FISS. ASTA ESTERNO
CSSTAMPO 96 UNI /
ELBOW CONNECTION

GRS06BGR:

OMNIWASH SRL -
SOCIETA' A SOCIO
UNICO



4115639 RACCORDO
RISCIACQUO
POSTERIORE LP67/109 /
FLUSH FITTING REAR
LP67/109

907933:

SILANOS SRL



4115637 PORTAGOM
MA DIRITTO MOZZO
LAVAPIATTI /
HOSE CONNECTOR

906003:

SILANOS SRL



4115177 RACCORDO
GOMITO 1/4" 1000/1300
/
HOSE CONNECTOR
ANGLED 1/4" 1000/1300

908120:

SILANOS SRL



4120359 "DIRAMAZI
ONE R 3/4"" /
ELBOW 3/4""

3501005:

WINTERHALTER

ITALIA SRL



4115647 PORTAGOM
MA 1/2" MASCCHIO INOX
/
RUBBER HOLDER 1/2"
MALE INOX

251200:

COMENDA ALI SPA

32403*:

HOONVED - ALI SPA

251200:

HOONVED - ALI SPA



4115292 RACCORDO
OT X
ATTAC.PRESSOSTATO
/
HOSE CONNECTOR

280509:

COMENDA ALI SPA



4115844 "RACCORDI
12X1/2"" TP.P2F" /
"HOSE CLAMPS
STRAIGHT 12X1/2""

290216:

COMENDA ALI SPA



4115891 RACC.PORT
AGOM.X BOILER N
SE/1 /
NIPPLE FOR BOILER N
S

510407:

COMENDA ALI SPA



4115487 GOMITO FF
3/8X 1/4 C166 /
"ELL FF 3/8"" - 1/4"
C166"

280118:

COMENDA ALI SPA

280118:

HOONVED - ALI SPA



4115232 PORTAGOM
MA RISCIAQUO
"TURBO" /
"JOINT ""TURBO""
17564:

HOONVED - ALI SPA



4115270 PORTAGOM
MA 1/2 MASCHIO OT /
SCREW-IN SOCKET 1/2
290410:

COMENDA ALI SPA



4120639 "TUBO
RACCORDO LAV. LP70
lunghezza 258 mm - filetto
dato 1"1/2 /
PIPE FITTING
WASHING LP70 length
258 mm - threaded nut 1
"1/2

00065282:

ELFRAMO SPA



L=257mm

4115650 SUPPORTO
INF. RISC. CQ 1-2 OT
NICHEL /
RINSE JOINT CQ 1-2
NICHEL

LI33D:

OMNIWASH SRL -
SOCIETA' A SOCIO
UNICO



4115011 PORTAGOM
MA SUPPORTO
RISCIAQUO /
RINSE JOINT

GR016PNT:

OMNIWASH SRL -
SOCIETA' A SOCIO
UNICO



4115249 RACCORDO
RISCIAQUO LT105 /
CONNECTING FITTING
FOR WASH ARM
SUPPORT LT105

20122105:

RANCILIO SPA



4115367 PROLUNGA
X ASSE RISC. 11S /
EXTENSION SHAFT X
RISC. 11S

DW75315:

DIHR-ALI SPA



4115198 SUPPORTO
GIRELLO 43-48 /
BEARING FOR
ROTATION PLATE 43-
48

9031046:

GRUPPO CIMBALI SPA



4115573 RACCORDO
TUBO ESAGONALE /
RINSE PIPE FITTING

DW12006:

DIHR-ALI SPA

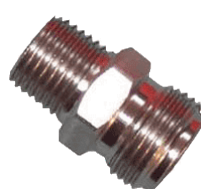

4120079 PREMISTOP
PA /
STUFFING BOX

OL0280:

ELECTROLUX
PROFESSIONAL
S.P.A.

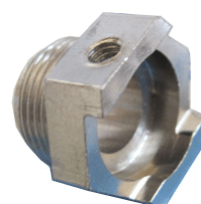

4115685 RACCORDO
RISC.COLONNA Q12-
DICESTO FISSO* /
RINSE ARM JOINT

984067000:

GRUPPO CIMBALI SPA

9191118:

GRUPPO CIMBALI SPA



4115658 PERNO
RISCIAQUO NAP /
RINSE PIN NAP

986004000:

GRUPPO CIMBALI SPA

9131287:

GRUPPO CIMBALI SPA



3118002 SUPPORTO
RISCIAQUO MOD.

4/82 /

RINSE JUNCTION
MOD. 4/82

LI533FOT:

OMNIWASH SRL -
SOCIETA' A SOCIO
UNICO



4120600 SUPPORTO
RISCIAQUO OT 4SA
NICHELATO /
SUPPORT RINSE 4SA
NICKEL

LISA33F:

OMNIWASH SRL -
SOCIETA' A SOCIO
UNICO



4115003 SUPPORTO
GIRELLO DOPPIO IME /
DOUBLE BASKET
HOLDER SUPPORT IME
661T2:

OMNIWASH SRL -
SOCIETA' A SOCIO
UNICO



4115030 SUPPORTO
GIRELLO SILANOS /
SUPPORT BASKET
HOLDER SILANOS
905349:

SILANOS SRL



4115636 SUPPORTO
GIRELLO R23-R29 /
SUPPORT BASKET
HOLDER R23-R29
906350:

SILANOS SRL



4115086 TAPPO DA
1/2 NTP CAP 106734 /
"SHOT PLUG FOR
PROTECTIVE
COVERING ?""
160727:

COMENDA ALI SPA



4115477 TAPPO TE
1/2" OT ESAGONO 27 /
"BRASS-TE-PLUG 1/2""
290105:

COMENDA ALI SPA



4115901 TAPPO
COLLETTORE
ELETTROV. 1 /
SHOT PLUG
160709:

COMENDA ALI SPA



4120030 TAPPO
CHAMP X COLL. NEW /
SUPPORT JET
160781:

COMENDA ALI SPA

H160781:

HOONVED - ALI SPA



4120571 PLUG /
PLUG
012450841:

HOBART GmbH



4120237 MEMBRANA
ARISTARCO /
RING NUT ARISTARCO
10467:

ARISTARCO SPA



1141321 GHIERA
FISSAGGIO
MULINELLO
/ RING NUT FIXING
REEL
261009:

COMENDA ALI SPA

H261009:

HOONVED - ALI SPA



1141135 VITE
FISSAGGIO GRUPPI
RISCIACQUO DIHR /
KNURLED SCREW
DW11101A:

DIHR-ALI SPA



1141136 DADO PER
MOZZO GIRANTE 11S
DIHR /
NUT IMPELLER
BEARINGS FOR 11S
DIHR
DW75317:

DIHR-ALI SPA



1141137 VITE
FISSAGGIO GRUPPI
M8X35 DIHR /
SCREW M8x35 GROUPS
DIHR
DW11101/B:

DIHR-ALI SPA



4120327 TAPPO INOX
ZIGRINATO /
THUMB SCREW
104040: KRUPPS S.R.L.



1141330 VITE
ZIGRINATA M8 /
SCREW M8
2535:

UNIVER-BAR SRL



4115057 TAPPO PG7
SILANOS /
CAP PG7 SILANOS
902678:
SILANOS SRL



4115910 SUPPORTO
LANC/LAVAGGIO
GRIGIO /
SUPPORT FOR
WASHING ARM RIN
80310:
ELETTROBAR
DIVISIONE DELLA
EUROTEC SRL
*:
MBM- EUROTEC SRL -
DIV. COOKING
SERVICE



4115640 SUPPORTO
MOZZO/LANCIA DI
LAVAGGIO GRIGIO
MM39 /
BEARING BUSH
926129:
ELETTROBAR
DIVISIONE DELLA
EUROTEC SRL



4115088 MOZZO
GIRANTE LAVAGGIO
1300 /
WASH ARM BEARING
1300
902891:
SILANOS SRL



4115278 PERNO
TIRANTE PORTINA BR
BC /
PIVOT DOOR GUY BR
BC
341922:
COMENDA ALI SPA



4115282 PERNO PER
TIRANTE PORTINA
BHC /
THREADED PART BHC
342701:
COMENDA ALI SPA



4115832 RIDUZIONE
BRACCIO LAVAGGIO /
WASH ARM BEARING
2001: MACH



4120254 PIASTR.RITE
GNO GHIERE DS 600 /
SLIDING PLATE DS 600
12019: ADLER S.P.A.



4115191 PIASTRINA
DI SCORRQ12-
EIIIMENTO TIRANTE
PORTA /
SLIDING PLATEPLACA
DE FRICCIÓN
35Z5530:
ANGELO PO GRANDI
CUCINE SPA
904952:
SILANOS SRL



4115174 GUIDA
TIRANTE GL/5.34-7.38 /
DOOR TENSION BAR
GUIDE GL/5.34-7.38
2919:
ARISTARCO SPA



4115461 PIAST.SCOR.
TIRAN.PORTA 110224 /
SLIDING PLATE F. TIE
ROD
160905:
COMENDA ALI SPA
331461:
COMENDA ALI SPA
H331461:
HOONVED - ALI SPA
160905:
HOONVED - ALI SPA



4115527 FERMO
TIRANTE PORTA B-F-
R- /
DOOR CATCH B-F-R
190619:
COMENDA ALI SPA
190619:
HOONVED - ALI SPA



4115276 BLOCCHETT
O PER TIRANTE BC-BR
/
SUPPORT FOR GASKET
160909:
COMENDA ALI SPA
160909:
HOONVED - ALI SPA



4115283 BLOCCHETT
O PERNO MANIGLIA C
/
REINFORCEMENT FOR
HANDLE SUPP.C165
190149:
COMENDA ALI SPA



4115466 PIASTR.FISS
.GUARNIZ.PORTA B-F /
FIXING PLATE FOR B-F
DOOR GASKET

331764:

COMENDA ALI SPA

331764: HOONVED



4115471 FERMO PER
SUPPORTO GUIDA AC /
CLAMPING PIECES AC

190146:

COMENDA ALI SPA



4115505 FERMO
GUIDE SE/1 /
GUIDE STOP SE/1

190620:

COMENDA ALI SPA



4115404 GUIDA
ASTA CURVA /
SLIDING PLATE

DW150401:

DIHR-ALI SPA



4120565 PIASTRINA
BRETELLA VERS.05 /
PLATE FOR DRIVING
VERS.05

DW250042:

DIHR-ALI SPA



4115224 BATTUTA
ASTA PORTA 40 /
DOOR ROD SUPPORT
40

307005:

ELETTROBAR



4115111 BATTUTA
DADO ASTA /
STOP PLATE

307003:

ELETTROBAR



4120472 AGGANCIO
PORTELLA BE /
HOOKING DOOR BE

00222419:

ELFRAMO SPA



lock = 4120649,
sping= 1117794

4115937 MOSTRINA
TIRANTE + DADO
FRESATO RIC /
LINKAGE GUIDE FOR
TIE BAR COMPLETE

13909: ELFRAMO SPA



4120308 SQUADRET
TA FIS.MOLLA C6-60-
68E /
SECURING BRACKET
SPRING C6-60-68E

36626:

HOONVED - ALI SPA



4115526 GOMMINO
BRACCETTO
PORTELLO /
DOOR GASKET

30007:

HOONVED - ALI SPA



4120509 GOMMINO
PARACOLPI PORTELLO
C53E-C68E /
RUBBER BUMPER
DOOR C53E-C68E

36633:

HOONVED - ALI SPA



4115001 SQUADRET
TA GUIDE PORTELLO
LT /
DOOR GUIDE SQUARE
LT

38123244:

RANCILIO SPA

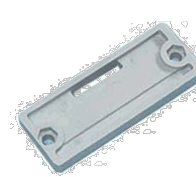

4115525 TAPPO D. 16
/
CAP D.16

32916:

HOONVED - ALI SPA



4115136 FERMO
BRACCETTO
PORTELLO /
DOOR LOCK

18069:

HOONVED - ALI SPA



4120632 ROTELLA
PER ECCENTRICO
TRAINO /
ECCENTRIC WHEEL
FOR TOWING

5724: KRUPPS S.R.L.

5724:

ARISTARCO KASTEL



4115233 CARRUCOL
A PESO AT /
PULLEY WEIGHT AT
9667: A.T.A. SRL



4120455 RUOTINA
AT /
WHEEL AT
9612: A.T.A. SRL



4115472 RUOTA
SCORR.GUIDA
CENTR.ANGOLO /
WHEEL F.CENTRAL
SLIDING
440108:
COMENDA ALI SPA



4115787 RUOTA DI
RINVIO /
ROPE PULLEY
00013784:
ELFRAMO SPA



4115836 BASE
RUOTA CAPP /
BASE COWL WHEEL
80130:
ELETTROBAR
*:
MBM- EUROTEC SRL -
DIV. COOKING
SERVICE



4115893 RUOTA
SCORRIMENTO
MANIGLIONE CAPP /
HANDLE SLIDING
WHEEL
80132:
ELETTROBAR



4115960 RUOTA
MANIGLIONE C /
BUSH C
00018050:
ELFRAMO SPA



4120602 RONDELLA
IN PTFE 40x19x6 mm /
WASHER-THRUST
PTFE 40x19x6 mm
119227:
HOBART GmbH



4120388 ROLLER /
ROLLER
299109:
HOBART GmbH



4120475 ROLLER /
ROLLER
299090:
HOBART GmbH



4120406 SERVICE
KIT /
SERVICE KIT
7348031:
HOBART GmbH



4120369 Ruota
scorrimento maniglione
sollevamento capotta
Compact /
Wheel sliding handle
lifting Capote-Compact
4711:
UNIVER-BAR SRL



4120576 RULLO X
SCORRIMENTO FUNE
LFD /
ROLLER FOR SLIDING
ROPE LFD
440517:
COMENDA ALI SPA
440517:
HOONVED - ALI SPA



4115906 "PIGNONE
Z17-1/2""-
D.20/CHIAV.AC" /
PINION Z17-1/2""-D.20
410240:
COMENDA ALI SPA



4120262 CORONE Z
35 PASSO 1/2 /
GEAR Z35 PACE 1/2
410308:
COMENDA ALI SPA



4120342 CORONA
Z22 AC150-AC90 /
GEAR AC150-AC90 Z22
H410312:
HOONVED - ALI SPA
410312:
COMENDA ALI SPA



4115873 PIGNONE
INOX 1/2 Z18 /
STAINLESS STEEL
PINION 1/2 Z18
TR0266:
SILANOS SRL



4120665 "GIUNTO
CATENA 1/2"" SE/1" /
CHAIN JOINT 1/2" SE/1
410903:
HOONVED - ALI SPA
410903:
COMENDA ALI SPA



4115828 CATENA
TRAINO 1/2"" N-AC-
ACR" /
"CHAIN 1/2"" N-AC-A-
ACR"
410801:
COMENDA ALI SPA



4115872 CATENA
T2000/TS2400 /
CHAIN T2000/TS2400
TR0027:
SILANOS SRL



4115039 GRUPPO
CONT.BRILL.ATT.FRO
NTALE /
RINSE CENTRAL
CONTAINER
CONNECTION FRONT
999016:
ELETTROBAR
069647:
ELECTROLUX
PROFESSIONAL
S.P.A.



4115009 SCATOLA
PORTAMICRO LTN /
MICROSWITCH-
HOLDER BOX LTN
15705010:
RANCILIO SPA



4115859 GUIDA
TELESC.DX-CA /
BASE UNIT 600mm
PAIR CNS
36M5390:
ANGELO PO GRANDI
CUCINE SPA



4115613 TIRANTE
DX-SX PASSPORT+AP /
ROD DX-SX PASSPORT
+ AP
4744:
ARISTARCO SPA



4120459 SCORRIMEN
TO SX CAPOTTA AT /
SLIDING LEFT HOOD
AT
9670: A.T.A. SRL



4120460 SCORRIMEN
TO DX CAPOTTA AT /
SLIDING RIGHT HOOD
AT
9669: A.T.A. SRL



4120647 GUIDA
CAPOTTA B 50-AT 900-
1000 617mm /
DRIVING HOOD B-50
AT 900-1000 617mm
9309: A.T.A. SRL

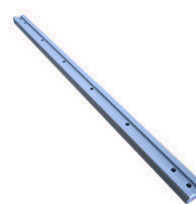

P=32mm, H=17mm,
L=616mm

4115978 TRAVERSA
SOSTEGNO PATTINI /
SUPPORT FOR
BASKET SLIDING PAD
342117:
COMENDA ALI SPA



4120471 GUIDA
CESTELLO DX C 68 E /
BASKET GUIDE DX C
68 E
H36585:
COMENDA ALI SPA
36585:
HOONVED - ALI SPA



4115481 GUIDA
PORTINA C30-70-75 DX
/ RIGHT DOOR GUIDES
C30-70-75

180605:
COMENDA ALI SPA



4115482 GUIDA
PORTINA C30-70-75 SX
/ LEFT GUIDE F. DOOR
C30-70

180606: COMENDA
ALI SPA



4115440 BINARIO
CAPOT C95/C155/165 /
DOOR GUIDE C95-155-
C165

180624:
COMENDA ALI SPA



4120140 PATTINO
SCORRIMENTO
CAPOTTA L=600 /
CAPOT GUIDE L=600

DW75304:
DIHR-ALI SPA



4120168 GUIDA
CAPOT /
CAPOT GUIDE

80069:
ELETTROBAR
80068ex:
ELETTROBAR
DIVISIONE DELLA
EUROTEC SRL



4120127 GUIDA
PORTELLA LP60
POLIZENE /
DOOR GUIDE LP60

00065245:
ELFRAMO SPA



4115998 GUIDA
CESTELLO DX APS 48
BRILL /
BASKET GUIDE APS 48

18940:
HOONVED - ALI SPA



4115545 GUIDA DI
SCORRIMENTO
ECOM.SE/1 /
SLIDING GUIDE

191051:
HOONVED - ALI SPA
191051:
COMENDA ALI SPA



4120625 GUIDA
PORTELLO DX C 68 E /
GUIDE DOOR DX C 68 E

36583:
HOONVED - ALI SPA



GUIDE DX = 4120510

4120510 GUIDA
PORTELLO SX C 68 E /
GUIDE DOOR SX C 68
E

36584:
HOONVED - ALI SPA



GUIDE DX= 4120625

4115147 KIT
SUPPORTO GUIDA
CESTO SX HOONVED /
LEFT BASKET GUIDE
SUPPORT KIT
HOONVED

21912:
HOONVED - ALI SPA



4115148 KIT
SUPPORTO GUIDA
CESTO DX HOONVED /
RIGHT BASKET GUIDE
SUPPORT KIT
HOONVED

21913:
HOONVED - ALI SPA



4120044 GUIDA DI
SCORRIMENTO IN PVC
PER CAPPOTTA /
PVC MANUAL COVER
SLIDING GIUDE

1201045:
KRUPPS S.R.L.



4120626 GUIDA
SCORRIMENTO IN
PEHD NERO /
GUIDE SLIDE HDPE
BLACK

1201046:
KRUPPS S.R.L.



L=604mm

4115627 FULCRO
INOX CROCIERA /
PIN FOR WASH ARM
MOUNTING POS.
UPPER/LOWER

2153:
ARISTARCO SPA



4115277 TIRANTE
PORTELLO LAVAB.BR-
BC /
GUY FOR DOOR
WASHER BR-BC
330227:
COMENDA ALI SPA



4115298 TIRANTE
M5X240 PER PORTA FC
/
TIE ROD
330233:
COMENDA ALI SPA



4115480 TIRANTE
5X305 LF350-F90 /
DOOR PIN 5X305 LF350-
F90
330209:
COMENDA ALI SPA



4115391 PROLUNGA
ASSE INOX 11S L140 /
RINSE PIPE
DW15304:
DIHR-ALI SPA



4120323 LEVA
PORTA /
DOOR LEVERAGE
049802:
ELECTROLUX
PROFESSIONAL
S.P.A.



4120585 ASTA
SOSTEGNO TENDINA
AUTORACK /
ROD SUPPORT
CURTAIN AUTORACK
77121:
ELETTRORBAR
DIVISIONE DELLA
EUROTEC SRL



L=585mm, Ø 8mm

4120154 TIRANTE
PORTELLA B14
ASSIEME /
DOOR ROD FOR B14
00210983:
ELFRAMO SPA



4115655 COPPIA
BRACCI PORTA
NP60/80 /
DOOR RODS NP60
9131253:
GRUPPO CIMBALI SPA



4120382 LIFT ROD /
LIFT ROD
015105572:
HOBART GmbH



4115590 TIRANTE
PER PORTELLO 43-53 /
TENSION BAR 43-53
34142:
HOONVED - ALI SPA



4115722 TIRANTE
PORTA GF90 /
DOOR TENSION BAR
GF90
34440:
HOONVED - ALI SPA
H34440:
COMENDA ALI SPA



4120269 SPINA
CONTENITORE
BRILLANTE DM. 2X80
INOX /
PLUG FOR RINSE AID
CONTAINER Ø=2x80
mm INOX
AM029:
OMNIWASH SRL -
SOCIETA' A SOCIO
UNICO



4120310 ASTA
PORTA
MIDI50/LOGOS/OMEGA
/
DOOR ROD
MIDI50/LOGOS/OMEGA
3327:
UNIVER-BAR SRL



4120437 Asta porta
Ergon/Midi40 /
Auction door
Ergon/Midi40
1524:
UNIVER-BAR SRL



4120674 Asta porta
Mix/Top /
ROD DOOR MIX/TOP
3265:
UNIVER-BAR SRL



L=425mm

4120519 ASTINA
FILTRO /
ROD FILTER
070343:
ELECTROLUX
PROFESSIONAL
S.P.A.
11409: ADLER S.P.A.



4120481 TIRANTE
PER MOD.T34/39I/S
C/CESTO IN PL. /
ROD FOR MOD.T34 / 39I
/ S C / PL IN BASKET.
04048P: FABAR SRL



4115536 ALBERINO
MULINELLO C95-155-
165 /
WASH ARM PIN C95-
155-165
33460:
HOONVED - ALI SPA



4115858 RACCORDO
/
CONNECTION
2306640: LASA SRL



4115056 TIRANTE
ESAGONALE GIRELLO
1-2 /
EXAGONAL SIUPPORT
FOR BASKET HOLDER
SUPPORT 1-2
GG1T5:
OMNIWASH SRL



4115700 ASTINA
FISSAGGIO FILTRO
QUATTRO Q/82 /
ROD MOUNTING
FILTER QUATTRO Q/82
GA5120TEX:
OMNIWASH SRL



4115669 TIRANTE
MOLLA 61-2P/S M10 /
ROD SPRING 61-2P / S
M10
GMML6271I:
OMNIWASH SRL -
SOCIETA' A SOCIO



UNICO

4120109 TIRANTE
ZINCATO COMPACT /
ROD COMPACT
4714:
UNIVER-BAR SRL



L= 438 mm

4115684 PIPETTA
SILENT /
WASHING ARM PIPE
SILENT
9131701:
GRUPPO CIMBALI SPA



4115673 PIPETTA
COLONNA P 43-48-60-
80-100 /
WASHING ARM PIPE
P43-48-60-80-100
P 43-48-60-80-100:
GRUPPO CIMBALI SPA
984068000:
GRUPPO CIMBALI SPA



4120069 UMIDIFICAT
ORE /
HUMIDIFIER
RTFOC00706:
MBM- EUROTEC SRL -
DIV. COOKING
SERVICE



4115537 RACCORDO
ALIMENTAZIONE
RISC. M /
JUNCTION
33476:
HOONVED - ALI SPA



4115208 RACCORDO
TUBO RISC.CON
OGIVA 1000-1300 /
HOSE CONNECTOR
1000-1300
908121:
SILANOS SRL



4115352 COPRIRESES
TENZA H 42 BASSO /
HEATING ELEMENT
COVER H42 SNL
161123:
COMENDA ALI SPA



4115053 PROTEZION
E RESISTENZA BOILER

/
BOILER HEATING
ELEMENT
PROTECTION

GB083FV0GR:

OMNIWASH SRL -
SOCIETA' A SOCIO
UNICO



4115499 ANTIVIBRA
NTE 25X20 M6 L18

60SH /
SHOCK ABSORBER
25X20 M6 L18 60SH

441139:

COMENDA ALI SPA



4115528 AMMORTIZ
ZATORE PORTA ED

630/90 /
DOOR SHOCK-
ABSORBER ED 630/90

31343:

HOONVED - ALI SPA



4115457 CILINDRO
COPRITIRANTE H101

PLASTICA /
PLASTIC COVER H101

4673:

ARISTARCO SPA



4115458 CILINDRO
COPRITIRANTE H95

PLASTICA /
COVER H95

4672:

ARISTARCO SPA



4120444 ASS.
COPRITIRANTE

PROJECT/28EM /
ASSY COVER ROD
PROJECT/28EM

2870:

ARISTARCO SPA



4120538 ASSIEME
COPRITIRANTE

SUPERIORE GL
1040/1240 /
COVER ASSEMBLY
ROD UPPER GL
1040/1240

2710:

ARISTARCO SPA



4120654 ASSIEME
COPRITIRANTE AP

55.40 /
TIE ROD COVERING
CYLINDER

9937:

ARISTARCO SPA



Ø=60mm, L=130mm

4120679 TAPPO
SCARICO ECORINSE

AC2001 /
PLUG DRAIN
ECORINSE AC2001

190345:

COMENDA ALI SPA

H190345:

HOONVED - ALI SPA



Ø=32X100mm

4115409 MOZZO
MULINELLO LAV. FC /

WASH ARM CENTER
(FC - MACHINES)

191069:

COMENDA ALI SPA

191069:

HOONVED - ALI SPA



4120135 TRONCHET
TO ASP. CON DEF.AC91

/
SUCTION SOCKET FOR
AC91

180236: .

COMENDA ALI SPA

180236:

HOONVED - ALI SPA



4120656 KIT MOZZO
PER MULINELLO

420572 /
WASHARM BUSH KIT

330824R:

COMENDA ALI SPA



4115363 ASSIEME
BICCHIERE CON

MANIC. G300 /
COVER

DW16250:

DIHR-ALI SPA



4115366 ASSIEME
MANICOTTO CO

BICCH. /
COVER

DW135250:

DIHR-ALI SPA



4120690 MANICOTTO INFERIORE 11/04
L=172mm GRIGIO /
BOTTOM SLEVE 11/04
L=172mm GREY

DW76077:

DIHR-ALI SPA



4120338 PROLUNGA DOSATORE IDRAULICO /
EXTENSION FOR DOSING PUMP

466005:

ELETTROBAR
DIVISIONE DELLA
EUROTEC SRL



4115800 RACCORDO ASPIRAZ.POMPA
353403 /
PUMP SUCTION JOINT
353403

468153:

ELETTROBAR
DIVISIONE DELLA
EUROTEC SRL

*:

MBM- EUROTEC SRL -
DIV. COOKING
SERVICE



4120655 TRABOCCO REGOLAZIONE PRELAVAGGIO .ACS-EDT /
OVERFLOW CONTROL PREWASHING .ACS-EDT

H160114:

HOONVED - ALI SPA

160114:

COMENDA ALI SPA

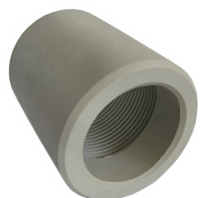

Ø=60mm, H=70mm

4115866 TRONCHETTO MAND. N45/N50/N90/N700FH /
LOT SOCKET N45/N50/N90/N700FH

903756:

SILANOS SRL



4120128 PORTAGOMMA TUBO DI SCARICO COSMO/COMPACT /
RUBBERHOLDER FOR DRAIN PIPE COSMO/COMPACT

4554:

UNIVER-BAR SRL



4115443 TENDINA ECORINSE SE/1-620X270 /
CURTAIN ECORINSE SE / 1-620X270

190913:

COMENDA ALI SPA



4115444 TENDINA ENTRATA / USCITA N 690X420 /
INLET/OUTLET CURTAIN 690x420 mm

190909:

COMENDA ALI SPA

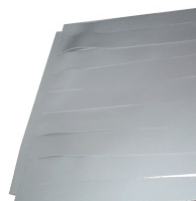

4115519 TENDINA ENT-USC 620X480 /
INTERMEDIATE CURTAIN 620X480X

190906:

COMENDA ALI SPA

190906:

HOONVED - ALI SPA

190910:

COMENDA ALI SPA

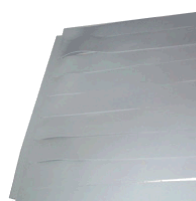

4120513 TENDINE ENTRATA/USCITA TRAINO 545x405 mm /
INLET/OUTLET CURTAIN 545x405 mm

75120:

ELETTROBAR
DIVISIONE DELLA
EUROTEC SRL

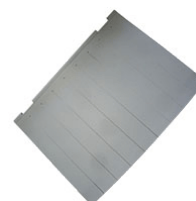

DIMENSIONS
545X405mm

4120584 TENDINE ENTRATA/USCITA TRAINO /
CURTAINS ENTRY - EXIT

77120:

ELETTROBAR
DIVISIONE DELLA
EUROTEC SRL

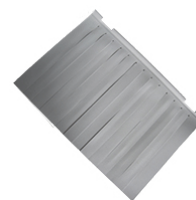

NUMBER OF
TEETH=14,
ROD=4120585,
DIMENSIONS
584X405mm

4120651 TENDINA INTERMEDIA TRAINO /
WIPE INTERMEDIATE TOWING

75123:

ELETTROBAR
DIVISIONE DELLA
EUROTEC SRL



DIMENSIONS
620X250mm

4120022 PORTINA FC54/543/544/HR /
DOOR FC54/543/544/HR

322941:

COMENDA ALI SPA



4120646 PROTEZION
E POSTERIORE B25-11-
12-18 /
REAR PROTECTION B
25-11-12-18

161104:

COMENDA ALI SPA

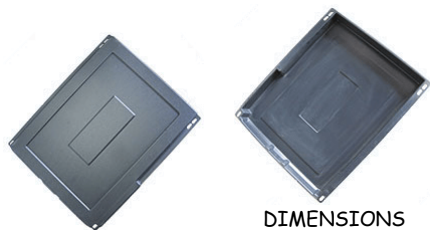

DIMENSIONS
440X530mm

4120363 PANNELLO
CONTROP. APS/STS/C
53 /
STORM DOOR PANEL
APS / STS / C 53

34576:

HOONVED - ALI SPA



4120705 INVOLUCRO
PORTA C 6 /
CASING DOOR C 6

35556:

HOONVED - ALI SPA

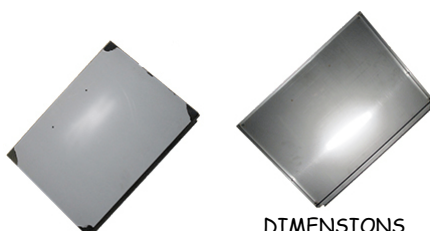

DIMENSIONS
570X420mm

4120248 PORTA
MOD. 1/425 C/MOLLE
INOX /
DOOR MOD. 1/425 C /
SPRING STEEL

GMPO1M:

OMNIWASH SRL -
SOCIETA' A SOCIO
UNICO



4120627 PORTA
MOD. 4Q/82 C/MOLLE
INOX (PR+5 /
DOOR MODEL 4Q / 82 C
/ STEEL SPRINGS (FOR
+ 5

GMPO5MPR5:

OMNIWASH SRL -
SOCIETA' A SOCIO
UNICO

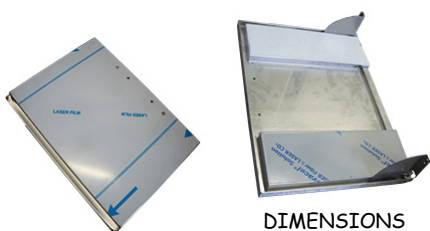

DIMENSIONS
412X555mm

4120612 CRUSCOTT
O BASSO MOD. 4/82
SENZA CAVA /
PANEL LOW MOD. 4/82
NO QUARRY

GMCR55C:

OMNIWASH SRL -
SOCIETA' A SOCIO
UNICO

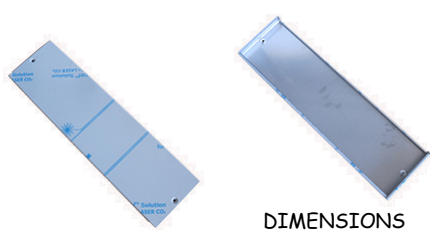

DIMENSIONS
590X165mm

4120279 CRUSCOTT
O BAS 1 ABS GRIGIO
SENZA CAVA ST. 116 /
PANEL FOR MODEL 1
ABS GREY ST.116

GMCR15CPLGR:

OMNIWASH SRL -



SOCIETA' A SOCIO
UNICO

4115834 CRUSCOTT
O BAS 2 ABS GRIGIO
RAL 7011 ST 110 UNI /
DASHBOARD 2 ABS
RAL 7011 ST 110 UNI

GMCR2CPLGR:

OMNIWASH SRL -
SOCIETA' A SOCIO
UNICO



4120473 CRUSCOTT
O BAS. MOD. 2 S/CAVA
/
LOWER PANEL MOD. 2
NO QUARRY

GMCR25CPLGR:

OMNIWASH SRL -
SOCIETA' A SOCIO
UNICO

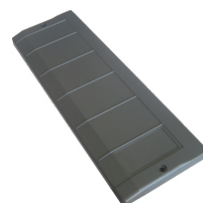

4120497 CRUSCOTT
O BASAMENTO MOD. 1
S/CAVA /
PANEL BASE MOD. 1 S
/ CAVA

GMCR15CPLNR:

OMNIWASH SRL -
SOCIETA' A SOCIO
UNICO

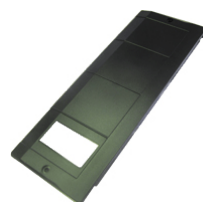

4120341 CRUSCOTT
O BASSO MOD. 1 CON
CAVA /
LOWER PANEL MOD. 1
WITH HOLE

GMCR1CPLBL:

OMNIWASH SRL -
SOCIETA' A SOCIO
UNICO



425X160mm

4120074 CRUSCOTT
O BAS 2 ABS NERO
STAMPO 110 UNI /
PANEL 2 ABS BLACK

GMCR2CPL:

OMNIWASH SRL -
SOCIETA' A SOCIO
UNICO



L=470mm

4120451 PANNELLO
SUPERIORE MOD.
JOLLY /
TOP PANEL MOD.
JOLLY

GMPS15CPL08:

OMNIWASH SRL -
SOCIETA' A SOCIO
UNICO

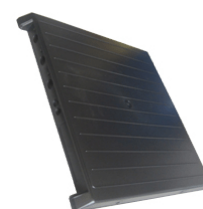

4115889 SPUNTONE
X NASTRO N P.60 /
FINGER FOR BELT
60mm
170217:
COMENDA ALI SPA



4115890 SPUNTONE
P.60 VASSOI NASTRO N
/
CENTRAL FINGER
60mm CONVEYOR
BELT N
170218:
COMENDA ALI SPA



4115473 SUPPORTO
GUIDA INTER.SE
ANGOLO /
INT. GUIDE SUPPORT
SE CORNER
170325:
COMENDA ALI SPA



4115475 SUPPORTO
GUIDA EST.ACR
ANGOLO /
EXT.GUIDE SUPPORT
SE CORNER
170326:
COMENDA ALI SPA



4120606 PATTINO SX
GUIDA LEVA
PORTELLO LFD /
SKID GUIDE LEVER SX
DOOR LFD
180655:
COMENDA ALI SPA



4120609 PATTINO
DX GUIDA LEVA
PORTELLO LFD /
SKID GUIDE LEVER DX
DOOR LFD
180656:
COMENDA ALI SPA



4115251 SUPP.GUIDA
PORTAS.CARIC.ANGOL
/
SUPPORT OF PAWL
BAR GUIDE
170316:
COMENDA ALI SPA



4115470 SUPPORTO
GUIDA PORTASAL.AC-
ACR /
SUPPORT F.PAWL BAR
GUIDE AC
190145:
COMENDA ALI SPA



4120316 SALTARELL
O SE NICHELATO /
SUPPORT
510414:
COMENDA ALI SPA
H510414:
HOONVED - ALI SPA



4115771 SUPPORTO
MANIGLIONE C30-70-
75 /
HANDLE HOLDER
HOOD MECHANICS
C30-70-75
190110:
COMENDA ALI SPA



4115503 SNODO
MANIGL. C75-C140-
C155 /
BUSH C75-C140-C155
191013:
COMENDA ALI SPA



4120650 BATTUTA X
MOLLA
BILANCIAMENTO E
CHIUSURA /
TRIKE FOR SPRING
AND CATCH
307014:
ELETTOBAR



4120203 SQUADRET
TA DX FULCRO B14 /
BRACKET RIGHT
PIVOT B14
00210902:
ELFRAMO SPA



SX=4120204

4120204 SQUADRET
TA SX FULCRO B14
PART /
BRACKET LEFT PIVOT
B14
00210903:
ELFRAMO SPA



DX=4120203

4120061 SNODO
MAN.C75-140-155
C/33439 /
ARTICULATION
JOINTS HANDLE-C75
140-155 C/33439
33438:
HOONVED - ALI SPA



4120454
SALTARELLO GUIDE /
SALTARELLO GUIDES
510425: HOONVED
510425:
COMENDA ALI SPA



4120608 GOMMINO x
CERNIERA PORTA DX /
RUBBER x DOOR
HINGE DX

161406: HOONVED

161406:

COMENDA ALI



4120598 RACCORDO
BRACCIO PPH /
ARM FITTING PPH

908745:

SILANOS SRL



4115223 ANELLO X
MANICOTTO /
HOSE RING

3169:

ARISTARCO SPA



HOSE=2108049

4120024 PASTIGLIA
OTTONE GIRANTE INF.
DIS.835 /
PAD LOWER BRASS
IMPELLER DIS.835

2718:

ARISTARCO SPA



4115803 DISTANZ.
FULCRO INOX DIS.838 /
SPACER PIECE

2733: .

ARISTARCO SPA



4120537 FLANGIA
NODO LAVAGGIO
GL/1040 /
FLANGE NODE
WASHING GL / 1040

2593:

ARISTARCO SPA



1140065 PIANTONE
INF. AF CON CAVA X
ANELLO TENUTA /
WASH ARM HOLDER
AF

4362: A.T.A. SRL



1140104 DADO

FISS.MOZZO
MULIN.LAV.FC /
BUSH COMENDA

191070:

COMENDA ALI SPA

191070:

HOONVED - ALI SPA



4115257 RONDELLA

47,5X25X10,5
MULINELLO
LAVAGGIO /
REEL WASHER
WASHING 47,5X25X10,5

160820:

COMENDA ALI SPA



4115881 ANELLI

TEN.MIM 17X35X7 /
SEAL RING MIM
17X35X7

440408:

COMENDA ALI SPA



4115235 GHIERA X
MUL.LAV.PIATTO
"LC"^{no} /
"RETAIN.LOCK ""LC""

191075:

COMENDA ALI SPA



4115460 GHIERA
BLOC.MUL.C1000/1300"
LC /
RETAIN.LOCK NUT

CENTR.CROSS C140

280409:

COMENDA ALI SPA



4120301 DISCO
PARZIALIZZATORE
ACQUA 500/510/22/44... /
SPACER

199045:

ELETTROBAR



30,9X13X0,8mm

4115671 RONDELLA
ACCIAIO NP /
STAINLESS STEEL
WASHER NP

NP 43-49:

GRUPPO CIMBALI SPA

984036000:

GRUPPO CIMBALI SPA



4115674 RONDELLA
PALA LAV.SUP. NP60 /
WASHING ARM
WASHER NP60

NP60:

GRUPPO CIMBALI



4115682 RONDELLA
SPESS.MM 1,5* /
WASHER MM 1,5
9131293:
GRUPPO CIMBALI SPA
984266000:
GRUPPO CIMBALI SPA



4120405 MILLED
NUT PASSIVATED /
MILLED NUT
PASSIVATED
012402051:
HOBART GmbH



4120385 WASHER /
WASHER
602288:
HOBART GmbH



4120436 DISTANZIA
LE
SUPP.PORTCEST.CAP7 /
SPACER SUPPORT.
DOOR RACKS CAP7
36465:
HOONVED - ALI SPA



4120630 SPANDIACQ
UA POMPA AP. /
DIFFUSER WATER
PUMP AP.
32348:
HOONVED - ALI SPA



44,5X17,7X3mm

4115560 GHIERA
BLOCCAGGIO
MULIN.C140-155 /
BLOCKING JUNCTION
FOR WHIRLPOOL C140-
155
36006:
HOONVED - ALI SPA



4115511 DISCO
GRUPPO CENTRALE /
CENTER SUPPORT
WASHER
33346:
HOONVED - ALI SPA



4120590 GHIERA
DISTANZIALE
RISCIACQUO
ROTAZIONE DX /
DISTANCE NUT RINSE
ROTATION DX
34998:



HOONVED - ALI SPA

4120047 RONDELLA
INOX 17X22 /
INOX WASHER 17X22
104230:
KRUPPS S.R.L.



4120360 "GHIERA
INF. SENZA FORI
""V0"" GRIGIO" /
"NUT LOWER.
WITHOUT HOLES" "V0"
"GREY
LI034PV0GR:
OMNIWASH SRL



4120633 DISTANZIA
LE PER RULLO
ECCENTRICO /
SPACER FOR
ECCENTRIC ROLLER
12281+11497:
ARISTARCO KASTEL
5263EX: ARISTARCO
5263: KRUPPS S.R.L.
12362:
ARISTARCO KASTEL



4120636 FLANGIA
MOTORIDUTTORE
SERIE TR /
FLANGE MOTOR
SERIES TR
5250:
ARISTARCO SPA



4120635 SUPPORTO
MOTORIDUTTORE
SERIE TR /
MOTOR SUPPORT
SERIES TR
5249:
ARISTARCO SPA



4120683 DISTANZIA
LE
TRONCH.FISS.VASCH.E
COR.AC /
SPACER FIXING TANK
AC
160541:
HOONVED - ALI SPA
160541:
COMENDA ALI SPA



4115575 LIMITATOR
E DI COPPIA LC1-AC90-
150 /
TORQUE LIMITER
DEVICE LC1-AC90-150
410407:
COMENDA ALI SPA



1140230 #MOZZO
PER GIRANTE
LAV.GASTRO 1200 /
WASH ARM BOSS
DW10600903:
DIHR-ALI SPA



4120568 SEDE
CUSCINETTO
RIDUTTORE ETE /
GEAR HEAD BEARING
ETE
00095299:
ELFRAMO SPA



4115683 NOTTOLINO
TIRAGGIO MOLLA
NAP* /
DOOR SPRING NAP
986031000:
GRUPPO CIMBALI SPA
9131540:
GRUPPO CIMBALI SPA



1140135 MOZZO
LAV.INF. NAP 43-48* /
HUB WASH/RINSE
ARM NAP 43-48
9131291ex:
GRUPPO CIMBALI SPA
986024000:
GRUPPO CIMBALI SPA



4120164 MOZZO
GIREVOLE C/FISSO /
CENTRAL NUT
0201150:
LAMBER SRL
984403000:
GRUPPO CIMBALI SPA
98402000+9840780:
GRUPPO CIMBALI SPA
9031126+9131026:
GRUPPO CIMBALI SPA
9141434:
GRUPPO CIMBALI SPA
984020000EX:
GRUPPO CIMBALI SPA



4115512 BUSSOLA
RIDUZIONE C43-48 /
REDUCTION BUSH
C43-48
33700:
HOONVED - ALI SPA



1140176 PERNO
RISCACQUO 1205 /
PIN RINSE 1205
0200038:
LAMBER SRL



4115635 SUPPORTO
GUIDA PETTINE /
WASH ARM SUPPORT
66:
ELETTROBAR
DIVISIONE DELLA
EUROTEC SRL



4120678 TAPPO
CHIOCCIOLA
POMPA(2434R) /
PLUG FOR PUMP BODY
(2434R)
480159:
ELETTROBAR
DIVISIONE DELLA
EUROTEC SRL



4120628 FLANGIA A
MANICOTTO 1"1/4
D.110 RIBASS. /
WASH BOSS HOLDER
1"1/4
0201458:
LAMBER DI AFFABA
FRANCESCO & C.



4115541 RACCORDO
ASPIRAZIONE
1000/1300 /
SUCTION JUNCTION
901653:
SILANOS SRL



4115809 DISTANZIA
LE RACC. LAV. N700 /
SPACER FOR N700
908702:
SILANOS SRL



4115438 FLANGIA
COLONNA C95-C155 /
WASH ARM OPPOSITE
SUPPORT C95-C155
180240:
COMENDA ALI SPA



4120508 ANELLO DI
GOCCIOLAMENTO
46/50.. /
RING OF DROPPING
46/50 ..
303029:
ELETTROBAR
DIVISIONE DELLA
EUROTEC SRL



4115838 DEFLETTOR
E MULINELLO SERIE
APS /
DEFLECTOR WASH
ARM SERIES APS
36478:
HOONVED - ALI SPA



DIMENSIONS
49X26X7mm

4115846 COPERCHIO
SCAT.LAV.INF.TURBO /
COVER LOWER WASH
BOX.TURBO
30664:
HOONVED - ALI SPA



4115865 FLANGIA
RACC. SUP.
N45/N50/N700F/N1000 /
UPPER JUNCTION
N45/N50/N700F/N1000
* N45, N50, N700,
N1000:
SILANOS SRL
33M0360:
ANGELO PO GRANDI
CUCINE SPA



4115868 CONTROFL.
ANGIA NORYL MOZZO
SUPERIORE /
FLANGE
901775:
SILANOS SRL



4115767 CUFFIA
PARASPRUZZI PER
P300 /
SPLASH GUARD
FLANGE
20135P:
SISTEMA PROJECT
SERVICE SRL



4120075 FLANGIA
INOX Ø 60 /
STAINLESS STEEL
FLANGE ? 60
1540:
UNIVER-BAR SRL



4120687 RACCORDO
INFER. LAVAGGIO /
WASH LOWER FITTING
3070540:
ANGELO PO GRANDI
CUCINE SPA



4115802 ASS.
FLANGIA BOCCAGLIO
INOX LAVABICCHIERI
/
FLANGE CONICAL
2763:
ARISTARCO SPA



4120339 FLANGIA A
BOCCAGLIO IN
TECNOPRENE /
FLANGE NOZZLE IN
TECNOPRENE
12208:
ARISTARCO SPA



4120543 PARZIALIZZ
ATORE PL. /
SHUTTER PL.
41185:
ELETTOBAR
DIVISIONE DELLA
EUROTEC SRL

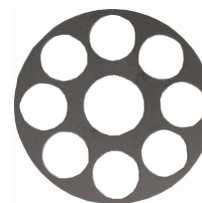

4120689 DISCO
PARZIALIZZATORE
ACQUA /
DISK WATER
RESTRICTOR
199053:
ELETTOBAR
DIVISIONE DELLA
EUROTEC SRL



DIMENSIONS
34X14X0,7mm

4120145 TURBO
DISCO LAVAGGIO 3
GETTI /
DISC TURBO WASH
JETS 3
30557:
HOONVED - ALI SPA

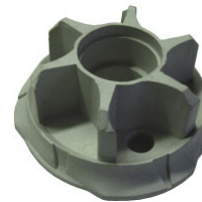

4120694 ROMPIGOR
GO ASPIR.POMPA BC /
ANTIVORTEX DISC
SUCTION PUMP BC
160313:
HOONVED - ALI SPA

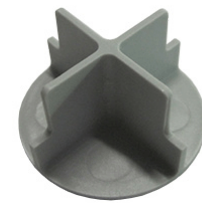

4120676 ROMPIGOR
GO ASPIRAZIONE
POMPA /
ANTIVORTEX DISC
SUCTION PUMP
34659:
HOONVED - ALI SPA



4120465 ANELLO
CENTRAGGIO PIPE
FC06 /
FC06-CENTERING RING
PIPE

190212H:

HOONVED - ALI SPA

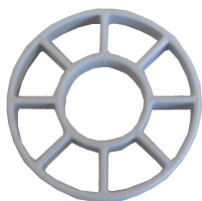

4115909 DISCO
PARZIALIZZAZIONE
ACQUA /
DISK WATER
PARTIALISATION

*:

MBM- EUROTEC SRL -
DIV. COOKING
SERVICE

199043:

ELETTROBAR
DIVISIONE DELLA
EUROTEC SRL



4120574 INSERTO
PER CORPO FISSO
PLASTICA /
INSERT FOR FIXED
BODY PLASTIC

104402: KRUPPS S.R.L.



4120634 CUSCINETT
O 6005/2RS 25x47x12
INOX /
BEARING 6005 DDU
NSK

5568:

ARISTARCO SPA

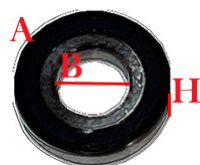

B=25mm, H=12mm,
A=47mm

4120445 CUSCINETT
O PICCOLO /
SMALL BEARING

4041: FABAR SRL



4120446 CUSCINETT
O GRANDE /
BEARING BIG

4042: FABAR SRL



4115733 CUSC.6201-2
RS Z15 INOX /
BERING 6201-2 RS Z15
INOX

H410126:

HOONVED - ALI SPA

410126:

COMENDA ALI SPA



4120249 PATTINO
NYLON PER COLONNE
COMPACT /
NYLON SHOE FOR
COMPACT COLUMN

4715:

UNIVER-BAR SRL



4120038 CUSCINETT
O PER BRACCIO DI
LAVAGGIO /
BEARING FOR
WASHING ARM

62001486:

WINTERHALTER
ITALIA SRL



4120361 CUSCINETT
O BS620590 /
BEARING BS620590



4120372 SPUNTONE
x FINECORSIA NE/2 /
SPIKE LIMIT SWITCH
FOR NE / 2

170238:

COMENDA ALI SPA

H170238:

HOONVED - ALI SPA



4120197 TAPPO
SX.PANN.COM.BETA
246/250 /
SX PLUG

480102:

ELETTROBAR
DIVISIONE DELLA
EUROTEC SRL

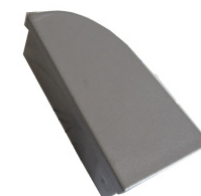

4120448 TAPPO
CAPPELLO
SX.E50/E51/E55 BLUE /
BLUE HAT CAP
SX.E50/E51/E55

480125:

ELETTROBAR
DIVISIONE DELLA
EUROTEC SRL

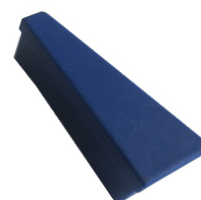

4115917 PARACOLPI
CAPOT /
HOOD BUFFER

80105:

ELETTROBAR
DIVISIONE DELLA
EUROTEC SRL



811112 1 71 6
SLIDING DOOR WHEEL
/
SLIDING DOOR WHEEL
101716: I.T.V. S.A.
1716: I.T.V. S.A.



4115571 TAPPO X
MOZZO LAV RISC.
INF.LAVASTOVIGLIE /
PLUG FOR RINSE ARM
SUPPORT
902351:
SILANOS SRL



4120404 BLOCCHETT
O COLLETTORE
RISCIACQUO CLC2001 /
RINSE COLLECTOR
BLOCK C LC2001
191100:
COMENDA ALI SPA



4120569 INLET PIECE
/
INLET PIECE
012457132:
HOBART GmbH

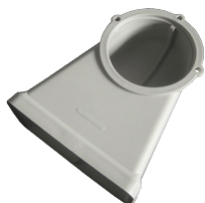

4115421 PORTAFILT
RO DOSATORE
COMENDA /
FILTER SUPPORT
RINSE AID INJECT
191018:
COMENDA ALI SPA



4115447 GHIERA FIL.
ASTA LAVAGGIO AP /
NUT FOR WASH ARM
AP
32282:
HOONVED - ALI SPA



4115072 MORSETTIE
RA FV122/850 TRIFASE
/
TERMINAL BLOCK
THREE PHASE
FV122/850
CEMOS3F:
OMNIWASH SRL -
SOCIETA' A SOCIO
UNICO



4120221 PARAGOCC
E IN PLASTICA PER AL
/
DEFLECTOR DROP
COLLECTING TANK
DOOR
6473:
ARISTARCO SPA



4120675 PIASTRINA
PARA ACQUA /
PLATE WATER
00014024:
ELFRAMO SPA



4115504 SQUADRET
TA CORNICE
CONT.BR.F. /
BRACKET FOR FRAME
331439:
COMENDA ALI SPA

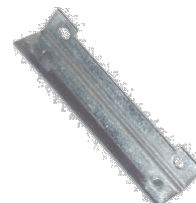

4115513 SQUADRET
TA SOST. POMPA EX
AL /
"BRACKET F. PUMP
"F" ""
331922:
COMENDA ALI SPA



4115941 SUPPORTO
SUP. /
UPPER SUPPORT
0L0055:
ELECTROLUX
PROFESSIONAL
S.P.A.



4120649 FERMO
AGGANCIO PORTA BE /
DOOR LATCH HOOK
BE
00222461:
ELFRAMO SPA



4120486 SUPPORTO
POMPA C34/CE24 /
PUMP SUPPORT
BRACKET
00019537:
ELFRAMO SPA



4120229 SQUADRET
TA X TERMOSTATO /
THERMOSTAT
BRACKET
332821:
HOONVED - ALI SPA

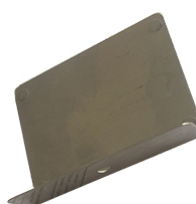

4115581 FLANGIA X
SNODO MANIGL.C70-
C155 /
FLANGE FOR HANDLE
C70-C155

33439:

HOONVED - ALI SPA

191014:

COMENDA ALI SPA



4115921 LEVA INOX
MICROIN. PORTA
LEVA R= 72,8MM /
LEVER STEEL
microswitch. DOOR
HANDLE R = 72.8 MM

CEMP12A:

OMNIWASH SRL -
SOCIETA' A SOCIO
UNICO



4115973 SUPPORTO
CENTR. FILTRI SUP.
MOD. 61-2P INOX /
CENTRAL FILTER
HOLDER MOD. 61-20

LISFC6:

OMNIWASH SRL -
SOCIETA' A SOCIO
UNICO



4115189 SUPPORTO
SX BACINELLA S20 /
LEFT TANK HOLDER
S20

32330609:

RANCIPIO SPA



4120333 DISCO
GRIGLIATO FILTRO
VASCA /
FILTER DISK TANK

31209:

HOONVED - ALI SPA



4120012 IMBUTO
TROPPO PIENO SR /
OVER FLOW FUNNEL
SR

29466:

HOONVED - ALI SPA

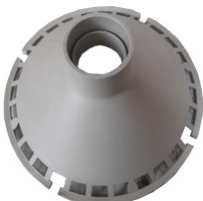

4115271 FASCETTA
A DUE FILI D. 39,7X37,7
/

2 THREADS BAND D.
39,7X37,7

450143:

COMENDA ALI SPA



4115556 GANCIO
SICUR.PORTA AC-ACR
T.N. /
DOOR SECURITY
HOOK

331116:

COMENDA ALI SPA

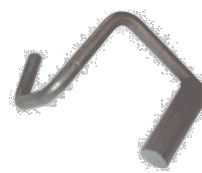

4115361 GUIDA
TUBO DIS. LS028 /
GUIDANCE LS028

DW10203:

DIHR-ALI SPA



4120539 WIRING
HARNESS /
WIRING HARNESS

323905:

HOBART GmbH



4120302 FUNE
D'ACCIAIO D.1,5 X 275 /
WIRE STEEL D.1,5 X
275

390307:

HOONVED - ALI SPA

37441ex:

HOONVED - ALI SPA

390307:

COMENDA ALI SPA



4120419 CATENARIA
CIRCUITO TERRA TB2
L. 4 /
CATENARY CIRCUIT
GROUND TB2 L. 4

CECBCTB2:

OMNIWASH SRL -
SOCIETA' A SOCIO
UNICO



4115420 GHIERA DA
1/2 PER DOSATORE /
"LOCK NUT 1/2"
F.INJECTOR"

170701:

COMENDA ALI SPA



4120346 "SCATOLA
MICRO 62P/S PPL
""V0"" COMP" /
MICROSWITCH 62P/S
PPL ""V0"" COMP"

CE5MP615C:

OMNIWASH SRL -
SOCIETA' A SOCIO
UNICO



4120351 "SCATOLA
MICRO 62P/S PPL
""V0"" /
MICROSWITCH 62P/S
CE5MP62PS:
OMNIWASH SRL -
SOCIETA' A SOCIO
UNICO



4115932 FISSACAVO
ELECTRO TERMINAL
KADO /
CONNECTOR BLOCK
65459018:
RANCLIO SPA
459018:
ELETTROBAR
*:
MBM- EUROTEC SRL -
DIV. COOKING
SERVICE



4120068 ZOCCOLO
OCTAL A VITE
RITARDATORE /
OCTAL SOCKET
SCREW DELAYING
CETF60A:
OMNIWASH SRL

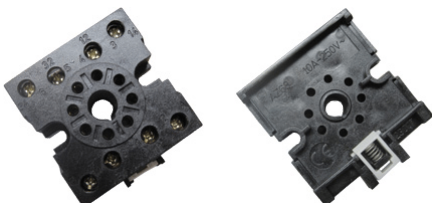

4115488 BUSSOLA
AGGANCIAMO MOLLE "C"
/
HANDLE BUSH C30-70
190607:
COMENDA ALI SPA



4120377 SNODO
AGGANCIAMO MOLLA /
ARTICULATION
JOINT'S SPRING
COUPLING
DW70306:
DIHR-ALI SPA



4115668 PULEGGIA
AGGANCIAMO MOLLA
62P /
PULLEY
ATTACHMENT SPRING
62P
GMML6251:
OMNIWASH SRL -
SOCIETA' A SOCIO
UNICO



4120255 "RACCORD
O ANG. DELRIN F1/4"
F1/8" /
NON-RETURN VALVE
HOSE CONNECTOR D.
4X6mm
12510003:
ELFRAMO SPA



4120458 MOSCHETT
ONE 5x50 /
SNAP 5x50
9682: A.T.A. SRL



4120577 ASTINA
TIRANTE MOLLA
LFD/BC /
HEAD ROD SPRING
LFD / BC
330242:
COMENDA ALI SPA
330242:
HOONVED - ALI SPA



4120319 ASTINA
TIRANTE MOLLA ST /
HEAD ROD SPRING
LFD / BC
37380:
HOONVED - ALI SPA



4120447 PUNTALE X
CONNETTORE(CN5)(GE
T5) /
TOE CAP X
CONNECTOR (CN5) (get
5)
CN7:
ELETTROBAR
DIVISIONE DELLA
EUROTEC SRL



4120593 STAFFA
SUPPORTO GRUPPO
1200 /
BRACKET SUPPORT
GROUP R1200
1202070:
KRUPPS S.R.L.



4120196 CONO PER
SAC A' POCHE /
CONE FOR SAC
A' POCHE
18239:
HOONVED - ALI SPA



4115486 CAVALLOT
TO+RULLO MANIGLIA
/
"GUIDE FOR DOOR
""C"" + ROLLER FOR
""C"" DOOR GUIDE"
33446+33448:
HOONVED - ALI SPA
190637+190638:
COMENDA ALI SPA



4115522 MANETTA
DI TENUTA FILTRO
VASCA /
TANK FILTER LOCK
KNOB

31210:
HOONVED - ALI SPA



4115565 SPINA
ELASTICA INOX 6X30 /
ELAST.ROLL PINS
6X30 DIN STAINL.ST

451121:
COMENDA ALI SPA



4115567 SUPPORTO
TRAINO AC-ACR /
DRIVE ASSEMBLY AC-
ACR

620144ex:
COMENDA ALI SPA
*: HOONVED - ALI



4120317 TERMOSIFO
NE LAVABICCHIERI ø
32x255 mm /
HEAT EXCHANGER ø
32x255 mm

10156: FABAR SRL



4120457 TIRANTE
PESO AT /
ROD WEIGHT AT

9668: A.T.A. SRL



4120530 RUBBER
BUSHING /
RUBBER BUSHING

8855001:
HOBART GmbH



4120614 Gommino
passatubo piccolo /
RUBBER

4083:
UNIVER-BAR SRL



4115657 GHIERA
RISCIACQUO DELRIN
NAP /
RINSE FERRULE
DELRIN NAP

986007000:
GRUPPO CIMBALI SPA
9131286:



GRUPPO CIMBALI SPA

4120570 STRAINER /
STRAINER

012453774:
HOBART GmbH



4120335 ALBERO
TRAINO NE
COIB.MONTATO /
PULLING SHAFT

620680:
COMENDA ALI SPA



4115785 SUPP.PIEDE
PLAST. /
PLASTIC FOOT
SUPPORT

33532:
HOONVED - ALI SPA
160509:
COMENDA ALI SPA



4115855 SERRATUB
O DIS.506 /
UNION NUT 506

2450:
ARISTARCO SPA



4115871 GRUPPO
COLL.2 ELETTRIV. /
TWIN SOLENOID
VALVE MANIFOLD

620121:
COMENDA ALI SPA



4120580 ASSIEME
NODO LAVAGGIO
INFERIORE GL 1040 /
TOGETHER JUNCTION
WASHING LOWER GL
1040

2703:
ARISTARCO SPA



4120615 GRUPPO
VASCA INOX Q35/40S/I
/ TANK STEEL GROUP
for Q35 / 40S / I

06090EI: FABAR SRL



4120050 MANDRINO
CPL DIAM.6,35 X
SONDA /
PROBE-HOLDER D. 6,35
27203:
HOONVED - ALI SPA



4120251 SUPP.ROVES
C.BOTTONE COPPA 5-
01 /
SUPPORT
160549:
COMENDA ALI SPA



4120329 KIT
REVISIONE
ELETTROV.SIRAI X
L140 B5 /
KIT FOR VALVE SIRAI
X L140 B5
09136A: FABAR SRL



4115791 DISTANZIA
LE FILETT.INT.14X1 /
NIPPLE 14X1mm
17933:
HOONVED - ALI SPA



4120350 PUNTALE
ISOL. AST. MICRO
GRIGIO RAL /
MICROSWITCH AGLET
CEMPPIBGR:
OMNIWASH SRL -
SOCIETA' A SOCIO
UNICO



4115903 FRIZIONE
PER LAVASTOVIGLIE
A TRAINO, COM /
DISH-WASHER
CLUTCH
REB6008503:
LOTUS SPA
6008503:
ELETTROBAR
DIVISIONE DELLA
EUROTEC SRL
*:
MBM- EUROTEC SRL -
DIV. COOKING
SERVICE



4120489 #SETACCIO
MOD.40 VERSIONE
.2003 /
SIEVE FILTER MODEL
VERSION 40 .2003
DW60545:
DIHR-ALI SPA



4115969 LEVA PER
ECONOMIZ.ACR /
LEVER FOR
ECONOMIZER SE SNL
320698:
COMENDA ALI SPA

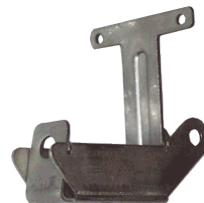

1140187 TIRANTE
INOX A45 DIS.448 /
ROD STEEL A45
DIS.448
2154:
ARISTARCO KASTEL
SPA



1140203 PERNO
LAVAGGIO GL/1040-
1240 /
PIN WASHING GL /
1040-1240
2587:
ARISTARCO KASTEL
SPA



1141457 TIRANTE
SUPERIORE
RISCIACQUO /
ROD UPPER RINSE
2708:
ARISTARCO KASTEL
SPA



1140013 PERNO
GIRANTE AT/ALP44
ATA /
WHEEL PIN AT/ALP44
ATA
9631: A.T.A. SRL



1140035 PERNO
TESTA ROTANTE /
WASH ARM SHAFT
7103: A.T.A. SRL



1140107 ALBERO
MULINELLO C
95,155,165 /
SHAFT FOR WASH
ARM C 95,155,165
340499:
COMENDA ALI SPA



1140111 PERNO
CERNIERA B-F- G65-
G165 COMENDA /
DOOR SHAFT B-F-G65-
G165 COMENDA

341218:

COMENDA ALI SPA



1141355 ALBERINO
RISCIACQUO FC2006 /
RINSE ARM SHAFT

342790:

COMENDA ALI SPA



1141151 PERNO
MICRO
PORT.LVBCUSTOM /
PIN FOR
MICROSWITCH

381002:

COMENDA ALI SPA



1140194 ASSE DI
RISCIACQUO /
RINSE ARM SHAFT

DW10651:

DIHR-ALI SPA



1141146 BULLONE
INOX M14X39 / BOLT
STAINLESS M14X39

DW75201: DIHR-ALI
SPA



1140228 PERNO
RISCIACQUO
INFERIORE E55 93mm
/RINSE LOWER PIN -
E55 93MM

325076: ELETTROBAR

DIVISIONE DELLA
EUROTEC SRL



4120293 PERNO
PETTINE RISCIACQUO
RIVER /
PIN COMB RINSE
RIVER

80380:

ELETTROBAR
DIVISIONE DELLA
EUROTEC SRL



1141258 PROLUNGA
PERNO PETTINE DI
RISCIACQUO /
RINSE ARM SHAFT

325063:

ELETTROBAR
DIVISIONE DELLA
EUROTEC SRL



1141243 PERNO PER
LANCIA DI
RISCIACQUO
GIREVOLE /
ROLL PIN

DLP52

: COLGED

*: MBM- EUROTEC
SRL - DIV. COOKING
SERVICE

926130:

ELETTROBAR
DIVISIONE DELLA
EUROTEC SRL



1141282 PERNO
RISC.SUP.X5 /
PIN UPPER RINSE X5

325071:

ELETTROBAR
DIVISIONE DELLA
EUROTEC SRL



1140239 PERNO
BRACCIO LAVAGGIO
RISCIACQUO /
PIN ARM
WASHING/RINSE

79023:

ELETTROBAR
DIVISIONE DELLA
EUROTEC SRL



1141431 PROLUNGA
PERNO RISC.SUP.X5 /
RINSE ARM SHAFT

325070:

ELETTROBAR
DIVISIONE DELLA
EUROTEC SRL



1141327 PERNO IN
ACCIAIO
INOSSIDABILE PER
LANCIA /
STAINLESS STEEL PIN
FOR ARM

80282:

ELETTROBAR
DIVISIONE DELLA
EUROTEC SRL



1140179 PROLUNGA
PERNO /
EXTENSION PIN
69282:
ELETTROBAR
DIVISIONE DELLA
EUROTEC SRL



1140201 PERNO
CERNIERA SPORTELLO
55 /
DOOR HINGE PIN 55
929018:
ELETTROBAR
DIVISIONE DELLA
EUROTEC SRL



3114002 MOVIMENT
O GIRELLO 35-4OR /
BASKET HOLDER
SUPPORT PIN 35-4OR
322007:
ELETTROBAR
DIVISIONE DELLA
EUROTEC SRL



3114003 PROLUNGA
PERNO MOV. GIRELLO
/
BASKET HOLDER
SUPPORT PIN
EXTENSION
325044:
ELETTROBAR
DIVISIONE DELLA
EUROTEC SRL



1140133 PERNO
PORTA NAP* /
DOOR SHAFT NAP*
9131541:
GRUPPO CIMBALI SPA
986032000:
GRUPPO CIMBALI
SPA



4120601 ALBERINO
BRACCIO RISCIAQUO
55 mm /
SHAFT-RINSE ARM
55MM
296092:
HOBART GmbH



1140117 PERNO
GIRELLO D. 17 /
SHAFT D.17
15234:
HOONVED - ALI SPA



1141433 ALBERO
RISC.SUPER.AP 60 /
RINSE PIPE AP 60
17915:
HOONVED - ALI SPA



1140192 PROLUNGA
ALBER.MULIN.INFERI
ORE /
EXTENSION SHAFT
LOWER REELS
37612:
HOONVED - ALI SPA



1141370 PERNO
MULINELLO
RISCIAQUO /
RINSE ARM PIN
34384:
HOONVED - ALI SPA



1140251 PERNO
ASTA RISCIAQUO
COMPLETA /
PIN ROD RINSE
15942:
HOONVED - ALI SPA



1140151 ALBERO
GIRELLO CPL S/E 52 /
BASKET HOLDER
SUPPORT PIN CPLCS/E
52
20142:
HOONVED - ALI SPA



1140240 ALBERO
RISCIAQUO
INFERIORE INOX APS
H=133 /
LOWER RINSE SHAFT
INOX APS H=133
36467:
HOONVED - ALI SPA



1141473 ALBERO
RISCIAQUO
INFERIORE AP 43-48 /
LOWER RINSE SHAFT
17913:
HOONVED - ALI SPA



1140223 PERNO
GIRANTE 87MM /
IMPELLER PIN 87MM
104076: KRUPPS S.R.L.



1140224 PERNO
INOX Ø22 L=56 PER
GRUPPO INOX
LAVAPIATTI A
CAPPOTTA /
PIN INOX Ø22 L = 56
FOR STEEL GROUP A
DISHWASHER CAP
104075: KRUPPS S.R.L.



1141435 PERNO
CORPO DOSATORE /
BOLT FOR DOSING
PUMP
C0004M112:
MACAP SRL



1140180 PERNO
FERMO PORTA 4/DS
15X35 /
PIVOT DOOR LATCH
4/DS 15x35
E4M2000:
OEM ALI SPA



1140254 ALBERO
TRASMISSIONE BM/2 /
SHAFT BM/2
KF05100:
OEM ALI SPA



Ø=25X195mm

1140003 PERNO
PORTELLO IME /
DOOR SHAFT
*:
OMNIWASH SRL -
SOCIETA' A SOCIO
UNICO
AM412NTM:
OMNIWASH SRL -
SOCIETA' A SOCIO
UNICO



1140169 PERNO
INOX 6X60 MICRO
MOD.6S DIS. /
STAINLESS STEEL PIN
6X60 MICRO MOD. 6S
DIS.
CEMP6S:
OMNIWASH SRL -
SOCIETA' A SOCIO
UNICO



1140170 PERNO
INOX PORTA 2 C/M.
DIAM. 8X109 /
STAINLESS STEEL
DOOR PIN 2 C/M.
DIAM. 8X109
AM212NTM:
OMNIWASH SRL -
SOCIETA' A SOCIO
UNICO



1140168 PERNO
INOX AZ. MICRO 6X40
6 DIS. /
STAINLESS STEEL PIN
AZ. MICRO 6X40 6 DIS.
CEPAMP6S:
OMNIWASH SRL -
SOCIETA' A SOCIO
UNICO



1140006 PERNO
PORTELLO MM100 /
DOOR PIN MM100
25124046:
RANCILIO SPA



1141365 PERNO
GIRANTE RISC.
PLASTICA /
PIN PLASTIC
IMPELLER RINSE
908771:
SILANOS SRL



1141268 PERNO
LAVAGGIO
SUPERIORE N1000 V.T /
UPPER WASH ARM PIN
908707:
SILANOS SRL



1141275 PERNO LAV.
INF. N700 /
PIN FOR BOTTOM
WASH ARM
ASSEMBLY
908705:
SILANOS SRL



L=155mm

1140050 PERNO
GIRANTE LAVAGGIO
1300 SILANOS /
WASH PIN UPPER 1300
SILANOS
904750:
SILANOS SRL



1140164 PERNO
LAVAGGIO INFERIORE
/
LOWER WASH PIN
904753:
SILANOS SRL



1141347 PERNO
LAVAGGIO
SUPERIORE
N700/N45/N50 /
PIN UPPER WASH
N700/N45/N50
904799:
SILANOS SRL



1140102 COPPIGLIE
INOX D.2X12 UNI 1336 /
PIN D2X12
451002:
COMENDA ALI SPA
451002:
HOONVED - ALI SPA



4120383 PIN 3X15 /
PIN 3X15
602886:
HOBART GmbH



1140149 DADO
BLOCCA PIASTRINA
A35-A40-A50 DIS.1321 /
NUT LOCKING PLATE
A35-A40-A50 DIS.1321
3164:
ARISTARCO KASTEL
SPA

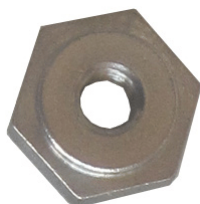

1141145 DADO OT
M18 ES22X14 /
NUT M18 OT ES22X14
DW75202:
DIHR-ALI SPA



1141514 #DADO
BLOCCA VASCHETTA /
NUT FOR BLOCKING
BASIN
DW60305:
DIHR-ALI SPA

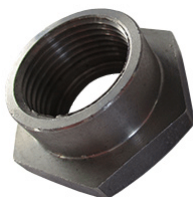

1141196 DADO
ACC.INOX.3/4 AP 48* /
STAINLESS STEEL
NUT 3/4 AP 48*
98426500:
GRUPPO CIMBALI SPA
9085814EX:
GRUPPO CIMBALI SPA



1141050 DADO M8X1
X TERMOCOPPIA
GIUNTO FILETTATO /
NUT FOR
THERMOCOUPLE M8x1
MA939300:
MARENO INDUSTRIE
ALI SPA
BN6A012300:
OLIS DIVISIONE DI
ALI GROUP SPA -
939300:
SILKO ALI SPA
X15900:
GIGA GRANDI
CUCINE SRL
533009800:
LOTUS SPA



1141001 DADO
OTTONE 3/8 GAS ALTO
/
BRASS NUT 3/8 GAS
D038EX:
OMNIWASH SRL -
SOCIETA' A SOCIO
UNICO
D038A:
OMNIWASH SRL -
SOCIETA' A SOCIO
UNICO



1141351 NUT / NUT
Z1AC016:
SCOTSMAN ICE SRL

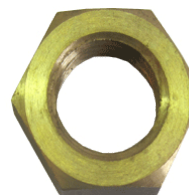

1141161 DADO
GOMITO PER PILETTA
SCARICO /
NUT 1" H 5mm
17060:
SISTEMA PROJECT
SERVICE SRL



1141358 "DADO
INOX 1" "G. PILETTA
SCARICO" /
STAINLESS STEEL NUT
1"
1533:
UNIVER-BAR SRL



1140200 "Dado inox
Fil. 3/8" "G" /
Stainless steel nut thread
3/8" "G"
3155:
UNIVER-BAR SRL

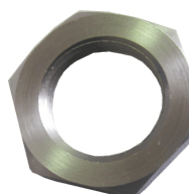

1141248 DADO 3/8"
PER TERMOSTATO /
"NUT 3/8"" FOR
THERMOSTAT"

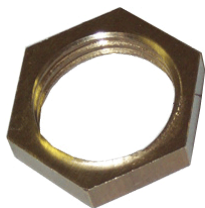

1141246 DADO 1/2
PER TERMOSTATO /
NUT 1/2 FOR
THERMOSTAT



1140148 TESTINA
PERNO A40-A50
DIS.1322 /
HEAD STUD A40-A50
DIS.1322



3165:
ARISTARCO KASTEL
SPA

1141321 GHIERA
FISSAGGIO
MULINELLO /
RING NUT FIXING
REEL



261009:
COMENDA ALI SPA
H261009:
HOONVED - ALI SPA

1141135 VITE
FISSAGGIO GRUPPI
RISCIACQUO DIHR /
KNURLED SCREW



DW11101A:
DIHR-ALI SPA

1141137 VITE
FISSAGGIO GRUPPI
M8X35 DIHR /
SCREW M8x35 GROUPS
DIHR



DW11101/B:
DIHR-ALI SPA

1141330 VITE
ZIGRINATA M8 /
KNURLED SCREW M8



2535:
UNIVER-BAR SRL

1140028 DISTANZIA
LE C/MOLLA 1-2
11,5X9,5 /
SPACER RING BUSH 1-
2 11,5X9,5



AM012EX:
OMNIWASH SRL -
SOCIETA' A SOCIO
UNICO
AM012M:
OMNIWASH SRL -
SOCIETA' A SOCIO
UNICO

1140241 PERNO
BLOCCA
PORTACESTELLO /
PIN LOCK SUPPORT-
BASKET



903444EX:
SILANOS SRL
903439: SILANOS
SRL

1141402 DADO
PILETTA SCARICO ABS
NSF /
DRAIN PLUG ABS NSF

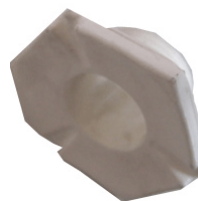

K00004:
ARISTARCO KASTEL
SPA

1141331 DADO X
PILETTA NYLON /
NUT X WASTE NYLON



203:
ARISTARCO KASTEL
SPA

1141493 DADO
RACCORDI
BACINELLA /
NUT FOR BASIN
CONNECTIONS



10159:
BREMA ICE MAKERS
SPA

1141129 GHIERA PER
TRONCHETTO
ASPIRAZIONE /
METAL RING



160783:
COMENDA ALI SPA
160771:
COMENDA ALI SPA

1141512 DADO X
TAPPO PLASTICA
FIL.M10 /
NUT FOR CAP FIL.M10



160789:
COMENDA ALI SPA
160789:
HOONVED - ALI SPA

1141157 CONTRODA
DO DA 1/2" /
"NUT 1/2" PLASTIC"
180109:
COMENDA ALI SPA
H180109:
HOONVED - ALI SPA



1141138 DADO P646
FISSAGGIO TORRETTA
T.4 LS /
FIXING NUT P646
TURRET T.4 LS
DW540010:
DIHR-ALI SPA
DW540069:
DIHR-ALI SPA

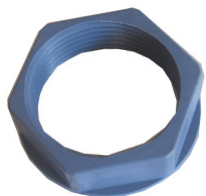

1141136 DADO PER
MOZZO GIRANTE 11S
DIHR /
NUT IMPELLER
BEARINGS FOR 11S
DIHR
DW75317:
DIHR-ALI SPA



1141186 DADO IN
PLASTICA 1-1/4 /
PLASTIC NUT 1-1/4
CDP2: COLGED
417081:
ELETTROBAR
DIVISIONE DELLA
EUROTEC SRL



1141188 DADO PER
SUPPORTO MOZZO
LANCIA DI LAVAGGIO
L51/52 /
NUT L51/52
80314ex:
ELETTROBAR
DIVISIONE DELLA
EUROTEC SRL
CDP258: COLGED
926128:
ELETTROBAR
DIVISIONE DELLA
EUROTEC SRL



1141299 DADO PER
COLLETTORE
LAVAGGIO /
NUT FOR WASH
COLLECTOR
417038:
ELETTROBAR
DIVISIONE DELLA
EUROTEC SRL



1141049 DADO 1
POLL. PLASTICA /
PLASTIC NUT 1"
984023000:
GRUPPO CIMBALI SPA
9085412:
GRUPPO CIMBALI SPA



1141107 DADO 1" 1/4
PLASTICA /
PLASTIC NUT 1"1/4
RR000PRAQ9:
ELECTROLUX
PROFESSIONAL
S.P.A.
9085415:
GRUPPO CIMBALI SPA
984024000:
GRUPPO CIMBALI SPA



1141195 DADO 1
POLLE.1/2 PLAST. /
PLASTIC NUT 1"1/2
977015000:
GRUPPO CIMBALI SPA
9085419:
GRUPPO CIMBALI SPA



1141175 DADO X
RACCORDO A "T" /
NUT
30436:
HOONVED - ALI SPA



1141428 DADO ASTA
LAVAGGIO C.T. MOD
2/4 GRIGIO RAL 7040 /
RINSE ARM NUT FOR
MOD.2/4
GL34T27ABGR:
OMNIWASH SRL
GL34T27AB:
OMNIWASH SRL -

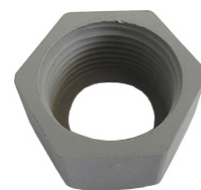

1141014 DADO
RACCORDO GIREVOLE
IME /
PLASTIC NUT IME
GP026BBGR:
OMNIWASH SRL
GP026B:
OMNIWASH SRL

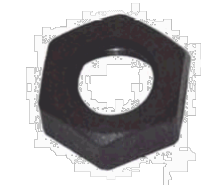

1141004 DADO 1"1/4
GAS /
PLASTIC NUT 1 1/4
"GAS
DP114GR:
OMNIWASH SRL -
SOCIETA' A SOCIO
UNICO



1141022 DADO 1"1/4
RESISTENZA VASCA
62P /
"NUT 1"1/4 FOR TANK
HEATING ELEMENT
62P"
D0114:
OMNIWASH SRL -
SOCIETA' A SOCIO
UNICO



1141153 FERMO PER
TIRANTE BC BR /
LOCKFOR TIE BC BR
190644:
COMENDA ALI SPA



1141236 DADO
BATTUTA SPORTELLO
PER LAVASTOVIGLIE /
END STOP
*: MBM- EUROTEC
SRL - DIV. COOKING
SERVICE
REB417041:
LOTUS SPA
REB417041: COLGED
417041:
ELETTROBAR
DIVISIONE DELLA
EUROTEC SRL



1141007 VITE
FISSAGGIO TENDINA
BREMA /
SCREW
20009:
BREMA ICE MAKERS
SPA



1141414 TORNILLO
PRESOSTATO /
EYE BOLT
Z203013000:
FAGOR
INDUSTRIALE S.R.L.
12024222:
FAGOR
INDUSTRIALE S.R.L.



1141242 VITE
REGOLAZIONE
DOSATURA M 8 X 70 /
DOSAGE ADJUSTMENT
SCREW M 8 X 70
S000VIA01QQQ:
MAZZER LUIGI SPA



1141490 VITE
REGOLAZIONE
DENSITA' ZINCATA /
ZINC PLATED
DENSITY ADJUSTING
SCREW
2280016700:
UGOLINI SPA



1141496 VITE DI
FISSAGGIO GRIGIA
SPALLA POSTERIORE /
SCREW
2280022202:
UGOLINI SPA
*: UGOLINI SPA



1141501 DISCO
ANTISFILAMENTO
SERIE TR * /
ANTIEXTRACTION
DISK
5259: KRUPPS S.R.L.
5259:
ARISTARCO KASTEL
SPA



DIMENSIONS
33X6X2mm

1140190 PERNO
FISSAGGIO SUPPORTO
PIATTO
RHENINGHAUS START
350 /
STUD PLATE FIXING
SUPPORT Rheninghaus
START 350



1141203 DADO PER
CROCERA 4 VIE /
NUT
L3381: LUXIA SRL



1141010 DADO PL
FISSAGGIO GIRANTE
LT-S /
CAP KNURLED SCREW
LT-S
38123207:
RANCILIO SPA



1141148 ANELLO
SPACCATO D. 18X3 /
RING D. 18X3
7136: A.T.A. SRL



1141152 TIRANTE
M5X250PORTA F
LAVLINE /
DOOR PIN TIE BAR
330231:
COMENDA ALI SPA



1141154 ANELLO
DISTANZIALE
23X14,5X4mm /
SPACING RING FOR
TURBINE 23X14,5X4mm
18345:
HOONVED - ALI SPA



DIMENSIONS
23X14,5X4mm

1141499 ASSIEME
GRUPPO ECCENTRICO
TR 1200/1650 /
ECCENTRIC
ASSEMBLY TR
1200/1650
10093: KRUPPS S.R.L.
10093:
ARISTARCO KASTEL
SPA



3118014 RACCORDO
A PIPA /
PIPE JOINT
38121034:
RANCILIO SPA
030151:
MAGISTER SISTEMA
CAFFE' SRL

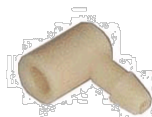

3118002 SUPPORTO
RISCIACQUO MOD. 4/82
/
RINSE JUNCTION
MOD. 4/82
LI533FOT:
OMNIWASH SRL -
SOCIETA' A SOCIO
UNICO



3118010 "T"
RISCIACQUO UNI 43 /
T HOLDER JUNCTION
UNI 43
30431:
HOONVED - ALI SPA



3118017 RACCORDO
T RISCIACQUO 2
RIDUZ. /
2 WAYS T RUBBER
HOLDER JUNCTION
31659:
HOONVED - ALI SPA



3118003 RACCORDO
ENTRATA 90G. CQ /
ENTRANCE JUNCTION
90G. CQ
LI027:
OMNIWASH SRL -
SOCIETA' A SOCIO
UNICO



3118015 RACCORDO
A T NERO /
BLACK T JUNCTION
66022400:
SCOTSMAN DIV.
FRIMONT SPA



3118021 T ASTA
LAVAGGIO 3 VIE /
T JUNCTION
26310:
HOONVED - ALI SPA



3118035 RACCORDO
A T LAVAGGIO SUP
LAVAST MOPLEN BLU
/
UPPER WASHING T
JUNCTION MOPLEN
BLU
833711: TEIKOS SRL



Ø=45es. - 40in.,
Ø=33es. - 28in.

3118022 RACCORDO
A T MOPLEN GRIGIO /
T JUNCTION
190307:
COMENDA ALI SPA



3118023 "RACCORDO
A ""T"" SAP*" /
2 WAYS T HOLDER
JUNCTION SAP
986511000:
GRUPPO CIMBALI
SPA



4115854 PRESA DI
PRESSIONE /
T FITTING
2503:
ARISTARCO SPA



4120289 GRUPPO
VALVOLA DI SFIATO X
PS LA50 /
VALVE ASSEMBLY
144995:
ELETTROBAR
DIVISIONE DELLA
EUROTEC SRL



4120368 GR.VALVOL
A DI SFIATO X PS CRP /
VALVE ASSEMBLY
VENT X PS CRP
144994:
ELETTROBAR
DIVISIONE DELLA
EUROTEC SRL



4115427 PORTAGOM
MA A T D. 13 /
T RUBBER-HOLDER
D.13

180403:
COMENDA ALI SPA



2108125 PORTAGOM
MA A T D 115 /
TEE NIPPLE D.11,5 -
RINSE ASSEMBLY

33276:
HOONVED - ALI SPA
180413:
COMENDA ALI SPA



4115032 RACCORDO
A T SILANOS /
T HOLDER JUNCTION
SILANOS

905382:
SILANOS SRL



3118018 PORTAGOM
MA A "T"X BY-PASS-ç /
"RUBBER HOLDER
""T""X BY-PASS-?"

180411:
COMENDA ALI SPA



4115696 PORTAG.T
DOSAT.ATT.CENTR.RI
D. /
T HOLDER JUNCTION

H180408:
HOONVED - ALI SPA
180408:
COMENDA ALI SPA
7947: A.T.A. SRL



3118025 RACC. 3
VIE+ RACCORDO
DOSATORE /
3 WAYS JUNCTION 1/8

905408:
SILANOS SRL



3118007 RACCORDO
A "T" /
T HOLDER JUNCTION



3118013 RACCORDO
A 3 VIE DOSATORE /
3 WAYS T RUBBER
HOLDER JUNCTION

905381:
SILANOS SRL



4115027 RACCORDO
PORTAGOMMA T 1 VIA
/
RUBBER HOLDER
CONNECTION T 1 WAY

GB017:
OMNIWASH SRL -
SOCIETA' A SOCIO
UNICO



4115267 PORTAGOM
MA ADOPPIA T
COMENDA /
DIVIDER COMENDA

H180415:
HOONVED - ALI SPA
180415:
COMENDA ALI SPA



3118005 RACCORDO
PORTAGOMMA T 2 VIE
/
2 WAYS T RUBBER
HOLDER JUNCTION

GB055:
OMNIWASH SRL -
SOCIETA' A SOCIO
UNICO



4115958 "RACCORDO
""Y"" 3 VIE
PORTAGOMMA
STAMPO 86 UNI" /
Y-FITTING

GR6183:
OMNIWASH SRL -
SOCIETA' A SOCIO
UNICO



4120137 "DEVIATOR
E A ""Y"" PLASTICA" /
"DEVIATOR" "Y"
"PLASTIC"

1599:
UNIVER-BAR SRL



4120426 RIPARTITOR
E A 3 VIE /
3-WAY DISTRIBUTOR

45104200:
MODULAR SPA



4115395 DERIVAZIO
NE 4 VIE AISI D.10X1
PORTA /
DIVIDER 4-WAYS
DW15151:
DIHR-ALI SPA
3001: A.T.A. SRL



4116441 FASCETTA
IN INOX M7 D.7-11 /
TIGHTING PIPE
CLAMP 7-11



4116440 FASCETTA
IN INOX M10 D.10-17 /
TIGHTING PIPE
CLAMP 10-17
450102:
COMENDA ALI SPA



4116003 FASCETTA
STRINGITUBO 12-20 /
TIGHTING PIPE
CLAMP 12-20
923026:
BRICE ITALIA SRL
46003701*:
SCOTSMAN DIV.
FRIMONT SPA
69000081:
RANCILIO SPA
450103:
COMENDA ALI SPA
12010036:
FAGOR
INDUSTRIALE S.R.L.



4116055 FASCETTA
25-40 /
TIGHTING PIPE
CLAMP 25-45



4116054 FASCETTA
D. 20/32 /
TIGHTING PIPE
CLAMP 30-32



4116170 FASCETTA
INOX M40 D.40-60 /
STAINLESS STEEL
CLAMP M40 D.40-60
H450135:
HOONVED - ALI SPA
05100003:
ELFRAMO SPA
0620040604:
MODULAR SPA
450135:
COMENDA ALI SPA



4116198 GIUNTO
RAPIDO " L " 2X4-1/8"
VIT /
"RAPID JOINT "" L ""
2X4-1/8"" VIT"



4116199 GIUNTO
RAPIDO " T " 2X4-1/8"
VIT /
"RAPID JOINT "" T ""
2X4-1/8"" VIT"



4116201 GIUNTO
RAPIDO " I " 2X4-1/8"
VIT /
"RAPID JOINT "" I ""
2X4-1/8"" VIT"



4116260 FASCETTA
100X2,5MM
NEUTRA/NATURAL /
BAND 100X2,5MM
NEUTRA/NATURAL



4116261 FASCETTA
140X2,5MM
NEUTRA/NATURAL /
BAND 140X2,5MM
NEUTRA/NATURAL



3106050 ASSIEME
BOILER 5 LITRI /
ASSEMBLY BOILER 5
LITRE
2995:
ARISTARCO KASTEL
SPA



DIAMETER 136 mm,
LENGTH 360 mm

3106027 ASSIEME
BOILER A 35 /
ASSEMBLY BOILER A
35

00011725:
ARISTARCO KASTEL
SPA

3161ex:
ARISTARCO KASTEL
SPA

11725:
ARISTARCO KASTEL
SPA



3106096 ASS.
BOILER 12L LP /
BOILER 12L LP

4412:
ARISTARCO KASTEL
SPA



3106012 BOILER AL /
BOILER AL

7890: A.T.A. SRL



3106107 BOILER AF /
BOILER AF

4496: A.T.A. SRL



3106068 BOILER /
BOILER

9564: A.T.A. SRL



3106014 BOILER
COMENDA BC/BR/FC43
/

BOILER COMENDA
BC/BR/FC43

330340:
COMENDA ALI SPA



3106015 BOILER
LAVABICCHIERI BHC /
GLASS WASHERS
BOILER BHC

330353:
COMENDA ALI SPA

330374:
COMENDA ALI SPA

37383EX:
HOONVED - ALI SPA

330374:



HOONVED - ALI SPA

3106042 BOILER
C1000/1300-FC-LC /
BOILER C1000/1300-FC-
LC

330342:
COMENDA ALI SPA



3106037 BOILER
LAVABICCH.B10-19
COMENDA /
BOILER
GLASSWASHER B10-
B19T COMENDA

330334:
COMENDA ALI SPA



3106093 BOILER PER
FC2006 /
BOILER FC2006

330372:
COMENDA ALI SPA



3106081 BOLLITORE
CPL C 53 60 E /
BOILER CPL C 53 60 E

330368:
COMENDA ALI SPA

36558:
HOONVED - ALI SPA



3106067 BOILER
D.150 COIB.AC91=122 /
BOILER D.150
COIB.AC91=122

330320:
COMENDA ALI SPA

H330320:
HOONVED - ALI SPA



3106103 BOILER
LAVAP. GE HV 34857 /
BOILER FOR Pot washer
GE 34857

330355:
COMENDA ALI SPA



3106016 BOILER
SEZ. QUADRA BREAK
TANK /
SQUARE SECTION
BOILER BREAK TANK

330352:
COMENDA ALI SPA



3106051 BOILER

D.200X640 DUE
RESIST. /
BOILER D.200X640

330339:

COMENDA ALI SPA

H330339:

HOONVED - ALI SPA



3106060 BOILER

D.230 NE 3
RESIST.COIB /
BOILER D.230

330322:

COMENDA ALI SPA



3106085 BOILER AX

250/540 SUP.DOPPIO
316 /
BOILER AX 250/540

DW3007013:

DIHR-ALI SPA



L=530mm, Ø=160mm

3106018 BOILER

COMPLETO GASTRO
250 /
COMPLETE BOILER
GASTRO 250

DW26905:

DIHR-ALI SPA



DIAMETER=140mm,
LENGTH=335mm

3106023 BOILER

SERIE 50 DIHR /
BOILER DIHR

DW150905:

DIHR-ALI SPA



3106025 BOILER

160X490 MO G11S-
LPGS100 DIHR /
BOILER 160X490 MO
G11S-LPGS100 DIHR

DW22002:

DIHR-ALI SPA



3106110 BOILER

ATMOSFERICO /
ATMOSPHERIC
BOILER

049632:

ELECTROLUX
PROFESSIONAL
S.P.A.



Ø= 200 mm,
LENGTH= 365 mm

3106029 BOILER PER LAVABICCHIERI / GLASS WASHERS BOILER

*: MBM- EUROTEC
SRL - DIV. COOKING
SERVICE

104039:

ELETTROBAR
DIVISIONE DELLA
EUROTEC SRL

REB104039:

LOTUS SPA

REB104039: COLGED

999244:

ELETTROBAR
DIVISIONE DELLA
EUROTEC SRL

*: MBM- EUROTEC
SRL - DIV. COOKING
SERVICE



3106054 BOILER

DVGW /
BOILER DVGW

104027ex:

ELETTROBAR
DIVISIONE DELLA
EUROTEC SRL

999243:

ELETTROBAR
DIVISIONE DELLA
EUROTEC SRL

*: MBM- EUROTEC
SRL - DIV. COOKING
SERVICE

*: MBM- EUROTEC
SRL - DIV. COOKING
SERVICE

REB104027:

LOTUS SPA

REB104027: COLGED



3106055 BOILER 12

LITRI /
BOILER 12 LT.

*: MBM- EUROTEC
SRL - DIV. COOKING
SERVICE

80389:

ELETTROBAR
DIVISIONE DELLA
EUROTEC SRL



3106061 BOILER PER MACCHINA A CAPOT / BOILER

*: MBM- EUROTEC
SRL - DIV. COOKING
SERVICE

926026:

ELETTROBAR
DIVISIONE DELLA
EUROTEC SRL



3106115 BOILER CRP
LA50 Ø=144mm -
L403mm /
BOILER ø 142x402 mm
104061:
ELETTRORBAR
DIVISIONE DELLA
EUROTEC SRL

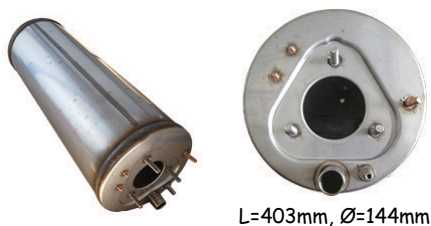

L=403mm, Ø=144mm

3106058 BOILER PER
LAVASTOVIGLIE A
TRAINO /
BOILER
927067:
ELETTRORBAR
DIVISIONE DELLA
EUROTEC SRL
*: MBM- EUROTEC
SRL - DIV. COOKING
SERVICE



3106059 BOILER PER
LAVASTOVIGLIE /
BOILER
*: MBM- EUROTEC
SRL - DIV. COOKING
SERVICE
104026:
ELETTRORBAR
DIVISIONE DELLA
EUROTEC SRL



3106062 BOILER PER
LAVASTOVIGLIE /
BOILER
*: MBM- EUROTEC
SRL - DIV. COOKING
SERVICE
104906:
ELETTRORBAR
DIVISIONE DELLA
EUROTEC SRL
*: MBM- EUROTEC
SRL - DIV. COOKING
SERVICE
*: ELETTRORBAR
DIVISIONE DELLA
EUROTEC SRL



3106072 BOILER SQ
885/240 RICAMBI /
BOILER SQ 885/240
00010500:
ELFRAMO SPA



3106094 BOILER
BD14 /
BOILER BD14
00222040:
ELFRAMO SPA



3106065 BOILER ET
3 RESIST. /
BOILER ET 3 HEATING
ELEMENT
00075810:
ELFRAMO SPA



3106113 BOILER
COMPLETO
MOD.T39I/S-Q40I/S ø
145x305 mm /
BOILER ø 145x305 mm
10157B: FABAR SRL

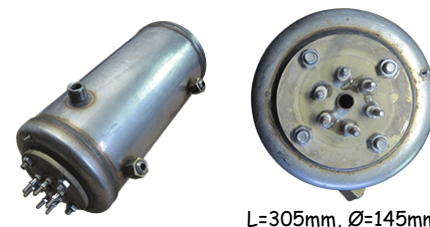

L=305mm, Ø=145mm

3106106 BOILER
SILENT /
BOILER SILENT
977516000:
GRUPPO CIMBALI
SPA
9131699:
GRUPPO CIMBALI
SPA



3106046 BOILER X
RICAMBIO TS 53-60 /
BOILER TS 53-60
21336:
HOONVED - ALI SPA



3106036 BOLLITORE
CPL C-ST5 53-60 /98 /
BOILER CPL C-ST5 53-
60 /98
34596:
HOONVED - ALI SPA



3106099 BOILER
HC3-HC4 /
BOILER HC3-HC4
36713/1:
HOONVED - ALI SPA



3106116 BOLLITORE
C 35E-C43/46 E /
BOILER C 35E-C43/46 E
36713:
HOONVED - ALI SPA



L=360mm, Ø=124mm

3106038 BOILER
C35-C/CR/STS 43-48 /
BOILER C35-C/CR/STS
43-48

35426+35484+2008:

HOONVED - ALI SPA

18683:

HOONVED - ALI SPA



3106090 BOLLITORE
CPL EDI /
BOILER CPL EDI

34857:

HOONVED - ALI SPA



3106075 BOLIER
D.140X475 TRIFASE /
STAINLESS STEEL
BOILER

800421: KRUPPS S.R.L.

800420:

KRUPPS S.R.L.



3106102 BOILER
INOX BR160 /
BOILER STEEL BR160

950420:

KRUPPS S.R.L.



3106076 BOILER
INOX - STAINLESS
STEEL BOILER /
STAINLESS STEEL
BOILER

210420: KRUPPS S.R.L.

600421: KRUPPS S.R.L.

600420:

KRUPPS S.R.L.



3106079 BOILER
INOX BR85 /
STAINLESS STEEL
BOILER BR85

205420:

KRUPPS S.R.L.



3106092 BOILER
INOX - STAINLESS
STEEL BOILER /
STAINLESS STEEL
BOILER

205421: KRUPPS S.R.L.

207420:

KRUPPS S.R.L.



3106109 BOILER
MOD. 1 MINIMOLLY
COMPLETO 116X322M /
BOILER MOD. 1
MINIMOLLY
COMPLETE 116X322M

GB1MM:

OMNIWASH SRL -
SOCIETA' A SOCIO
UNICO



DIAMETER= 120 mm,
LENGTH= 330 mm

3106039 BOILER M. 1
NT COMP 140X350MM /
BOILER M. 1 NT COMP
140X350MM

GB11NT:

OMNIWASH SRL -
SOCIETA' A SOCIO
UNICO



3106043 BOILER M 2
DEP 140x350 /
BOILER M 2 DEP
140x350

GB21:

OMNIWASH SRL -
SOCIETA' A SOCIO
UNICO



3106047 BOILER 4/82
IME 140 Ø x 425 mm /
BOILER 4/82 IME

GB4821F:

OMNIWASH SRL -
SOCIETA' A SOCIO
UNICO



3106064 BOILER M.
62P TRI NT COMP
160X440MM /
BOILER M. 62P TRI NT
COMP 160X440MM

GB413FNT:

OMNIWASH SRL -
SOCIETA' A SOCIO
UNICO



3106048 BOILER
MOD.62 TRIF D.160 L
440MM /
BOILER MOD. 62 3-
PHASES

GB413F:

OMNIWASH SRL -
SOCIETA' A SOCIO
UNICO



3106097 BOILER M2
NT COMPLETO
140X390 /
M2 COMPLETE BOILER
NT 140X365

GB21NTPR5:

OMNIWASH SRL -
SOCIETA' A SOCIO
UNICO



3106104 BOILER M.
4/82 TRI COMPLETO
150X425MM /
BOILER M. 4/82 THREE
PHASE COMPLETE
150X425MM
GB4823F:
OMNIWASH SRL -
SOCIETA' A SOCIO
UNICO



3106013 BOILER 024-
030-N27 /
BOILER 024-030-N27
900355:
SILANOS SRL



3106033 BOILER 600-
700-800-900 /
BOILER 600-700-800-
900
900353:
SILANOS SRL



3106105 BOILER
020/N19/N22/N28/E35/E4
0 /
BOILER
020/N19/N22/N28/E35/E4
0
900368:
SILANOS SRL



3106117 BOILER
600/700/N45/N50/N90
5LT. /
BOILER
600/700/N45/N50/N90
5LT.
900384:
SILANOS SRL



Ø=125mm, L=400mm

3106053 BOILER
020/N19/N22/N28 V.T. /
BOILER
020/N19/N22/N28 V.T.
900351:
SILANOS SRL



3106078 BOILER
INOX MIX/TOP /
STAINLESS STEEL
BOILER MIX/TOP
3272:
UNIVER-BAR SRL



3106080 BOILER
INOX ERGON/MIDI40 /
BOILER INOX
ERGON/MIDI40
1526:
UNIVER-BAR SRL



3106083 BOILER
INOX
MIDI50/LOGOS/OMEG
A/COSMO/COMPACT /
BOILER INOX MIDI50 /
LOGOS / OMEGA /
COSMO / COMPACT
3326:
UNIVER-BAR SRL



8111011 CERNIERA
PORTA
LAVASTOVIGLIE
SILANOS /
DISH-WASHER DOOR
HINGE SILANOS
901245:
SILANOS SRL



8111102 ASSIEME
CERNIERA PORTA SX
AP/AE - FINITO /
ASSEMBLY HINGE
DOOR SX AP / AE -
FINISHED
11499:
ARISTARCO KASTEL
SPA



8111103 ASSIEME
CERNIERA PORTA DX
AP/AE - FINITO /
ASSEMBLY HINGE
DOOR DX AP / AE -
FINISHED
11498:
ARISTARCO KASTEL
SPA



8111045 CERNIERA
PORTA ATA AL45 /
DOOR HING ATA
AL45
AL45: A.T.A. SRL



8111019 CERNIERA
DX BC/FC43/FLAV /
HINGE DX BC / FC43 /
FLAV
441108:
COMENDA ALI SPA



8111020 CERNIERA
SX BC/FC43/FLAV /
HINGE LEFT BC / FC43
/ FLAV
441107:
COMENDA ALI SPA



8111022 CERNIERA
PER PORTINA FC /
DOOR HINGE FC
MACHINES
321807:
COMENDA ALI SPA



8111083 CERNIERA
X PORTINA B-F /
DOOR HINGE B-F
321802:
COMENDA ALI SPA



8111024 ASSIEME
CERNIERA DX PER
PORTA /
HINGE RIGHT
DW150210:
DIHR-ALI SPA



8111025 ASSIEME
CERNIERA SX PER
PORTA /
HINGE LEFT
DW150211:
DIHR-ALI SPA



8111082 CERNIERA
SPORTELO LP92 /
DOOR HINGE LP92
35060:
ELETTROBAR
DIVISIONE DELLA
EUROTEC SRL



8111063 CERNIERA
PORTA SX.11 /
LEFT DOOR HINGE 11
311005CR:
ELETTROBAR
DIVISIONE DELLA
EUROTEC SRL



8111061 CERNIERA
SUPERIORE /
UPPER HINGE
085754:
ELECTROLUX
PROFESSIONAL
S.P.A.



8111085 CERNIERA
/
HINGE
087669:
ELECTROLUX
PROFESSIONAL
S.P.A.



8111086 CERNIERA
KIT /
HINGE SET
087666EX:
ELECTROLUX
PROFESSIONAL
S.P.A.
092983:
ELECTROLUX
PROFESSIONAL
S.P.A.



8111108 CERNIERE
PORTELLA LP70
COPPIA (RICAMBIO) /
DOOR HINGE
00065309:
ELFRAMO SPA



8111098 CERNIERA
PORTELLA BE SX
ASSIEME /
DOOR HINGE
ASSEMBLY SX - BE-
00222629:
ELFRAMO SPA



8111099 CERNIERA
PORTELLA BE DX
ASSIEME /
DOOR HINGE
ASSEMBLY DX - BE-
00222626:
ELFRAMO SPA



8111056 BLOCCO IN
PVC PER CERNIERA
MANIGLIA INF. /
HANDLE HING LOCK
1203020:
KRUPPS S.R.L.



8111028 RULLINO
SPORTELO 40X10X8 /
ROLLER DOOR
40X10X8
DW10800244:
DIHR-ALI SPA



TUBI FLEX INOX / STAINLESS STEEL FLEX PIPES



CODICE S&P S&P CODE	DIMENSIONI DIMENSIONS	TIPO TYPE	CODICE S&P S&P CODE	DIMENSIONI DIMENSIONS	TIPO TYPE
2110004	FF 3/8 L=450mm	A CONICO A CONICAL	2110028	FF 3/8 L=1800mm	A CONICO A CONICAL
2110032	FF 3/8 L=500mm	A CONICO A CONICAL	2110029	FF 3/8 L=2000mm	A CONICO A CONICAL
2110053	FF 3/8 L=600mm	A CONICO A CONICAL	2110036	FF 1/8 L=370mm	B PIANO B FLAT
2110011	FF 3/8 L=800mm	A CONICO A CONICAL	2110048	FF 1/4 L=280mm	B PIANO B FLAT
2110005	FF 3/8 L=1000mm	A CONICO A CONICAL	2110106	FF 1/4 L=500mm	B PIANO B FLAT
2110012	FF 3/8 L=1200mm	A CONICO A CONICAL	2110167	FF 3/8 L=280mm	B PIANO B FLAT
2110006	FF 3/8 L=1500mm	A CONICO A CONICAL	2110016	FF 3/8 L=800mm	B PIANO B FLAT
2110055	FF 3/8 L=1600mm	A CONICO A CONICAL			



CODICE S&P S&P CODE	DIMENSIONI DIMENSIONS	TIPO TYPE	CODICE S&P S&P CODE	DIMENSIONI DIMENSIONS	TIPO TYPE
2110043	FC-F 3/8 L=500mm	A CONICO A CONICAL	2100024	FC-F 3/8 L=1000mm	B PIANO B FLAT
2110015	FC-F 3/8 L=1000mm	A CONICO A CONICAL	2110042	FC-F 3/8 L=1500mm	B PIANO B FLAT
2110014	FC-F 3/8 L=1500mm	A CONICO A CONICAL	2110007	FC-F 3/8 L=2000mm	B PIANO B FLAT
2110063	FC-F 3/8 L=1600mm	A CONICO A CONICAL	2110056	FC-F 3/4 L=1000mm	B PIANO B FLAT
2110013	FC-F 3/8 L=2000mm	A CONICO A CONICAL	2110050	FC-F 3/4 L=1500mm	B PIANO B FLAT
2110025	FC-F 3/8 L=370mm	B PIANO B FLAT	2110147	FC-F 3/4 L=2000mm	B PIANO B FLAT
2110047	FC-F 3/8 L=500mm	B PIANO B FLAT	2110096	FC 3/4 PIANO-FLAT F 3/8 CONICO-CONICAL L=1000mm	C PIANO / FLAT - CONICO / CONICAL



CODICE S&P S&P CODE	DIMENSIONI DIMENSIONS	CODICE S&P S&P CODE	DIMENSIONI DIMENSIONS
2110107	FF 1/2 L=1000mm PIANO - FLAT	2110105	FF 1/2 L=2000mm PIANO - FLAT
2110108	FF 1/2 L=1200mm PIANO - FLAT	2110180	FF 1/2 L=8500mm PIANO - FLAT
2110035	FF 1/2 L=1500mm PIANO - FLAT	2110179	FF 1/2 L=16000mm PIANO - FLAT



CODICE S&P S&P CODE	DIMENSIONI DIMENSIONS
2110045	F 3/8 PIANO/PLANE - M 1/2 L=1500mm

CODICE S&P S&P CODE	DIMENSIONI DIMENSIONS
2110095	F 3/4 PIANO/PLANE - F3/8 CONICO/CONICAL L=500mm

TUBI DI CARICO / LOAD PIPES

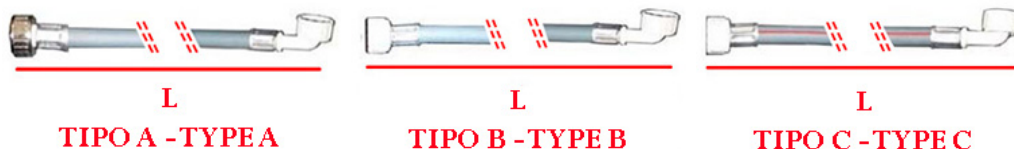

CODICE S&P S&P CODE	DIMENSIONI DIMENSIONS	TIPO TYPE	CODICE S&P S&P CODE	DIMENSIONI DIMENSIONS	TIPO TYPE
2110030	FC-F 3/4 L=1200mm	A PIANO A FLAT	2110033	FC-F 3/4 L=2000mm	C PIANO / C FLAT ACQUA CALDA / HOT WATER
2110008	FC-F 3/4 L=1500mm	B PIANO B FLAT	2110040	FC-F 3/4 L=2000mm	B PIANO B FLAT
2110169	FC-F 3/4 L=1500mm	C PIANO / C FLAT ACQUA CALDA / HOT WATER	2110041	FC-F 3/4 L=3000mm	B PIANO B FLAT

TUBI DI SCARICO / DRAIN PIPES

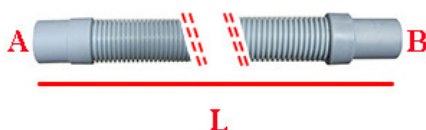

CODICE S&P S&P CODE	DIMENSIONI DIMENSIONS	CODICE S&P S&P CODE	DIMENSIONI DIMENSIONS
2109001	A=21mm B=19mm L=1500mm	2109063	A=31mm B=19mm L=2000mm
2109002	A=28mm B=24mm L=1500mm	2109023	A=35mm B=28mm L=3000mm
2109012	A=30mm B=24mm L=2000mm	2109003	A=35mm B=32mm L=2000mm
		2109062	A=41mm B=35mm L=2000mm

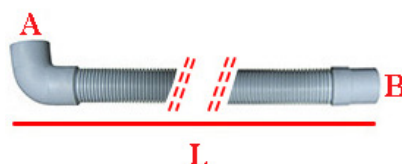

CODICE S&P S&P CODE	DIMENSIONI DIMENSIONS	CODICE S&P S&P CODE	DIMENSIONI DIMENSIONS
2109011	A=21mm B=19mm L=1500mm	2109066	A=31mm L=1500mm
2109039	A=21mm L=2000mm	2109052	A=40mm L=1500mm
2109036	A=22mm B=18mm L=2500mm	2109043	A=41mm B=32mm L=1600mm
2109037	A=22mm B=22mm L=1500mm	2109022	A=42mm L=2000mm
2109051	A=28mm B=20mm L=1800mm	2109065	A=47mm L=1500mm
2109004	A=28mm B=24mm L=1500mm	2109045	A=60mm B=45mm L=1500mm
2109059	A=19mm		

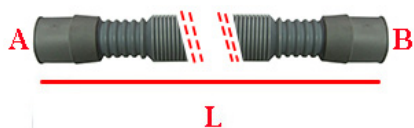

ESTENSIBILE - EXTENSIBLE

CODICE S&P S&P CODE	DIMENSIONI DIMENSIONS
2109009	A=21mm B=19mm L=600-2000mm
2109010	A=39mm B=24mm L=600-2000mm

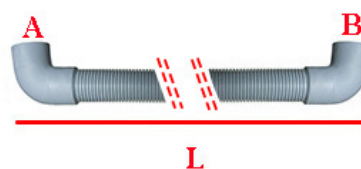

CODICE S&P S&P CODE	DIMENSIONI DIMENSIONS
2108317	A=20mm B=20mm L=350mm

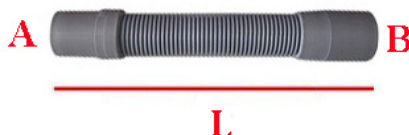

CODICE S&P S&P CODE	DIMENSIONI DIMENSIONS	CODICE S&P S&P CODE	DIMENSIONI DIMENSIONS
2109035	A=17mm B=17mm L=130mm	2109053	A=19mm B=19mm L=174mm
2108229	A=18mm B=21mm L=173mm	2109041	A=19mm B=19mm L=280mm
2108227	A=18mm B=22mm L=205mm	2108228	A=21mm B=21mm L=177mm

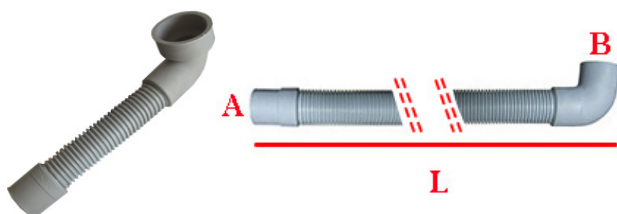

CODICE S&P S&P CODE	DIMENSIONI DIMENSIONS
2108333	A=33mm B=52mm L=260mm

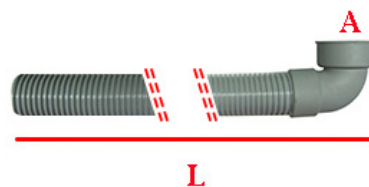

CODICE S&P S&P CODE	DIMENSIONI DIMENSIONS
2109030	A=51mm L=2000mm



SPIRALATO
SPIRALLED



VENDITA AL METRO
SELLING AT METER

CODICE S&P S&P CODE	DIMENSIONI DIMENSIONS	CODICE S&P S&P CODE	DIMENSIONI DIMENSIONS
2110185	Ø=12mm	2109025	Ø=18mm
2110003	Ø=14mm	2110082	Ø=20mm
2109024	Ø=16mm	2110174	Ø=35mm

TUBI / PIPES



PVC



VENDITA AL METRO
SELLING AT METER

CODICE S&P S&P CODE	DIMENSIONI DIMENSIONS	COLORE COLOR	CODICE S&P S&P CODE	DIMENSIONI DIMENSIONS	COLORE COLOR
2110091	Ø=4X6mm	TRASPARENTE TRASPARENT	2110092	Ø=5X7,5mm	TRASPARENTE TRASPARENT
2110170	Ø=4X6mm	ROSSO RED	2110083	Ø=8X12mm	TRASPARENTE TRASPARENT
2110171	Ø=4X6mm	VERDE GREEN	2109055	Ø=18X24mm	VERDE GREEN
2109026	Ø=4X7mm	TRASPARENTE TRASPARENT			



**GOMMA
RUBBER**

**VENDITA AL METRO
SELLING AT METER**

CODICE S&P S&P CODE	DIMENSIONI DIMENSIONS	COLORE COLOR	CODICE S&P S&P CODE	DIMENSIONI DIMENSIONS	COLORE COLOR
2110085	Ø=5X9mm	NERO BLACK	2109005	Ø=10X17mm	NERO - BLACK FOOD QUALITY
2110137	Ø=5X12mm	NERO BLACK	2110002	Ø=10X17mm	NERO BLACK
2110093	Ø=6X9mm	NERO BLACK	2110139	Ø=25X35mm	NERO BLACK
2110001	Ø=8X17mm	NERO - BLACK FOOD QUALITY			



TEFLON

**VENDITA AL METRO
SELLING AT METER**

CODICE S&P S&P CODE	DIMENSIONI DIMENSIONS	CODICE S&P S&P CODE	DIMENSIONI DIMENSIONS
2110079	Ø=3X5mm	2108130	Ø=6,3X9,5mm
2110080	Ø=4X6mm		



SILICONE

**VENDITA AL METRO
SELLING AT METER**

CODICE S&P S&P CODE	DIMENSIONI DIMENSIONS	CODICE S&P S&P CODE	DIMENSIONI DIMENSIONS
2110149	Ø=3X8mm	2110071	Ø=5X8mm
2110151	Ø=4X8mm	2110078	Ø=8X12mm



**SANTOPRENE
SANTOPREN**

**VENDITA AL METRO
SELLING AT METER**

CODICE S&P S&P CODE	DIMENSIONI DIMENSIONS	CODICE S&P S&P CODE	DIMENSIONI DIMENSIONS
1123022	Ø=4X7mm	1123027	Ø=6X9mm
2110150	Ø=4,8X8mm	2110148	Ø=6,2X10,5mm

CESTI IN PLASTICA / PLASTIC BASKETS



CON ANELLO
WITH RING

SENZA ANELLO
WITHOUT RING

CON ANELLO
WITH RING

SENZA ANELLO
WITHOUT RING

CODICE S&P S&P CODE	DIMENSIONI DIMENSIONS	TIPO TYPE	CODICE S&P S&P CODE	DIMENSIONI DIMENSIONS	TIPO TYPE
5101092	Ø=350mm H=170mm	A	5101095	Ø=380mm H=170mm	B
5101091	Ø=350mm H=160mm	B	5101079	Ø=380mm H=160mm	D
5101070	Ø=360mm H=130mm	C	5101116	Ø=400mm H=170mm	A
5101006	Ø=360mm H=170mm	C	5101115	Ø=400mm H=170mm	B
5101096	Ø=380mm H=170mm	A			

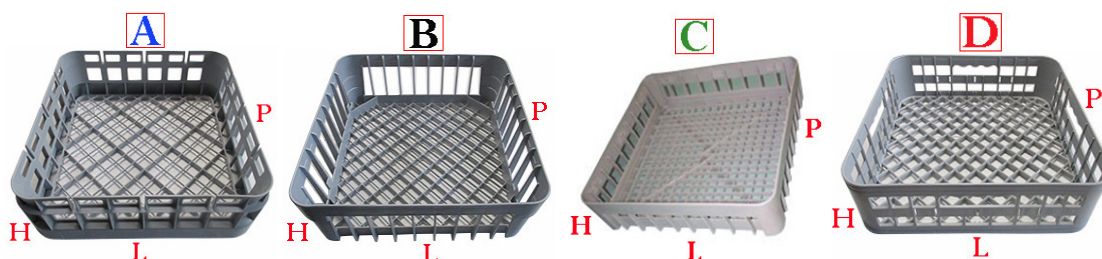

CODICE S&P S&P CODE	DIMENSIONI DIMENSIONS	TIPO TYPE	CODICE S&P S&P CODE	DIMENSIONI DIMENSIONS	TIPO TYPE
5101080	L=350mm P=350mm H=150mm	A	5101120	L=390mm P=390mm H=150mm	A
5101008	L=350mm P=350mm H=150mm	B	5101077	L=400mm P=400mm L=110mm	C
5101130	L=370mm P=370mm H=150mm	D	5101103	P=400mm L=400mm H=120mm	D
5101074	L=380mm P=380mm H=150mm	B	5101081	L=400mm P=400mm H=150mm	A

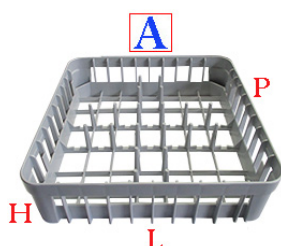

CODICE S&P S&P CODE	DIMENSIONI DIMENSIONS	TIPO TYPE
5101117	L=400mm P=400mm H=150mm	A

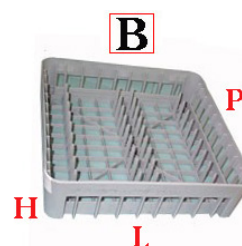

CODICE S&P S&P CODE	DIMENSIONI DIMENSIONS	TIPO TYPE
5101075	L=400mm P=400mm H=110mm	B



CODICE S&P S&P CODE	DIMENSIONI DIMENSIONS	TIPO TYPE
5101101	L=450mm P=450mm H=105mm	A

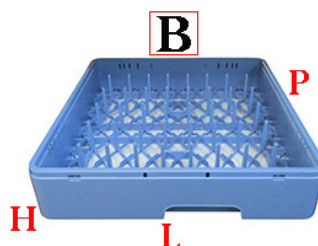

CODICE S&P S&P CODE	DIMENSIONI DIMENSIONS	TIPO TYPE
5101100	L=450mm P=450mm H=105mm 14 PIATTI - DISHES	B

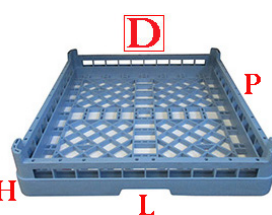
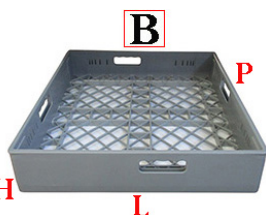
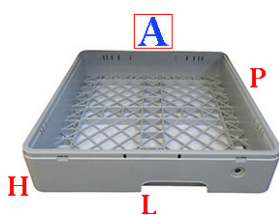

CODICE S&P S&P CODE	DIMENSIONI DIMENSIONS	TIPO TYPE	CODICE S&P S&P CODE	DIMENSIONI DIMENSIONS	TIPO TYPE
5101083	L=500mm P=500mm H=100mm	A	5101102	P=500mm L=500mm H=105mm	C
5101104	P=500mm L=500mm H=105mm	B	5101123	L=500mm P=500mm H=100mm	D

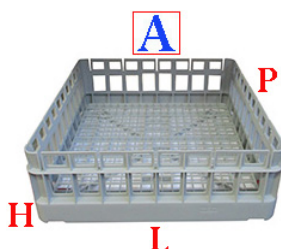

CODICE S&P S&P CODE	DIMENSIONI DIMENSIONS	TIPO TYPE
5101125	L=500mm P=500mm H=150mm	A

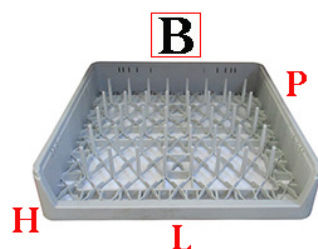

CODICE S&P S&P CODE	DIMENSIONI DIMENSIONS	TIPO TYPE
5101073	L=500mm P=500mm H=110mm 8 VASSOI - DISHES	B

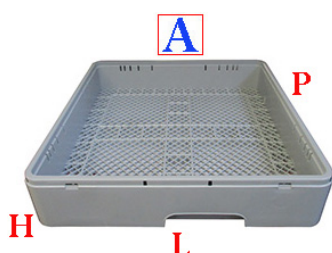

CODICE S&P S&P CODE	DIMENSIONI DIMENSIONS	TIPO TYPE
5101082	L=500mm P=500mm H=110mm	A

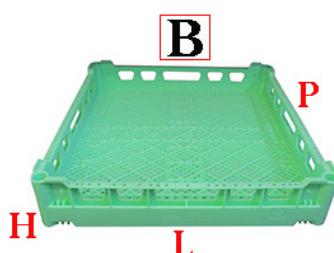

CODICE S&P S&P CODE	DIMENSIONI DIMENSIONS	TIPO TYPE
5101010	L=500mm P=500mm H=105mm	B



CODICE S&P S&P CODE	DIMENSIONI DIMENSIONS	TIPO TYPE	CODICE S&P S&P CODE	DIMENSIONI DIMENSIONS	TIPO TYPE
5101084	L=500mm P=500mm H=110mm 16 PIATTI - DISHES	A	5101126	L=500mm P=500mm H=100mm 12-18 PIATTI - DISHES	C
5101105	P=500mm L=500mm H=105mm 16 PIATTI - DISHES	B	5101124	L=500mm P=500mm H=100mm 10-16 PIATTI - DISHES	D

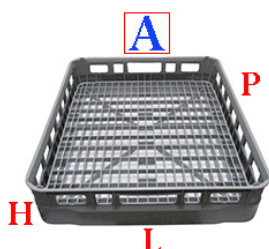

CODICE S&P S&P CODE	DIMENSIONI DIMENSIONS	TIPO TYPE
5101141	L=400mm P=600mm H=110mm	A

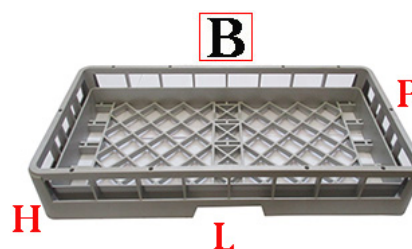

CODICE S&P S&P CODE	DIMENSIONI DIMENSIONS	TIPO TYPE
5101134	L=500mm P=250mm H=185mm	B

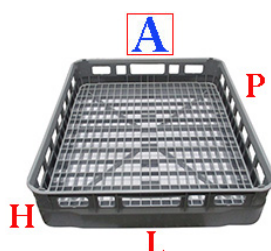

CODICE S&P S&P CODE	DIMENSIONI DIMENSIONS	TIPO TYPE
5101138	L=500mm P=600mm H=185mm	A
5101139	L=500mm P=600mm H=185mm	B

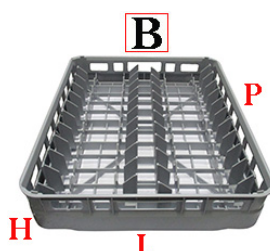

CODICE S&P S&P CODE	DIMENSIONI DIMENSIONS	TIPO TYPE
5101140	L=500mm P=600mm H=185mm VASSOI	C

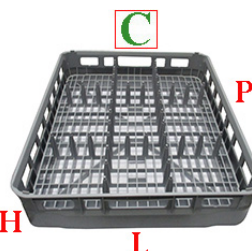

CESTELLI PORTAPOSATE / CUTLERY-RACK BASKETS

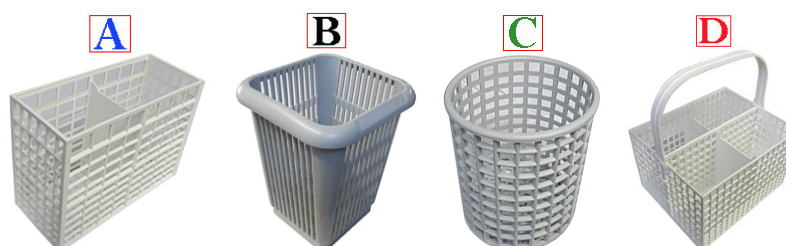

CODICE S&P S&P CODE	DIMENSIONI DIMENSIONS	TIPO TYPE	CODICE S&P S&P CODE	DIMENSIONI DIMENSIONS	TIPO TYPE
5101001	55X130mm H=100mm	A	5101013	110X110mm H=140mm	B
5101031	Ø=105mm H=120mm	C	5101002	150X180mm H=120mm	D

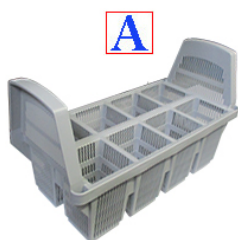

CODICE S&P S&P CODE	DIMENSIONI DIMENSIONS	TIPO TYPE
5101007	200X430mm H=150mm 8 SPAZI - SPACES	A



CODICE S&P S&P CODE	DIMENSIONI DIMENSIONS	TIPO TYPE
5101097	230X485mm H=145mm 8 SPAZI - SPACES	B

INSERTI / INSERTS

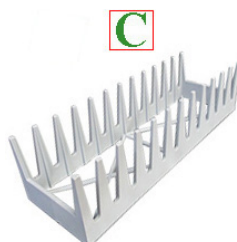
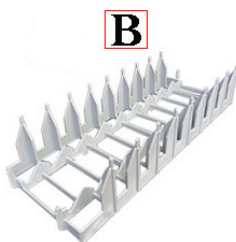
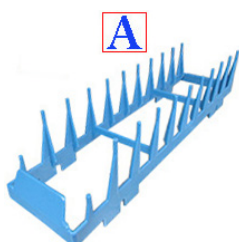

CODICE S&P S&P CODE	DIMENSIONI DIMENSIONS	TIPO TYPE	CODICE S&P S&P CODE	DIMENSIONI DIMENSIONS	TIPO TYPE
5101132	L=292mm 12 PIATTINI - DISHES	C	5101068	L=365mm 10 PIATTINI - DISHES	A
5102015	L=310mm 15 PIATTINI - DISHES	D	5101129	L=370mm 9 PIATTI - DISHES	B
5102016	L=350mm 17 PIATTINI - DISHES	D	5102094	L=405mm 20 PIATTINI - DISHES	D

ACCESSORI / ACCESSORIES



5101077

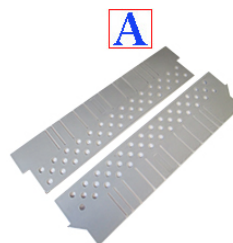

5101076

CODICE S&P S&P CODE	DESCRIZIONE DESCRIPTION	TIPO TYPE
5101076	DIVISORIO SUPERIORE E INFERIORE PER CESTO 5101077 400X400mm - UPPER AND INFERIOR PARTITION FOR BASKET 5101077 400X400mm	A



CODICE S&P S&P CODE	DESCRIZIONE DESCRIPTION	TIPO TYPE
5101131	SGOCCIOLATOIO PER CESTO 400X400mm - BASKET DRAINER 400X400mm	A

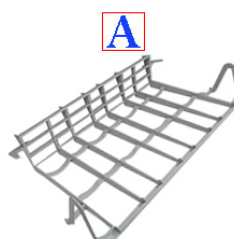

5101128

CODICE S&P S&P CODE	DESCRIZIONE DESCRIPTION	TIPO TYPE
5101128	INSERTO BICCHIERI PER CESTO 5101081 400X400mm – GLASSES INSERT FOR BASKET 5101081 400X400mm	A

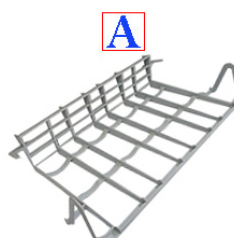

5101127

CODICE S&P S&P CODE	DESCRIZIONE DESCRIPTION	TIPO TYPE
5101127	INSERTO BICCHIERI PER CESTO 5101125 500X500mm – GLASSES INSERT FOR BASKET 5101125 500X500mm	A

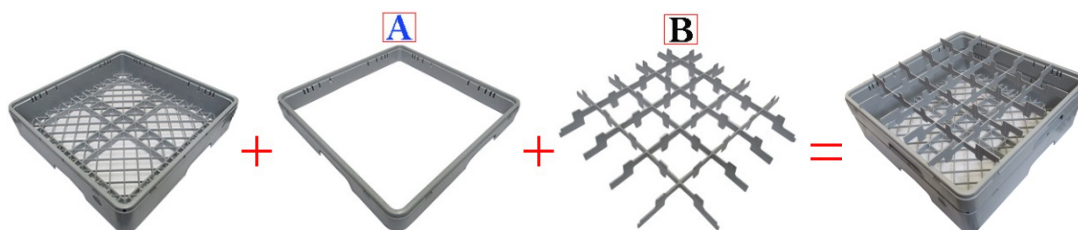

5101083

CODICE S&P S&P CODE	DESCRIZIONE DESCRIPTION	TIPO TYPE	CODICE S&P S&P CODE	DESCRIZIONE DESCRIPTION	TIPO TYPE
5101089	RIALZO H=50mm PER CESTO 5101083 500X500mm - RING H=50mm FOR BASKET 5101083 500X500mm	A	5101087	GRIGLIA 36 BICCHIERI - GRILL 36 GLASSES	B
5101085	GRIGLIA 16 BICCHIERI - GRILL 16 GLASSES	B	5101088	GRIGLIA 49 BICCHIERI - GRILL 49 GLASSES	B
5101086	GRIGLIA 25 BICCHIERI - GRILL 25 GLASSES	B	5101090	GRIGLIA 9 BICCHIERI - GRILL 9 GLASSES	B

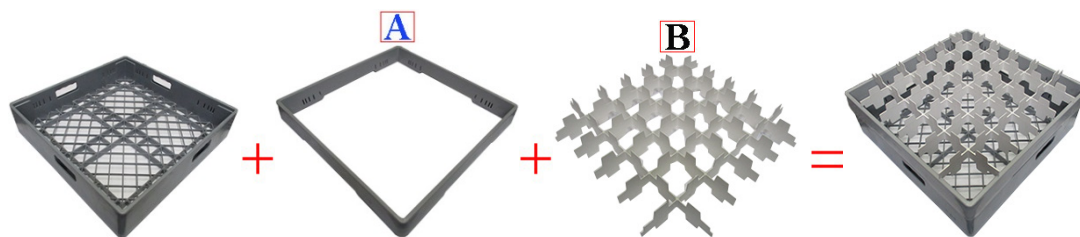

5101104

CODICE S&P S&P CODE	DESCRIZIONE DESCRIPTION	TIPO TYPE	CODICE S&P S&P CODE	DESCRIZIONE DESCRIPTION	TIPO TYPE
5101109	RIALZO H=50mm PER CESTO 5101104 500X500mm- RING H=50mm FOR BASKET 5101104 500X500mm	A	5101111	GRIGLIA 16 BICCHIERI - GRILL 16 GLASSES	B
5101110	GRIGLIA 25 BICCHIERI - GRILL 25 GLASSES	B	5101112	GRIGLIA 36 BICCHIERI - GRILL 36 GLASSES	B

SISTEMA COMPONIBILE / SECTIONAL SYSTEM

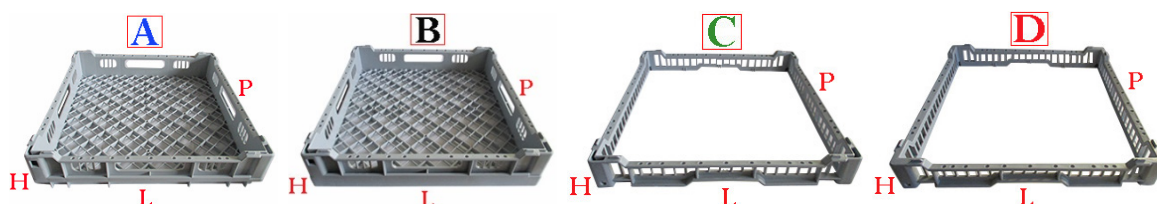



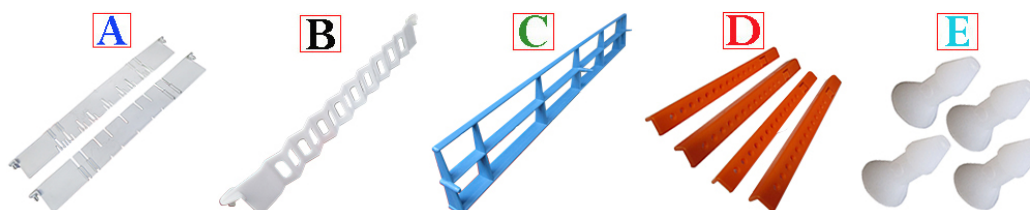







CODICE S&P S&P CODE	DIMENSIONI DIMENSIONS	TIPO TYPE	CODICE S&P S&P CODE	DIMENSIONI DIMENSIONS	TIPO TYPE
5101060	L=390mm P=390mm H=80mm	A SISTEMA COMPONIBILE - SECTIONAL SYSTEM	5101066	400X400mm/ 390X390mm	C ANELLO INTERMENDIO - CENTRAL RING
5101061	L=400mm P=400mm H=80mm	B SISTEMA COMPONIBILE - SECTIONAL SYSTEM	5101072	400X400mm/ 390X390mm	D ANELLO FINALE - FINAL RING





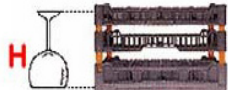
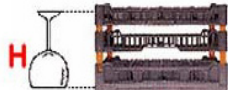

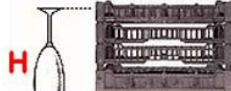
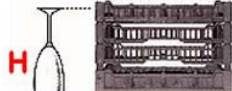









CODICE S&P S&P CODE	DESCRIZIONE DESCRIPTION	TIPO TYPE	CODICE S&P S&P CODE	DESCRIZIONE DESCRIPTION	TIPO TYPE
5101062	COPPIA DIVISORI PARTITIONS PAIR	A	5101065	SET 4 PEZZI ANGOLARI - 4 PIECES KIT ANGULARS	D
5101063	DIVISORE ZIGRINATO KNURLED PARTITION	B	5101067	SET 4 PEZZI RIVETTI - 4 PIECES KIT RIVETS	E
5101064	DIVISORE INCLINATO INCLINED PARTITION	C			

CESTO - BASKET 390 X 390

	9 SPAZI/9 PIECES	16 SPAZI/16 PIECES	25 SPAZI/25 PIECES
<p>*SPECIFICARE ALTEZZA BICCHIERE (H)</p> <p>*INDICATE GLASS HEIGHT (H)</p> <p>*INDIQUER HAUTEUR VERRE (H)</p> <p>*INDICAR ALTURA VASO (H)</p> <p>*GLASHÖHE ANGEBEN (H)</p>	 <p>3x3 112x112 mm - ∅ 111 mm</p>	 <p>4x4 82x82 mm - ∅ 81 mm</p>	 <p>5x5 63x63 mm - ∅ 62 mm</p>
<p>TYPE A *H 0-65 mm</p>  <p>∅</p>	<p>cod. 5101040</p>  <p>∅ max = 111 mm *H max = 65 mm</p>	<p>cod. 5101048</p>  <p>∅ max = 81 mm *H max = 65 mm</p>	<p>cod. 5101056</p>  <p>∅ max = 62 mm *H max = 65 mm</p>
<p>TYPE B *H 80-160 mm</p>  <p>∅</p>	<p>cod. 5101041</p>  <p>∅ max = 111 mm *H max = 160 mm</p>	<p>cod. 5101049</p>  <p>∅ max = 81 mm *H max = 160 mm</p>	<p>cod. 5101057</p>  <p>∅ max = 62 mm *H max = 160 mm</p>
<p>TYPE C *H 180-220 mm</p>  <p>∅</p>	<p>cod. 5101042</p>  <p>∅ max = 111 mm *H max = 220 mm</p>	<p>cod. 5101050</p>  <p>∅ max = 81 mm *H max = 220 mm</p>	<p>cod. 5101058</p>  <p>∅ max = 62 mm *H max = 220 mm</p>
<p>TYPE D *H 240-260 mm</p>  <p>∅</p>	<p>cod. 5101043</p>  <p>∅ max = 111 mm *H max = 260 mm</p>	<p>cod. 5101051</p>  <p>∅ max = 81 mm *H max = 260 mm</p>	<p>cod. 5101059</p>  <p>∅ max = 62 mm *H max = 260 mm</p>

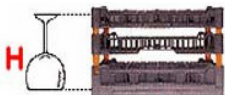
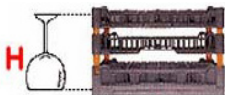
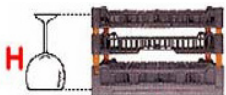
CESTO - BASKET 400 X 400

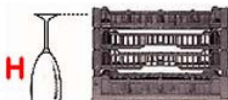
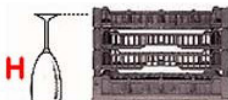
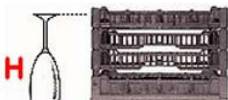
<p>*SPECIFICARE ALTEZZA BICCHIERE (*H) *INDICATE GLASS HEIGHT (*H) *INDIQUER HAUTEUR VERRE (*H) *INDICAR ALTURA VASO (*H) *GLASHÖHE ANGEBEN *(H)</p>	<p>9 SPAZI/9 PIECES</p>  <p>3x3 112x112 mm - ■ Ø 111 mm</p>	<p>16 SPAZI/16 PIECES</p>  <p>4x4 82x82 mm - ■ Ø 81 mm</p>	<p>25 SPAZI/25 PIECES</p>  <p>5x5 63x63 mm - ■ Ø 62 mm</p>
<p>TYPE A *H 0-65 mm</p>  <p>•Ø</p>	<p>cod. 5101036</p>  <p>•Ø max = 111 mm *H max = 65 mm</p>	<p>cod. 5101044</p>  <p>•Ø max = 81 mm *H max = 65 mm</p>	<p>cod. 5101052</p>  <p>•Ø max = 62 mm *H max = 65 mm</p>
<p>TYPE B *H 80-160 mm</p>  <p>•Ø</p>	<p>cod. 5101037</p>  <p>•Ø max = 111 mm *H max = 160 mm</p>	<p>cod. 5101045</p>  <p>•Ø max = 81 mm *H max = 160 mm</p>	<p>cod. 5101053</p>  <p>•Ø max = 62 mm *H max = 160 mm</p>
<p>TYPE C *H 180-220 mm</p>  <p>•Ø</p>	<p>cod. 5101038</p>  <p>•Ø max = 111 mm *H max = 220 mm</p>	<p>cod. 5101046</p>  <p>•Ø max = 81 mm *H max = 220 mm</p>	<p>cod. 5101054</p>  <p>•Ø max = 62 mm *H max = 220 mm</p>
<p>TYPE D *H 240-260 mm</p>  <p>•Ø</p>	<p>cod. 5101039</p>  <p>•Ø max = 111 mm *H max = 260 mm</p>	<p>cod. 5101047</p>  <p>•Ø max = 81 mm *H max = 260 mm</p>	<p>cod. 5101055</p>  <p>•Ø max = 62 mm *H max = 260 mm</p>

CESTO - BASKET 500 X 500

<p>*SPECIFICARE ALTEZZA BICCHIERE (*H) *INDICATE GLASS HEIGHT (*H) *INDIQUER HAUTEUR VERRE (*H) *INDICAR ALTURA VASO (*H) *GLASHÖHE ANGEBEN (*H)</p>	<p>16 SPAZI/16 PIECES  4x4 113x113 mm - $\square\phi$ 112 mm</p>	<p>25 SPAZI/25 PIECES  5x5 88x88 mm - $\square\phi$ 87 mm</p>	<p>36 SPAZI/36 PIECES  6x6 73x73 mm - $\square\phi$ 72 mm</p>	<p>49 SPAZI/49 PIECES  7x7 63x63 mm - $\square\phi$ 62 mm</p>
<p>TYPE A *H 0-75 mm  $\square\phi$</p>	<p>cod. 5101019  $\square\phi$ max = 112 mm *H max = 75 mm</p>	<p>cod. 5101023  $\square\phi$ max = 87 mm *H max = 75 mm</p>	<p>cod. 5101027  $\square\phi$ max = 72 mm *H max = 75 mm</p>	<p>cod. 5101032  $\square\phi$ max = 62 mm *H max = 75 mm</p>
<p>TYPE B *H 100-130 mm  $\square\phi$</p>	<p>cod. 5101020  $\square\phi$ max = 112 mm *H max = 130 mm</p>	<p>cod. 5101024  $\square\phi$ max = 87 mm *H max = 130 mm</p>	<p>cod. 5101028  $\square\phi$ max = 72 mm *H max = 130 mm</p>	<p>cod. 5101033  $\square\phi$ max = 62 mm *H max = 130 mm</p>
<p>TYPE C *H 140-180 mm  $\square\phi$</p>	<p>cod. 5101021  $\square\phi$ max = 112 mm *H max = 180 mm</p>	<p>cod. 5101025  $\square\phi$ max = 87 mm *H max = 180 mm</p>	<p>cod. 5101029  $\square\phi$ max = 72 mm *H max = 180 mm</p>	<p>cod. 5101034  $\square\phi$ max = 62 mm *H max = 180 mm</p>
<p>TYPE D *H 190-240 mm  $\square\phi$</p>	<p>cod. 5101022  $\square\phi$ max = 112 mm *H max = 240 mm</p>	<p>cod. 5101026  $\square\phi$ max = 87 mm *H max = 240 mm</p>	<p>cod. 5101030  $\square\phi$ max = 72 mm *H max = 240 mm</p>	<p>cod. 5101035  $\square\phi$ max = 62 mm *H max = 240 mm</p>

5102031 CESTO PER BICCHIERI D. 340 / GLASSES BASKET D. 340

CEB006: FABAR SRL

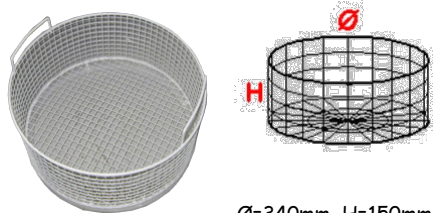

Ø=340mm, H=150mm

5102070 CESTO 348X170 MAGLIA LARGA SENZA ANELLO / BASKET 348X170

706095*:

ELETTROBAR
DIVISIONE DELLA
EUROTEC SRL

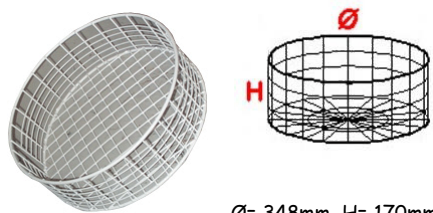

Ø= 348mm, H= 170mm

5102056 CESTO BICCHIERI ROTONDO DIAM.35X11H / GLASSES BASKET 35X11H

706095:

ELETTROBAR
DIVISIONE DELLA
EUROTEC SRL

DWC21:

DIHR-ALI SPA

*: MBM- EUROTEC
SRL - DIV. COOKING
SERVICE

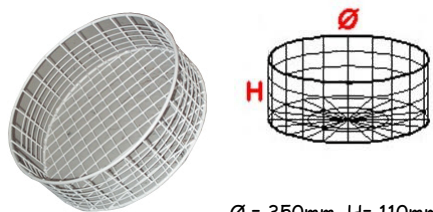

Ø = 350mm, H= 110mm

5102009 CESTO RETE 36X17 BICCHIERI / GLASSES NET BASKET 36X17

984372000:

GRUPPO CIMBALI
SPA

207035:

KRUPPS S.R.L.

69000170:

RANCILIO SPA

15412:

HOONVED - ALI SPA

9090007:

GRUPPO CIMBALI

SPA

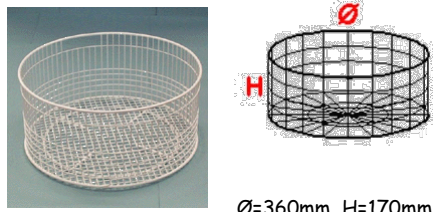

Ø=360mm, H=170mm

5102014 CESTO A RETE 36X23 M.S. / NET BASKET 36X23 NARROW MESH

69000171:

RANCILIO SPA

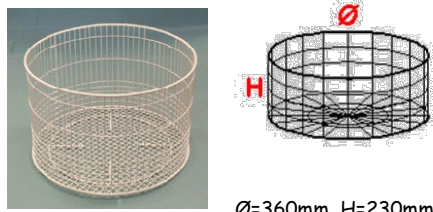

Ø=360mm, H=230mm

5102069 CESTELLO 37X14 / BASKET 37X14

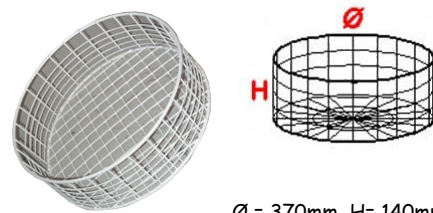

Ø = 370mm, H= 140mm

5102068 CESTO PER BICCHIERI D.390 H130 / BASKET FOR GLASSES D. 390 H130

CEB011: FABAR SRL

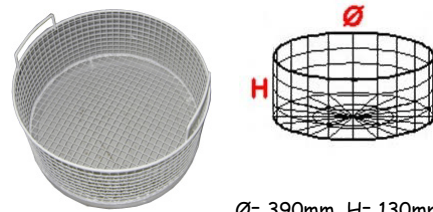

Ø= 390mm, H= 130mm

5102054 CESTO BICCHIERI ROTONDO DIAM.40X14 / GLASSES BASKET 40X14

DWC16:

DIHR-ALI SPA

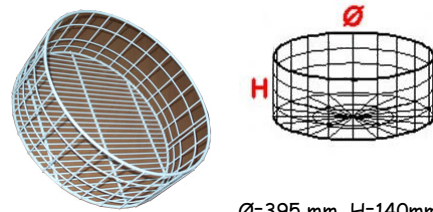

Ø=395 mm, H=140mm

5102005 CESTO RETE 41X17 / NET BASKET 41X17

984296000:

GRUPPO CIMBALI
SPA

69000175:

RANCILIO SPA

15414:

HOONVED - ALI SPA

9190001:

GRUPPO CIMBALI

SPA

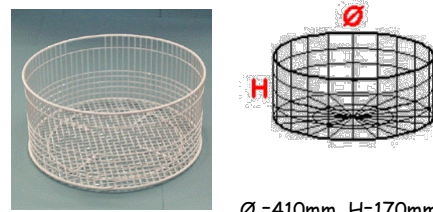

Ø =410mm, H=170mm

5102021 CESTO 41X23 M.S. / BASKET 41X23 NARROW MESH

69000168:

RANCILIO SPA

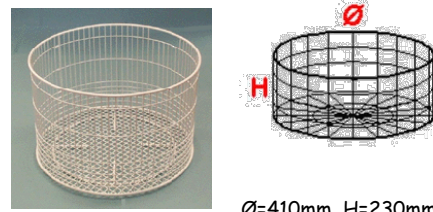

Ø=410mm, H=230mm

5102004 CESTO BICCHIERI D450 CIMSA / BASKET FOR GLASSES D450 CIMSA

CEB021: FABAR SRL

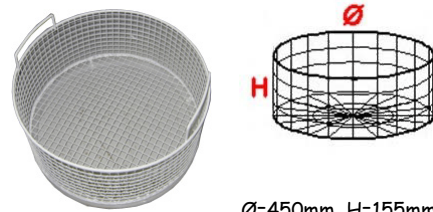

Ø=450mm, H=155mm

5102029 CESTELLO
RETE 45X17 /
NET BASKET 45X17
Z100M003:
S.V. ITALIA SRL
69000172:
RANCILIO SPA
2282000: LASA SRL
15417:
HOONVED - ALI SPA

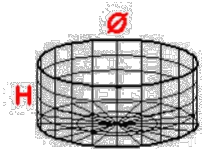

Ø=450mm, H=170mm

5102044 CESTO
BICCHIERI 48X16 /
GLASSES BASKET
48X17

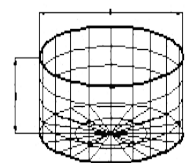

Ø = 480 mm, H =160mm

5102045 CESTO
BICCHIERI D.535 /
BASKET FOR
GLASSES D. 535
CEB049: FABAR SRL

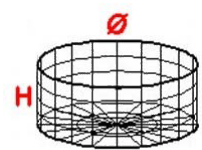

Ø=535mm, H=140mm

5102019 CESTELLO
9 POSIZIONI D. 41X12 /
BASKET 41X12 9
DISHES
69000187:
RANCILIO SPA

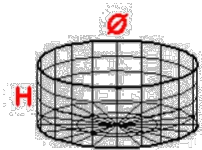

9pcs,
Ø=410mm, H=120mm

5102003 CESTO A
RAGGERA D450
CIMSA /
BASKET D450 CIMSA
CER021: FABAR SRL

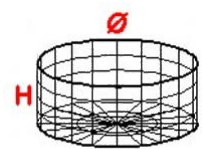

Ø=450mm, H=150mm

5102046 CESTO A
RAGGERA D.535 /
BASKET D. 535
CER049: FABAR SRL

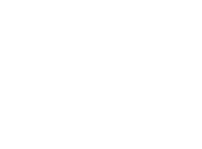

5102048 CESTO
35X35X12 MAGLIA
STRETTA /
BASKET 35X35X12
30087: ADLER S.P.A.
3510: LUXIA SRL

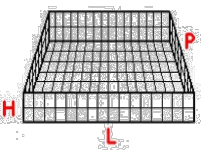

L=350mm, P =350mm, H=
120 mm

5102013 CESTO
RETE 350X350X170
BICCHIERI /
GLASSES NET
BASKET 350X350
69000192:
RANCILIO SPA
15420:
HOONVED - ALI SPA

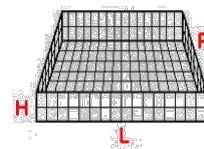

L=350mm, P=350mm,
H=180mm

5102028 CESTO
BICCHIERI
INCLINATO 4 FILE
35X35 /
INCLINED GLASSES
BASKET 35X35

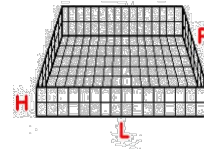

L=350mm, P=350mm,
H=170 mm

5102049 CESTO
BICCHIERI
370X370X135 ML /
GLASSES BASKET
370X370X135
C10: DIHR-ALI SPA

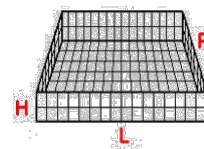

L=370mm, P=370mm,
H=135 mm

5102051 CESTO
38X38X17H MAGLIA
STRETTA /
BASKET 38X38X17H

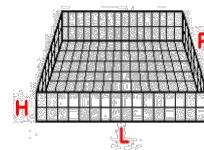
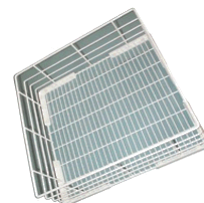

L=380mm, P=380 mm,
H=170mm

5102058 CESTO PER
11/F H.90MM /
BASKET 11/F H.90MM
983055:
ELETTROBAR
DIVISIONE DELLA
EUROTEC SRL

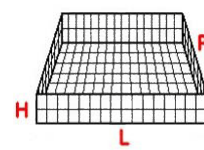
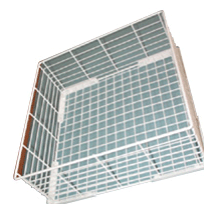

L=385mm, P=385mm,
H=90mm

5102012 CESTO
RETE 40X40x17 /
NET BASKET 40X40
NARROW MESH
69000193:
RANCILIO SPA
44000270:
GRUPPO CIMBALI
SPA

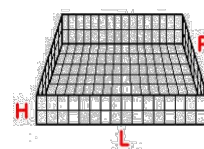

L=400mm, P=400mm,
H=170mm

5102043 CESTO400X
400 INCLINATO 4 FILE
/ INCLINED BASKET
400X400

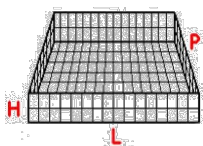

L=400mm, P=400mm,
H=170 mm

5102053 CESTO
40X40 PIATTI 8
POSIZIONI /
DISHES BASKET 8PS
40X40

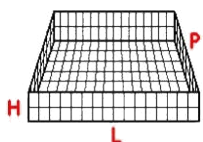
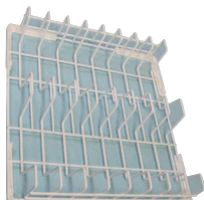

L=400mm, P=400mm,
H=85mm, 8 pcs

5102063 CESTO
BICCHIERI BIANCO
450X450X140MM /
WHITE GLASSES
BASKET
450X450X140MM
983068:
ELETTRORAR
DIVISIONE DELLA
EUROTEC SRL

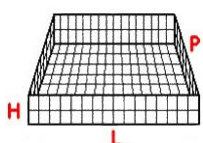

L=450mm, P=450mm,
H=140mm

5102023 CESTO
RETE 45X45X17 /
NET BASKET 45X45
69000194:
RANCILIO SPA
901390:
SILANOS SRL

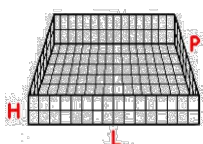

L=450mm, P=450mm,
H=170mm

5102024 CESTO
PIATTI 450X450 14
PIATTI /
BASKET 450X450 14
DISHES
901600:
SILANOS SRL
69000198:
RANCILIO SPA

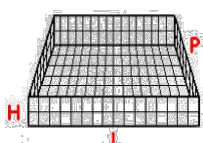
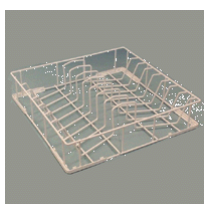

L=450mm, P=450mm, H=
100mm, 14pcs

5102026 CESTELLO
RETE 466X466 SQ55 /
NET BASKET 466X466
SQ55
00206713:
ELFRAMO SPA

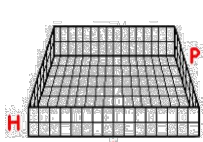

L=466mm, P=466mm

5102006 CESTO
POSATE-BICCHIERI
500X500 MAGLIA
STRETTA /
GLASSES BASKET
500X500 NARROW
MESH

983033:
ELETTRORAR
DIVISIONE DELLA
EUROTEC SRL
983032:
ELETTRORAR
DIVISIONE DELLA
EUROTEC SRL
69000159:
RANCILIO SPA
DWC09:
DIHR-ALI SPA
00007120:
ELFRAMO SPA
C0005:
SISTEMA PROJECT
SERVICE SRL

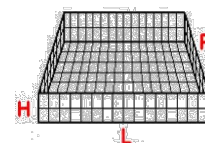

L=500mm, P=500mm,
H=120mm

5102032 CESTELLO
RETE 500X500X170
MAGLIA LARGA /
NET BASKET
500X500X170 LARGE
MESH
69000454:
RANCILIO SPA
2282600: LASA SRL

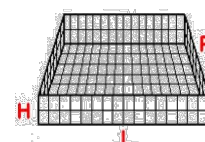

L=500mm, P=500mm,
H=170mm

5102052 CESTO
50X50 INCLINATO 5
FILE /
INCLINED BASKET
50X50

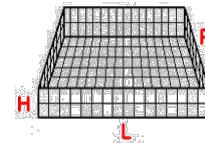

L=500mm, P=500mm,
H=170mm

5102017 CESTELLO
PIATTI 50X50 20 POSTI
/
DISHES BASKET
50X50 20 SPACES
69000453:
RANCILIO SPA

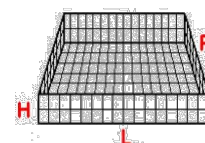

L=500mm, P=500mm,
H=130mm, 20pcs

5102084 CESTO
PIATTI 50X50
SPECIALE 20 POSTI /
BASKET 50X50
SPECIAL 20 DISHES

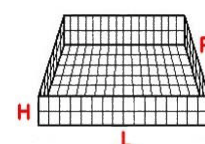
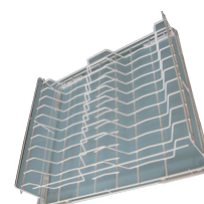

P=500mm, L=500mm,
H=115mm

5102101 Cesto piatti

22 posti 500x500 /
DISHES BASKET
50X50 22 SPACES

3210:

UNIVER-BAR SRL

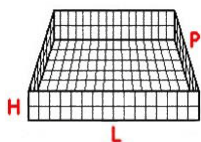
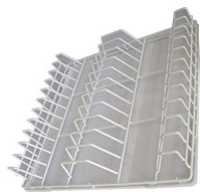

L=500mm, P=500mm,
H=100mm

5102039 CESTO

PIATTI PIZZA 12PS
500X500 /
PIZZA DISHES
BASKET 12PS 500X500

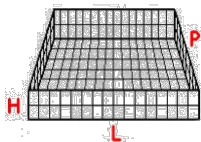
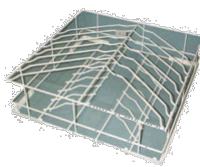

L=500mm, P=500 mm,
H=125mm

5102011 CESTO

POSATE 550X550 M.S. /
CUTLERY-RACK
BASKET 550X550
NARROW MESH

69000157:

RANCILIO SPA

00007140:

ELFRAMO SPA

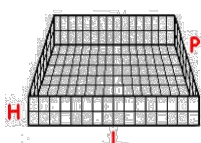

P=550mm, L=550mm,
H=130mm

5102002 CESTO

PIATTI 55X55 /
PLATES BASKET
55X55

69000156:

RANCILIO SPA

00007060:

ELFRAMO SPA

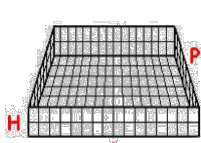
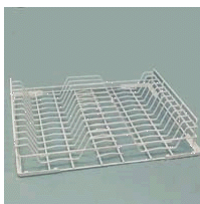

L=550mm, P=550mm

5102034 CESTELLO

PIATTI 16P 600 Q=465 /
BASKET 14 DISHES
600 Q=465

00007000:

ELFRAMO SPA



5102071 CESTO

RETE INOX 50X60 /
STEEL BASKET 50X60

34441:

HOONVED - ALI SPA

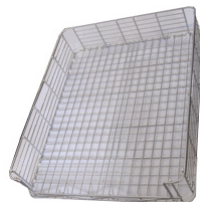

5102080 CESTELLO

G50-60-65L 720X700 /
BASKET G50-60-65L
720X700

530224:

COMENDA ALI SPA



5102095 CESTELLO

INOX G115L-G100L
1320X700X130H /
STEEL BASKET-G115L
G100L 1320X700X130H

530227:

COMENDA ALI SPA

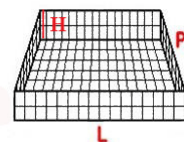
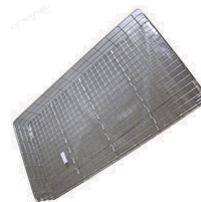

P= 700mm, L= 1320mm,
H= 130 mm

5102085 INSERTO

TEGLIE X C90 LUCE
75MM 484X585MM /
BAKING-PAN INSERT
X CP0 75MM
484X585MM

37549:

HOONVED - ALI SPA

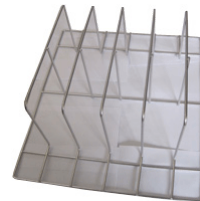

5102100 CESTO

INOX 5 TEGLIE
600x670x250h /
BASKET 5 GRIDS
INSERT 600X670X250H

1159: KRUPPS S.R.L.

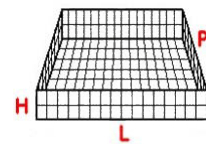
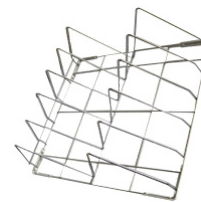

L=600mm, P=670mm, ,
H=250mm

5102041 TELAIO

PORTACESTO 35X35
CESTO TONDO /
BASKET-HOLTER
FRAME 35X35 ROUND
BASKET

207040:

KRUPPS S.R.L.

9191335:

GRUPPO CIMBALI
SPA

984355000:

GRUPPO CIMBALI
SPA

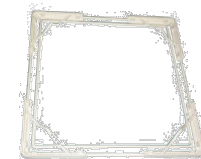

5102083 TELAIO

PORTACESTO 375X375
/
FRAME BASKET
375X375



5102042 TELAIO

PORTACESTO 40X40
CESTO TONDO /
BASKET-HOLTER
FRAME 40X40 ROUND
BASKET

9191340:

GRUPPO CIMBALI
SPA

984356000:

GRUPPO CIMBALI
SPA

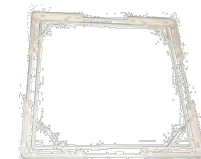

5102065 TELAIO
PORTACESTO ATA
40X40 /
BASKET-HOLDER
FRAME ATA 40X40
7228: A.T.A. SRL



5102073 GRIGLIA
CESTO TONDO D.40 /
GRILL FOR ROUND
BASKET D.40
65433023:
RANCILIO SPA
433023:
ELETTROBAR
DIVISIONE DELLA
EUROTEC SRL

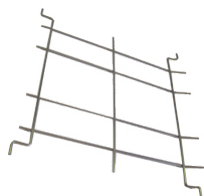

5102096 SUPPORTO
CESTO /
SUPPORT BASKET
1200570:
KRUPPS S.R.L.



5102062 TELAIO
SUPP. CESTELLO IN
FILO MOD. 6 COMP /
BASKET-HOLDER
FRAME MOD. 6 COMP
6M6C6401FC:
OMNIWASH SRL -
SOCIETA' A SOCIO
UNICO



5102015 INSERTO
PORTAPIATTINI 15
POSTI /
RACK FOR SMALL
PLATES 15 SPACES
69000181:
RANCILIO SPA

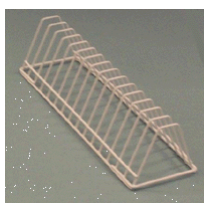

L=310mm, 15pcs

5102016 INSERTO
PORTAPIATTINI 17
POSTI /
RACK FOR SMALL
PLATES 17 SPACES
69000185:
RANCILIO SPA

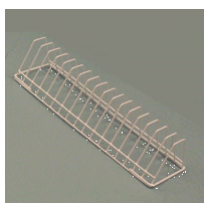

L=350mm, 17pcs

5102094 INSERTO
PORTAPIATTINI 20
POSIZIONI /
INSERT saucer holder 20
POSITIONS



L=405mm, 20pcs

5102064 ANGOLARE
C/ANGOLO TONDO X
CEST /
ROUND ANGULAR
FOR BASKET
27047:
HOONVED - ALI SPA



3105034 PIEDINO
CESTELLO GRIGIO /
BASKET FOOT GREY
461003:
ELETTROBAR
DIVISIONE DELLA
EUROTEC SRL



5102082 GUIDA
CESTELLO C/STS 48 -2
SER /
BASKET GUIDE C/STS
48 -2 SER
322644:
COMENDA ALI SPA
H322644:
HOONVED - ALI SPA



5102103 GUIDA
CESTELLO DX ST/AP
60E /
BASKET GUIDE DX
ST/AP 60E
37342:
HOONVED - ALI SPA



6101007 ADDOLCIT
ORE MACCHINE
FAMIGLIA /
FAMILY MACHINE
WATER-SOFTNER
69000140:
RANCILIO SPA



6101063 ADDOLCIT
ORE FAMIGLIA
RESINE MACCHINE
FAMIGLIA GRC /
FAMILY MACHINE
WATER-SOFTNER
GRMC



Ø=6mm, L=95mm

6101069 ADDOLCIT
ORE FAMIGLIA
RESINE ALTO /
FAMILY MACHINE
WATER-SOFTNER



Ø=6mm, L=135mm

6101088 FILTRO
ADDOLCITORE
ACQUA /
WATER-SOFTNER
2260002000:
UGOLINI SPA



Ø=35X63mm,
Øportagomma=6mm

6101014 ADDOLCIT
ORE 2 COLONNE /
2 COLUMNS WATER-
SOFTNER
640212:
COMENDA ALI SPA
38123250:
RANCILIO SPA



6101072 ADDOLCIT
ORE 3 COLONNE /
3 COLUMNS WATER-
SOFTNER
33590:
HOONVED - ALI SPA



6101009 ADDOLCIT
ORE 4 COLONNE /
4 COLUMNS WATER-
SOFTNER
117004:
ELETTROBAR
DIVISIONE DELLA
EUROTEC SRL
640209:
COMENDA ALI SPA
7641: A.T.A. SRL
171001:

ELETTROBAR
DIVISIONE DELLA
EUROTEC SRL
Z100P015:
S.V. ITALIA SRL
CERI47:

OMNIWASH SRL -
SOCIETA' A SOCIO
UNICO
902150:

SILANOS SRL
38123005:

RANCILIO SPA
DWD98: COLGED
10444: ADLER S.P.A.
9110002:

GRUPPO CIMBALI
SPA

9120002:

GRUPPO CIMBALI
SPA

977094000:

GRUPPO CIMBALI
SPA

1148:

ARISTARCO KASTEL
SPA

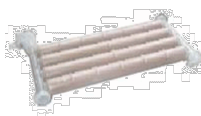

6101112 ADDOLCIT
ORE 4 COLON.
ENTR.CENT /
4 COLUMNS WATER-
SOFTNER - CENTRAL
ENTRANCE
H640216:
HOONVED - ALI SPA



6101086 ADDOLCIT
ORE AUTOMATICO
CABINATO MINICAB
5LT 713 F79B A
VOLUME /
AUTOMATIC
VOLUMETRIC WATER
SOFTENER - CABINET
minicab 5 LT 713 F79B



P=425mm, H=465mm,
H aperto=560mm,
L=240mm,
KIT=6101087,
A=6101105, B=6101106,
C=6101107, D=6101102

6101089 ADDOLCIT
ORE AUTOMATICO
CABINATO
VOLUMETRICO LT12
F79BS /
VOLUMETRIC WATER
SOFTENER - CABINET
LT 12 F79BS



P=530mm, H=600mm,
H aperto=700mm,
KIT=6101087,
L=330mm,
A=6101105, B=6101106,
C=6101107, D=6101102

6101105 VALVOLA
RUNXIN F79B
VOLUME 3/4"UF/DF
PISTONE WBP CON
ACCESSORI (preset
5litri) /
VOLUMETRIC VALVE
RUNXIN F79B
3/4"UF/DF PISTON
WBP WITH
ACCESSORIES (preset
5L)



TRASFORMATORE=
6101103

6101103 TRASFORM
ATORE PER VALVOLA
TMF-EU 220/12 DC 1A /
TRANSFORMER FOR
VALVE TMF-EU 220/12
DC 1A



6101102 SCHEDA
ELETTRONICA DI
CONTROLLO PER
VALVOLA F79 /
ELECTRONIC
CONTROL BOARD
FOR F79 VALVE



6101106 SCHEDA
ELETTRONICA
DISPLAY PER
VALVOLA F79 /
DISPLAY P.C. BOARD
FOR F79 VALVE

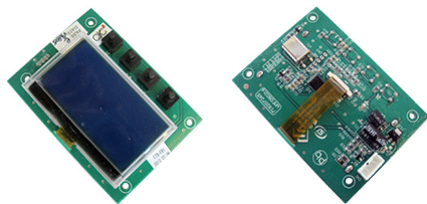

6101107 MOTORINO
PER F63C/F68C /
MOTOR FOR
F63C/F68C



6101087 KIT
DISINFEZIONE DELLE
RESINE PER
VALVOLA RUNXIN /
KIT DISINFECTION
RESINS VALVE Runxin



6101101 COPPIA
RACCORDI 3/4"
CONTATORE PER
VALVOLA F79 /
PAIR METER
JUNCTION 3/4" FOR
F79 VALVE



O-RING=6101099

6101109 KIT O-RING
TANK-PORTAGOMMA
BLFC DADO 3/8 /
KIT O-RING TANK-
RUBBER-HOLDER
BLFC NUT 3/8



G.PIATTA=19X5X3mm,
O-RING
Ø=72,5X5,12mm

6101099 O-RING
RACCORDO 3/4"
CONTATORE PER
VALVOLA F79 /
O-RING METER
JUNCTION 3/4" FOR
F79 VALVE



Ø=19,3X2,62mm,
RACCORDO=6101101

6101104 TURBINA
CONTATORE PER
VALVOLA F79 /
METER FAN FOR F79
VALVE



H=13mm, Ø=23mm

6101036 ADDOLCIT
ORE 8LT
VOLUMETRICO C/KIT
DISINFEZIONE
RESINE /
VOLUMETRIC
WATER-SOFTNER 8LT

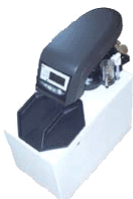

KIT
TESTATA=6101018,
KIT
MEMBRANE=6101019,
TIMER=1112314

6101035 ADDOLCIT
ORE 8LT LOGIX
CABINATO 255/740 /
AUTOMATIC WATER-
SOFTNER 6L LOGIX



L=230mm, P=440 mm,
H=540 mm,
TIMER=1112314,
KIT
TESTATA=6101018,
KIT
MEMBRANE=6101019

6101037 ADDOLCIT
ORE 12LT
VOLUMETRICO C/KIT
DISINFEZIONE
RESINE /
VOLUMETRIC
WATER-SOFTNER
12LT



6101049 ADDOLCIT
ORE 12LT LOGIX
CABINATO 255/740 /
VOLUMETRIC
WATER-SOFTNER
12LT



6101018 KIT
TESTATA
ADDOLCITORE
6+1FIL. /
WATER-SOFTNER
HEAD KIT 6 +1 FIL.



6101035, 6101061,
6101010, 6101011,
6101036

6101019 KIT
MEMBRANE PER AUT
255 /
MEMBRANE KIT FOR
AUT 255



6101035, 6101061,
6101010, 6101011,
6101036

6101071 AIR CHECK
KIT /
AIR CHECK KIT



6101022 TRASFORM
ATORE 220V 12V PER
AUTOTROL /
TRANSFORMER 220V
12V FOR AUTOTROL



6101065 ADDOLCITORE AUTOMATICO CAB. 5LT ELETTRONICO ELECTRONIC AUTOMATIC WATER SOFTENER 5LT

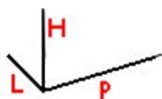

H=420mm, L= 215mm,
P=430mm,
gasket=6101082

6101082 KIT MEMBRANE (VALV. A DISCO PER 604) / MEMBRANES KIT x 6101065



6101081 KIT OR SCARICO E ENTRATA ADDOLCITORE AUTOMATICO / DRAIN AND INLET OR SET FOR AUTOMATIC WATER-SOFTENER



6101025 SACCO RESINA MONOSFERICA LT 25 / MONOSPHERICAL RESIN SACK 25 LT



6101026 BOMBOLA X ADDOLCITORE AUTOMATICO 5LT. / CYLINDER FOR AUTOMATIC WATER SOFTNER 5LT



6101039 DOLCEACQUA ANTICALCARE MICPI IN SCATOLA / DOLCEACQUA



6101054 CARTUCCI A FILTRO PER MACCHINA PER CAFFE' ESO 7 / INSURICE CARTRIDGE FOR COFFEE MACHINE ESO 7

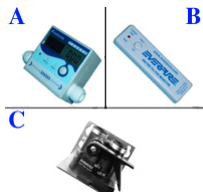

A= 6101051, B=6101052,
C= 6101040,
Capacity=2300 Lt,
H=490mm, Ø=78mm

6101070 CARTUCCI A MC2 / CARTRIDGE MC2

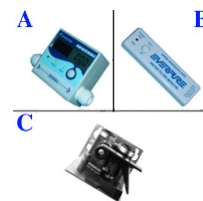

A= 6101051, B=6101052,
C= 6101040, 34000lt,
H=490mm, Ø=78mm

6101066 CARTUCCI A FILTRO MEDIA 4C BEVERAGE / FILTER CARTRIDGE 4C EVERPURE

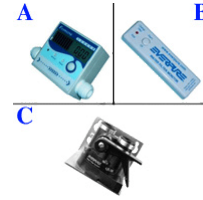

A= 6101051, B=6101052,
C= 6101040,
capacity= 11355lt,
H=337mm, Ø=78mm

6101097 CARTUCCI A PER SCALEKLEEN SANITIZING / CARTRIDGE FOR SANITIZING SCALEKLEEN



TESTATA=6101040,
CONFEZIONE 1KG=1143059

6101077 FILTRO DECARBONATTATORE PER ACQUA +2 RACCORDI 10-3/8" / WATERSOFTNERFILTER + 2 CONNECTIONS 10-3/8"



5 KH= 14000lt,
10 KH=7000lt,
15 KH=4660lt,
20 KH= 3500lt,
25KH= 2800lt,
H=400mm,
Øbase=105mm

6101092 CARTUCCI A CON TESTATA BY PASS CLARIS ULTRA 170 / CARTRIDGE WITH HEAD BYPASS - CLARIS ULTRA 170



Ø=83mm,
H testata=85mm,
H=213mm

6101090 CARTUCCI A CON TESTATA BY PASS CLARIS ULTRA 500 / CARTRIDGE WITH HEAD BYPASS - CLARIS ULTRA 500



Ø=83mm,
H testata=85mm,
H=395mm

6101091 CARTUCCI
A CON TESTATA BY-
PASS CLARIS ULTRA
1000 /
CARTRIDGE WITH
HEAD BYPASS -
CLARIS ULTRA 1000



Ø=130mm,
H testata=85mm,
H=325mm

6101056 TESTATA
CARTUCCIA
BESTMAX XL
WATER+MORE /
CARTRIDGE HEAD
BESTMAX XL
WATER+MORE



H=103mm

6101055 CARTUCCI
A BESTMAX XL
WATER+MORE /
CARTRIDGE
BESTMAX XL
WATER+MORE



= 6101056

6101057 KIT
TESTATA +
CARTUCCIA
BESTMAX XL
WATER+MORE /
CARTRIDGE HEAD +
CARTRIDGE
BESTMAX XL
WATER+MORE



6101079 CARTUCCI
A BESTMAX 2XL /
CARTRIDGE
BESTMAX 2XL



H=460mm, Ø=180mm,
12000 lt, =6101056

6101051 WATER
METER /
WATER METER



6101059 CONTALIT
RI AQUAMETER
WATER+MORE /
WATER METER
WATER+MORE



6101052 FILTER
MONITOR /
FILTER MONITOR



6101073 CONTALIT
RI ACQUA FREDDA
SECCO 3/4" /
COLD WATER METER
3/4"

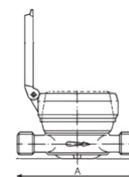

A=130mm

6101083 FILTRINO
DEPURATORE ACQUA
CASADIO /
Small filter CLEANER
WATER CASADIO

998064000:

CASADIO HBS SRL A
SOCIO UNICO



6101084 FILTRO
CASADIO /
FILTER CASADIO

998703000:

CASADIO HBS SRL A
SOCIO UNICO



6101076 ADDOLCIT
ORE A SACCHETTO IN
SCATOLA /
WARTERSOFTNERBA
G IN A BOX



6101080 ADDOLCIT
ORE COMPATTO
0,7LT. /
COMPACT WATER
SOFTNER 0,7LT

640222:

COMENDA ALI SPA



3114011 GIRELLO
LAVABICCHIERI /
DISH WASHER
BASKET HOLDER
SUPPORT

6840: A.T.A. SRL



3112188 GIRELLO
PREMONT. 40 /
BASKET HOLDER
SUPPORT 40

20071:

HOONVED - ALI SPA



3114009 GIRELLO
PREMONTATO 42 /
WALKER PRE 42
20072R:
HOONVED - ALI SPA



Ø=283mm

3114012 PORTACEST
ELLO PICCOLO /
DISH WASHER SMALL
BASKET HOLDER
SUPPORT
25053:
HOONVED - ALI SPA



3114001 GIRELLO
PORTACESTO
LAVATAZZE /
CUP-WASHER BASKET
HOLDER SUPPORT D.
295mm
GG1T1BGR:
OMNIWASH SRL -
SOCIETA' A SOCIO
UNICO
69000153:
RANCILIO SPA



3114017 GIRELLO
MODELLO 1-2
PICCOLO GRIGIO RAL
/
WALKER MODEL 1-2
SMALL GREY RAL
GG1TABGR:
OMNIWASH SRL -
SOCIETA' A SOCIO
UNICO



6116003 DOCCETTA
X LAVASTOVIGLIE /
DISH-WASHER
SHOWER



6116017 DOCCIA
PER CUCINA
INDUSTRIALE A LEVA
/
SHOWER FOR
KITCHEN



6116018 DOCCIA
PER CUCINA
MODELLO DELUXE /
SHOWER FOR
KITCHEN DELUXE



6116031 DOCCETTA
FORNO NERA- GRIGIA
A PULSANTE /
OVEN SHOWER



6116032 DOCCETTA
FORNO NERA ACCIAIO
/
OVEN SHOWER
R62200133:
LAINOX ALI SPA
LAR62200133:
LAINOX ALI SPA



6116043 RUBINETTO
A PEDALE PER SOLO
ACQUA FREDDA /
FOOT OPERATED TAP
COLD WATER ONLY



6116016 MISCELATO
RE A PEDALE /
SHOWER MIXER



6116065 RUBINETTO
MISCELATORE A
PEDALE SOSPESO
TIPO RPR /
MIXER TAP FOOT
PEDAL SUSPENDED
TYPE RPR



6116021 RUBINETTO
MISCELATORE A
PEDALE ECO C/LEVA
BLOC. CROMATO /
SHOWER MIXER COCK



6116042 RUBINETTO
MISCELATORE A
PEDALE RPR CON
DOPPIA LEVA DI
COMAND /
FOOT OPERATED
MIXER TAP WITH TWO
LEVERS CONTROL



6116040 RUBINETTO
MISCELATORE A
PEDALE /
FOOT OPERATED
MIXER TAP



6116041 RUBINETTO
A GINOCCHIO /
KNEE OPERATED TAP



6116051 RUBINETTO
TEMPORIZZATO A
PULSANTE ATTACCO
1/2" /
PUSH-BUTTON
OPERATED TAP WITH
TIME CONTROL 1/2"



6116007 MISCELATO
RE MONOFORO
C/LEVA CLINICA
NERA 1/2" L 250MM /
MONO HOLE MIXER
WITH CLINICAL
LEVER



H Leva aperta= 470mm,
H Leva chiusa= 370mm

6116006 RUB.
BIFORO MONOC. ATT.
DOCCIA DA
1/2"BOCCAF. /
TWO HOLES SINGLE
LEVER MIXER TAP
WITH CAST OUTLET
ATTACHMENT TO
SHOWER UNITS 1/2"



6116025 RUBINETTO
MISCELATORE
BIFORO
MONOCOMANDO
C/LEVA NERA /
2 HOLE MIXER WITH
CLINICAL LEVER



6116054 RUB.
MISCELATORE
BIFORO
MONOCOMANDO A
MURO BOCCAFUSA
DA MM.250 /
TWO HOLES LEVER
MIXER TAP WALL



6116055 RUB.
MISCELATORE
BIFORO MONOC. A
MURO ATT. DOCCIA
BOCCAFUSA /
TWO HOLES LEVER
MIXER TAP WALL



6116059 RUBINETTO
BIFORO
MONOCOMANDO A
MURO LEVA LUNGA
CANNA S M /
WALL-MOUNTED TWO
HOLE TAP ϕ 3/4"



6116009 MONOC.LA
VELLO PERFECTA L.C.
CROMATO /
MONO HOLE MIXER
WITH CLINICAL
LEVER PERFECTA



6116033 MISCELATO
RE MONOFORO
C/DOCCIA ESTRAIBILE
1/2"F /
"MONO HOLE MIXER
WITH EXTRACTABLE
SHOWER 1/2" F"



6116030 MISCELATO
RE 2 VIE ACCIAIO
INOX 304 /
SHOWER MIXER 2
WAY STEINLESS
STEEL 304



6116027 RUBINETTO
MISCELATORE
MONOFORO LEVA
CORTA 3/8" /
"MONO HOLE MIXER
WITH CLINICAL
LEVER 3/8" "



6116047 RUBINETTO
MISC. MONOF.
COMANDI 1/4 DI GIRO
PER ATTACCO GRUPP /
MONOBLOCK MIXER
TAP WITH 1/4 TURN
HANDLE



6116067 RUBINETTO
MISCELATORE
MONOFORO RDF
COMANDI A CROCE
S/CANNA ATT /
MONO HOLE MIXER
RDF



6116046 RUBINETTO
MISCELATORE
BIFORO DA BANCO
CANNA 300MM /
TWO HOLES MIXER
TAP WITH DIAMETER
300mm



6116019 RUBINETTO
MISC.BIFORO DA
BANCO COM 1/4 GIRO
CANNA ATT.1/2"
/ 2 HOLE MIXER HAHN



6116024 MISCELATO
RE MONOFORO
MONOCOMANDO
ATTACCO 3/8" F /
"MONOHOLE MIXER
3/8" F"



6116058 GRUPPO
DOCCIA MIGNON
H.600 COLORE NERO /
MIGNON PRE-
WASHING KIT H600



6116026 GRUPPO
DOCCIA NERO mm1200
/
BLACK MONOHOLE
MIXER WITH SHOWER
1200mm



6116020 GRUPPO
DOCCIA TOP CLASS
COLORE NERO CON
RUBINETTO /
BLACK MONOHOLE
MIXER WITH SHOWER
STAR



6116036 GRUPPO
DOCCIA JOLLY
COMPLETO DI
MISCELATORE /
SHOWER JOLLY WITH
MIXER



6116005 MISCELATO
RE MONOF. NERO
C/DOCCIA CANNA
250MM H DOCCIA
1200MM /
BLUE MONOHOLE
MIXER WITH SHOWER



6116062 GRUPPO
DOCCIA
C/MISCELATORE
MONOFORO LEVA
CLINICA CANNA
250MM DOCCIA
1200MM /
SHOWER WITH MIXER
TAP HOLE - CLINIC
LEVER - BARREL
SHOWER 250MM
1200MM



6116028 EROGATOR
E GIREVOLE CON
CANNA SNODABILE
TIPO JOTA /
SHOWER TYPE JOTA



6116037 CANNA
MISCELATORE
DOCCIONE /
SHOWER MIXER PIPE



6116052 EROGATOR
E SNODABILE
BASETTA CONICA
CANNA U DA MM.250 /
U TYPE ROTATING
SPOUT WITH CONICAL
BASE 250mm



HOLES FOR
FIXING=21mm

6116015 CANNA
ALLUNGABILE 20/40 /
EXTENSIBLE PIPE FOR
WATER TAP 20/40



6116035 CANNA
GIREVOLE
RUBINETTO PER
COLONNINA /
TAP ROTARY PIPE

36100808:
MARENO INDUSTRIE
ALI SPA



6116063 "RUBINETT
O VERTICALE ECO 1/4
DI GIRO CANNA U
MM.200 ATT. DA 1/2" /
"

TAP VERTICAL ECO
1/4 TURN CANE U
mm.200 ATT. 1/2" "



6116039 COLONNIN
A ORIENTABILE H
700MM /
ADJUSTABLE
COLUMN H 700MM



6116050 LEVA
CLINICA MM. 310
COLORE NERO /
BLACK CLINIC LEVER
310mm



6116066 KIT
CARTUCCIA
MISCELATORE + LEVA
/
KIT CARTRIDGE +
LEVER



6116069 CARTUCCIA
CX42 PER RUB.
MONOCOMANDO
ATTACCO 9x9 /
CARTRIDGE CX42 FOR
MIXER 9X9



6116011 CARTUCCIA
RUBINETTO L/CLNC /
CARTRIDGE FOR
COCK L/CLNC

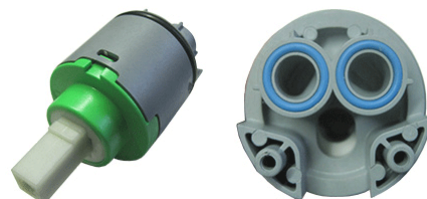

6116045 CARTUCCIA
RIALZATA PER
RUBINETTI
MONOCOMANDO
EURO CON ATTACC /
CARTRIGE



6116022 AERATOR
E M 24 /
STOP JET TAP M 24



6116023 AERATOR
E F 22 /
STOP JET TAP F 22



6116029 RUBINETTO
ACQUA DEPURATA /
PURIFIED WATER
SHOWER
R0223:
EURO TECHNO FLUID
S.R.L



6116049 MOLLONE
DI BILANCIAMENTO
SILVER CON
PROTEZIONE COLORE
NERO /
SILVER SPRING WITH
BLACK PLASTIC
PROTECTION



6116070 "VITONE
1/2" 1/4 DI GIRO
ACQUA FREDDA ATT.
BROCCIA 8x20" /
COLD WATER JOINT
8X20"

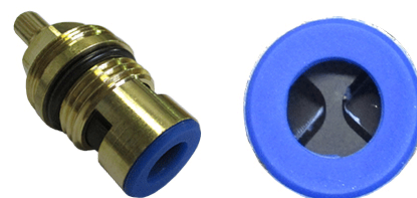

2102041 GUARNIZIO
NE GIGLEUR /
GIGLEUR GASKET

36220008:
RANCILIO SPA
437030:

ELETTROBAR
DIVISIONE DELLA
EUROTEC SRL

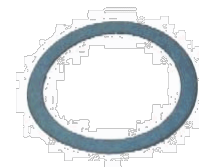

2102068 GUARNIZIO
NE LAVASTOVIGLIE
ZANUSSI /

DISH-WASHER
GASKET ZANUSSI

048236:
ELECTROLUX
PROFESSIONAL
S.P.A.



2102080 GUARNIZIO
NE 14,2X18,5X2 ATA /
GASKET 14,2X18,5X2
ATA
7102: A.T.A. SRL



2102106 GUARNIZIO
NE A LABBRO
45X35,5X7 /
LIP GASKET
45X35,5X7

H200469:
HOONVED - ALI SPA
200469:
COMENDA ALI SPA

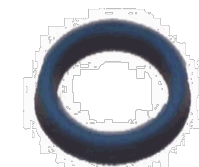

2102107 GUARN.
TUBO CARICO LT 3/4 /
LOAD PIPE GASKET
3/4

2102107:
GRUPPO CIMBALI
SPA

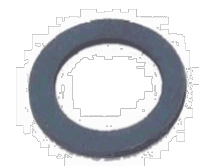

2102110 GUARN.DU
TRAL TRAPPOLA
ARIA PRESSOSTATO /
DUTRAL GASKET F.
AIR TRAP

200467:
COMENDA ALI SPA



2102148 GUARNIZIO
NE CONTENITORE
SALE /
SALT CONTAINER
GASKET

11314: **ADLER S.P.A.**
36201016:
RANCILIO SPA
437034:
ELETTROBAR
DIVISIONE DELLA
EUROTEC SRL
200454:
COMENDA ALI SPA



2102168 GUARNIZIO
NE ASPIRAZIONE 1"3/4
/ "
SUCTION GASKET
1"3/4 "

903320:
SILANOS SRL



2102177 GUARNIZIO
NE TAPPO VALV. AT /
CAP GASKET FOR
VALVE AT

36201005:
RANCILIO SPA



2102181 GUARNIZIO
NE 3/8 TRAPPOLA
ARIA /
GASKET 3/8 FOR AIR
TRAP

9011000:
**GRUPPO CIMBALI
SPA**
903260:
SILANOS SRL



2102189 GUARNIZIO
NE PIANTONE AL /
GASKET 4 HOLES

7138: **A.T.A. SRL**



2102191 GUARNIZIO
NE SOTTOPIANTONE /
GASKET 4 HOLES
740x71x2mm

4391: **A.T.A. SRL**



2102163 GUARNIZIO
NE COND. INFER. S850
/
LOWER DUCT
GASKET. S850

E45, E46, E50, E51,
E52:
ELETTROBAR



2102614 GUARNIZIO
NE GOMMA 105X45X3
4F RIF.167 /
RUBBER SUPPORT
GASKET 105X45X3

0200097:
LAMBER SRL



2102220 GUARNIZIO
NE ESENTE VERDE D.
95X55X2 4 FORI /
GASKET D. 95X55X2 4
HOLES

10160: **FABAR SRL**

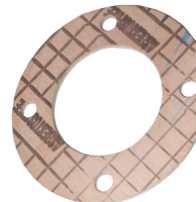

2102307 GUARNIZIO
NE MOZZO
SUPERIORE CQ
84X44,5X2 SUGHERO
M84442F /
HUB GASKET TOP
84X44, 5X2 CORK
M84442F

LS02:
**OMNIWASH SRL -
SOCIETA' A SOCIO
UNICO**



2102272 GUARNIZIO
NE POZZETTO
110X80X3 /
GASKET 110X80X3

905257:
SILANOS SRL



2102356 GUARN.
RACC. LAV.
N45/N50/N700/N1000 /
GASKET
N45/N50/N700/N1000

908141:
SILANOS SRL
3150230: **ANGELO PO**



= 1140145

2102113 GUARN.
CONTROFLANGIA
MOZZO SUP. /
GASKET

903330:
SILANOS SRL



2102285 GUARN.CO
NTROFLANGIA 30X100
C30-C70 /
GASKET
COUNTERFL.C30
30X100X3

200451: **COMENDA**



2102287 GUARNIZIO
NE PER TERMOSTATO
BIMETALLICO /
BIMETALLIC
THERMOSTAT
GASKET

H200494:
HOONVED - ALI SPA
200494:
COMENDA ALI SPA



2102155 GUARNIZIO
NE P/LAMPADA FCV /
GASKET FOR FCV

RTFOC00202:
EUROTEC SRL - DIV.
COOKING SERVICE
MBM



2102375 GUARNIZIO
NE USCITA X R80
(2766-10) /
GASKET X R80 (2766-
10)

28156:
CMA MACCHINE PER
CAFFE' SRL
0146300002:
BRASILIA SPA



2102560 GUARNIZIO
NE 70X70X3 NEOTEN
NE /
SEAL 70x70x3 NEOTEN
NE

200468:
COMENDA ALI SPA

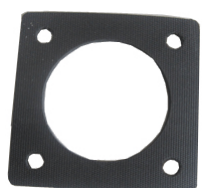

2102463 GUARNIZIO
NE BLOC.RISC.C2001 /
SEAL LOCK RINSE
C2001

H200955:
HOONVED - ALI SPA
200955:
COMENDA ALI SPA



2102429 GUARNIZIO
NE RISC. INF/SUP CR /
GASKET

33784:
HOONVED - ALI SPA



2102471 GUARNIZIO
NE /
GASKET

046360:
ELECTROLUX
PROFESSIONAL
S.P.A.



2102099 GUARNIZIO
NE GOMMA 70X57X3 /
RUBBER GASKET
70X57X3

LS026:
OMNIWASH SRL -



2102392 GUARN.
ESTERNA COLONNA
LAV.N1000/N1300 /
GASKET N1000/N1300

903413:
SILANOS SRL

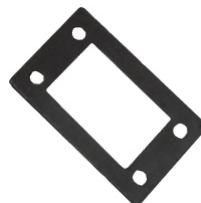

2102363 GUARN. TR.
ARIA
N45/N50/N1000/N130 /
GASKET
N45/N50/N1000/N130

903261:
SILANOS SRL



2102193 GUARNIZIO
NE GOMMA NERA
50X40X2 /
GASKET 50X40X2

984028000:
GRUPPO CIMBALI
SPA



2102194 COLLARE
POMPA GOMMA
MM30 /
SEALING RING MM30

706: ARISTARCO
SPA



2102196 GUARNIZIO
NE CORPO
INFER.E35/40 /
FLAT GASKET
RUBBER E35/40

437079:
ELETTROBAR



2102215 GUARNIZIO
NE RACCORDO
SCARICO LS GOMMA /
DRAIN GASKET LS

36206014:
RANCILIO SPA



2102218 GUARNIZIO
NE ELEMENTO
SENSIBILE 19,5X15X3 /
GASKET FOR
SENSITIVE ELEMENT
19,5X15X3



2102888 GUARNIZIO
NE ESENTE 14,5X6X2
PER DADO 3/8" /
GASKET D.14,5X6X2
FOR NUT 3/8"



2102219 GUARNIZIO
NE ESENTE VERDE D.
16X9X2 -3/8" /
GREEN GASKET
16X9X2



2102214 GUARNIZIO
NE ESENTE D.24X17X2
/
GASKET D. 24X16X2
33372:
HOONVED - ALI SPA



2102400 GUARNIZIO
NE RISCIAQUO
25X12X12 /
RINSE GASKET
25X12X12
0840201420:
MODULAR SPA



2102221 GUARNIZIO
NE MOZZO GIRANTI /
GASKET
903301:
SILANOS SRL



2102222 GUARNIZIO
NE TRAPPOLA
PRESSOTATO C 95-155
/
PRESSURE SWITCH
AIR TRAP GASKET
95-155
H200927:
HOONVED - ALI SPA
C95, C155:
COMENDA ALI SPA



2102228 RONDELLA
X GRANO TIRANTE
FC/LF /
SLIDING WASHER TIE
ROD FC
H160838:
HOONVED - ALI SPA
160838:
COMENDA ALI SPA

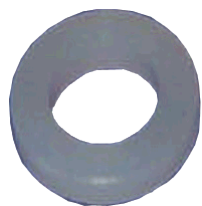

2102545 GUARNIZIO
NE FRY TOP
K9EFR10PP0 /
SEAL FRY TOP
K9EFR10PP0
K00077: A.T.A. SRL



2102229 GUARNIZIO
NE PORTA
LAVAB.LBRLBC /
DOOR GASKET LBR-
LBC
200215:
COMENDA ALI SPA



2102230 GOMMA
SPUGNA 25X4 AUTOD
/
RUBBER GASKET
25X4 AUTOD
200402:
COMENDA ALI SPA



2102250 GUARNIZIO
NE SUPPORTO TARGA
BC-BR-FC /
GASKET PLAQUE
HOLDER BC-BR-FC
200918:
COMENDA ALI SPA



2102256 GUARNIZIO
NE GUIDE "C"tv /
GASKET GUIDE "C" tv
200497:
COMENDA ALI SPA



2102259 GUAR.LAB.
PORTINA "FC/F" /
"DOOR GASKET
"FC/F" "
200901:
COMENDA ALI SPA



fissaggio=4115466

2102260 GUARNIZIO
NE SUPPL.PORTELLO
LAV LINE /
GASKET LAV LINE
200924:
COMENDA ALI SPA



2102261 GOMMA
SPUGNA ADESIVA
6X2,5 EPDM /
RUBBER GASKET
6X2,5 EPDM
200433:
COMENDA ALI SPA



2102604 GUARNIZIO
NE AUTOADESIVA
20X10 /
GASKET Self Adhesive
20x10
36283:
HOONVED - ALI SPA
H36283:
COMENDA ALI SPA



2102232 GUARNIZIO
NE X LABIRINTO
SUPERIORE BHC /
LABYRINTH GASKET
UPPER BHC
200945:
COMENDA ALI SPA



2102379 GUARNIZIO
NE H 2001
AUTOADESIVO SP4 /
GASKET H 2001 SP4
926035:
ELETTROBAR
DIVISIONE DELLA
EUROTEC SRL



2102303 GUARNIZIO
NE PILETTA
ARISTARCO((079) /
DRAIN OUTLET
GASKET ARISTARCO
COMPACT20,
MASTER 21/22,
MINIBAR CF/CR,
GEMINI CF/CR:
ARISTARCO SPA

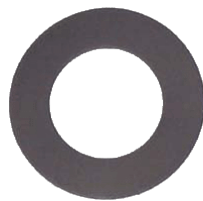

2102605 GUARNIZIO
NE GRUPPO SCARICO
24X3,25 /
GASKET EXHAUST
7605: A.T.A. SRL



24X3,25

2102249 GUARNIZIO
NE DE 156-40/27.3-6.35 /
GASKET DE 156-
40/27.3-6.35
200917:
COMENDA ALI SPA



2102440 GUARNIZIO
NE D22
DOS.BRILL.TECNOPR
O /
GASKET D.22
DW10806:
DIHR-ALI SPA



2102366 GUARN.PRE
LAV.LAV.SHORE 45/50
/
GASKET V
200463:
COMENDA ALI SPA



2102613 GUARN.A
LABBRO DI056
SILICONE 21X13X5mm
/
GASKET SILICONE
21X13X5MM
200977:
COMENDA ALI SPA



21X13X5mm

2102464 GUARNIZIO
NE V /
GASKET V
00530523:
ELFRAMO SPA



2102255 ANELLO DI
TENUTA DE175 EPDM
80SH /
GASKET DE175 EPDM
80SH
06160041:
ELFRAMO SPA



2102498 V-RING D.
14 VA /
V-RING D. 14 VA
PR75508: FABA SRL
75508: CEADO SRL



2102312 GUARNIZ.B
RACCI RISC.SE SE/1 /
GASKET F. RINSE
CONNECT.
H200480:
HOONVED - ALI SPA
200480:
COMENDA ALI SPA



2102342 GUARNIZ.A
LABBRO VITON DE175
/
VITON GASKET DE175
H200950:
HOONVED - ALI SPA
200950:
COMENDA ALI SPA



2102547 ANELLO DI
GOMMA PER
FRULLATORE /
RUBBER RING FOR
BLENDER
DW60567:
DIHR-ALI SPA



2102566 GUARNIZ.T
ENUTA VASCA
SILIC.ROSSO D.160 /
HOLDING TANK
GASKET SILICONE
RED D.160



2102244 GUARNIZIO
NI POMPA 43X27X10 /
PUMP GASKET
43X27X10
DW13306:
DIHR-ALI SPA



2102885 GUARNIZIO
NE RAMP
51X34X14(11/04-
G12/03) /
GASKET FOR WASH
HOSE 51X34X14
DW76081:
DIHR-ALI SPA



2102283 GUARNIZIO
NE CODOLO BOILER /
BOILER GASKET
00010504:
ELFRAMO SPA



2102435 GUARNIZIO
NE GOMMA
MM59X45X2.5 TELATA
/
RUBBER GASKET
MM59X45X2.5
204: ARISTARCO
SPA



2102462 GUARN.
PILETTA TROPPOP.
GOMMA /
RUBBER OVERFLOW
GASKET
K00536:
ARISTARCO SPA

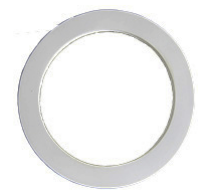

2102616 DISTANZIA
LE PER
MOTORIDUTTORE * /
DISTANCER FOR
GEARMOTOR
10272:
ARISTARCO KASTEL
SPA



2102264 RONDELLA
IN ALGOFIN18x8x1 /
ALGOFIN WASHER
18x8x1
160811:
COMENDA ALI SPA



2102258 GUARNIZIO
NE 60X54 RAMP
C
140 /
GASKET 60X54 RAMP
C140
200482:
COMENDA ALI SPA



2102270 GUARNIZIO
NE 24X16X3
NEOPRENE COM. /
NEOPRENE SEAL
24X16X3
200457:
COMENDA ALI SPA



2102444 GUARNIZIO
NE SCANAL. TAMP.
TRESPADE KG. 7/10 /
GASKET TRESPADE
KG. 7/10



2102450 GUARNIZIO
NE D.110XD.88XSP.3 /
GASKET
D.110XD88XTHICKNES
S 3
200963:
COMENDA ALI SPA



2102237 GUARNIZIO
NE PIANA TORR. T.4
D.57X43X4 /
GASKET D.57X43X4
DW540034:
DIHR-ALI SPA



2102242 GUARNIZIO
NE RAMP
LP2
95X75X3 DIHR /
GASKET 95X75X3
DIHR
DW80208:
DIHR-ALI SPA



2102504 GUARNIZIO
NE GOMMA
BICCH.FRULL. /
RUBBER GASKET FOR
GLASS
DW60183:
DIHR-ALI SPA
C0007F323:
MACAP SRL



2102532 GUARNIZIO
NE PER BICCHIERE /
GASKET FOR GLASS
DW60115:
DIHR-ALI SPA



2102252 GUARNIZIO
NE X GHIERA GRUPPO
DI SCARICO /
SEAL RING NUT FOR
GROUP OF
DISCHARGE

437025:

ELETTROBAR
DIVISIONE DELLA
EUROTEC SRL



2102311 GUARNIZIO
NE GOMMA D42 /
GASKET D. 42

437063:

ELETTROBAR
DIVISIONE DELLA
EUROTEC SRL



2102509 GUARNIZIO
NE RACCORDO
LAVAGGIO
SUPERIORE E.40 /
GASKET FITTING
UPPER WASH E.40

437080:

ELETTROBAR
DIVISIONE DELLA
EUROTEC SRL

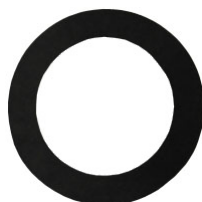

2102531 GUARNIZIO
NE CONDOTTO
INFER.LA50 /
GASKET PIPE LOWER
LA50

437102:

ELETTROBAR
DIVISIONE DELLA
EUROTEC SRL



2102318 GUARNIZIO
NE RESISTENZA HMS /
AIR TRAP GASKET

984272000:

GRUPPO CIMBALI
SPA



2102320 GUARNIZIO
NE GOM.NERA
49X32X1,5* /
GASKET 49X32X1,5*

984191000:

GRUPPO CIMBALI
SPA

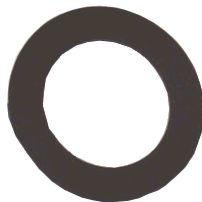

2102321 GUARN.PIL.
SCAR.P 60-80-120 /
DRAIN OUTLET
GASKET P60-80-120

9111105:

GRUPPO CIMBALI
SPA

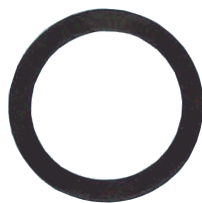

2102316 GUARNIZIO
NE PER PILETTA
ASPIRAZIONE FC /
DRAIN JUNCTION
GASKET FC

H200919:

HOONVED - ALI SPA

200919:

COMENDA ALI SPA

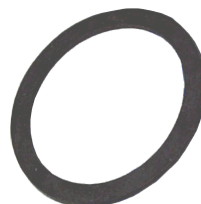

2102899 GUARNIZIO
NE PIATTA SONDA /
PROBE GASKET

34520EX:

HOONVED - ALI SPA

200870:

HOONVED - ALI SPA



DIMENSIONS
18X10X2mm

2102430 GUARNIZIO
NE PIATTA 31 X 21 X 2
/
GASKET FLAT 31 X 21
X 2

25267:

HOONVED - ALI SPA



2102454 GUARNIZIO
NE PIATTA /
GASKET

1131: KRUPPS S.R.L.



2102559 GUARNIZIO
NE ASPIRAZIONE -
MANDATA POMPA
SERIE S sp.2 /
GASKET SUCTION -
FLOW PUMP SERIES S
sp.2

903302:

SILANOS SRL



2102898 GUARN. M
12 TR. ARIA /
AIR TRAP GASKET
M12

903263:

SILANOS SRL



DIMENSIONS
20X12X2mm

2102269 GUARNIZIO
NE
GOM.SCAR.44X32X3
EP /
RUBBER GASKET
44X32X3 EP

19000:

SISTEMA PROJECT
SERVICE SRL



2102583 Guarnizione
Ø 14X8X2mm gabbia
d'aria /
FLAT GASKET ø
14x8x2 mm
2017:
UNIVER-BAR SRL



Ø=14X8X2mm

2102887 Guarnizione
valvola antiriflusso /
Non-return valve seal
4227:
UNIVER-BAR SRL



=24X1,5mm

2102443 GUARNIZIO
NE FILTRO /
FILTER GASKET
3754:
UNIVER-BAR SRL



2102569 ANELLO
CENTRIFUGO /
RING CENTRIFUGAL



2107232 GUARNIZIO
NE TEFLON
8X4X1,5mm /
TEFLON GASKET
8X4X1,5mm



2107147 GUARNIZIO
NE 1"1/4 /
"GASKET 1"1/4"



2102268 GUARNIZIO
NE BRASILIA
142X128X4 /
GASKET BRASILIA
142X128X4

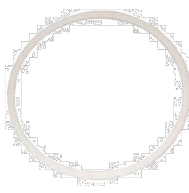

2102273 GUARNIZIO
NE TEFLON 50X36X2 /
TEFLON GASKET
50X36X2



2102274 GUARNIZIO
NE TUBO D. 8 /
GASKET D.8
160805:
COMENDA ALI SPA



2102324 GUARNIZIO
NE NYLON
12,5X5X1,5* /
NYLON GASKET
12,5X5X1,5*
9011015:
GRUPPO CIMBALI
SPA



2102554 GUARNIZIO
NE /
GASKET
007005:
ELECTROLUX
PROFESSIONAL
S.P.A.

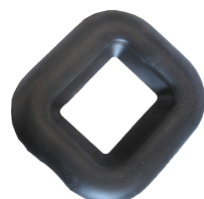

2102347 GUARNIZIO
NE TAPPO CHIUSURA /
CLOSING TAP
GASKET
437082:
ELETTOBAR
DIVISIONE DELLA
EUROTEC SRL



2102305 GUARNIZIO
NE IN GOMMA
RISCIACQUO /
RINSE RUBBER
GASKET
E46, E50, E51, E52:
ELETTOBAR
DIVISIONE DELLA
EUROTEC SRL



2102543 GOMMINO
FIANCHETTO EPOCA /
GASKET
36322004:
RANCILIO SPA



2102538 GUARNIZIO
NE PULSANTIERA
FELSINEA /
KEYBOARD GASKET
FELSINEA



2102897 GUARNIZIO
NE LAMPADA /
LAMP GASKET



DIMENSIONS
93X78X2,5mm

2102567 GUARNIZIONE /
GASKET
099277:
ELECTROLUX
PROFESSIONAL
S.P.A.



2102483 GUARNIZIONE POSTER. SCATOLA TERM. /
BOX GASKET
H200491:
HOONVED - ALI SPA
200491:
COMENDA ALI SPA



2102883 GUARNIZIONE PER CONSOLE COMANDI CON DISPLAY LCD /
GASKET FOR CONSOLE COMMANDS WITH LCD DISPLAY
103779:
KRUPPS S.R.L.

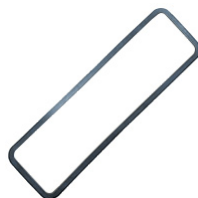

157X42X1,5mm

2102493 GUARNIZIONE COMMA CAPPELLO FC06 /
DOOR GASKET
200219:
COMENDA ALI SPA



2102553 GUARNIZIONE SILICONE PORTA 10X16 Sh50 /
SILICON GASKET DOOR 10x16 Sh50
H36883:
COMENDA ALI SPA
36883:
HOONVED - ALI SPA



2102522 GUARNIZIONE PORTA /
DOOR GASKET
437103:
ELETTRORBAR
DIVISIONE DELLA
EUROTEC SRL



2102555 GUARNIZIONE SILICONE PORTA 13X18 C53E /
SILICON GASKET DOOR 13X18 C53E
36925:
HOONVED - ALI SPA



2102542 GUARNIZIONE N D INTERNO 160 mm
DIAMETRO ESTERNO 200 mm /
SEAL INSIDE
DIAMETER 160 mm
OUTSIDE DIAMETER 200 mm

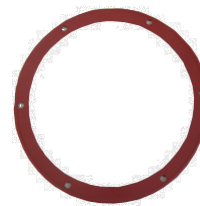

2102545 GUARNIZIONE FRY TOP
K9EFR10PP0 /
SEAL FRY TOP
K9EFR10PP0
K00077: A.T.A. SRL



1117143 MOLLA PORTA /
DOOR SPRING
36H1430:
ANGELO PO GRANDI
CUCINE SPA



1117122 MOLLA PORTA AL 40.28/ALISEO /
DOOR SPRING AL 40.28/ALISEO
3269:
ARISTARCO KASTEL
SPA



1117260 MOLLA PER PORTA SERIE AL /
TENSION SPRING FOR DOOR AL
6377:
ARISTARCO KASTEL
SPA



1117173 MOLLA BILANC. PORTA LF2006/GF70 /
DOOR SPRING LF2006/GF70
LF321:
COMENDA ALI SPA



1117103 MOLLA MANIGLIONE C30/70/75 /
HANDLE SPRING C30/70/75
391312:
COMENDA ALI SPA



1117229 MOLLA
PER PORTA FC4 /
DOOR SPRING FC4

391334:
COMENDA ALI SPA



1117732 MOLLA
BILANC.PORTA+PIAS
TRINE /
DOOR SPRING

450290:
COMENDA ALI SPA
37675:
HOONVED - ALI SPA
H37675:
COMENDA ALI SPA



1117202 MOLLA
PER PORTA FC3 /
DOOR SPRING FC3

391336:
COMENDA ALI SPA



1117075 MOLLA
SOLLEVAMENTO L
CORTA DIHR /
SPRING EDGEWISE

DW10800034:
DIHR-ALI SPA
DW10800033:
DIHR-ALI SPA



1117082 MOLLA
PER PORTA DIS.LS034
DERBY /
SPRING DOOR
DIS.LS034 DERBY

DW10700:
DIHR-ALI SPA



1117154 MOLLA
POSTERIORE S12 /
SPRING S12

DW70302:
DIHR-ALI SPA



1117121 MOLLA
PORTA /
DOOR SPRING

DW560003:
DIHR-ALI SPA



1117206 MOLLA
SPORTELLO 600/05 /
SPRING DOOR 600/05

DW570200:
DIHR-ALI SPA



1117031 MOLLA
PENTOLE 051527 /
POT SPRING 051527

051527:
ELECTROLUX
PROFESSIONAL
S.P.A.



1117134 MOLLA
ACCIAIO A
TRAZIONE PER
LAVASTOVIGLIE /
SPRING STEEL DRIVE
FOR DISHWASHER

926108:
ELETTRORBAR
DIVISIONE DELLA
EUROTEC SRL



1117240 MOLLA
BILANCIAMENTO
PORTA LA50 /
DOOR SPRING LA50

449059ex:
ELETTRORBAR
DIVISIONE DELLA
EUROTEC SRL
449063:
ELETTRORBAR
DIVISIONE DELLA
EUROTEC SRL



1117142 MOLLA
TIRANTE PORTELLO
D40 /
SPRING D40

00013719:
ELFRAMO SPA
D40-D36-D45:
ELFRAMO SPA



1117215 MOLLA
SOLLEVAMENTO C44

/
SPRING C44
00018056:
ELFRAMO SPA



1117305 MOLLA
TELESCOPICA C33
ASSIEME+++++ /
TELESCOPIC SPRING
ASSEMBLY C33

00018522:
ELFRAMO SPA



1117268 MOLLA
ASTA
SOLLEVAMENTO
CF10 /
LIFTING SPRING
9131428:
GRUPPO CIMBALI
SPA



1117132 MOLLA A
TORSIONE DESTRA
NAP /
RIGHT SPRING NAP
986029000:
GRUPPO CIMBALI
SPA
9131553ex:
GRUPPO CIMBALI
SPA



1117133 MOLLA A
TORSIONE SINISTRA
NAP /
LEFT SPRING NAP
9131554:
GRUPPO CIMBALI
SPA
986030000:
GRUPPO CIMBALI
SPA



1117747 SPRING /
SPRING
774591:
HOBART GmbH



1117062 MOLLA X
PORTA C 90 /
DOOR SPRING C 90
34773:
HOONVED - ALI SPA



1117761 MOLLA
PORTA C90E 2007 /
SPRING DOOR C90E
2007
37337:
HOONVED - ALI SPA



1117249 MOLLA
PORTA L=68 DE=13,2
D=1,5 /
SPRING DOOR L = 68
DE = 13.2 D = 1.5
450298:
HOONVED - ALI SPA
36860ex:
HOONVED - ALI SPA



1117221 MOLLA
PORTA L=68 DE=13,2
D=1,4 /
DOOR SPRING L=68
DE=13,2 D=1,4
36625:
HOONVED - ALI SPA



1117189 MOLLA X
PORTA EDI /
DOOR SPRING EDI
34927:
HOONVED - ALI SPA



1117025 MOLLA
MANIGLIONE /
HANDLE SPRING
1033711400:
MARENO
INDUSTRIE ALI
SPA
2385170: LASA SRL



1117242 MOLLA
PORTA PORTINA
H280 MARELS /
DOOR SPRING H280
MARELS
260.017.00:
MODULAR SPA



1117757 MOLLA
CAPPOTTA LS /
SPRING Capote LS
26001900:
MODULAR SPA



1117061 MOLLE A
TRAZIONE CAPPOTTA
FILO A 98 DIAMETRO
5,1 /
COVER SPRINGS
THREAD 98 D. 5,1
GMML6261:
OMNIWASH SRL -
SOCIETA' A SOCIO
UNICO

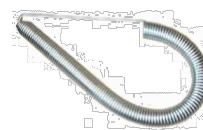

1117022 MOLLA
RICHIAMO LEVA
MD40/50/80 /
LEVER SPRING
MD40/50/80
39220010:
RANCILIO SPA



1117009 MOLLA
RICHIAMO CAPOTTA
1105 /
COVER SPRING 1105
39220100:
RANCILIO SPA
1117009: EURO 2000



1117036 MOLLA
AMMORTIZ. LEVA
FR.NE /
TENSION SPRING
39220025:
RANCILIO SPA



1117100 MOLLA
PORTELLO /
DOOR SPRING
904051:
SILANOS SRL
908041ex:
SILANOS SRL
908043:
SILANOS SRL



1117311 MOLLA
PORTA N45/N50/N90 /
DOOR SPRING
N45/N50/N90
908042:
SILANOS SRL



1117017 MOLLA
SOLLEV. CAPOT 1000-
1300 /
COVER SPRING 1000-
1300
*: SILANOS SRL
904137:
SILANOS SRL
1117017:
S.V. ITALIA SRL



1117272 MOLLA
PORTA
MIX/TOP/BET37/BET4
0 /
SPRING DOOR
MIX/TOP/BET37/BET4
0
4042:
UNIVER-BAR SRL



1117273 MOLLA
CAPOTTA COMPACT /
SPRING COMPACT
4540:
UNIVER-BAR SRL



1117208 SISTEMA
MOLLA PORTA /
SPRING DOOR
SYSTEM
1598:
UNIVER-BAR SRL



1117157 MOLLA
PULSANTE /
PUSH-BUTTON
SPRING
7635: A.T.A. SRL



1117071 MOLLA X
TROPPO PIENO BHC /
OVERFLOW SPRING
BHC
450232:
COMENDA ALI SPA



1117108 MOLLA X
TROPPO PIENO /
overflow spring
450232*:
HOONVED - ALI SPA
30426ex:
HOONVED - ALI SPA



1117072 MOLLA
PERNO PORTA BHC /
PRESSURE SPRING
450234:
COMENDA ALI SPA
450234:
HOONVED - ALI SPA
30438ex:
HOONVED - ALI SPA



1117794 MOLLA
BLOCCHETTO MRS /
SPRING MRS
00001672:
ELFRAMO SPA



1117799 SPRING /
SPRING
437994:
HOBART GmbH



1117787 SPRING-
COMPRESSION /

SPRING-
COMPRESSION
119229:
HOBART GmbH



1117155 MOLLA
INOX MEMBR.
DOSAT. DM.14,5X26 /
SPRING DM.14,5X26
DS4:
OMNIWASH SRL

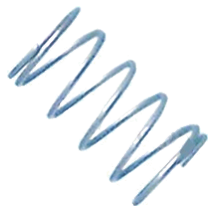

1117156 MOLLA
INOX VAL NON RIT
DOSAT.DM.0,3X6X13
SP.0,7 /
SPRING DM.0,3X6X13
SP.0,7
DSVNR14:
OMNIWASH SRL-



1117741 MOLLA
INOX MICRO
POST.MOD.6S /
STAINLESS STEEL
SPRING MICRO POST.
MOD.6S
CEMMP6S:
OMNIWASH SRL -
SOCIETA' A SOCIO
UNICO



1117049 MOLLA
INOX PER
SICUREZZA PORTA
IME /
STAINLESS STEEL
SPRING FOR DOOR
CEMP20:
OMNIWASH SRL -
SOCIETA' A SOCIO
UNICO



1117308 MOLLA
SCROCCHETTO
1X8,5X11 SPIRE 5 /
WHOLE PAWL
SPRING 1X8,5X11
AM011C:
OMNIWASH SRL -
SOCIETA' A SOCIO
UNICO



1117090 MOLLA AD
ARCHETTO TAPPO
LAVAG. /
SPRING WASH CAP
2654:
ARISTARCO KASTEL
SPA



1117767 MOLLA
LEVERAGGIO PORTA
ST/BC /
LEVER DOOR
SPRING ST / BC
450250:
COMENDA ALI SPA
450250:
HOONVED - ALI SPA



1117734 MOLLA
FERMO PORTA SERIE
ST/E /
DOOR SPRING ST/E
37339:
HOONVED - ALI SPA



1117094 MOLLA
BLOCC.FILTRO
BC/BR /
FILTER SPRING
BC/BR
450223:
COMENDA ALI SPA



1117738 MOLLA
SAGOMATA
APERTURA/CHIUS.PO
RTA LA50 /
DOOR SPRING LA50
449058:
ELETTOBAR
DIVISIONE DELLA
EUROTEC SRL



1117292 MOLLA x
FILTRO ASPIR.(34557)
/
SPRING SUCTION
FILTER (34557)
35870:
HOONVED - ALI SPA



FILTER=3126057

1117300 MOLLA /
SPRING
1415: KRUPPS S.R.L.



1117125 MOLLA
INOX DX PORTA 1A-2
FILO DM. 2,3 MM /
RIGHT STAINLESS
STEEL SPRING FOR
DOOR 1A-2 DM. 2,3
MM
AMMP1A2DX:
OMNIWASH SRL -
SOCIETA' A SOCIO
UNICO



1117126 MOLLA
INOX SX PORTA 1A-2
FILO DM. 2,3 MM /
LEFT STAINLESS
STEEL SPRING FOR
DOOR 1A-2
DM.2,3MM
AMMP1A2SX:
OMNIWASH SRL -
SOCIETA' A SOCIO
UNICO



1117026 MOLLA
INOX DX PORTA
MOD. 1 /
RIGHT STAINLESS
SPRING FOR DOOR
MOD. 1
AMMP1DX:
OMNIWASH SRL -
SOCIETA' A SOCIO
UNICO



1117027 MOLLA SX
PORTA MOD.1 /
LEFT SPRING FOR
DOOR MOD. 1
AMMP1SX:
OMNIWASH SRL -
SOCIETA' A SOCIO
UNICO



1117758 MOLLA
INOX DX PORTA 4
FILO DM. 2,5M /
DOOR SPRING DX 4
STAINLESS STEEL
WIRE DM. 2.5 M
AMMP24DX:
OMNIWASH SRL -
SOCIETA' A SOCIO
UNICO



1117759 MOLLA
INOX SX PORTA 4
FILO DM. 2,5M /
DOOR SPRING SX 4
STAINLESS STEEL
WIRE DM. 2.5 M
AMMP24SX:
OMNIWASH SRL -
SOCIETA' A SOCIO
UNICO



1117069 MOLLA X
UGELLO RISC. 170963
/
RINSING JET SPRING
170963
450236:
COMENDA ALI SPA
34293ex:
HOONVED - ALI SPA
450236:
HOONVED - ALI SPA



1117777 KIT
MOLLA
BILANCIAMENTO
PORTE BSR22 - SERIE
TR /
KIT SPRING
BALANCING DOOR
BSR22 - TR SERIES
9653:
ARISTARCO KASTEL
SPA



1117760 GRUPPO
MOLLA KG 3.0 40mm /
GROUP SPRING
KG(3.0 40mm
391314:
COMENDA ALI SPA

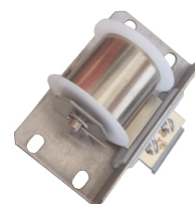

1117093 GRUPPO
MOLLA "KG.3,5"-
MM.40 /
"SPRING KIT
""KG.3,5""-MM.40"
391317:
COMENDA ALI SPA

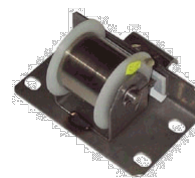

1117123 GRUPPO
MOLLA "KG.5"-MM.40
/
"SPRING GROUP KG.
5""- MM40"
391331:
COMENDA ALI SPA
391331:
HOONVED - ALI SPA



1117052 MOLLA X
LAVASTOVIGLIE
0E5167 /
DISH-WASHER
SPRING 0E5167
0E5167:
ELECTROLUX
PROFESSIONAL
S.P.A.



1117159 "MOLLA A
NASTRO; 25X0,5 MM"
/
ROLLER SPRING
25X0,5 MM"
0E5158:
ELECTROLUX
PROFESSIONAL
S.P.A.

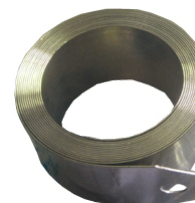

1117162 MOLLA
SR20 /
SPRING SR20
927020:
ELETTRORAR
DIVISIONE DELLA
EUROTEC SRL



1117776 KIT
MOLLE SPORTELLO
GOLD80/RIVER150 /
KIT SPRINGS DOOR
GOLD80 / RIVER150
75271:
ELETTRORAR
DIVISIONE DELLA
EUROTEC SRL



1117745 SCROLL
SPRING /
SCROLL SPRING
378591:
HOBART GmbH



1117288 MOLLA
ES50 /
SPRING ES50
9803030:
KRUPPS S.R.L.



1117255 MOLLA
PORTA
PRELAV/PRER. KG.
3,2 680MM /
DOOR SPRING KG.3,2
680MM
TR1860:
SILANOS SRL

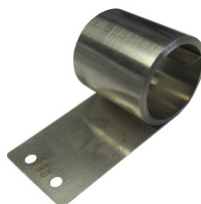

1117060 MOLLE A
GAS LIFT O MAT 230 /
GAS SPRING LIFT O
MAT 230



1117068 MOLLE A
GAS LIFT O MAT SA
226,5 /
GAS SPRING LIFT O
MAT SA 226,5



1117089 MOLLE A
GAS FS
03010816100850500 /
GAS SPRING FS
03010816100850500



1117092 MOLLE A
GAS LIFT O MAT
600N 690430 /
GAS SPRING LIFT O
MAT 600N 690430



1117107 PISTONE
LIFT O MAT 690422 0
500N /
SPRING LIFT O MAT
690422 0 500N



1117149 MOLLA
GAS LIFT-O-MAT
400N 690384 /
GAS SPRING LIFT-O-
MAT 400N 690384



1117195 MOLLA
HYDROLIFT 0300N /
SPRING HYDROLIFT
0300N



1117223 PISTONE
LIFT-O-MAT 278076 /
SPRING LIFT O MAT
278076



1117233 MOLLA A
GAS 082430 /
GAS SPRING 082430



1117234 PISTONE
HIDRO-LIFT 2607GS
0200N /
SPRING HIDRO-LIFT
2607GS 0200N



1117294 MOLLA
LIFT-O-MAT 690N
690449 /
GAS SPRING LIFT O
MAT 690N 690449



1117298 MOLLA
GAS LIFT O MAT
0100N 082570 /
SPRING LIFT GAS OR
MAT 0100N 082 570



1117302 MOLLA A
PISTONE LIFT O MAT
291250 /
GAS SPRING PISTON
LIFT O MAT 291250



1117306 MOLLA A GAS 0308060000-0200 HYDRO LIFT 210N / GAS SPRING 0308060000-0200 HYDRO LIFT 210N



1117307 MOLLA A GAS 0306120000-0300 LIFT O MAT SA 305,5 / GAS SPRING 0306120000-0300 LIFT O MAT SA 305,5



1117766 MOLLA A GAS 0400N FORO 8,2 - 6 + GRANO 90° / GAS SPRING 0400N HOLE 8.2 to 6 + 90° WHEAT



3105009 PIEDINO LAVATAZZE M8 / CUP-WASHERS SUPPORT M8
904980:
SILANOS SRL

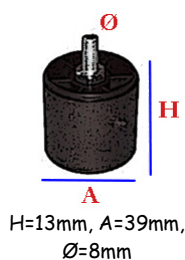

3105054 PIEDINO LAVASTOVIGLIE M10 hmrnsn / FOOT DISHWASHER M10 hmrnsn
984006000:
GRUPPO CIMALI SPA

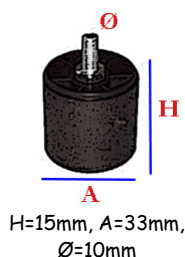

3105001 PIEDINO LT M10 / SUPPORT LT M10
69000230:
RANCLIO SPA

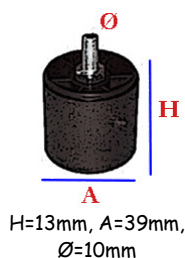

3105030 PIEDINO 30MM M10 / FOOT 30 MM
210203:
COMENDA ALI SPA

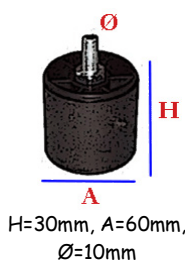

3105022 PIEDINO BASE ESAGONALE HNVD M10 / SUPPORT HOONVED 210210:
HOONVED - ALI SPA
25209ex:
HOONVED - ALI SPA

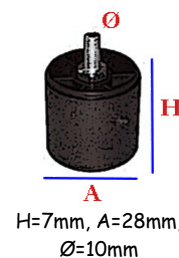

3105037 PIEDINO REGOLABILE D=47 / ADJUSTABLE SUPPORT D=54
00000970:
ELFRAMO SPA

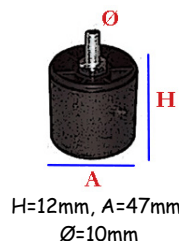

3105015 PIEDINO M10 LAVAPIATTI / FOOT M10
904990:
SILANOS SRL



3105024 PIEDINO REGOLABILE FABA / SUPPORT FABA
ALL MODEL/TUTTI I MODELLI: FABA SRL



3105066 PIEDINI IN GOMMA / RUBBER SUPPORT
EBO19: OBEL SRL

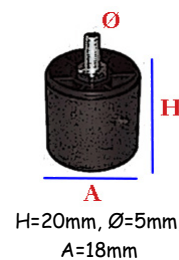

3105026 PIEDINO COMPLETO MAZZER / COMPLETE SUPPORT MAZZER
S00SPIA01QQQ:
MAZZER LUIGI SPA

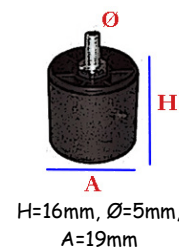

3105045 PIEDINO M6 D.20 H.15mm / LEG DD 2015 H
P000PIA02QQQEX:
MAZZER LUIGI SPA
P000PIA04QQQ:
MAZZER LUIGI SPA



3105008 PIEDINO
Z11 COMPLETO M10 /
COMPLETE SUPPORT
Z11
10090012:
RANCILIO SPA



H=45mm, A=60mm,
Ø=10mm

3105017 PIEDINO
REGOLABILE/RIALZA
BILE UNIVERSALE /
UNIVERSAL
ADJUSTABLE/RAISAB
LE SUPPORT
0300030+0300040:
MAGISTER SISTEMA
CAFFE' SRL
900069:
MAGISTER SISTEMA
CAFFE' SRL



H=57mm, A=58mm,
Ø=10mm

3105032 PIEDINO
AFFETTATRICE
FAMIGLIA A
VENTOSA M5 /
SUPPORT FOR SLICER
M5



3105050 PIEDINO
VENTOSA ALTO M6
H.45mm /
FOOT P.6 H. 42 mm



H=45mm, A=45mm,
Ø=6mm

3105042 PIEDINO
PER AFFETTATRICE
M8 H35mm /
SLICER SUPPORT H
33mm D.8mm



H=35mm, A=47mm,
Ø=8mm

3105035 PIEDINO A
VENTO D.40 H.10 /
FOOT D.40 H.10



3105023 PIEDINO
BASE ESAGONALE
INOX 55/65
REGOLABILE M10 /
STAINLESS STEEL
SUPPORT 55/65 M10



H min=55mm,
H max=65mm,
A=33mm, Ø=10mm

3105061 PIEDE INOX
H100/150 VITE M10X40
/
LEG INOX H100 / 150
SCREW M10x40
M021100020:
COLD LINE S.R.L.



3105056 PIEDINO
INOX Ø60
REGOLABILE H=12-
19cm /
ADJUSTABLE FOOT
STAINLESS Ø60 H = 12-
19cm
1000090:
KRUPPS S.R.L.



3105003 PIEDINO
COMPLETO Z9/S10 /
COMPLETE SUPPORT
Z9/S10
10090011:
RANCILIO SPA



H=41mm, Ø=10mm

3105043 PIEDINO
INOX 132/178
REGOLABILE M10 /
DEVICE LEG M10
20613:
BREMA ICE MAKERS
SPA
923066:
BRICE ITALIA SRL



Hmin=132mm,
Hmax=178mm,
A=40mm, Ø=10mm

3105006 PIEDINO
INOX 130/195
REGOLABILE M12 /
STAINLESS STEEL
SUPPORT LS 1105
15890135:
RANCILIO SPA
331223:
HOONVED - ALI SPA
331223:
COMENDA ALI SPA

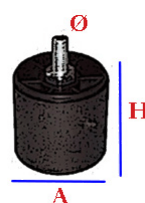

H min=130mm, H
max=195mm, A=51mm,
Ø=12mm

3105044 PIEDINO
INOX 160/268 M12 /
STAINLESS STEEL
DEVICE LEG 160/268
M12



3105033 "PIEDE IN ACCIAIO INOSSIDABILE 2''' C/F H=1''' / "STAINLESS STEEL FOOT C/F H=1'''''



926117:

ELETTROBAR
DIVISIONE DELLA
EUROTEC SRL

3105048 PIEDINO REGOLABILE RESINA / ADJUSTABLE FOOT RESIN



H=17mm, HTot=39mm,
A=27mm, Ø=17mm

K01086:

ARISTARCO KASTEL
SPA
10017:
BREMA ICE MAKERS
SPA

3105060 PIEDINO REGOLABILE IN PLASTICA NERO ALTO / ADJUSTABLE FOOT PLASTIC BLACK HIGH



H=20mm, HTot=50mm,
A=27mm, Ø=17mm

DW10851:

DIHR-ALI SPA

3105038 PIEDINO ESAGONALE PER LAVABICCHIERI / GLASS-WASHERS SUPPORT



461010:

ELETTROBAR
DIVISIONE DELLA
EUROTEC SRL

3105028 PIEDINO GOMMA NERA NE AC / BLACK RUBBER FOOT S90 NE SE

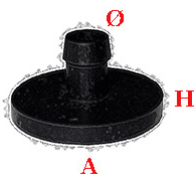

H=5mm, A=34mm,
Ø=10mm

210404:

COMENDA ALI SPA
H210404:
HOONVED - ALI SPA

3105020 GOMMINO PER PIEDINO MAGISTER / RUBBER FOOT FOR Magister

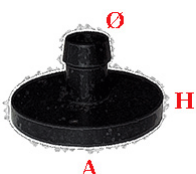

H=6mm, A=55mm,
Ø=20mm

030040:

MAGISTER SISTEMA
CAFFE' SRL

3105053 PIEDINO DURO / FOOT HARD
C00071614:
MACAP SRL



3105055 PIEDINO / FOOT
PR60009: FABA SRL

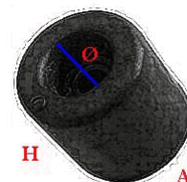

H=18mm, A=18mm,
Ø=8mm

3105018 RIALZO PIEDINO H48mm / SUPPORT H46mm



A=77mm, H=48mm

3105041 PIEDINO H 100 MM / ICE MAKER SUPPORT H 100 MM
10040:



H=100mm, A=50mm,
Ø=38mm

BREMA ICE MAKERS
SPA

3105047 PIEDINO / SUPPORT
66063800:
SCOTSMAN ICE SRL
CMNM66063800:
CASTEL MAC SPA



Øb=58mm, H=143mm,
Øa=51mm

3105049 KIT PIEDINI (4 PEZZI) / EQUIPMENT FEET KIT (4 PEACES)
65067000:
SCOTSMAN ICE SRL



3105058 KIT PIEDINI MODELLO KLP7 / KIT FEET MODEL KLP7
KLP7:
SCOTSMAN ICE SRL



3105027 PIEDE
ALLUMINIO
COMPLETO */C/
COMPLETE
ALUMINIUM LEGS
620222:
COMENDA ALI SPA
H620222:
HOONVED - ALI SPA

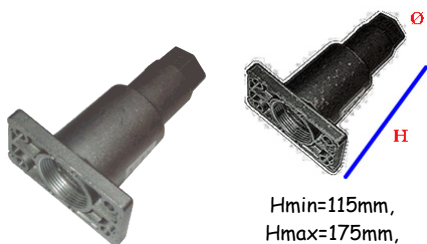

Hmin=115mm,
Hmax=175mm,
BASE=62X110mm,
Ø=43mm

1125172 PORTAGOM
MA M12x4 90° 1821-94 /
HOSETAIL M12x4 90°
1821-94
0200147:
LAMBER SRL



1125165 "RACC.
GOMITO 1/4" +RACC.
D.10 " /
ELBOW 1/4 " +
FITTING D.10
908100:
SILANOS SRL



1125149 GHIERA DI
RIDUZIONE 1/4"x3/8"
SENZA BATTUTA /
RING NUT 1/4"x3/8"



1125221 "RIDUZIONE
3/8"-1/4" INOX da
TORN."
/ INOX REDUCTION
3/8"-1/4"
35273:
HOONVED - ALI SPA



1125225 PORTAGOM
MA D.12 AD ANGOLO /
ANGLED RUBBER-
HOLDER D.12
8478: A.T.A. SRL



1125150 RACCORDO
VALV. A 90° BRILL.H/C
/
HOSE CONNECTOR 90°
35392:
HOONVED - ALI SPA



1125176 RACCORDO
PORTAGOMMA /
FITTING HOLDER
RUBBER



1125121 PORTAGOM
MA 90°1/2" X 12" /
"RUBBER HOLDER
90°1/2" X 12" "
510403:
COMENDA ALI SPA



1125213 RACCORDO
PORTAGOMMA
RISCIACQUO DA 3/8 M
- Ø10 /
RINSE RUBBER
HOLDER JUNCTION 3/8
M - Ø10
104350: KRUPPS S.R.L.



1125115 RACC.
PORTAGOMMA M D.8
3/8x ADDOLCITORE
AUTOMATICO /
RUBBER-HOLDER M
D.8 3/8



1125116 RACC.
PORTAGOMMA M D.13
3/8 /
RUBBER-HOLDER M
D.13 3/8



1125071 PORTAGOM
MA F1/8 X 6 /
RUBBER-HOLDER F1/8
X 6



1125175 RACCORDO
VALVOLA /
FITTING VALVE



1125179 RACCORDO
IN OTTONE 3/8
PORTAGOMMA D12 /
BRASS CONNECTOR
3/8 HOSE CONNECTION
D12
927015:
ELETTRORBAR



1125157 RACCORDO
CORPO POMPA FIR M16
/
BODY PUMP
CONNECTION FIR M16
9180010:
GRUPPO CIMBALI SPA



1125167 RACCORDO
POMPA M12 /
BODY PUMP
CONNECTION M12
4758:
UNIVER-BAR SRL

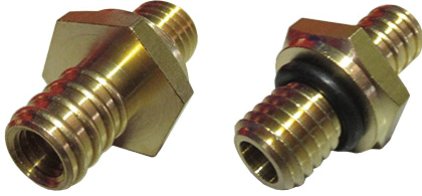

1125219 RACCORDO
POMPA M12 /
FITTING PUMP M12

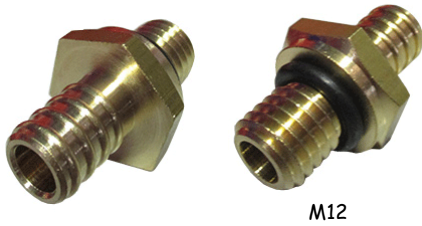

M12

1125038 RACC.
SERPENTINA VAPORE /
STEAM COIL
CONNECTION
280512:
COMENDA ALI SPA



1125034 PORTAGOMMA
MA OTTONE M.14X1 /
BRASS HOSE NOZZLE
M.14X1
34767:
HOONVED - ALI SPA



1125182 "RACCORDO
PORTAGOMMA F
1/2"X14" /
FITTING HOLDER
RUBBER-F 1/2 " X14 "



1125041 RACCORDO
DRITTO 3/8" C70 C155 /
"CONNECTION
STRAIGHT
3/8" B41C30"
190309:
COMENDA ALI SPA



1125122 RACCORDO
POMPETTA SCARICO /
DRAIN PIPE
CONNECTION
31621:
HOONVED - ALI SPA



1125162 "RACCORDO
DOPPIO G 3/4" X 36" /
EXTENSION THREAD
3/4" X 36" FOR WASH
DISTRIBUTOR
3501019:
WINTERHALTER
ITALIA SRL



1125211 RACCORDO
PORTAGOMMA /
RUBBER HOLDER
JUNCTION
468172:
ELETTOBAR
DIVISIONE DELLA
EUROTEC SRL



Ø=6mm

1125088 RACCORDO
1200322/1 /
JUNCTION 1200322/1



1125166 RACCORDO
3/8" /
FITTING 3/8 "
1549:
UNIVER-BAR SRL



1125087 RACCORDO
PER ACQUA CALDA
RANC. /
JUNCTION FOR HOT
WATER RANC.



1125138 NIPPLES 1/2"
M CROMATO - F PASSO
METRICO /
"NIPLES 1/2" M"



GASKET= 2107162

1125217 RACCORDO
/
JUNCTION
0C0710:
ELECTROLUX
PROFESSIONAL S.P.A.



1125128 RACCORDO
IN OTTONE 1/2X14
UMLL CROMATO /
BRASS JUNCTION
1/2X14 UMLL
929081:
ELETTOBAR
DIVISIONE DELLA
EUROTEC SRL



1125218 "GOMITO
3/8"" F/F INOX" /
INOX ELBOW
JUNCTION 3/8 F/F
35272:
HOONVED - ALI SPA



1125171 "GOMITO
MF 3/4"" /
ELBOW MF 3/4" ""



1125174 RACCORDO
GAS 1/4M /
GAS FITTING 1/4M



1125032 RACCORDO
TIPO BAR /
JOINT TYPE BAR
210074:
MAGISTER SISTEMA
CAFFE' SRL



1125033 RACCORDO
ALIMENTAZIONE
RISCIACQUO /
FITTING SUPPLY
RINSE
34155:
HOONVED - ALI SPA



3118019 RACCORDO
BOILER /POMPETTA
BRILLANTANTE /
DOSING PUMP/BOILER
JUNCTION
00010502:
ELFRAMO SPA



= 4127078

1125195 RACCORDO
BOILER/POMPA
BRILLANTANTE M10 /
FITTING BOILER /
PUMP RINSE M10
00010514:
ELFRAMO SPA



1125153 RACCORDO
RAPIDO 10-3/8"
X6101077 /
CONNECTION 10-3/8" X
6101077



1125154 RACCORDO
RAPIDO 8-3/8" /
CONNECTION 8-3/8"



6103018 PALMARE
PROGRAMMAZIONE
SCHEDA /
PC BOARD
PROGRAMMING
5831: A.T.A. SRL



1106025 TERMOM
ETRO DIGITALE
50+260° /
DIGITAL
THERMOMETER
50+260°
1106025:
UNIVERSALE



1106131 TERMOM
ETRO INFRAROSSI -
18+260° /
INFRA-RED
THERMOMETER -
18+260°
:



6103003 RILEVAT
ORE DI FUGHE
FREON SNOSE /
GAS LEAK
DETECTOR FREON
SNOSE
:



6103004 BILANCIA
TASCABILE 150GR.
DIV 0,05 /
DIGITAL SCALE
150GR. DIV 0,05
:



6103009 BILANCIA
DIGITALE 100GR.
MOD. TANITA /
DIGITAL SCALE
100GR. MOD.
TANITA



6103012 PHMETRO
DIGITALE USO
ALIMENTARE /
DIGITAL PHMETER



6103015 PHMETRO
DIGITALE
PORTATILE CON
SONDA /
DIGITAL PHMETER
WITH PROBE



6103007 LAMPAD
A FLUORESCENTE
RS-8 /
LAMPE RS-8
:





Corso Sempione 238/8 - 21052 Busto Arsizio -VA- Italy
phone 0039 0331 324053 - fax 0039 0331 671063

C.F. - P.IVA IT 02980880120

Società Unipersonale - Cap. Soc. € 10.000,00 i.v. - Iscr. Reg. Imprese di VA. 02980880120

info@sep-spareparts.com -- www.sep-spareparts.com