

S&P



Ice&Cold

**Ice&Cold Catalogue
2017**



S&P

**Corso Sempione 238/8
21052 Busto Arsizio (VA)
ITALY**

phone: +39.0331.324053



fax: +39.0331.671063



Come ordinare, how to order, comment commander, Wie konnes Sie bestellen, Como ordinar :

Phone: +39.0331.324053

Fax : +39.0331.671063

E-mail: info.sep-spareparts.com

Ricambi fuori catalogo

preghiamo, nel limite del possibile, di fornire i seguenti dati:

- Nome del costruttore
- Modello dell'apparecchiatura
- Numero matricola ed anno costruzione

Spare parts out of catalogue

Please give us the following data:

- Manufacturer's name
- Machine's model
- Serial number and manufacture year

Pièces hors catalogue

Veuillez nous fournir les données suivantes :

- Nome du constructeur
- Model de la machine
- Numéro de série et année de fabrication

Ersatzteile, die im Katalog nicht enthalten sind

Im Rahmen des Möglichen, bitten wir Sie, um folgenden daten uns mitzuteilen und zwar:

- Name des Herstellers
- Maschinenmodell
- Fabriknummer und Herstellungsjahr

Repuestos fuera del catalogo

Les pedimos que en el limite de lo posible proporcionar los siguientes datos:

- Nombre del constructor
- Modelo del aparato
- Numero de matricula y año de construcción

In questo catalogo sono raffigurati i materiali più rappresentativi e di maggior importanza; a richiesta sono disponibili gli articoli specifici per i marchi più diffusi.

This catalogue shows the most representative and important materials; at request, the specific items of the well-known stamps are available.

Ce catalogue montre les matériels plus représentatifs et de majeure importance; à requête, les articles spécifiques des maisons plus connues sont disponibles.

In diesem Katalog sind die wichtigsten Artikel dargestellt; auf Wunsch sind bestimmte Artikel der meistverbreitesten Firmen verfügbar.

En este catalogo se presentan los materiales más representativos y de mayor importancia; sobre pedido están disponibles los artículos específicos de las marcas más conocidas.

Le informazioni contenute in questo catalogo sono soggette a modifiche senza preavviso.

Nessuna parte di questo catalogo può essere riprodotta in qualsiasi forma o mezzo elettronico o meccanico, per alcun uso, senza il permesso scritto della S&P.

The information you find in this catalogue can be modified without advise.

This catalogue cannot be reproduced in any form and electronic or mechanical means without the express written authorisation of S&P.

Les reinseignements de ce catalogue peuvent être modifiés sans avis.

Ce catalogue ne peut pas être reproduit avec n'importe quelle forme ou moyen électronique ou mécanique sans autorisation écrite exprimée de la S&P.

Die in diesem Katalog enthaltenen Angaben können ohne Vorbehalten geändert werden.

Ohne schriftliche Genehmigung von der Firma S&P, kann keine Seite von diesem Handbuch entweder elektronisch oder mechanisch für kein Ziel vervielfältigt werden.

Las informaciones contenidas en este catalogo estan sujetas a modificaciones sin pre aviso.

Ninguna parte de este catalogo puede ser reproducida en cualquier forma o medio electrónico o mecánico para algún uso sin el permiso escrito de la S&P.

Condizioni generali

Prezzi: Le quotazioni esposte nei listini si intendono indicative e possono essere soggette a variazioni senza preavviso.

I prezzi non comprendono spese di trasporto, imballaggio, IVA ed eventuali altri oneri accessori; le spese per emissione di ricevute bancarie e tratte sono a carico del Cliente.

Resa della merce: Il materiale si intende venduto franco ns. magazzino, e pertanto l'obbligo di fornitura si intende assolto con la presa in consegna della merce da parte del trasportatore. La merce viaggia sempre, anche in caso di porto franco destino, a rischio e pericolo del Committente e, salvo precise disposizioni da parte del medesimo, l'inoltro della merce a destino verrà effettuato nel modo da noi ritenuto più idoneo, senza che ciò comporti alcuna responsabilità da parte della S&P, che non potrà essere ritenuta responsabile di eventuali ritardi o disguidi causati dal vettore.

Reclami: La S&P agisce quale rivenditore di materiali prodotti da terzi, non può pertanto assumersi responsabilità riferita ad eventuali difetti degli stessi. Qualsiasi reclamo dovrà essere indirizzato ad S&P con lettera o fax entro e non oltre otto (8) giorni dal ricevimento della merce.

Responsabilità: La S&P non si assume nessuna responsabilità per quanto riguarda i dati tecnici e le caratteristiche riportate nei propri cataloghi, né per le variazioni che le singole case costruttrici dovessero apportare.

Sale terms

Prices: The prices are indicative and can be changed without advice.

The costs of transport, packaging and eventual charges are not included in the prices.

Delivery terms: Ex-works

Complaints: S&P is a reseller so is not responsible for material defects. Every complaint has to be sent to S&P by fax or letter within 8 days on receipt of the goods.

Responsability: The S&P is not responsible for technic data or manufacture changes indicate in the catalogue.

Conditions générales de vente

Prix: Les prix sont indicatifs et peuvent être sujets à modifications sans avis. Ils ne comprennent costs de transport, emballage et charges eventuelles.

Délais de livraison: Ex-works.

Réclamations: La S&P est revendeur de matériel de tiers donc ne peut pas être responsable de eventuels défauts de fabrication. Les réclamations doivent être envoyées par fax ou lettre dans 8 jours de reception de la marchandise.

Responsabilité : La S&P n'est pas responsable pour les données techniques indiquées dans le catalogue ainsi que les variations faites des constructeurs.

Allgemeine Bedingungen

Preise: Die in unserer Liste angegebenen Preise können ohne Vorankündigung geändert werden. Transportkosten, Verpackung und eventuelle zusätzlichen Kosten sind in den Preisen nicht inbegriffen.

Lieferung: Ex-works.

Reklamationen: Eventuelle Reklamationen müssen schriftlich direkt an die Firma S&P innerhalb von 8 Tagen nach Warenerhalt vorgebracht werden.

Verantwortlichkeit: Die Richtigkeit der im katalog von verschiedenen Herstellern angegebenen technischen Angaben und Maße sind ohne Gewähr.

Condiciones generales

Precios: La cotizaciones espuestas en la lista se entienden indicativas y pueden ser sujetas a variaciones sin preaviso.

Los precios no comprenden gastos de transporte, embalaje y eventuales gastos accesorios.

Devolucion de la mercaderia: Ex-works.





Reclamos: La S&P actua como revendedor de materiales producidos por terceros, portanto no puede asumirse responsabilidad referida a eventuales defectos de los mismos productos. Cualquier reclamo tendrá que ser indirisado a la S&P con carta o fax entre y no depues de 8 dias del recevimiento de la mercanti

Responsabilidad: La S&P no se asume ninguna responsabilidad por quanto riguarda los datos tecnicos y las características reportadas en los propios catalogos ni por las variaciones que la singulas casas constructoras trendrian che aportar.

INDEX Cold & Ice 2017

Description	Cod.	Example					Page
Addolcitori Water Softeners	6101						231
Articoli complementari Parts for technicians	-----						234
Cavi Cables	1128						91
Centraline elettroniche P.C. Boards	1114						70
Cerniere per porta Door Hinges	8111						163
Complementi tecnici Technical Parts	1143						127
Compressori compressors	1137						113
Condensatori Capacitors	1135						106
Cricchetti Whole Pawls	3125						161
Elementi sensibili Sensitive Elements	1129						93
Elettropompe Pumps	1103						21
Elettrovalvole Solenoid Valves	1124						78
Filtri Filters	3126						124
Getti spruzzatori Nozzles	3102						159

INDEX Cold & Ice 2017

Description	Cod.	Example					Page
Giranti Fans	3109						172
Griglie Grills	4137						227
Guarnizioni Gaskets	2101						128
Guarnizioni per porte frigoriferi Door Gaskets for refrigerators	2103						131
Interruttori Switches	1105						35
Manicotti Sleeves	2108						152
Maniglie Handles	3108						162
Microinterruttori Micro-switches	1107						52
Molle Springs	1117						76
Motoriduttori Moto-reducers	1134						99
Orifici Orifices	4105						111
Palette Mixer Arms and Small Scoops	1127						91
Piedini Supports	3105						159
Pressostati Pressure Switches	1113						68
Raccordi di scarico Drain Junctions	3124						169

INDEX Cold & Ice 2017

Description	Cod.	Example				Page
Relè-contattori Relays - Contactors	1109					61
Resistenze Heating Elements	1101					232
Tappi troppo-pieno Overflows	3111					171
Termostati Thermostats	1106					39
Timer-temporizzatori Timers	1112					65
Tubi di carico Load Pipes	2110					155
Tubi scarico Drain Pipes	2109					155
Valvole termostatiche Thermostatic valves	4127					111
Vari fabbricatore di ghiaccio Parts for Ice Makers	4114 4122					173
Vari granitori Parts for slush	4119					223

INDEX Cold & Ice 2017

Technical Notes

Filettature/edgings

1/8"	Ø 5/10 mm
1/4"	Ø 8/13 mm
3/8"	Ø 12/17 mm
1/2"	Ø 15/21 mm
3/4"	Ø 20/27 mm
1"	Ø 26/34 mm
1"1/4	Ø 33/42 mm
1"1/2	Ø 40/49 mm
2"	Ø 50/60 mm

Elettricità/electricity

Legge di Ohm / Ohm's law : $V = R \times I$

Potenza delle resistenze / heating elements power: $P = V \times I$

V = Volt

R = Ohm

I = Ampere

P = Watt

Potenze/powers

1 HP =	= 735,5 W
1 Kcal/h =	= 1,163 W

Sezione fili da rispettare in funzione della corrente utile/ Current flowing vs wires size to observe

Corrente utile/current	Sezione dei fili/wires size
$I \leq 16 A$	1,5
$16 A < I \leq 20 A$	2,5
$20 A < I \leq 32 A$	4
$32 A < I \leq 50 A$	6
$50 A < I \leq 63 A$	10

Temperature/temperatures

Fahrenheit	= $C^{\circ} \times 9/5 + 32$
Celsius	= $(^{\circ}F - 32) \times 5/9$

Durezza H₂O/Hardness H₂O

(LT Resina/Resin x 5000)

_____ = LT acqua addolcita/softened water x ciclo/cycle
Durezza/Hardness H₂O (°F)

SCHEDE TECNICHE / TECHNICAL SPECIFICATIONS

Per alcune categorie di prodotto sono state inserite nuove schede tecniche. Da esse è possibile ricavare i vari ricambi correlati al codice a cui si riferiscono e anche vederli.

For some kind of products we did new technical specifications. By looking at them it's possible to see parts or spares linked to the code they refer.

Esempio/Example: codice/code 1103001: POMPA 0,10 HP MANDATA DX/ANTICLOCKWISE PUMP 0,10 HP

Specifica tecnica/Technical information:

es/i.e: a = aspirazione pompa/pump entry =
misura/measure = 28mm

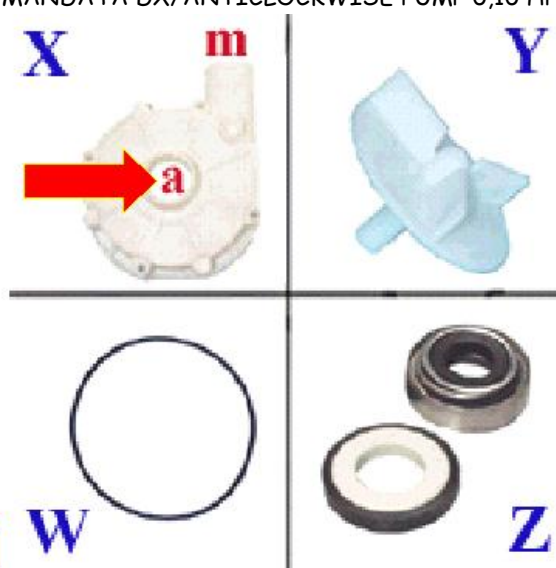

Coordinate e codice corrispondente /

Coordinates and correspondent code:

es/i.e: W= guarnizione pompa/pump gasket=codice S&P
S&P code 2104004

X= 1103148, a= 28mm,
m= 28mm, Y= 3109017,
W= 2104004, Z= 3110026

CONTROLLO DELLE DIMENSIONI O-RINGS

MEASUREMENT OF THE O-RINGS SIZES

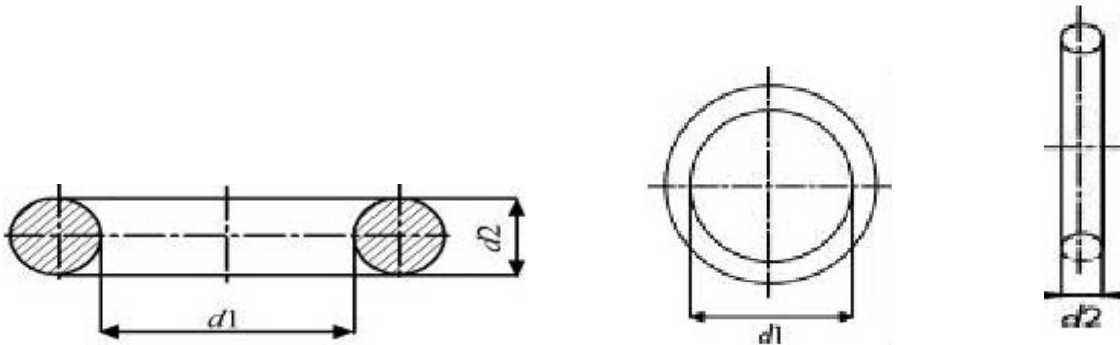

d1: diametro interno
d1: internal diameter
d1: diamètre intérieur
d1: diámetro interior

d2: spessore OR (diametro della corda)
d2: OR thickness (torus)
d2: épaisseur OR
d2: OR espesor

-Il controllo di D1 e D2 viene fatto in base alle tolleranze della tabella ISO 3601 (ex DIN 3771) parte 1.

-The measurement of D1 and D2 is carried out on the basis of the tolerances of the table ISO 3601 (ex DIN 3771) part 1.

Esempio di misurazione delle OR: codice **2101303**: (d1) 3,69 x (d2) 1,78

How to measure O-Rings: example code **2101303**: (d1) 3,69 x (d2) 1,78

d1: 3,69 diametro interno OR/ OR internal diameter

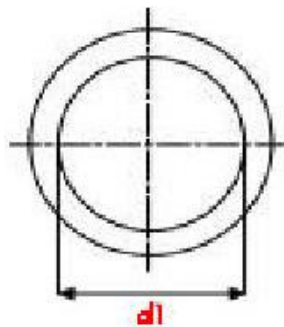

d2: 1,78 diametro della corda OR/OR thickness (torus)

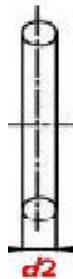

S&P O-RINGS NBR

Codice/Code	Descrizione/Description d1xd2	Codice/Code	Descrizione/Description d1xd2
2101300	1,78X1,78 O-RING	2101346	88,64X1,78 O-RING
2101301	2,57X1,78 O-RING	2101347	91,70X1,78 O-RING
2101302	2,90X1,78 O-RING	2101348	95,00X1,78 O-RING
2101303	3,69X1,78 O-RING	2101349	98,05X1,78 O-RING
2101304	4,47X1,78 O-RING	2101350	101,34X1,78 O-RING
2101305	5,28X1,78 O-RING	2101351	104,40X1,78 O-RING
2101306	6,07X1,78 O-RING	2101352	107,70X1,78 O-RING
2101307	6,35X1,78 O-RING	2101353	114,00X1,78 O-RING
2101308	6,75X1,78 O-RING	2101354	117,10X1,78 O-RING
2101309	7,66X1,78 O-RING	2101355	120,40X1,78 O-RING
2101310	8,73X1,78 O-RING	2101356	133,10X1,78 O-RING
2101311	9,25X1,78 O-RING	2101357	142,11X1,78 O-RING
2101312	10,82X1,78 O-RING	2101358	161,16X1,78 O-RING
2101313	11,11X1,78 O-RING	2101359	164,34X1,78 O-RING
2101314	12,42X1,78 O-RING	2101360	2,20X1,90 O-RING
2101315	14,00X1,78 O-RING	2101361	2,40X1,90 O-RING
2101316	15,60X1,78 O-RING	2101362	2,60X1,90 O-RING
2101317	17,16X1,78 O-RING	2101363	3,40X1,90 O-RING
2101318	18,77X1,78 O-RING	2101364	4,20X1,90 O-RING
2101319	20,35X1,78 O-RING	2101365	4,90X1,90 O-RING
2101320	21,95X1,78 O-RING	2101366	5,70X1,90 O-RING
2101321	23,52X1,78 O-RING	2101367	6,40X1,90 O-RING
2101322	25,12X1,78 O-RING	2101368	7,20X1,90 O-RING
2101323	26,70X1,78 O-RING	2101369	8,00X1,90 O-RING
2101324	28,30X1,78 O-RING	2101370	8,90X1,90 O-RING
2101325	29,87X1,78 O-RING	2101371	2,84X2,62 O-RING
2101326	31,47X1,78 O-RING	2101372	3,63X2,62 O-RING
2101327	33,05X1,78 O-RING	2101373	4,42X2,62 O-RING
2101328	34,65X1,78 O-RING	2101374	5,23X2,62 O-RING
2101329	36,27X1,78 O-RING	2101375	6,02X2,62 O-RING
2101330	37,82X1,78 O-RING	2101376	7,60X2,62 O-RING
2101331	39,45X1,78 O-RING	2101377	9,13X2,62 O-RING
2101332	41,00X1,78 O-RING	2101378	9,19X2,62 O-RING
2101333	44,17X1,78 O-RING	2101379	9,92X2,62 O-RING
2101334	47,37X1,78 O-RING	2101380	10,78X2,62 O-RING
2101335	50,52X1,78 O-RING	2101381	11,91X2,62 O-RING
2101336	53,67X1,78 O-RING	2101382	12,37X2,62 O-RING
2101337	56,87X1,78 O-RING	2101383	13,10X2,62 O-RING
2101338	60,04X1,78 O-RING	2101384	13,95X2,62 O-RING
2101339	63,22X1,78 O-RING	2101385	15,08X2,62 O-RING
2101340	66,40X1,78 O-RING	2101386	15,54X2,62 O-RING
2101341	69,57X1,78 O-RING	2101387	15,88X2,62 O-RING
2101342	72,76X1,78 O-RING	2101388	17,13X2,62 O-RING
2101343	75,94X1,78 O-RING	2101389	17,86X2,62 O-RING
2101344	79,00X1,78 O-RING	2101390	18,72X2,62 O-RING
2101345	82,28X1,78 O-RING	2101391	20,29X2,62 O-RING

S&P O-RINGS NBR

Codice/Code	Descrizione/Description d1xd2	Codice/Code	Descrizione/Description d1xd2
2101392	20,64X2,62 O-RING	2101438	139,38X2,62 O-RING
2101393	21,90X2,62 O-RING	2101439	145,73X2,62 O-RING
2101394	22,23X2,62 O-RING	2101440	152,07X2,62 O-RING
2101395	23,47X2,62 O-RING	2101441	158,43X2,62 O-RING
2101396	23,81X2,62 O-RING	2101442	164,78X2,62 O-RING
2101397	25,07X2,62 O-RING	2101443	171,13X2,62 O-RING
2101398	26,65X2,62 O-RING	2101444	177,48X2,62 O-RING
2101399	28,25X2,62 O-RING	2101445	183,83X2,62 O-RING
2101400	29,83X2,62 O-RING	2101446	196,53X2,62 O-RING
2101401	31,42X2,62 O-RING	2101447	202,88X2,62 O-RING
2101402	33,00X2,62 O-RING	2101448	209,23X2,62 O-RING
2101403	34,60X2,62 O-RING	2101449	221,93X2,62 O-RING
2101404	36,17X2,62 O-RING	2101450	228,28X2,62 O-RING
2101405	37,77X2,62 O-RING	2101451	234,63X2,62 O-RING
2101406	39,35X2,62 O-RING	2101452	240,98X2,62 O-RING
2101407	40,95X2,62 O-RING	2101453	8,90X2,70 O-RING
2101408	42,52X2,62 O-RING	2101454	10,50X2,70 O-RING
2101409	44,12X2,62 O-RING	2101455	12,10X2,70 O-RING
2101410	45,70X2,62 O-RING	2101456	13,60X2,70 O-RING
2101411	47,30X2,62 O-RING	2101457	15,10X2,70 O-RING
2101412	48,90X2,62 O-RING	2101458	16,90X2,70 O-RING
2101413	50,47X2,62 O-RING	2101459	18,40X2,70 O-RING
2101414	52,07X2,62 O-RING	2101460	4,34X3,53 O-RING
2101415	53,65X2,62 O-RING	2101461	7,52X3,53 O-RING
2101416	55,25X2,62 O-RING	2101462	9,12X3,53 O-RING
2101417	56,82X2,62 O-RING	2101463	15,47X3,53 O-RING
2101418	58,42X2,62 O-RING	2101464	18,64X3,53 O-RING
2101419	60,00X2,62 O-RING	2101465	20,22X3,53 O-RING
2101420	61,60X2,62 O-RING	2101466	21,82X3,53 O-RING
2101421	63,17X2,62 O-RING	2101467	23,40X3,53 O-RING
2101422	64,77X2,62 O-RING	2101468	25,00X3,53 O-RING
2101423	66,35X2,62 O-RING	2101469	25,80X3,53 O-RING
2101424	67,95X2,62 O-RING	2101470	26,57X3,53 O-RING
2101425	69,52X2,62 O-RING	2101471	28,17X3,53 O-RING
2101426	71,12X2,62 O-RING	2101472	29,75X3,53 O-RING
2101427	72,70X2,62 O-RING	2101473	31,34X3,53 O-RING
2101428	75,88X2,62 O-RING	2101474	32,93X3,53 O-RING
2101429	80,60X2,62 O-RING	2101475	34,52X3,53 O-RING
2101430	82,22X2,62 O-RING	2101476	36,10X3,53 O-RING
2101431	88,58X2,62 O-RING	2101477	37,70X3,53 O-RING
2101432	94,93X2,62 O-RING	2101478	39,70X3,53 O-RING
2101433	101,28X2,62 O-RING	2101479	40,87X3,53 O-RING
2101434	113,98X2,62 O-RING	2101480	41,28X3,53 O-RING
2101435	120,33X2,62 O-RING	2101481	42,86X3,53 O-RING
2101436	126,67X2,62 O-RING	2101482	44,05X3,53 O-RING
2101437	133,00X2,62 O-RING	2101483	44,45X3,53 O-RING

S&P O-RINGS NBR

Codice/Code	Descrizione/Description d1xd2	Codice/Code	Descrizione/Description d1xd2
2101484	46,04X3,53 O-RING	2101530	139,30X3,53 O-RING
2101485	47,23X3,53 O-RING	2101531	142,47X3,53 O-RING
2101486	47,62X3,53 O-RING	2101532	145,65X3,53 O-RING
2101487	49,20X3,53 O-RING	2101533	148,82X3,53 O-RING
2101488	50,40X3,53 O-RING	2101534	152,00X3,53 O-RING
2101489	50,80X3,53 O-RING	2101535	158,35X3,53 O-RING
2101490	52,40X3,53 O-RING	2101536	164,70X3,53 O-RING
2101491	53,57X3,53 O-RING	2101537	171,05X3,53 O-RING
2101492	53,97X3,53 O-RING	2101538	177,40X3,53 O-RING
2101493	55,56X3,53 O-RING	2101539	183,75X3,53 O-RING
2101494	56,75X3,53 O-RING	2101540	190,10X3,53 O-RING
2101495	57,15X3,53 O-RING	2101541	196,45X3,53 O-RING
2101496	58,74X3,53 O-RING	2101542	202,80X3,53 O-RING
2101497	59,92X3,53 O-RING	2101543	209,15X3,53 O-RING
2101498	60,32X3,53 O-RING	2101544	215,50X3,53 O-RING
2101499	61,90X3,53 O-RING	2101545	221,85X3,53 O-RING
2101500	63,10X3,53 O-RING	2101546	228,20X3,53 O-RING
2101501	65,10X3,53 O-RING	2101547	234,55X3,53 O-RING
2101502	66,27X3,53 O-RING	2101548	240,90X3,53 O-RING
2101503	66,67X3,53 O-RING	2101549	247,25X3,35 O-RING
2101504	68,26X3,53 O-RING	2101550	253,60X3,53 O-RING
2101505	69,85X3,53 O-RING	2101551	266,30X3,53 O-RING
2101506	71,44X3,53 O-RING	2101552	279,00X3,53 O-RING
2101507	69,44X3,53 O-RING	2101553	291,70X3,53 O-RING
2101508	72,62X3,53 O-RING	2101554	304,40X3,53 O-RING
2101509	73,02X3,53 O-RING	2101555	329,80X3,53 O-RING
2101510	74,60X3,53 O-RING	2101556	355,20X3,53 O-RING
2101511	75,80X3,53 O-RING	2101557	380,60 X3,53 O-RING
2101512	78,97X3,53 O-RING	2101558	405,26X 3,53 O-RING
2101513	82,14X3,53 O-RING	2101559	430,66X3,53 O-RING
2101514	85,32X3,53 O-RING	2101560	18,30X3,60 O-RING
2101515	88,50X3,53 O-RING	2101561	19,80X3,60 O-RING
2101516	91,67X3,53 O-RING	2101562	21,30X3,60 O-RING
2101517	94,84X3,53 O-RING	2101563	23,00X3,60 O-RING
2101518	101,2X3,53 O-RING	2101564	24,60X3,60 O-RING
2101519	104,37X3,53 O-RING	2101565	26,20X3,60 O-RING
2101520	107,54X3,53 O-RING	2101566	27,80X3,60 O-RING
2101521	110,72X3,53 O-RING	2101567	29,30X3,60 O-RING
2101522	113,90X3,53 O-RING	2101568	30,80X3,60 O-RING
2101523	117,07X3,53 O-RING	2101569	32,50X3,60 O-RING
2101524	120,24X3,53 O-RING	2101570	34,10X3,60 O-RING
2101525	123,42X3,53 O-RING	2101571	35,60X3,60 O-RING
2101526	126,60X3,53 O-RING	2101572	37,30X3,60 O-RING
2101527	129,77X3,53 O-RING	2101573	16,81X5,34 O-RING
2101528	132,94X3,53 O-RING	2101574	18,42X5,34 O-RING
2101529	136,12X3,53 O-RING	2101575	24,77X5,34 O-RING

S&P O-RINGS NBR

Codice/Code	Descrizione/Description d1xd2	Codice/Code	Descrizione/Description d1xd2
2101576	27,94X5,34 O-RING	2101625	142,24X5,34 O-RING
2101577	29,51X 5,34 O-RING	2101626	142,88X5,34 O-RING
2101578	31,12X5,34 O-RING	2101627	145,42X5,34 O-RING
2101579	34,29X5,34 O-RING	2101628	146,05X5,34 O-RING
2101581	40,65X5,34 O-RING	2101629	148,60X5,34 O-RING
2101582	43,82X5,34 O-RING	2101630	149,23X5,64 O-RING
2101584	50,16X5,34 O-RING	2101631	151,77X5,34 O-RING
2101585	53,34X5,34 O-RING	2101632	158,12X5,34 O-RING
2101587	59,70X5,34 O-RING	2101633	164,47X5,34 O-RING
2101588	62,87X5,34 O-RING	2101634	170,82X5,34 O-RING
2101589	66,04X5,34 O-RING	2101635	177,17X5,34 O-RING
2101590	69,22X5,34 O-RING	2101636	183,52X5,34 O-RING
2101591	72,40X5,34 O-RING	2101637	189,87X5,34 O-RING
2101592	74,63X5,34 O-RING	2101638	196,22X5,34 O-RING
2101593	75,57X5,34 O-RING	2101639	202,57X5,34 O-RING
2101594	78,74X5,34 O-RING	2101640	208,92X5,34 O-RING
2101595	79,77X5,34 O-RING	2101641	215,27X5,34 O-RING
2101596	81,92X5,34 O-RING	2101642	221,62X5,34 O-RING
2101597	85,10X5,34 O-RING	2101643	227,97X 5,34 O-RING
2101598	88,27X5,34 O-RING	2101644	278,77X5,34 O-RING
2101599	89,69X5,34 O-RING	2101645	291,47X5,34 O-RING
2101600	91,44X5,34 O-RING	2101646	304,17X5,34 O-RING
2101601	94,62X5,34 O-RING	2101647	380,37X5,34 O-RING
2101602	97,80X5,34 O-RING	2101648	405,26X5,34 O-RING
2101603	100,00X5,34 O-RING	2101649	430,66X5,34 O-RING
2101604	100,97X5,34 O-RING	2101650	481,46X5,34 O-RING
2101605	104,14X5,34 O-RING	2101651	113,67X6,99 O-RING
2101606	107,32X5,34 O-RING	2101652	114,70X6,99 O-RING
2101607	109,54X5,43 O-RING	2101653	116,84X6,99 O-RING
2101608	110,50X5,3 4 O-RING	2101654	120,02X6,99 O-RING
2101609	113,67,5,34 O-RING	2101655	123,20X6,99 O-RING
2101610	116,84X5,34 O-RING	2101656	124,60X6,99 O-RING
2101611	117,48X5,34 O-RING	2101657	126,37X6,99 O-RING
2101612	120,02X5,34 O-RING	2101658	129,54X6,99 O-RING
2101613	120,65X5,34 O-RING	2101659	132,72X6,99 O-RING
2101614	123,20X5,34 O-RING	2101660	134,50X6,99 O-RING
2101615	123,83X5,34 O-RING	2101661	135,90X6,99 O-RING
2101616	126,37X5,34 O-RING	2101662	139,07X6,99 O-RING
2101617	127,00X5,34 O-RING	2101663	142,24X6,99 O-RING
2101618	129,54X5,34 O-RING	2101664	145,42X6,99 O-RING
2101619	130,18X5,34 O-RING	2101665	148,60,X6,99 O-RING
2101620	132,72X5,34 O-RING	2101666	151,77X6,99 O-RING
2101621	133,35X5,34 O-RING	2101667	155,60X6,99 O-RING
2101622	135,90X5,34 O-RING	2101668	158,12X6,99 O-RING
2101623	136,53X5,34 O-RING	2101669	159,50X6,99 O-RING
2101624	139,70X5,34 O-RING	2101670	161,90X6,99 O-RING

S&P O-RINGS NBR

Codice/Code	Descrizione/Description d1xd2	Codice/Code	Descrizione/Description d1xd2
2101671	164,47X6,99 O-RING	2101717	98,02X3,53 O-RING
2101672	166,70X6,99 O-RING	2101118	37X1,5 O-RING
2101673	168,30X6,99 O-RING	2101119	58X1,5 O-RING
2101674	170,82X6,99 O-RING	2101132	2X9,5X13,5 O-RING
2101675	174,60X6,99 O-RING	2101137	1X7X9 O-RING
2101676	177,17X6,99 O-RING	2101151	6X3X12 O-RING
2101677	181,00X6,99 O-RING	2101152	81X87X3 O-RING
2101678	183,52X6,99 O-RING	2101153	43X49X3 O-RING
2101679	187,30X6,99 O-RING	2101156	70X94X2 O-RING
2101680	189,87X6,99 O-RING	2101187	13X2X17 O-RING
2101681	193,70X6,99 O-RING	2101231	28X2,5 O-RING
2101682	196,22X6,99 O-RING	2101031	37X5,33 O-RING
2101683	200,00X6,99 O-RING	2101032	46,99X5,33 O-RING
2101684	202,57X6,99 O-RING	2101033	56,52X5,33 O-RING
2101685	208,92X6,99 O-RING		
2101686	215,27X6,99 O-RING		
2101687	221,62X6,99 O-RING		
2101688	227,97X6,99 O-RING		
2101689	234,32X6,99 O-RING		
2101690	240,67X6,99 O-RING		
2101691	247,00X6,99 O-RING		
2101692	253,57X6,99 O-RING		
2101693	259,70X6,99 O-RING		
2101694	266,07X6,99 O-RING		
2101695	272,40X6,99 O-RING		
2101696	278,77X6,99 O-RING		
2101697	285,10X6,99 O-RING		
2101698	291,47X6,99 O-RING		
2101699	304,17X6,99 O-RING		
2101700	316,87X6,99 O-RING		
2101701	329,57X6,99 O-RING		
2101702	342,27X6,99 O-RING		
2101703	354,97X6,99 O-RING		
2101704	367,67X6,99 O-RING		
2101705	380,37X6,99 O-RING		
2101706	393,07X6,99 O-RING		
2101707	405,26X6,99 O-RING		
2101708	417,96X6,99 O-RING		
2101709	430,66X6,99 O-RING		
2101710	443,36X6,99 O-RING		
2101711	456,06X6,99 O-RING		
2101712	468,76X6,99 O-RING		
2101713	481,46X6,99 O-RING		
2101714	494,16X6,99 O-RING		
2101715	506,86X6,99 O-RING		
2101716	63,50X3,53 O-RING		



**NIPPLES DOPPIO MM
MALE-MALE NIPPLES**

CODICE-CODE	MISURA-SIZE
1125008	3/8
1125019	1/8
1125091	1/4
1125092	1/2
1125093	3/4



**NIPPLES RIDOTTO MM
MALE-MALE REDUCED NIPPLE**

CODICE-CODE	MISURA-SIZE
1125014	1/4 - 3/8
1125015	1/8 - 1/4
1125017	3/8 - 1/2
1125044	1/2 - 1/4
1125045	3/8 - 3/4
1125046	1/2 - 3/4
1125047	1" - 1/2
1125048	1/2 - 1"1/4
1125049	3/4 - 1"
1125050	3/4 - 1"1/4
1125051	1" - 1"1/4
1125052	1" - 1"1/2
1125053	1" - 2"
1125054	1"1/4 - 1"1/2



**RIDUZIONE ESAGONALE
HEXAGONAL REDUCTION**

CODICE-CODE	MISURA-SIZE
1125020	3/4 - 3/8
1125043	1" - 1"1/4
1125055	1/8 - 1/4
1125056	1/8 - 3/8
1125057	1/4 - 3/8
1125058	1/4 - 1/2
1125059	3/8 - 1/2
1125060	1/2 - 3/4
1125061	1/2 - 1"
1125062	1/2 - 1"1/4
1125063	1/2 - 1"1/2
1125064	1/2 - 2"
1125065	3/4 - 1"
1125066	3/4 - 1"1/4
1125067	3/4 - 1"1/2
1125068	3/4 - 2"
1125069	1" - 1"1/2
1125070	1" - 2"



**RIDUZIONE ESAGONALE F-M
F-M HEXAGONAL REDUCTION**

CODICE-CODE	MISURA-SIZE
1125108	1/4 - 1/8
1125109	3/8 - 1/4
1125110	3/8 - 1/2
1125112	1/2 - 3/8
1125113	1/2 - 1/2
1125114	3/4 - 1/2
1125126	3/4 - 3/8



**RIDUZIONE ESAGONALE F-F
F-F HEXAGONAL REDUCTION**

CODICE-CODE	MISURA-SIZE
1125097	3/8 - 1/2
1125111	3/8 - 3/8



**GOMITO F-F
ELBOW JUNCTION F-F**

CODICE-CODE	MISURA-SIZE
1125117	1/2 - 1/2
1125118	3/4 - 3/4



**RACCORDO TRE VIE OTTONE TEE F-F-F
T HOLDER JUNCTION F-F-F**

CODICE-CODE	MISURA-SIZE
1125025	3/8 - 3/8 - 3/8
1125119	1/2 - 1/2 - 1/2
1125120	3/4 - 3/4 - 3/4

SERRAFILETTI PER RACCORDERIA



1143021 Serrafiletti omologato come sigillante per gas e acqua potabile, smontabile e resistente ad urti e vibrazioni.

Caratteristiche tecniche:

Diametro: M24

Gioco max : mm 0,20

Temperatura di impiego: -55° + 150°

1143021 Medium strength anaerobic adhesive for thread locking of nuts and bolts of all types that require to be dismantled. Suitable to be used on oily surfaces.

Highly resistant to heat, corrosion, vibrations, water, gas, oils, hydrocarbons and many chemicals.

Technical specifications:

Diameter: M24

Temperature range: -55° + 150°

1143014 Loctite 55 è un sottile nastro bianco multifilo, senza trama, di circa 1mm di larghezza per 0.25mm di spessore in grado di sigillare istantaneamente accordo filettato (fino a 6" di diametro), in plastica e metallo. Sostituisce canapa e nastri in PTFE.

Caratteristiche tecniche:

Sigillatura di componenti filettati, come giunzioni e raccordi per tubi; sigilla fluidi e non fino alla temperatura di 150°C. E' particolarmente adatto in caso di utilizzo immediato dell'impianto e dove vi sia la necessità di un riposizionamento prima dell'uso.

1143014 Loctite 55 is a general purpose threaded pipe and fitting sealant. A non-curing coated multifilament cord that seals out air and other common gases and fluids.

Recommended for sealing metal and plastic tapered pipe fittings up to 4" NPT for use in industrial applications in aqueous and non-aqueous fluids. Particularly suitable in threaded assembly applications that require immediate use and may undergo small readjustments before use. This product is typically used in applications up to 149 °C.



THREADSEALING-THREADLOCKING



**GHIERA DI RIDUZIONE
REDUCTION METAL RING**

CODICE-CODE	MISURA-SIZE
1125074	3/8 - 1/2
1125075	1/2 - 3/4



**MANICOTTO FF
FEMALE-FEMALE JOINT**

CODICE-CODE	MISURA-SIZE
1125094	1/4
1125095	3/8
1125096	1/2



**TAPPO M
MALE CAP**

CODICE-CODE	MISURA-SIZE
1125098	1/8
1125099	1/4
1125100	3/8
1125101	1/2

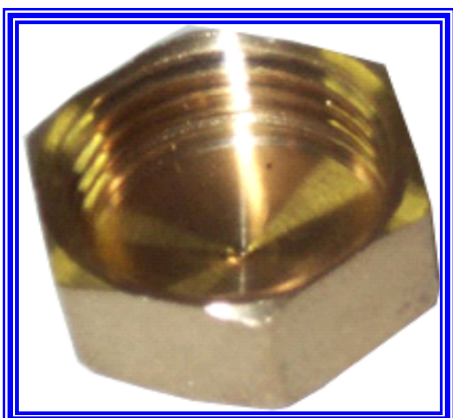

**TAPPO F
FEMALE CAP**

CODICE-CODE	MISURA-SIZE
1125102	1/4
1125103	3/8
1125104	1/2

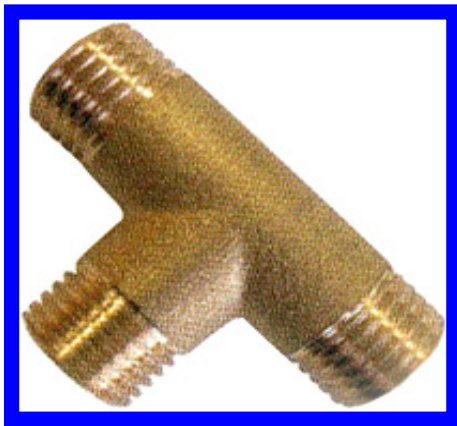

**RACCORDO TRE VIE OTTONE TEE M-M-M
T HOLDER JUNCTION M-M-M**

CODICE-CODE	MISURA-SIZE
1125140	1/4 - 1/4 - 1/4
1125141	3/8 - 3/8 - 3/8
1125142	1/2 - 1/2 - 1/2
1125143	3/4 - 3/4 - 3/4

1103027 KIT
UNIVERSALE POMPA
SCARICO 2 CALOTTE

DRAIN PUMP
UNIVERSAL KIT
AL41E, AL46E,
AF78E, ED, EDP,
AF88E: A.T.A. SRL
AL40ET, AL45ET,
AL40E, AL45E,
AL40PS, AL45PS.:

A.T.A. SRL
130105:
ELETTROBAR
65130105: RANCILIO
1103027: UNIVERSAL



230 V, body 1 Ø
23mm/23mm, body 2
Ø 30mm/34mm, 34
Watt

1103772 MOTORE
PER POMPA DI
SCARICO /
ENGINE FOR DRAIN
PUMP

4751: A.T.A. SRL



1103645 POMPA DI
SCARICO /
DRAIN PUMP

100519: I.T.V. S.A.
9041036*:

GRUPPO CIMBALI
SPA
984141000:
GRUPPO CIMBALI
SPA
926142:
BRICE ITALIA SRL

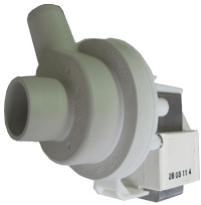

A=22mm, M=22mm,
COVER=1103670,
Dimensions 30-22 mm

1103552 POMPA
SCAR.HANNING DPS
25 50HZ /
DRAIN PUMP
HANNING DPS 25
50HZ

35093:
HOONVED - ALI SPA
100893:
COMENDA ALI SPA



A=30mm, M=23mm

1103450 POMPA KIT

PUMP KIT
OL0692:
ELECTROLUX
PROFESSIONAL
S.P.A.
048844EX:
ELECTROLUX
PROFESSIONAL
S.P.A.



1103709 POMPA
SCARICO RIVER /
DRAIN PUMP RIVER

80117: ELETTROBAR
130177:
ELETTROBAR



1103788 POMPA DI
SCARICO 63043 /
DRAIN PUMP

CEPS51:
OMNIWASH SRL -
SOCIETA' A SOCIO
UNICO



diemeter= 30mm //
23mm,

1103652 KIT
INSTALLAZIONE
POMPA DI SCARICO
35W /
DRAIN PUMP KIT 35W

DP50K: KRUPPS S.R.L.



1103680 POMPA SC.
4/82 220V 50HZ 63043 /
DRAIN PUMP 4/82
220V 50HZ 63043 EUR

CEPS5:
OMNIWASH SRL -
SOCIETA' A SOCIO
UNICO



Ø2
Ø1=30mm, Ø2=22mm,
BODY=1103789

1103670 CORPO
POMPA DI SCARICO /
DRAIN PUMP BODY



A=30mm, M=22mm

1103789 CALOTTA
PER POMPA 1103788 /
BODY FOR DRAIN
PUMP



Ø2
Ø1=30mm, Ø2=22mm

1103910 CORPO
POMPA DI SCARICO /
BODY DRAIN PUMP



A=24mm, M=24mm

1103011 POMPA
LIQUIDI X SIMAG /
LIQUID PUMP SIMAG
ZIID005:

SIMAG SPA

1103011:

UNIVERSALE

K01530:

ARISTARCO SPA

1103011: FAEMA

DS4''DP,DS600DP,DL

240DP,CF35DP,CF40

DP,CF50DP,DS400:

ADLER S.P.A.

251002:

SCOTSMAN ICE SRL

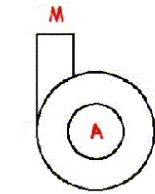

100W, A= 24mm,
M=24mm

1103500 PUMP /
PUMP

CMCF62047100:

CASTEL MAC SPA

62047100:

SCOTSMAN ICE SRL

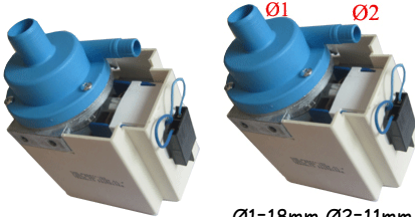

Ø1=18mm,Ø2=11mm

1103069 POMPA

CLB 190W

FABBR.GHIACCIO/LA

VATAZZE /

ICE MAKER PUMP

CLB 190W

*: I.T.V. S.A.

5010: KRUPPS S.R.L.

841104: TEIKOS SRL

1103069:

UNIVERSALE

MP-PS: MACH

1DR062: MIGEL

S.R.L.

GS202, GS215,

GS302, GS315:

WINTERHALTER

ITALIA SRL

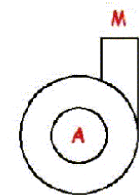

A= 24mm, M=24mm,
190 Watt, 230v

1103559 POMPA DI

SCARICO GRE CL.3 /

DRAIN PUMP GRE

CL.3

130112:

ELETTROBAR

DIVISIONE DELLA

EUROTEC SRL



1103417 POMPA DI

SCARICO 440V/60Hz /

DRAIN PUMP

440V/60HZ

FC543E:

COMENDA ALI SPA



1103364 POMPA

SC.100W 220V/50

C/FILTRO /

PUMP WITH FILTER

100W 220V/50

100803:

COMENDA ALI SPA



Ø2=22mm, H=172mm,
Ø1=30mm

1103207 POMPA DI

SCARICO SENZA

STAFFA /

DRAIN PUMP

WITHOUT STIRRUP

984141000:

GRUPPO CIMBALI

SPA

9041036:

GRUPPO CIMBALI

SPA

100342:

COMENDA ALI SPA

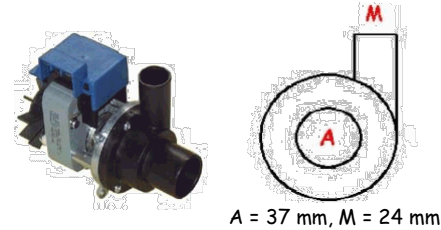

A = 37 mm, M = 24 mm

1103431 POMPA

M01KL18:31 230V

50Hz /

PUMP M01KL18:31

230V 50Hz

KL18-KL21-KL31:

MIGEL S.R.L.

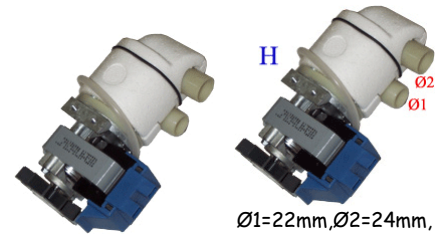

Ø1=22mm,Ø2=24mm,
H=190mm

1103433 POMPA

MIGEL KL41 /

PUMP MIGEL KL41

KL41-KI71:

MIGEL S.R.L.

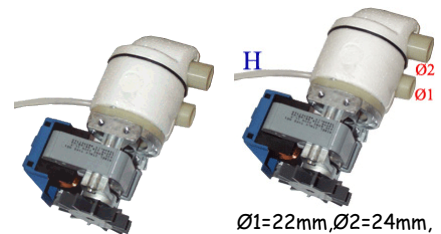

Ø1=22mm,Ø2=24mm,
H=190mm

1103905 POMPA K2

TF 230V/50Hz /

POMP FOR

ICEMAKERS K2 TF

230V/50Hz

2DR093:

MIGEL S.R.L.

2DR093:

MBM- EUROTEC SRL

- DIV. COOKING

SERVICE

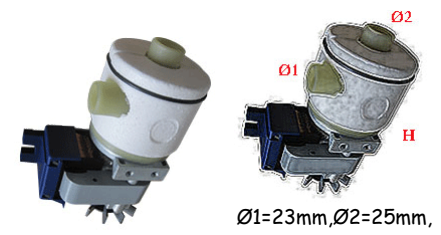

Ø1=23mm,Ø2=25mm,
H=170mm

1103782 POMPA

KL41:KL131 230v/60hz

/

PUMP KL41 / KL131

230V/60Hz

2DR202:

MIGEL S.R.L.

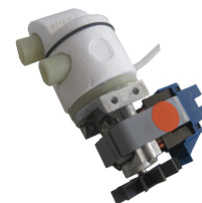

1103009 POMPA
SIMAG/FAEMARTIC /
PUMP
SIMAG/FAEMARTIC
SD60,SD22,SD23;
SIMAG SPA
OKM744:
ELECTROLUX
PROFESSIONAL
S.P.A.
SD80:
SCOTSMAN ICE SRL
1103009: FAEMA
06049103:
SCOTSMAN ICE SRL



1103006 POMPA
CB184 BREMA I°
VER.(55w-<416883) /
ICEBOX PUMP 15
BREMA
CB184,IC18:
BREMA ICE MAKERS
SPA
sl35: N.T.F. SRL
ICEBOX15, IBS21-4:
RANCLIO SPA
CFO7921010:
N.T.F. SRL

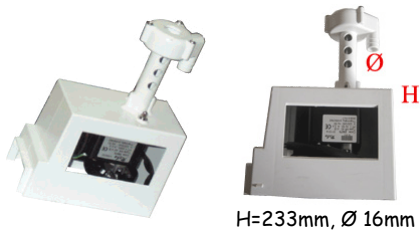

1103573 ASSIEME
POMPA CB184
NUOVO TIPO (45w-
>416883) /
PUMP
SL35: N.T.F. SRL
CB184:
BREMA ICE MAKERS
SPA



1103003 POMPA
FABBR.GHIACCIO
NTF 55W /
ICE MAKER PUMP
NTF
IC24,IC30:
BREMA ICE MAKERS
CFO7921011: N.T.F.
SRL
SL50,SL60,SL70,SL9
0,SL110: N.T.F. SRL
EUC23254:
BRICE ITALIA SRL

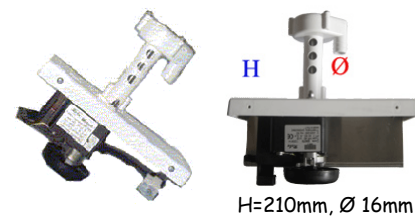

1103255 ASS.POMP
A 70W-220/50 -
SL140/200 /
PUMP 70W 220/50 - SL
140/200
SL140,SL180,SL200,
SL260: N.T.F. SRL
C23608:
BREMA ICE MAKERS
SPA

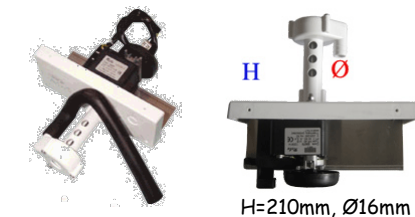

1103485 ASSIEME
POMPA 220/230V 60Hz
/
PUMP 220-230V 60HZ
NC23416: N.T.F. SRL
C23416:
BREMA ICE MAKERS
SPA

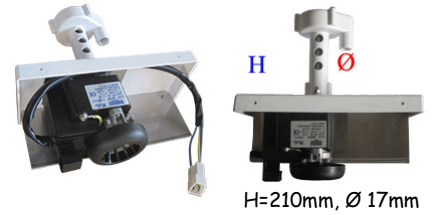

1103408 ASSIEME
POMPA /
PUMP
C23624:
BREMA ICE MAKERS
SPA

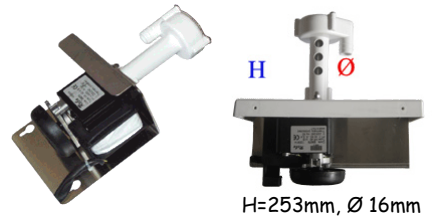

1103594 ASSIEME
POMPA /
PUMP
C23626:
BREMA ICE MAKERS
SPA
NC23626: N.T.F. SRL
EUC23626:
BRICE ITALIA SRL

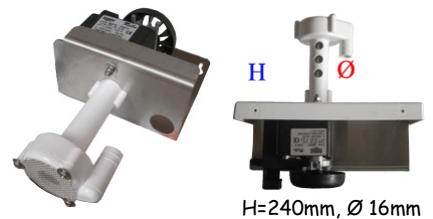

1103801 ASS.
POMPA ACQUA 2.0-3.0
V230M 50Hz /
WATER PUMP
ASSEMBLY 2.0-3.0
V230M 50Hz FOR ICE
MAKER
K02939:
ARISTARCO KASTEL
SPA

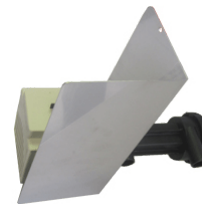

1103237 ASS.
POMPA E FILTRO /
PUMP + FILTER
MUSTER 350,
MUSTER 350 SPLIT:
BREMA ICE MAKERS
SPA

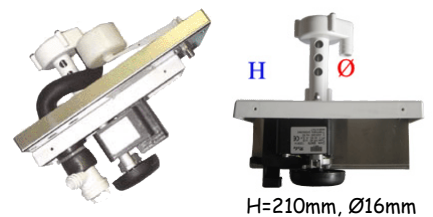

1103356 ASSIEME
POMPA E FILTRO /
PUMP+ FILTER
C26711:
BREMA ICE MAKERS
SPA

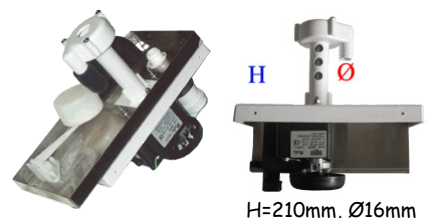

1103653 ASSIEME
POMPA E FILTRO /
ASSEMBLY PUMP
AND FILTER
C26738:
BREMA ICE MAKERS
SPA



1103692 ASSIEME
POMPA E FILTRO /
PUMP AND FILTER
MUSTER 2000:
BREMA ICE MAKERS
SPA
C26740:
BREMA ICE MAKERS
SPA

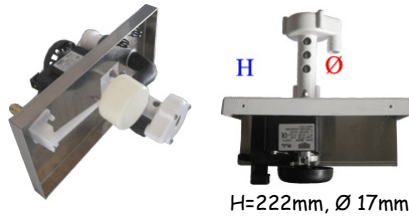

H=222mm, Ø 17mm

1103135 MOTORE
POMPA /
MOTOR PUMP
23073:
BREMA ICE MAKERS
SPA



1103186 MOTORE
POMPA H50 220/50 /
MOTOR PUMP H50
220/50
23600:
BREMA ICE MAKERS
SPA



1103455 MOTORE
POMPA P.50 -220/60/1 /
PUMP MOTOR P.50 -
220/60/1
N23601: N.T.F. SRL
23601: BREMA ICE



1103817 Motore
pompa 110V /
Pump motor 110V
23188:
BREMA ICE MAKERS
SPA



1103026 POMPA
ACQUA SCOTSMAN
AC125 /
WATER PUMP
SCOTSMAN 62043003
AC125,AC175,BARLI
NE65,BARLINE90,EC
125,EC175:
SCOTSMAN ICE
CM19550109/0:
CASTEL MAC SPA

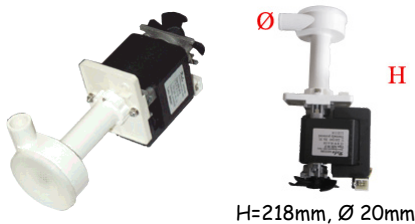

H=218mm, Ø 20mm

1103067 POMPA
AC225 SCOTSMAN /
PUMP AC225
SCOTSMAN
MC10,MC15,MC20,MC
45,AC225NEW:
SCOTSMAN ICE SRL



H=218mm, Ø 20mm

1103494 WATER
PUMP /
WATER PUMP
62042300:
SCOTSMAN ICE SRL
CMCF62042300:
CASTEL MAC SPA



H=218mm, Ø 12mm

1103524 WATER
PUMP 230V/60HZ/1PH
/
WATER PUMP
230V/60HZ/1PH
62043002:
SCOTSMAN ICE SRL



H=218mm, Ø 20mm

1103499 WATER
PUMP /
WATER PUMP
62043006:
SCOTSMAN ICE
SRL



H=220mm, Ø 20mm

1103075 WATER
PUMP 230V ACM125 /
WATER PUMP 230V
ACM125
MC15,
MC45,ACM125,ACM1
75,ACM225-MCM16:
SCOTSMAN ICE SRL
EX79314603:
SCOTSMAN ICE SRL
CMXG62043003:
CASTEL MAC SPA



H=220mm, Ø 20mm

1103596 WATER
PUMP 230V/60HZ/1PH
/
WATER PUMP
230V/60HZ/1PH
62043005:
SCOTSMAN ICE SRL



H=220mm, Ø=21mm

1103465 WATER
PUMP 230V/60HZ/1PH
/
WATER PUMP
230V/60HZ/1PH
086680:ELECTROLU
X
62043301:
SCOTSMAN ICE SRL



H=223mm, Ø 12mm

1103064 POMPA
ACM85 SCOTSMAN /
PUMP ACM85
SCOTSMAN
79311303EX:
SCOTSMAN ICE SRL
ACM125:
SCOTSMAN ICE SRL
CM195501120:
CASTEL MAC SPA
CM19550112/O:
CASTEL MAC SPA



H=225mm, Ø 18mm

1103262 POMPA
MH30F1 W30 220-
240/50CF /
PUMP MH30FW25 220-
240/50CF
CM19535157/O:
CASTEL MAC SPA
CM19535157/O:
CASTEL MAC SPA



H=225mm, Ø12mm

1103066 POMPA
ACM25-35 SCOTSMAN
/
PUMP ACM25-35
SCOTSMAN
32M6310: ANGELO
PO
BARLINE:20/21/30/
31/50/50,
EC046,EC056,EC085,
EC086,EC105,;
SCOTSMAN ICE SRL
RECOC489:
EURFRIGOR SRL
RECOC489:EURFRIG
OR
CM19550113/O :
CASTEL MAC SPA
AC045,
AC046,AC055,AC056,
AC085, AC086,,
AC105, AC106,EC045:
SCOTSMAN ICE SRL
EC106,ICE ONE,ICE
TWO,
MV:1000,300,450,60
0,800:
SCOTSMAN ICE SRL



H=225mm, Ø 12mm

1103338 POMPA
MH30F 25W 230/60/1 /
PUMP MH30F 25W
230/60/1 ICE-MAKER
CM19550114/O:
CASTEL MAC SPA



H=225mm, Ø12mm

1103339 POMPA
MH30FW25 220-
240/50CF /
PUMP MH30F 25W
220-240/50CF ICE-
MAKER
CM19550108/O:
CASTEL MAC SPA

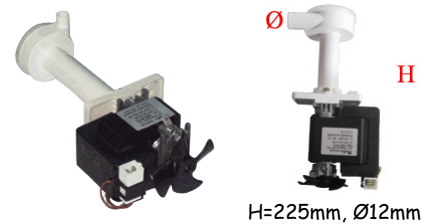

H=225mm, Ø12mm

1103371 WATER
PUMP /
WATER PUMP
79311317R:
SCOTSMAN ICE SRL



H= 235mm, Ø= 18mm

1103654 WATER
PUMP /
WATER PUMP
79311324R:
SCOTSMAN ICE SRL



H=245mm, Ø=18mm

1103533 WATER
PUMP /
WATER PUMP
79311312R:
SCOTSMAN ICE SRL



H=245mm, Ø 18mm

1103388 WATER
PUMP 230V/50HZ/1PH
CME506 /
WATER PUMP
230V/50HZ/1PH
CME506
79311309ex:
SCOTSMAN ICE SRL
62043302:
SCOTSMAN ICE SRL

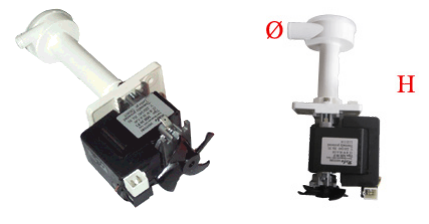

1103640 WATER
PUMP 230/60 /
WATER PUMP 230/60
62043008:
SCOTSMAN ICE SRL



1103807 WATER
PUMP 115V/60HZ/1PH
/
WATER PUMP
115V/60HZ/1PH
62043304:
SCOTSMAN ICE SRL

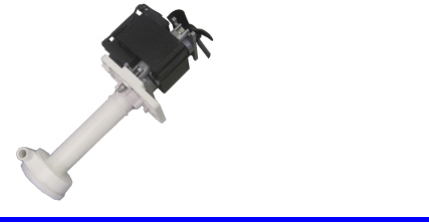

1103590 WATER PUMP / WATER PUMP
1200226022:
SCOTSMAN ICE SRL



1103544 WATER PUMP 230V / WATER PUMP
CME506-656-706:
SCOTSMAN ICE SRL



1103639 PUMP WATER 3000 RPM 230 V / PUMP WATER 3000 RPM 230 V
IOM916107903:
SCOTSMAN ICE SRL



1103590 WATER PUMP / WATER PUMP
1200226022:
SCOTSMAN ICE SRL



1103544 WATER PUMP 230V / WATER PUMP
CME506-656-706:
SCOTSMAN ICE SRL



1103639 PUMP WATER 3000 RPM 230 V / PUMP WATER 3000 RPM 230 V
IOM916107903:
SCOTSMAN ICE SRL



1103879 WATER PUMP / WATER PUMP
1200258621:
SCOTSMAN ICE SRL



H=220mm

1103926 WATER PUMP / WATER PUMP
1200292022:
SCOTSMAN ICE SRL



1103740 WATERPUMP / WATERPUMP
1200241962:
SCOTSMAN ICE SRL



1103642 WATER PUMP / WATER PUMP
1200226522:
SCOTSMAN ICE SRL



1103415 WATER PUMP / WATER PUMP
1200258627:
SCOTSMAN ICE SRL



1103666 WATER PUMP 230/50/1 / WATER PUMP 230/50/1
IOM916107602:
SCOTSMAN ICE SRL



1103464 WATER PUMP / WATER PUMP
1200258221:
SCOTSMAN ICE SRL



1103784 WATER PUMP / WATER PUMP
IOM916107902:
SCOTSMAN ICE SRL



1103580 WATER

PUMP /
WATER PUMP
67000216:

SCOTSMAN ICE SRL

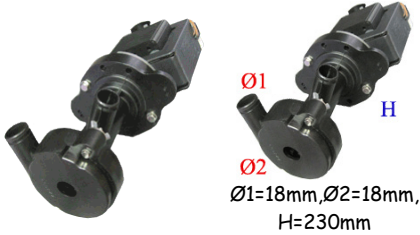

Ø1
Ø2
Ø1=18mm, Ø2=18mm,
H=230mm

1103065 POMPA ACM 45 SCOTSMAN / PUMP ACM 45 SCOTSMAN

ACM35OLD,
ACM50OLD:

SCOTSMAN ICE SRL

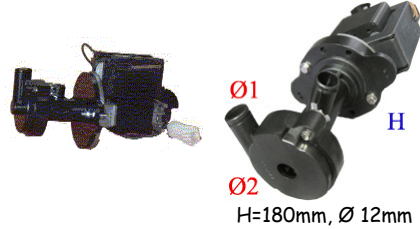

Ø1
Ø2
H=180mm, Ø 12mm

1103529 WATER

PUMP /
WATER PUMP
1200226321:

SCOTSMAN ICE SRL



Ø1
Ø2
Ø3
Ø1=18mm, Ø2=18mm,
Ø3=18mm, H=260mm

1103068 POMPA

ACL 200VS
SCOTSMAN /
PUMP ACL 200VS
SCOTSMAN

AC225OLD:
SCOTSMAN ICE SRL

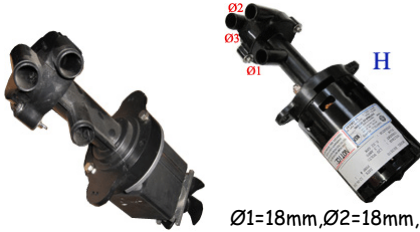

Ø1
Ø2
Ø3
Ø1=18mm, Ø2=18mm,
Ø3=18mm, H=245mm

1103879 WATER

PUMP /
WATER PUMP
1200258621:

SCOTSMAN ICE SRL



Ø1
Ø2
Ø1=16mm, Ø2=27mm,
H=220mm

1103812 WATER

PUMP / WATER PUMP
1200225622:
SCOTSMAN ICE SRL



1103573 ASSIEME

POMPA CB184
NUOVO TIPO (45w-
>416883) /
PUMP

SL35: N.T.F. SRL
CB184:

BREMA ICE MAKERS



H=233mm, Ø 16mm

SPA

1103003 POMPA

FABBR.GHIACCIO
NTF 55W /
ICE MAKER PUMP
NTF

IC24, IC30: BREMA
CF07921011: N.T.F.
SRL

SL50, SL60, SL70, SL9
0, SL110; N.T.F. SRL
EUC23254:

BRICE ITALIA SRL

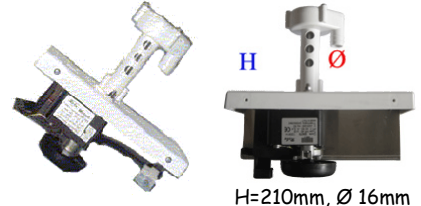

H=210mm, Ø 16mm

1103255 ASS.POMP

A 70W-220/50 -
SL140/200 /
PUMP 70W 220/50 - SL
140/200

SL140, SL180, SL200,
SL260: N.T.F. SRL
C23608:

BREMA ICE MAKERS

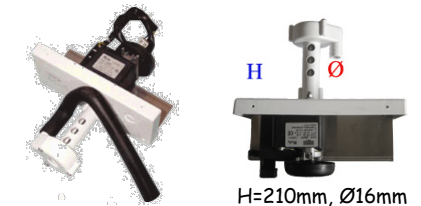

H=210mm, Ø16mm

1103485 ASSIEME

POMPA 220/230V 60Hz
/
PUMP 220-230V 60HZ
NC23416: N.T.F. SRL
C23416:

BREMA ICE MAKERS
SPA

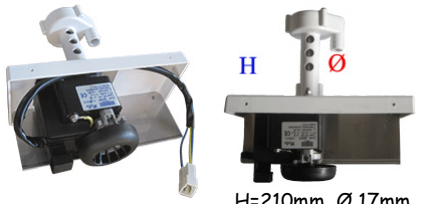

H=210mm, Ø 17mm

1103408 ASSIEME

POMPA /
PUMP
C23624:

BREMA ICE MAKERS
SPA



H=253mm, Ø 16mm

1103594 ASSIEME

POMPA /
PUMP
C23626:

BREMA ICE MAKERS
SPA
NC23626: N.T.F. SRL
EUC23626:

BRICE ITALIA SRL

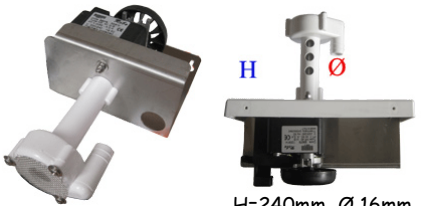

H=240mm, Ø 16mm

1103801 ASS.

POMPA ACQUA 2.0-3.0
V230M 50Hz /
WATER PUMP
ASSEMBLY 2.0-3.0
V230M 50Hz FOR ICE
MAKER

K02939:
ARISTARCO KASTEL
SPA



1103237 ASS.
POMPA E FILTRO /
PUMP + FILTER
MUSTER 350,
MUSTER 350 SPLIT:
BREMA ICE MAKERS
SPA

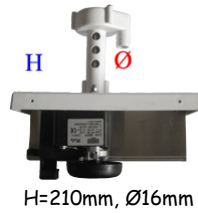

1103356 ASSIEME
POMPA E FILTRO /
PUMP+ FILTER
C26711:
BREMA ICE MAKERS
SPA



1103653 ASSIEME
POMPA E FILTRO /
ASSEMBLY PUMP
AND FILTER
C26738:
BREMA ICE MAKERS
SPA

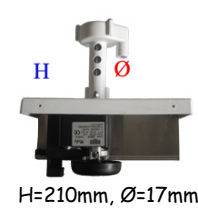

1103692 ASSIEME
POMPA E FILTRO /
PUMP AND FILTER
MUSTER 2000:
BREMA ICE MAKERS
SPA
C26740:
BREMA ICE MAKERS
SPA



1103135 MOTORE
POMPA /
MOTOR PUMP
23073:
BREMA ICE MAKERS
SPA



1103186 MOTORE
POMPA H50 220/50 /
MOTOR PUMP H50
220/50
23600:
BREMA ICE MAKERS
SPA



1103455 MOTORE
POMPA P.50 -220/60/1 /
PUMP MOTOR P.50 -
220/60/1
N23601: N.T.F. SRL
23601:
BREMA ICE MAKERS
SPA



1103720 MOTORE
POMPA /
MOTOR PUMP
23818:
BREMA ICE MAKERS
SPA



H=215mm, Ø 18mm

1103836 WATER
PUMP 230/60/1 /
WATER PUMP 230/60/1
CM81454638:
SCOTSMAN ICE SRL
CM81454638/O:
CASTEL MAC SPA



1103908 WATER
PUMP RETROFIT KIT /
WATER PUMP
RETROFIT KIT
CM81452001:
SCOTSMAN ICE SRL
CM81452001/O:
CASTEL MAC SPA



1103715 ELETTROP
OMPA MODELLO
30.82.223.01 /
PUMP 30.82.223.01
205407: I.T.V. S.A.
5407: I.T.V. S.A.



1103632 POMPA
FABBRICATORE ITV
DELTA /
PUMP ITV DELTA
5125: I.T.V. S.A.



1103314 POMPA
FABBRICATORE DI
GHIACCIO IGNIS
WHIRLPOOL /
ICE MAKER PUMP
IGNIS WHIRLPOOL



1103612 POMPA
ACQUA GIRANTE 48
230V 50HZ /
WATER PUMP 48 230V
50HZ
K01206:
ARISTARCO KASTEL
SPA
K00553:
ARISTARCO KASTEL
SPA



1103531 ASSIEME
POMPA ACQUA 125
160 150 /
WATER PUMP
ASSEMBLY 125 160
150

K01164:
ARISTARCO KASTEL
SPA



1103002 POMPA
ACQUA BREMA 25/80
/
WATER PUMP BREMA
25/80 Kg

1103002: MBM
CB246,CB249,CB316,
CB416,CB425,CB640,
CB840,CB955,C80,*:
BREMA ICE MAKERS
SPA

CM150: N.T.F. SRL
ICEBOX25,30,40,45,
60,80-IBS: 24-6,33-
16, 46-25,65-40,90-
55:

RANCILIO SPA
085322:
ELECTROLUX
C23002:
BREMA ICE MAKERS

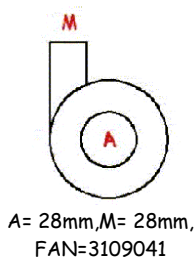
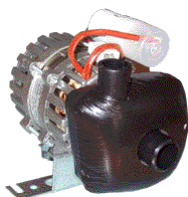

A= 28mm,M= 28mm,
FAN=3109041

1103010 POMPA
FABB,GHIACCIO
120KG BR. /
ICE MAKER PUMP
120KG BREMA

C23068:
BREMA ICE MAKERS
085340:
ELECTROLUX
PROFESSIONAL
S.P.A.

CB1265,CB1565,C150,
C300:

BREMA ICE MAKERS
SL280,SL350,CM350,
CM650: N.T.F. SRL
ICEBOX120,150,IBS1
30-65,IS155:

RANCILIO SPA

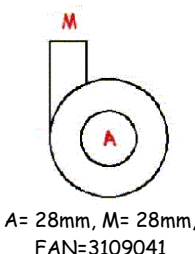
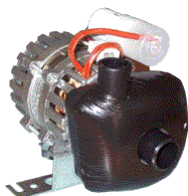

A= 28mm, M= 28mm,
FAN=3109041

1103238 POMPA
ACQUA BREMA
CB246/CB955 TN
(>0303) /
WATER PUMP BREMA
CB246/CB955 TN
4240.2300:

BREMA ICE MAKERS
SPA
NEW: IBS24-6,
IBS33-16, IBS46-25,
IBS65-40, IBS90-55:
RANCILIO SPA
NEW: CB840, CB955,
C80, DSS42:

BREMA ICE MAKERS



SPA

EUC23377:

BRICE ITALIA SRL
NEW: CB246, CB249,
CB316, CB416, CB425,
CB640:

BREMA ICE MAKERS
SPA
NC23377: N.T.F. SRL

1103373 POMPA /
PUMP

NC23691: N.T.F. SRL
C23691:

BREMA ICE MAKERS
SPA



1103376 POMPA
220/50-60 GIRANTE 65
/
PUMP 220/50-60
LAUFRAD 65

C23462:
BREMA ICE MAKERS
N23462: N.T.F. SRL
926152: BRICE
ITALIA



1103660 ASSIEME
POMPA 110V /
PUMP 110V

C23663:
BREMA ICE MAKERS
SPA



1103731 POMPA
PER DECALCIFICARE
/
DECALCIFY PUMP



1103039 MOTORE
PENTAVALENTE 5W /
PENTA-ABLE MOTOR
5W

RECOC487:
EURFRIGOR SRL



5 Watt, 230volt

1103022 MOTORE
PENTAVALENTE 10W
/
PENTA-ABLE MOTOR
10W

MA25314399:
MARENO
INDUSTRIE ALI SPA



10 Watt 230v

1103023 MOTORE
PENTAVALENTE 16W
/
PENTA-ABLE MOTOR
16W



16 Watt 230v

1103040 MOTORE
PENTAVALENTE 25W
/
PENTA-ABLE MOTOR
25W



25 Watt, 230v

1103044 MOTORE
34W 220V /
PENTA-ABLE MOTOR
34W 220V



34 Watt, 230v

1103297 MOTORE
PENTAVALENTE
4P19-B30/15 /
PENTA-ABLE MOTOR
40/15



926120: BRICE
ITALIA
C150, C300, CB1565,
G500, G250, VM900,
VM500, VM350;
BREMA ICE MAKERS
MUSTER 800,
MUSTER350:
BREMA ICE MAKERS

1103739 MOTOV.AS
S.93-120W230V /
FAN MOTOR
32M5840:
ANGELO PO GRANDI
CUCINE SPA



1103369 MOTORE
VENT. F100 E F120
FAN MOTOR FOR
F100-F120
62041902:
SCOTSMAN ICE SRL
CMCF62041902:
CASTEL MAC SPA



1103920 "VENTILAT
ORE; WITH CABLE
L=2030MM" 10/38W /
FAN MOTOR WITH
CABLE L=2030MM
084745:
ELECTROLUX
PROFESSIONAL
S.P.A.



1103921 "MOTORE;
230V 50/60HZ 16W" /
MOTOR 230V 50/60HZ
18W



0A8419:
ELECTROLUX
PROFESSIONAL
S.P.A.

1103818 MOTORE
VENTILATORE/POMP
A 230V 50Hz VASCA
5L /
FAN MOTOR / PUMP
230V 50Hz -TANK 5L
2280018980:
UGOLINI SPA



1103745 Motore
ventilatore /
fan motor

23580EX:
BREMA ICE MAKERS
SPA
23426EX:
BREMA ICE MAKERS
SPA
23681:
BREMA ICE MAKERS
SPA



1103702 VENTILAT
ORE 5W EC20-30-40 /
FAN 5W EC20-30-40
926085:
BRICE ITALIA SRL



1103492 MOT.VENT
ILAT.VN10/20 -220/50-
60/1 /
FAN MOTOR
N23029: N.T.F. SRL
23029:
BREMA ICE MAKERS
SPA
926148:
BRICE ITALIA SRL



1103582 MOTOVEN
TILATORE 11W 250/26
230V/50HZ /
FANMOTOR 11W
250/26 230V/50HZ
1LT003: MIGEL S.R.L.



1103683 MOTORE /
MOTOR
SL34000075:
GBG ALI SPA



1103678 MOTORE
ASINCRONO
MONOFASE /
MOTOR

RD000509:
EURFRIGOR SRL
RD000510:
EURFRIGOR SRL
*: BRICE ITALIA
SRL



1103056 VENTOLA
200MM 28 /
HELICAL TURBINE
200MM D. 28



1103057 VENTOLA
230MM 28 /
HELICAL TURBINE
230MM D. 28

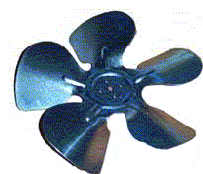

1103058 VENTOLA
254MM 22 /
HELICAL TURBINE
254MM D. 22



1103059 VENTOLA
300MM 22 /
HELICAL TURBINE
300MM D. 22

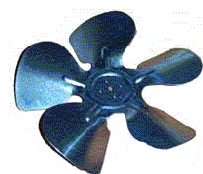

1103060 STAFFA
72MM /
STIRRUP 72MM



1103061 STAFFA
84MM /
STIRRUP 84MM



1103062 STAFFA
METALLO H 108MM
36 /
STIRRUP 108MM D. 36



1103686 VENTILAT
ORE ASSIALE
80X80X25
CUSCINETTI /
AXIAL FAN 80X80X25
05BA0012002:
SPM DRINK
SYSTEMS
006125:
ELECTROLUX
PROFESSIONAL
S.P.A.



1103685 VENTILAT
ORE ASSIALE
120X120X25MM
CUSCINETTI /
AXIAL FAN
120X120X25MM



1103687 VENTILAT
ORE ASSIALE
120X120X38MM
CUSCINETTI /
AXIAL FAN
120X120X38MM
3380006900:
UGOLINI SPA
1648110107:
POLARIS/BARON
ALI
10724: FOINOX
S.P.A.
ES39100: OEM ALI
OC4106:
ELECTROLUX
BN3102350:
OLIS DIVISIONE DI
ALI GROUP SPA -
LAR65060050:
LAINOX ALI SPA



1103864 VENTILAT
ORE PANNELLO
COMANDI
80X80X38MM /
FAN CONTROL
PANEL 80X80X38MM
77045:
ELETTRORAR
DIVISIONE DELLA
EUROTEC SRL



DIMENSION= 80 X
80 X 38 MM

1103747 Motore
ventilatore /
FAN MOTOR
23856:
**BREMA ICE MAKERS
SPA**



1103659 VENTOLIN
A DI
RAFFREDDAMENTO /
FAN
SL37TAH0401:
GBG ALI SPA
SL37TAH0401:
GBG ALI SPA



1103843 VENTOLA
ASPIRAZIONE 24V /
FAN SUCTION 24V
998057000:
**CASADIO HBS SRL
A SOCIO UNICO**



DIMENSION=40X40
X20mm

1103466 VENTILAT
ORE FORNO ZANUSSI
0C4423 /
OVEN FAN ZANUSSI
0C4423
0C4423:
**ELECTROLUX
PROFESSIONAL
S.P.A.**



1103726 VENTOLA
24VDC 92X92X25
F.TUNN. /
FAN 24VDC 92X92X25
ES27800:
OEM ALI SPA



1114419 VENTOLA
RAFFREDAMENTODI
SPLAY /
FAN DISPLAY
CLASSE 10:
RANCILIO SPA



1103832 VENTILAT
ORE PROTETTO INOX
1V+DISC.PROT. /
Fan PROTECTED
STAINLESS 1V +
DISC.PROT
32M6610:
**ANGELO PO GRANDI
CUCINE SPA**



1103919 MOTOVEN
T. EBM tipo:A4E350-
AA06-01 50Hz 140W /
FAN MOTOR EBM
TYPE:A4E350-AA06-01
50Hz 140W
23468:
**BREMA ICE MAKERS
SPA**



1103909 MOTOVEN
TILATORE /
FAN MOTOR
088603:
**ELECTROLUX
PROFESSIONAL
S.P.A.**

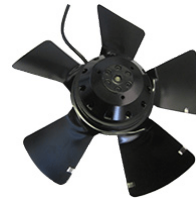

1103870 MOTOVEN
TILATORE EBM
A4D500-AM03-01 CON
GRIGLIA SENZA
CAVO /
FAN MOTOR WITH
GRID EBM A4D500-
AM03-01
23839:
**BREMA ICE MAKERS
SPA**



4122352 VENTILAT
ORE HIDRIA 0309-4-
1072230-240/1/50-60 /
FAN MOTOR HIDRIA
0309-4-1072230-240 / 1 /
50-60
CM18562559/2:
CASTEL MAC SPA



1103775 MOTOVEN
TILATORE IRF /
MOTOR FAN IRF



1103579 VENTOLA
ILSA TRPZ2P -C4 /
FAN ILSA TRPZ2P -C4



1103776 ASS.ROTO
RE SF300/500/1000 /
ROTOR ASSY FOR
SF300/500/1000
CMCF79421600:
CASTEL MAC SPA



1103416 FAN

MOTOR /
FAN MOTOR
1200168103:
SCOTSMAN ICE SRL
1200168123:
SCOTSMAN ICE SRL



1103574 MOTOR

FAN 50W /
MOTOR FAN 50W
1800550512:
SIMAG SPA
1800550512:
SCOTSMAN ICE SRL



1103667 FAN

MOTOR /
FAN MOTOR
1800874002:
SCOTSMAN ICE SRL



1103916 MOTOR

35W 208-230V 50/60Hz
/
MOTOR 35W 208-230V
50/60Hz
1800873604:
SCOTSMAN ICE SRL
IOM916107802:
SCOTSMAN ICE SRL



1103760 FANMOTO

R /
FANMOTOR
1800550501:
SCOTSMAN ICE SRL



1103507 FAN

MOTOR /
FAN MOTOR
62049000:
SCOTSMAN ICE SRL
62027300:
SCOTSMAN ICE SRL
62027303:
SCOTSMAN ICE SRL



1103856 VENTILAT

ORE TANGENZIALE
180-15 DX /
TANGENTIAL FAN
180-15 DX



HETING
ELEMMENT=1101833

1103328 VENTILAT

ORE TANGENZIALE
CB /
TANGENTIAL MOTOR
CB
VR-EV-ESP/2: CB SRL



1103512 VENTILAT

ORE CELLA 230V
QLK45/1200A39-2513L
/
VENTILATOR WITH
TRAVERSE FLOW
MA2590900:
MARENO
INDUSTRIE ALI SPA



L=120mm

1103857 VENTILAT

ORE TANGENZIALE
180-15 SX /
TANGENTIAL FAN
180-15 SX



HETING
ELEMMENT=1101833

1103749 MOTOV.TA

NG.X COND.220-240
50/60 -> /
CROSS FLOW FAN
220-240 50/60
4022141: MONDIAL



1103828 MOTOVEN

TILATORE
TANGENZIALE CON
STAFFA 220-240 50/60
-> /
MOTOR FAN
TANGENTIAL WITH
BRACKET 220-240
50/60 ->
4022142: MONDIAL



1103858 VENTILAT

ORE TANGENZIALE
DOPPIO 180+180 -20 /
DOUBLE
TANGENTIAL FAN
180 + 180 -20



HETING
ELEMMENT=1101833

1103814 RG000647-

MOTORE PER
MACCHINE A
SCAGLIE
ES50/70/100RPM+CON
DENSAT. /
RG000647-MOTOR
FOR ICE FLAKES
MACHINES ES50 /
70/100 RPM + Capacitor.
926058:
BRICE ITALIA SRL



1103852 MOTORE
1/3 HP /
MOTOR 1/3 HP
1LT116: MIGEL S.R.L.



1103777 MOTORE
1/2 /
MOTOR 1/2 HP
1LT016: MIGEL S.R.L.



1103837 MOTORE
1/4 /
MOTOR 1/4
1LT027: MIGEL S.R.L.



1103880 DRIVEMOT
OR /
DRIVEMOTOR
62031602:
SCOTSMAN ICE SRL



1103649 MOTOR
FAN ICE 406/606/806 /
MOTOR FAN ICE
406/606/806
IOM916108903:
SCOTSMAN ICE
SRL



1103855 MOTORE
0,3HP M63D KW022
4PB14PAM56 D9 240V /
MOTOR 0,3HP M63D
KW022 4PB14PAM56
D9 240V
3001010000:
STAFF ICE SYSTEM
SRL



1103846 MOTORE
SB230 /
MOTOR SB230
3001016000:
STAFF ICE SYSTEM
SRL



1103848 MOTOR
HQD 550 /
MOTOR HQD 550
1200240726:
SCOTSMAN ICE
SRL



1103637 POMPA
COMPLETA
MONTAPANNA /
PUMP
IC129000640:
CARPIGIANI GROUP
- ALI SPA



1103722 MOTOVEN
TILATORE 35W VAX-
150/30 SPECIAL-> /
MOTOR FAN 35W
VAX-150/30 SPECIAL-
>
4121093:
MONDIAL GROUP
S.R.L.



1103785 MOTORID
UTTORE 3 W 230/50/1 /
MOTOR GEAR 3 W
230/50/1
IOM916103101:
SCOTSMAN ICE SRL



1103805 SUPPORTO
VENTILATORE
.EMI8235 CM450 /
FAN SUPPORT
EMI8235 CM450
CM257265130:
CASTEL MAC SPA
CM257265130:
SCOTSMAN ICE SRL

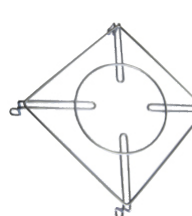

1103900 MOTORID
UTTORE SCOTSMAN /
BIN DRIVE MOTOR
1200267726:
SCOTSMAN ICE SRL





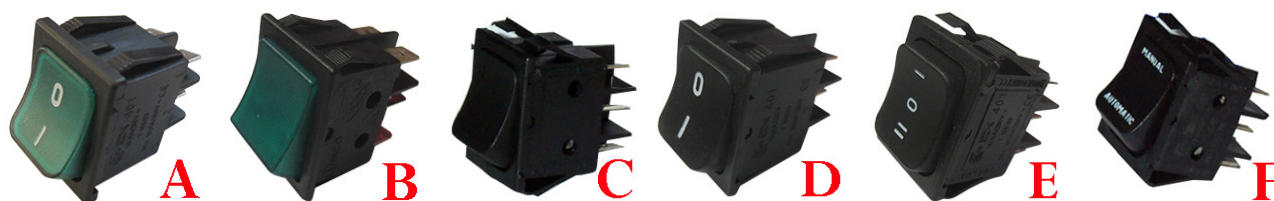

INTERRUTTORI / SWITCHES

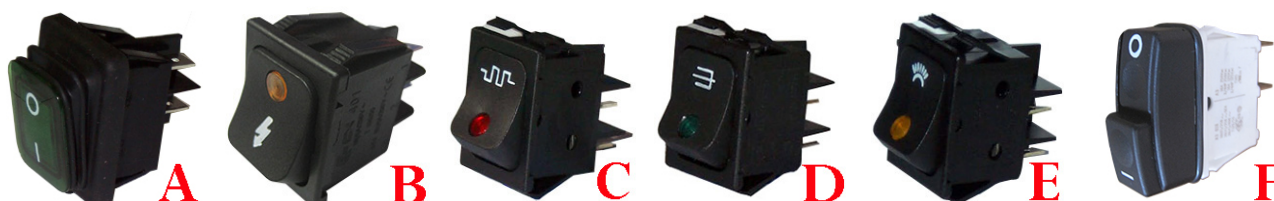

S&P CODE	TYPE	DIMENSIONI DIMENSIONS	POLI POLES	V	COLORE COLOR	S&P CODE	TYPE	DIMENSIONI DIMENSIONS	POLI POLES	V	COLORE COLOR
1105205	C	22X28mm	4	230V	NERO BLACK	1105198	A	22X30mm	4	230V 380V	VERDE GREEN
1105204	C	22X28mm	6	230V	NERO BLACK	1105345	A	22X30mm	5	230V	BLU BLUE
1105224	C	22X28mm	4	230V	BIANCO WHITE	1105045	A	22X30mm	4	230V	NON LUMINOSO NERO BLACK SWITCH NOT LUMINOUS
1105201	F	22X28mm	6	230V	NERO BLACK	1105066	D	13X20mm	4	250V	NERO BLACK
1105008	A	22X30mm	4	230V	VERDE GREEN	1105045	D	22X30mm	4	250V	NERO BLACK
1105007	A	22X30mm	6	230V	VERDE GREEN	1105178	E	22X28mm	6	250V	NERO BLACK
1105006	A	22X30mm	4	230V	ROSSO RED	1105335	B	22X30mm	6	24V	VERDE GREEN
1105044	A	22X30mm	4	230V	ARANCIO ORANGE						



S&P CODE	TYPE	DIMENSIONI DIMENSIONS	POLI POLES	V	COLORE COLOR	S&P CODE	TYPE	DIMENSIONI DIMENSIONS	POLI POLES	V	COLORE COLOR
1105217	A	22X28mm	4	230V	VERDE GREEN	1105200	E	22X28mm	4	230V 380V	ARANCIO ORANGE
1105246	A	22X28mm	4	230V	ARANCIO ORANGE	1105001	B	22X30mm	4	250V	
1105247	A	22X28mm	4	230V	ROSSO RED	1105002	B	22X30mm	4	250V	
1105243	A	22X28mm	4	230V	NERO NON LUMINOSO BLACK SWITCH NOT LUMINOUS	1105003	B	22X30mm	4	250V	
1105196	C	22X28mm	4	230V 380V	ROSSO RED	1105046	B	22X30mm	4	250V	
1105199	D	22X28mm	4	230V 380V	VERDE GREEN	1105405	F	11X27mm	2	250V	NERO BLACK

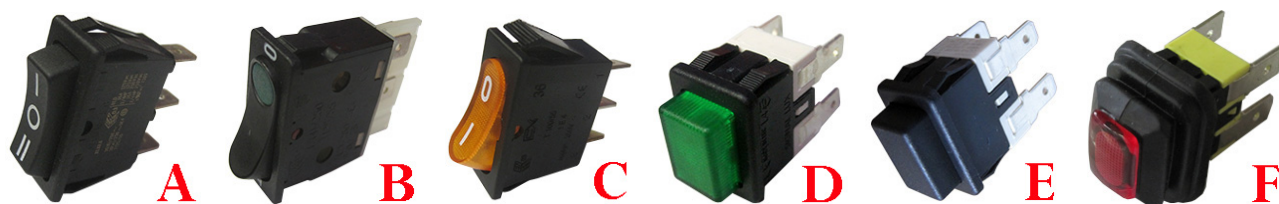

S&P CODE	TYPE	DIMENSIONI DIMENSIONS	POLI POLES	V	COLORE COLOR	S&P CODE	TYPE	DIMENSIONI DIMENSIONS	POLI POLES	V	COLORE COLOR
1105049	A	11X27mm	3	250V	NERO BLACK	1105319	D	13X20mm	4	250V	VERDE GREEN
1105256	B	12X35mm	4	250V	VERDE GREEN	1105239	E	13X20mm	4	250V	NERO BLACK
1105185	C	11X27mm	3	250V	ARANCIO ORANGE	1105324	F	13X20mm	4	250V	VERDE GREEN
1105375	C	11X27mm	3	250V	NERO BLACK	1105328	F	13X20mm	4	250V	ROSSO RED



S&P CODE	TYPE	DIMENSIONI DIMENSIONS	POLI POLES	V	COLORE COLOR	S&P CODE	TYPE	DIMENSIONI DIMENSIONS	POLI POLES	V	COLORE COLOR
1105055	A	13X20mm	4	230 V	INTERRUTTORE ACQUA WATER SWITCH	1105288	D	22X30mm	4	250 V	ROSSO-VERDE RED- GREEN
1105056	A	13X20mm	4	230 V	PULSANTE ACQUA WATER PUSH-BUTTON	1105306	E	22X28mm	6	250 V	BIANCO-NERO WHITE-BLACK
1105057	B	13X20mm	4	230 V	INTER. NERO BLACK SWITCH	1105325	F	21X43mm	2	240 V	VERDE-ROSSO GREEN- RED
1105053	C	22X30mm	4	250 V	LUMINOSO LUMINOUS	1105320	G	34X36mm	6	15V	BIANCO WHITE



S&P CODE	TYPE	DIMENSIONI DIMENSIONS	POLI POLES	V	COLORE COLOR	S&P CODE	TYPE	DIMENSIONI DIMENSIONS	POLI POLES	V	COLORE COLOR
1105033	A	Ø=25mm	4	230V	ROSSO RED	1105343	C	Ø=25mm	4	230V	VERDE GREEN
1105034	A	Ø=25mm	4	230V	ARANCIO ORANGE	1105037	D	CAPPuccio PROTEZIONE RETTANGOLARE RECTANGULAR PROTECTION CAP			
1105035	A	Ø=25mm	4	230V	VERDE GREEN	1105038	E	CAPPuccio PROTEZIONE TONDO ROUND PROTECTION CAP			
1105248	B	Ø=25mm	4	230V	ARANCIO ORANGE	1105337	F	CAPPuccio PROTEZIONE QUADRATO SQUARE PROTECTION CAP			

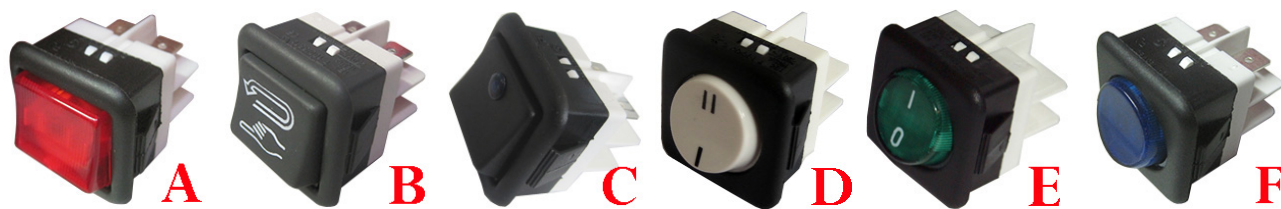

S&P CODE	TYPE	DIMENSIONI DIMENSIONS	POLI POLES	V	COLORE COLOR	S&P CODE	TYPE	DIMENSIONI DIMENSIONS	POLI POLES	V	COLORE COLOR
1105235	A	25X25mm	4	220V	ROSSO RED	1105179	B	25X25mm	6	250V	
1105236	A	25X25mm	4	220V	ARANCIO ORANGE	1105183	B	25X25mm	6	250V	
1105237	A	25X25mm	4	220V	VERDE GREEN	1105357	C	25X25mm	4	250V	BLU BLUE
1105238	A	25X25mm	4	220V	BLU BLUE	1105346	D	25X25mm	2	250V	BIANCO WHITE
1105301	F	25X25mm	4	230V	BLU BLUE	1105347	D	25X25mm	6	250V	BIANCO WHITE
1105166	B	25X25mm	6	250V		1105308	E	25X25mm	4	250V	VERDE GREEN
1105180	B	25X25mm	6	250V							



S&P CODE	TYPE	DIMENSIONI DIMENSIONS	POLI POLES	V	COLORE COLOR	S&P CODE	TYPE	DIMENSIONI DIMENSIONS	POLI POLES	V	COLORE COLOR
1105047	A	22X28mm	4	250V	ARANCIO ORANGE	1105206	D	22X28mm	6	230V 380V	ROSSO RED
1105186	A	22X28mm	4	250V	BIANCO WHITE	1105292	E	22X28mm	4	250V	BIANCO WHITE
1105101	B	22X28mm	5	250V	VERDE GREEN	1105254	F	25X25mm	6	250V	VERDE GREEN
1105050	C	22X28mm	6	250V	ROSSO RED						

1105112 FASTON
FEMMINA 6,3X0,8
SEZ.1-2,5 OTTONE
STAGNATO /
FEMALE FASTON
6,3X0,8X SEZ. 1-2,5
TINNED BRASS



1105113 FASTON
MASCHIO 6,3X0,8
SEZ.1-2,5 OTTONE
STAGNATO /
MALE FASTON
6,3X0,8X SEZ. 1-2,5
TINNED BRASS



1105114 COPRIFAST
ON FEMMINA 6,3X0,8 /
FEMALE
COVERFASTON
6,3X0,8

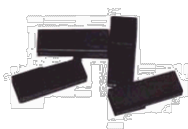

1105115 COPRIFAST
ON MASCHIO 6,3X0,8 /
MALE COVERFASTON
6,3X0,8

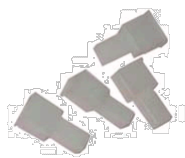

1105407 FASTON
FEMMINA
PREISOLATO
RINFORZATO 6,3X0,8
SEZIONE 2,5 OTTONE
STAGNATO /
PRE-INSULATING
REINFORCED FEMALE
FASTON 6,3x0,8
SECTION 2.5 TINNED
BRASS

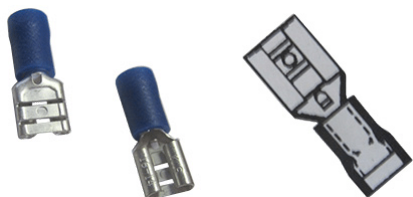

1105408 FASTON
MASCHIO
PREISOLATO
RINFORZATO 6,3X0,8
SEZIONE 2,5 OTTONE
STAGNATO /
MALE FASTON 6,3x0,8
REINFORCED PRE-
INSULATING SECTION
2.5 TINNED BRASS

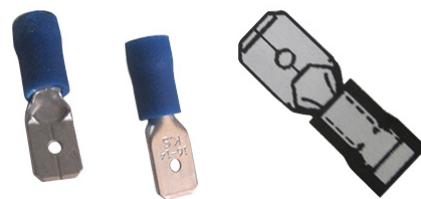

1105409 FASTON
FEMMINA
TOTALMENTE
RINFORZATO
PREISOLATO 6,3X0,8
SEZ.2,5 OTTONE
STAGNATO /
FASTON FEMALE
FULLY REINFORCED
PRE-INSULATING
6,3x0,8 SEZ.2,5 TINNED
BRASS



1105410 CAPOCORD
A A FORCELLA
PREISOLATO 8,1X0,8
FORO 5,3 SEZIONE 2,5 /
TERMINALS FORK
PRE-INSULATING
8,1X0,8 HOLE SECTION
5.3 2.5



TERMOSTATI EVAPORATORE / EVAPORATOR THERMOSTATS



L

RICOPERTO-COVERED

CODICE S&P S&P CODE	TEMPERATURA °C TEMPERATURE °C	N. POLI N.POLES	SCHEDA TECNICA DATA SHEET	REF	ADATTABILITA' ADAPTABILITY
1106002	-22°C / -3°C	3	L=2300mm	K22 L1082	926081:BRICE RFS0B893:EURFRIGOR 087969: ELECTROLUX M0611020: LUXIA 68023004:RANCILIO K59P6839: BREMA 6711020: N.T.F.
1106417		3	L=2250mm	K22 S1094	R23896: BREMA
1106754	-22°C / -3°C	4	L=2100mm	K61 L1502	

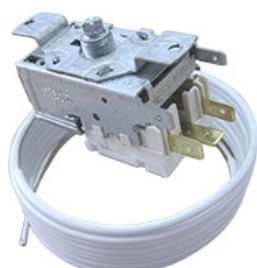

L

RICOPERTO-COVERED

CODICE S&P S&P CODE	TEMPERATURA °C TEMPERATURE °C	N. POLI N.POLES	SCHEDA TECNICA DATA SHEET	REF	ADATTABILITA' ADAPTABILITY
1106136	-20°C / -6°C ±2	3	L=2250mm	K22 L1083	R23597: BREMA
1106750		3	L=1500mm	K22 S1098	4513: I.T.V. S.A



L

RICOPERTO-COVERED

CODICE S&P S&P CODE	TEMPERATURA °C TEMPERATURE °C	N. POLI N.POLES	SCHEDA TECNICA DATA SHEET	REF	ADATTABILITA' ADAPTABILITY
1106284	-18°C / -8°C	4	L=1800mm	K61 L1508	ACM55 R12: SCOTSMAN NM62026416: CASTEL MAC I62026416: GIGA
1106202	-22°C / -11,5°C	4	L=1800mm	K61 L1504	62026411: SCOTSMAN



RICOPERTO-COVERED

CODICE S&P S&P CODE	TEMPERATURA °C TEMPERATURE °C	N. POLI N.POLES	SCHEDA TECNICA DATA SHEET	REF	ADATTABILITA' ADAPTABILITY
1106391	-3,6° C / +12°C		A=Ø11,5X27mm L=1000mm	K55 L5112	



NON RICOPERTO-NOT COVERED

CODICE S&P S&P CODE	TEMPERATURA °C TEMPERATURE °C	N. POLI N.POLES	SCHEDA TECNICA DATA SHEET	REF	ADATTABILITA' ADAPTABILITY
1106372		3	L=2000mm	K59 L1045	1LT019: MIGEL



NON RICOPERTO-NOT COVERED

CODICE S&P S&P CODE	TEMPERATURA °C TEMPERATURE °C	N. POLI N.POLES	SCHEDA TECNICA DATA SHEET	REF	ADATTABILITA' ADAPTABILITY
1106094	-24°C / -14°C	2	L=2000mm	K50 L3163	926077*: BRICE R23034: BREMA



NON RICOPERTO-NOT COVERED

CODICE S&P S&P CODE	TEMPERATURA °C TEMPERATURE °C	N. POLI N.POLES	SCHEDA TECNICA DATA SHEET	REF	ADATTABILITA' ADAPTABILITY
1106024	-18°C / -8°C	4	L=1800mm	K61 L1501	62026400: SCOTSMAN 4007015000: STAFF ICE SYSTEM
1106156	-34°C / -15°C	3	L=2000mm	077B0034	CM19797011: SCOTSMAN 19797011/0: CASTEL MAC



L

NON RICOPERTO-NOT COVERED

CODICE S&P S&P CODE	TEMPERATURA °C TEMPERATURE °C	N. POLI N.POLES	SCHEDA TECNICA DATA SHEET	REF	ADATTABILITA' ADAPTABILITY
1106209	-15°C / -1°C	3	L=1200mm	K22 L1031	100153: I.T.V. S.A



L

NON RICOPERTO-NOT COVERED

CODICE S&P S&P CODE	TEMPERATURA °C TEMPERATURE °C	N. POLI N.POLES	SCHEDA TECNICA DATA SHEET	REF	ADATTABILITA' ADAPTABILITY
1106328		3	L=2000mm	K22 L2082	1LT112: MIGEL
1106011	-13°C / -4°C	3	L=2000mm	K22 L2030	62026414:SCOTSMAN 1LT092: MIGEL Z1EL011: SIMAG
1106064	-16°C / -2°C	3	L=2000mm	K22 L2021	
1106039	-19°C:-10°C / -5°C	3	L=2000mm	K22 L2022	62026413:SCOTSMAN 62026413: SIMAG
1106333	-2°C / +3°C	3	L=1600mm	K22 L2069	RF000618:BRICE RF000618:EURFRIGOR RF000618:EURFRIGOR



L

NON RICOPERTO-NOT COVERED

CODICE S&P S&P CODE	TEMPERATURA °C TEMPERATURE °C	N. POLI N.POLES	SCHEDA TECNICA DATA SHEET	REF	ADATTABILITA' ADAPTABILITY
1106091	-5°C / +8,5°C	2	L=2000mm	K55 L5027	081689:ELECTROLUX



L

NON RICOPERTO-NOT COVERED

CODICE S&P S&P CODE	TEMPERATURA °C TEMPERATURE °C	N. POLI N.POLES	SCHEDA TECNICA DATA SHEET	REF	ADATTABILITA' ADAPTABILITY
1106207	+1°C:+4,5°C / +11°C	3	L=1500mm	K22 L2084	



L

A



NON RICOPERTO-NOT COVERED

CODICE S&P S&P CODE	TEMPERATURA °C TEMPERATURE °C	N. POLI N.POLES	SCHEDA TECNICA DATA SHEET	REF	ADATTABILITA' ADAPTABILITY
1106215	-20,5°C / -1°C	3	A=Ø8,7X35,6mm L=1950mm	K22 L1020	62020100:SCOTSMAN
1106144	-26,5°C / -19,5°C	2	A=Ø8,8X33,1mm L=1500mm	K22 L3020	63003800:SCOTSMAN
1106206	-19,5°C / -1°C	3	A=Ø8,8X37,7mm L=1450mm	K22 L1074/001	62020101:SCOTSMAN
1106127	-14°C / -9°C	2	A=Ø8,9X37mm L=1500mm	K22 L3021	62012500:SCOTSMAN
1106250	-14,5°C / -1°C	2	A=Ø5X38mm L=2000mm	K22 L3022	62012900:SCOTSMAN

TERMOSTATI CONTENITORE / CONTAINER THERMOSTATS



L



RICOPERTO-COVERED

CODICE S&P S&P CODE	TEMPERATURA °C TEMPERATURE °C	N. POLI N.POLES	SCHEDA TECNICA DATA SHEET	REF	ADATTABILITA' ADAPTABILITY
1106703	+1,5°C / +11°C	2	L=2000mm	K50 S3493	MA2523400 :MARENO 274:IT.V. S.A. 083520:ELECTROLUX



L



NON RICOPERTO-NOT COVERED

CODICE S&P S&P CODE	TEMPERATURA °C TEMPERATURE °C	N. POLI N.POLES	SCHEDA TECNICA DATA SHEET	REF	ADATTABILITA' ADAPTABILITY
1106147	+1°C / +3°C	2	L=1500mm	K50 L3383	RFS0B892:EURFRIGOR RFS0B892:EURFRIGOR
1106208	+1°C / +3°C	3	L=1550mm		RF000615:EURFRIGOR 926079:BRICE RF000615:EURFRIGOR
1106115	+1,5°C / +11°C	2	L=2000mm	K50 L3006	SD125: SIMAG 62020900EX:SCOTSMAN



L



NON RICOPERTO-NOT COVERED

CODICE S&P S&P CODE	TEMPERATURA °C TEMPERATURE °C	N. POLI N.POLES	SCHEDA TECNICA DATA SHEET	REF	ADATTABILITA' ADAPTABILITY
1106003	+1°C / +3°C	2	L=1450mm	K50 L3383	085283: ELECTROLUX 1106003: N.T.F. 23005: BREMA 68023005: RANCILIO 1106003: MBM
1106281		2	L=3000mm	K50 L3274	C150: BREMA NR23421: N.T.F. 926098: BRICE
1106278	+1,5°C: +4°C / +11°C	2	L=2000mm	K50 L3324	CM19797026: SCOTSMAN 197970260: CASTEL MAC
1106693	+1°C / +3°C	2	L=1500mm	K50 L3383	K00079: ARISTARCO
1106721	+2,5°C: +6°C / +12,5°C	2	L=1300mm	K50 L3295	0KD779: ELECTROLUX CS0003824910: SCOTSMAN



L



NON RICOPERTO-NOT COVERED

CODICE S&P S&P CODE	TEMPERATURA °C TEMPERATURE °C	N. POLI N.POLES	SCHEDA TECNICA DATA SHEET	REF	ADATTABILITA' ADAPTABILITY
1106690	+1,5°C: +4° / +11°C	2	L=1200mm	K50 L3231/002	
1106742	+1,5°C / +11°C	2	L=1200mm	K50 S3485	



L

A



NON RICOPERTO-NOT COVERED

CODICE S&P S&P CODE	TEMPERATURA °C TEMPERATURE °C	N. POLI N.POLES	SCHEDA TECNICA DATA SHEET	REF	ADATTABILITA' ADAPTABILITY
1106009	+1,7°C / +9,5°C	2	A=Ø10X100mm L=1500mm	K55 L1042	62026302: SCOTSMAN ILT020: MIGEL ZIELO10: SIMAG



L

A



NON RICOPERTO-NOT COVERED

CODICE S&P S&P CODE	TEMPERATURA °C TEMPERATURE °C	N. POLI N.POLES	SCHEDA TECNICA DATA SHEET	REF	ADATTABILITA' ADAPTABILITY
1106722		2	A=Ø8,4X79mm L=2750mm	K50 S3544	



L

A



NON RICOPERTO-NOT COVERED

CODICE S&P S&P CODE	TEMPERATURA °C TEMPERATURE °C	N. POLI N.POLES	SCHEDA TECNICA DATA SHEET	REF	ADATTABILITA' ADAPTABILITY
1106251	+1,7°C DIFF.3° / +9,5°C	3	A=Ø9,5X103mm L=2000mm	K22 L1075	62026303:SCOTSMAN



L

A



NON RICOPERTO-NOT COVERED

CODICE S&P S&P CODE	TEMPERATURA °C TEMPERATURE °C	N. POLI N.POLES	SCHEDA TECNICA DATA SHEET	REF	ADATTABILITA' ADAPTABILITY
1106097		3	A=Ø6,5X110mm L=900mm	K36 L7259	62026301:SCOTSMAN
1106019		2	A=Ø10X100mm L=1200mm	K55 L5081	19797017/0:CASTEL MAC CM19797017:SCOTSMAN
1106028		2	A=Ø10X100mm L=1100mm	K55 L5082	CM19797018:SCOTSMAN 19797018/0:CASTEL MAC

TERMOSTATI CONDENSATORE / CONDENSER THERMOSTATS



NON RICOPERTO-NOT COVERED

CODICE S&P S&P CODE	TEMPERATURA °C TEMPERATURE °C	N. POLI N.POLES	SCHEDA TECNICA DATA SHEET	REF	ADATTABILITA' ADAPTABILITY
1106344		3	A=Ø10X100mm B=1500mm	K22 L1529	19797025/0:CASTEL MAC CM19797025:SCOTSMAN

TERMOSTATI SICUREZZA / SAFETY THERMOSTATS



NON RICOPERTO-NOT COVERED

CODICE S&P S&P CODE	TEMPERATURA °C TEMPERATURE °C	N. POLI N.POLES	SCHEDA TECNICA DATA SHEET	REF	ADATTABILITA' ADAPTABILITY
1106297		3	L=1500mm	K22 L1069	R23447: BREMA



RICOPERTO-COVERED

CODICE S&P S&P CODE	TEMPERATURA °C TEMPERATURE °C	N. POLI N.POLES	SCHEDA TECNICA DATA SHEET	REF	ADATTABILITA' ADAPTABILITY
1106737		2	L=2500mm	077B1118	1101029: MONDIAL



L



NON RICOPERTO-NOT COVERED

CODICE S&P S&P CODE	TEMPERATURA °C TEMPERATURE °C	N. POLI N.POLES	SCHEDA TECNICA DATA SHEET	REF	ADATTABILITA' ADAPTABILITY
1106158		3	L=1850mm	077B0070 L3241	197970012/0:CASTEL MAC
1106718		2	L=900mm	K50 L3212	2108700001:UGOLINI



L

A



NON RICOPERTO-NOT COVERED

CODICE S&P S&P CODE	TEMPERATURA °C TEMPERATURE °C	N. POLI N.POLES	SCHEDA TECNICA DATA SHEET	REF	ADATTABILITA' ADAPTABILITY
1106458		2	A=Ø10X56mm L=1080mm	K50 L3388	1101028:MONDIAL
1106462		3	A=Ø9X37mm L=1400mm	K50 L3417	1101043:MONDIAL



L

A



RICOPERTO-COVERED

CODICE S&P S&P CODE	TEMPERATURA °C TEMPERATURE °C	N. POLI N.POLES	SCHEDA TECNICA DATA SHEET	REF	ADATTABILITA' ADAPTABILITY
1106705		2	A=Ø7,15X15mm L=750mm	K50 L3212	3380008300:UGOLINI



L



NON RICOPERTO-NOT COVERED

CODICE S&P S&P CODE	TEMPERATURA °C TEMPERATURE °C	N. POLI N. POLES	SCHEDA TECNICA DATA SHEET	REF	ADATTABILITA' ADAPTABILITY
1106203			L=2500mm	K55 P5851	



L1

A



L2



RICOPERTO-COVERED

CODICE S&P S&P CODE	TEMPERATURA °C TEMPERATURE °C	N. POLI N. POLES	SCHEDA TECNICA DATA SHEET	REF	ADATTABILITA' ADAPTABILITY
1106759	-6,4°C/+8,5°C // -6,0°C/+8,8°C	2	L1=1800mm A=Ø11X30mm / L2=2000mm	K52 L4512	

KIT TERMOSTATO DANFOSS/ THERMOSTATS KIT DANFOSS



L



NON RICOPERTO-NOT COVERED

CODICE S&P S&P CODE	TEMPERATURA °C TEMPERATURE °C	N. POLI N. POLES	SCHEDA TECNICA DATA SHEET	REF	ADATTABILITA' ADAPTABILITY
1106098	-25°:-13,5°C // +2,5°:-5,5°C	3	L=1300mm	077B7001	
1106099	-21°:-11,5°C // 0°:-7,5°C	4	L=1300mm	077B7002	
1106100	-27,5°:+3,5°C // +3,5°:-11°C	4	L=1600mm	077B7003	
1106101	-28°C / -10°C	4	L=2300mm	0777B7006	

1106053 TERMOST
ATO -35/+35 F/2000
MONOFASE -
SENSORE Ø
6,5X115mm
CAPILLARE 1500mm /
THERMOSTAT -
35/+35 F/200 SINGLE
PHASE -SENSOR Ø
6,5X115mm
CAPILLARY 1500mm
80583002:
IRF- C&D-
FIOCCHETTI

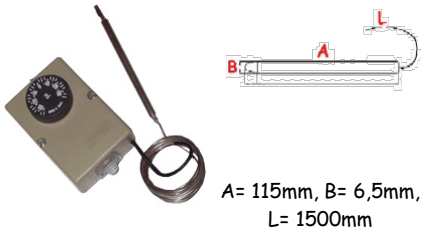

1106326 KIT
TERMOSTATO
AUSILIARIO /
THERMOSTAT KIT
CM814533480:
CASTEL MAC SPA
CM81453348:
SCOTSMAN ICE
SRL



1106484 TERMOME
TRO D.52 +40/-40 /
THERMOMETER D.52
+40 / -40



1106472 TERMOME
TRO CIRCOLARE
D.52 mm CPNF -40+40
/
D.52 ROUND
THERMOMETER -40
+40 mm CPNF



1106210 TELETER
MOMETRO -40+40
D.60 CF72 /
THERMOMETER-
40+40 D.60 CF72

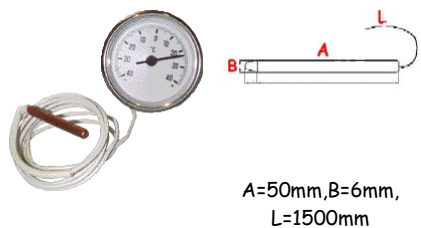

1106061 TERMOME
TRO DIG. FISS. CLIPS
DTE+ SCATOLA--
50+70°C /
CLIPS FASTENER
DIGITAL
THERMOMETER DTE
1188017:
MONDIAL GROUP
S.R.L.



1106077 TERMOME
TRO PER FREEZER -
50+70 /
REFRIGERATOR
THERMOMETER -
50+70



1106025 TERMOME
TRO DIGITALE -
50+260° /
DIGITAL
THERMOMETER
50+260°



1106204 TERMOME
TRO PER FORNO /
THERMOSTAT FOR
OVEN



1106466 TERMOIG
ROMETRO
ELETTRONICO CON
MIN/MAX /
THERMOIGROMETER



1106467 TERMOIG
ROMETRO CON
SONDA
INTERNO/ESTERNO /
THERMOIGROMETER
WITH
INTERNAL/EXTERNAL
L PROBE



1106218 TERMOME
TRO DIGITALE CON
SONDA FISSA -50+150
/
DIGITAL
THERMOMETRE
WITH FIXED PROBE -
50+150



1106318 TERMOME
TRO DIGITALE CON
SONDA FISSA -
50°C+300°C /
DIGITAL
THERMOMETER
WITH FIXED PROBE -
50°C+300°C



1106131 TERMOME
TRO INFRAROSSI -
18+400° /
INFRA-RED
THERMOMETER -
18+260°



1106075 TERMOME
TRO ABS -40+40 /
ALCOHOL MOPLN
THERMOMETER -
40+40



1106076 TERMOME
TRO MOPLN -50+50 /
ALCOHOL ABS
THERMOMETER -
40+40



1106063 TERMOST
ATO IC 901 NTC 16A
12V /
THERMOSTAT IC
NTC 16A 12V



1106068 TERMOST
ATO ID 961 NTC 16A
12V /
THERMOSTAT ID 961
NTC 16A 12V



1106226 TERMOST
ATO ID 961 NTC 230V
15A /
DIGITAL
THERMOSTAT ID 961
NTC 230V 15A



= 1129176

1106435 TERMOST
ATO ELIWELL
EWPLUS 961 230V
NTC /
ELIWELL
THERMOSTAT EW961
PLUS 230V NTC



1106685 CONTROL
LER ARMADI 1X
PTC/NTC 230V 1 RELE
/
CONTROLLER
CABINET FRIDGE 1
BORE PTC / NTC 230V
1 RELAY



1106083 TERMOST
ATO IS972 LX NTC
30mm TTL /
THERMOSTAT IS972
LX NTC 30mm TTL



1106069 TERMOME
TRO 974/C PTC 12V 2
SONDE /
THERMOMETER
974/C PTC 12V WITH
2 BORES



1106449 STRUMEN
TO ELIWELL 974
LX230 /
ELIWELL 974 LX230



1106310 TERMOST
ATO DIGITALE
ELIWELL ID 974 PLUS
230V NTC-PTC /
DIGITAL
THERMOSTAT
ELIWELL ID 974 230V
8A



1106686 CONTROL
LER ARMADI 2
SONDE PTC/NTC
230V 3RELE' 16A /
CONTROLLER
CABINET
REFRIGERATOR 2
PROBES PTC / NTC
230V 3RELE '16A



1106688 "TERMOR
EGOLATORE;
EWPX174/L -4 C" /
"THERMOREGOLATO
R; EWPX174 / L -4 C"

087161EX:
ELECTROLUX
085975EX:
ELECTROLUX
089904EX:
ELECTROLUX
0S0788:ELECTROLU
X



1106365 TERMOME
TRO DIGITALE /
DIGITAL
THERMOMETER
32Z8250:
ANGELO PO
GRANDI CUCINE
SPA
TR0402:
SILANOS SRL



1106240 TERMOST
ATO DIGITALE 0-250°
230V SENZA SONDA
IC912 /
DIGITAL
THERMOSTAT 0-250°
230V WITHOUT
PROBE
GV: CB SRL



1106241 TERMOST
ATO DIGITALE 0-99°
230V SENZA SONDA /
DIGITAL
THERMOSTAT 0-99°
230V WITHOUT
PROBE

VR-EV-ESP/2: CB
SRL



1106701 "TERMOR
EGOLATORE; IR33" /

THERMOREGOLATO
R; IR33

092355:

ELECTROLUX
PROFESSIONAL
S.P.A.



1106402 TERM.DIG
IT.AT2-5BS4E-1DX
VDI 025057-00R /
DIGITAL
THERMOSTAT AT2-
5BS4E-1DX VDI
025057-00R

02505700R:

ELETTROBAR
DIVISIONE DELLA
EUROTEC SRL



1106438 TERMOST
ATO DIGITALE 1
USC. 12V /
DIGITAL
THERMOSTAT 1
OUTLET 12V

22192009:

ELFRAMO SPA
22192005EX:
ELFRAMO SPA



1106400 SBRINATO
RE COMPATTO LD1-
15BE-AG /
DEFROSTER LD1-
15BEAG

*:

MBM- EUROTEC SRL
- DIV. COOKING
SERVICE

02338100R:

ELETTROBAR
DIVISIONE DELLA
EUROTEC SRL



1106413 REGOLAT
ORE LD2 15 B4E /
DIGITAL
THERMOSTAT LD2 15
B4E

023382-00:

MBM- EUROTEC SRL
- DIV. COOKING
SERVICE



1106428 TERM.IC
912 TCJ
230V.PR.SP.OEM /
THERMOSTAT IC 912
TCJ 230V.PR.SP.OEM

ED07700:

OEM ALI SPA



1106349 TERMORE
GOLATORE ELIWELL
IC912 /
THERMOSTAT
ELIWELL IC912



1106752 "TERMOM
ETRO DIGITALE;
EVK401N7VHXXX01"
/

DIGITAL
THERMOMETER
EVK401N7VHXXX01

OPE301:

ELECTROLUX
PROFESSIONAL
S.P.A.



1106482 STRUMEN
TO DIXELL X
GN2100BV XR60C /
CONTROLS UNIT
DIXELL X GN2100BV
XR60C

RC0883:

FORCAR S.R.L.



1106395 TERMOST
ATO GRANITORE
GBG /
THERMOSTAT FOR
GRAINER GBG

SL310002718:

GBG ALI SPA



1106751 TELETER
MOSTATO
PIEJCOP000 230/50 +
CORNICE /
CONTROLLER
PIEJCOP000 230/50 +
FRAME

R34986: ILSA SPA



1106448 TERMOST
ATO
EVKB23N7PXXSX01 /
THERMOSTAT
EVKB23N7PXXSX01

BN1681450:

POLARIS/BARON
ALI S.P.A.



1106455 TERMOST
ATO DIGITALE AKO
D140123 - 230V /
DIGITAL
THERMOSTAT AKO
D140123-230V



1106476 CONTROL
LORE DANFOSS
MOD. AKCC-210
(cod.084B8520) /
DANFOSS
CONTROLLER MOD.
AKCC-210



1106353 TERMORE
GOLA.ON-OFF
EV7401J7E00002 /
THERMOREGOLATO
R ON-OFF
EV7401J7E00002
**6011125: GIORIK
SPA**



1106696 CONTROL
LORE DI
TEMPERATURA A 1
GRADINO,
ALIMENTAZIONE
24/230 VAC INGRESSI
ANALOGICI1 per J/K
relè 1 da 8 A res. @ 250
VAC CON BUZZER /
TEMPERATURE
CONTROLLER TO 1
STEP, POWER 24/230
VAC INPUT
ANALOGICI1 J / K
relay 1 8 res. @ 250
VAC WITH BUZZER



INCASSO=90X90mm,
DIMENSIONI=96X9
6X67Hmm

1106380 TERMOST
ATO DIXEL XW60L /
THERMOSTAT DIXEL
XW60L



BN16815100:
LAINOX ALI SPA
BN16815100:
SILKO ALI SPA

1106741 SBRINATO
RE COMPATTO
LCD32Q4E-AS /
DEFROSTER
LCD32Q4E
COMPACT-AS
02122600R:
MBM- EUROTEC SRL
**- DIV. COOKING
SERVICE**



1106477 CONTROL
LORE ELETTRONICO
PER UNITA'
REFRIGERANTI
IWC730 SLIM 230V /
ELECTRONIC
CONTROLLER FOR
UNIT 'COOLANTS
IWC730 SLIM 230



1106687 CONTROL
LORE ELETTRONICO
IWC 720
COMPRESSORE
SBRINAMENTO 230V
/
DIGITAL
CONTROLLER
IWC720
COMPRESSOR
DEFROST 230V



1106469 CONTROL
LORE NTC IWC 750 /
CONTROLLER
IWC750 NTC



1106418 CONTROL
LORE XW20L 230V
NTC /
DIGITAL
THERMOSTAT
XW20L 230V NTC



1106423 IGROMET
RO IC 915/R 84X2
230V UMIDITA' /
HYGROMETER IC
915/R 84X2 230V



= 1129215

1106453 TERMOST
ATO VISUALIZZATO
GUIDA DIN, 1 PUNTO
DI INTERVENTO
230V /
DIGITAL
THERMOSTAT 230V



1106396 TERMOST
ATO
CONDENSATORE W
K36 L729 /
CONDENSER
THERMOSTAT W K36
L729
**1LT021: MIGEL
S.R.L.**



1106130 TERMOST
ATO SICUREZZA
CONDENSATORE /
CAPACITOR SAFETY
THERMOSTAT

NC23114: N.T.F. SRL
C23114:

BREMA ICE MAKERS
SPA

085286:

ELECTROLUX
PROFESSIONAL
S.P.A.



1106465 RF00B537-
TERMOSTATO
BIMETALLICO
TY60/A-H231* /
RF00B537-
THERMOSTAT
BIMETALLIC TY60/A-
H231 *

926078ex:

BRICE ITALIA SRL

926121:

BRICE ITALIA SRL



1106753 THERM.HI
GH TEMP 3/8 CUBER /
THERM.HIGH TEMP
3/8 CUBER

IOM904108703:

SCOTSMAN ICE
SRL



1106280 CORPO VT
TES2 R404A
CAMPON(-
40+10)MOP+15
(68Z3405) /
THERMOSTAT R404A

CM19200002/0:

CASTEL MAC SPA



1106291 TEMPERA
TURE SENSOR /
TEMPERATURE
SENSOR

1100054521:

SCOTSMAN ICE
SRL



1107066 KIT
VALVOLA
GALLEGGIANTE
MUSTER BREMA /
MICRO-SWITCH
FLOATER MUSTER
BREMA

C10188:

BREMA ICE
MAKERS SPA



1124133 VALVOLA
GALLEGGIANTE /
FLOATER VALVE

10188:

BREMA ICE
MAKERS SPA



4122014 Piastrina
premicro /
Micro plate press

22359:

BREMA ICE
MAKERS SPA



1107009 MICRO
GALLEGG.
EURFRIGOR T.N. /
MICRO-SWITCH
FLOATER

EURFRIGOR

A5928040:

BRICE ITALIA SRL

RI00A241+RH00067

: EURFRIGOR ICE

1107009: EURO

2000

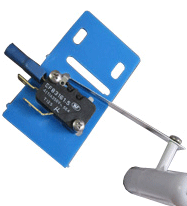

4114627 GALLEGG
IANTE SINGOLO N
CUBETTO /
FLOAT

910056:

BRICE ITALIA SRL

RH000679:

EURFRIGOR

601041:

KASTEL SRL



4114889 RH001070-
STAFFA ABS
SUPPORTO MICRO
GALLEGGIANTE /
RH001070-MICRO
FLOATING SUPPORT
BRACKET ABS

910085:

BRICE ITALIA SRL

RH001070:

EURFRIGOR SRL



1107001 MICRO
GALLEGGIANTE
CASTELMAC /
MICRO-SWITCH
FLOATER ICEMATIC

81409179/0: VEGA

CM81409179/0:

CASTEL MAC SPA

CM81449091:

SCOTSMAN ICE

CM81409179:

SCOTSMAN ICE

881409179:

GRUPPO CIMBALI

CM81409179:

SIMAG SPA



1107051 MICRO
GALLEGGIANTE ITV
COMPLETO /
COMPLETE MICRO-
SWITCH FLOATER
ITV

105058: I.T.V. S.A.



1107196 GALLEGGIANTE COMPLETO KP / COMPLETE MICRO-SWITCH FLOATER MIGEL

2SLO01: MIGEL S.R.L.



1124229 VALVE ASSY (RESERVOIR) / VALVE ASSY (RESERVOIR)

0200221702:
SCOTSMAN DIV.
FRIMONT SPA
19864011/0:
CASTEL MAC SPA



1124262 FLOAT VALVE / FLOAT VALVE

IOM913111101:
SCOTSMAN DIV.
FRIMONT SPA



4114339 FLOAT / FLOAT

0200334101:
SCOTSMAN DIV.
FRIMONT SPA



4114418 FLOAT BAR / FLOAT BAR

0200338303:
SCOTSMAN DIV.
FRIMONT SPA
0200338303:
SIMAG SPA



4114149 VALVOLA GALLEGGIANTE SCOTSMAN / FLOAT SCOTSMAN

CF66058500:
CASTEL MAC SPA
66058500:
SCOTSMAN



4114454 VALVOLA GALLEGGIANTE / FLOAT VALVE

66058501:
SCOTSMAN DIV.
FRIMONT SPA



1107033 MICRO GALLEGGIANTE COSMETAL / MICRO-SWITCH FLOATER COSMETAL

3822902: VEGA
CM81300027/0:
CASTEL MAC SPA
CM3822902*:
CASTEL MAC SPA
3822902:
COSMETAL SRL



1107231 ASSIEME SUPPORTO 2 MICRO X IMF28-35-58 NEW / ASSY SUPPORT 2 MICRO X IMF 28-35-58 NEW

IMF28-35-58 NEW:
BREMA ICE
MAKERS SPA

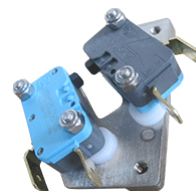

1107233 RH003800 ASSIEME MICRO IMPULSI PALETTE E / RH003800 PULSE MICROSWITCH F83.161.3 10A 230V

AS928041:
BRICE ITALIA SRL

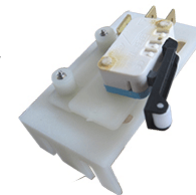

1107063 MICRO IMPULSI 83161.1 + STAFFA COMPLETO / MICRO-SWITCH 83161.1

RH003800:
BRICE ITALIA SRL
RH003800:
EURFRIGOR ICE
MAKERS SRL
AS928041:
BRICE ITALIA SRL

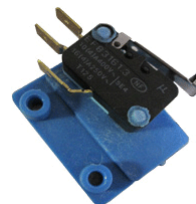

1107007 MICRO INTERR.OMRON OMOL.VDE / MICRO-SWITCH OMRON OMOL.VDE

CM19410209/0:
CASTEL MAC SPA
CM19410209:
SCOTSMAN ICE
SRL

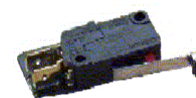

1107010 MICROINT
ERR. OMRON
V1661CR5 /
MICRO-SWITCH
FLOATER OMRON
V1661CR5

819410208:
GRUPPO CIMBALI
SPA
CM19410208/0:
CASTEL MAC SPA
CM19410208:
SCOTSMAN ICE
SRL
CM19410208:
SIMAG SPA



1107011 MICROZ15
GW22B34050 /
MICRO-SWITCH Z15
GW22B34050

CM19410300/0:
CASTEL MAC SPA
CM19410300:
SCOTSMAN ICE
SRL

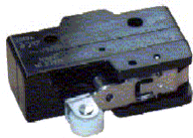

1107138 MICRO A
ROTELLA CON LEVA
LUNGA /
ROLLER MICRO-
SWITCH
100387: I.T.V. S.A.



1107236 MICROINT
ERRUTTORE
COMPLETO KP /
COMPLETE MICRO-
SWITCH KP

2LT003: MIGEL
S.R.L.



1105416 SWITCH
LIMIT SPDT /
SWITCH LIMIT SPDT

IOM910116001:
SCOTSMAN ICE
SRL



1107086 KIT
LIVELLOSTATO /
MICRO SWITCH
LEVEL KIT

9090611000:
STAFF ICE SYSTEM
SRL
3010024000:
STAFF ICE SYSTEM
SRL



1105060 INTERRUT
TORE DI
PROSSIMITA' /
PROXIMITY SWITCH
23540:

BREMA ICE
MAKERS SPA



1105387 SWITCH
FAN CYCLE /
SWITCH FAN CYCLE

IOM904109601:
SCOTSMAN DIV.
FRIMONT SPA

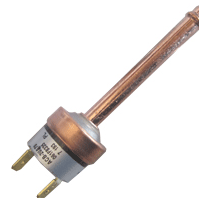

1107146 DRIP
TRAY / DRIP TRAY
CF65068600:

CASTEL MAC SPA
65068600:
SCOTSMAN DIV.
FRIMONT SPA



1107147 WATER
DRIP TRAY /
WATER DRIP TRAY
66075600:

SCOTSMAN DIV.
FRIMONT SPA



4114947 CURTAIN
SWITCH /
CURTAIN SWITCH
1100056303:

SCOTSMAN DIV.
FRIMONT SPA



4122221 WATER
LEVEL SENSOR /
WATER LEVEL
SENSOR
1200276021:

SCOTSMAN DIV.
FRIMONT SPA



1107214 CURTAIN
SWITCH /
CURTAIN SWITCH
1100056304:

SCOTSMAN DIV.
FRIMONT SPA



1107191 MAGNET /
MAGNET
1100056302:

SCOTSMAN ICE
SRL
*: CASTEL MAC SPA



1107149 MAGNETE

/
MAGNET
CM19355004/0:
CASTEL MAC SPA
CM19355004:
SCOTSMAN ICE
SRL



1107167 MAGNETE

PER
MICROINTERRUTTO
RE CAPP /
MICRO-SWITCH
MAGNET
927088:
ELETTROBAR
DIVISIONE DELLA
EUROTEC SRL



1107130 MAGNETE

8X16X40 +
CUST.XDEM201 /
MAGNET 8X16X40 +
COVER.XDEM201
926014:
ELETTROBAR
*:
MBM- EUROTEC SRL
- DIV. COOKING
SERVICE



1107141 MAGNETE

STEM M303 N CDC
GE 32 /
MAGNET STEM M303
N CDC GE 32
0800142:
LAMBER DI AFFABA
FRANCESCO & C.
CM19355007:
SIMAG SPA
CM19355007:
SCOTSMAN ICE
SRL
CM19355007/0:
CASTEL MAC SPA



=1107142

1107213 MAGNET /

MAGNET
1100056305:
SCOTSMAN ICE
SRL



1107079 MAGNETE

SAP-P100 /
MAGNET
9131447*:
GRUPPO CIMBALI
SPA
986034000:
GRUPPO CIMBALI
SPA



1107004 MAGNETE

X REED SILANOS /
REED MAGNET
SILANOS
986034000:
GRUPPO CIMBALI
SPA
H32969:
COMENDA ALI SPA
411010:
COMENDA ALI SPA
903651: SILANOS
SRL
049627:
ELECTROLUX
32969:
HOONVED - ALI
SPA
9131447:
GRUPPO CIMBALI
SPA



1107127 MAGNETE

IN NEODIMIO
40X14X3,8mm /
MAGNET
40X14X3,8mm
KRUPPS S.R.L.



1107170 MAGNETE

PORTA
MICROINTERRUTTO
RE - MICROSWITCH /
MICROSWITCH
MAGNET
1225: KRUPPS S.R.L.



1107219 MAGNETE

8X16X40 ArQ11-B2.
M370 AP /
MAGNET 8X16X40
Art. M370 AP
BN161803:
OLIS DIVISIONE
DI ALI GROUP SPA -
BN161803:
POLARIS/BARON
ALI S.P.A.



1107229 MAGNETE

PER SENSORE IN
NEODIMIO /
MAGNET FOR
SENSOR
NEODYMIUM
3205:
ARISTARCO
KASTEL SPA



1107225 MAGNETE

CASADIO /
MAGNET CASADIO
998045000:
CASADIO HBS SRL
A SOCIO UNICO



1107182 MAGNETE
VAREC RLC9
BIANCO /
MAGNET RLC9
WHITE
CM19355005/0:
CASTEL MAC SPA



1107228 MAGNETE
MOD. RPV22 TR 3XG
VARMAG /
MAGNET MOD.
RPV22 TR 3XG
VARMAG
CM19354010/0:
CASTEL MAC SPA



1107089 MICROINT
ERRUTTORE
(NORMALMENTE
APERTO) /
MICRO-SWITCH
OPEN
23372:
BREMA ICE
MAKERS SPA
68023372:
RANCILIO SPA
9544800: MEIKO



1107088 MICROINT
ERRUTTORE
(NORMALMENTE
CHIUSO) /
MICRO-SWITCH
68023196:
RANCILIO SPA
085298:
ELECTROLUX
PROFESSIONAL
S.P.A.
23196:
BREMA ICE
MAKERS SPA



1107186 MICROGA
LLEGIANTE C/LEVA
74X7 VR-NA 15GR
2CONT. /
MICRO-SWITCH
FLOATER WITH
LEVER 74X7 VR-NA
15GR 2CONT.
926054:
BRICE ITALIA SRL



1107122 MICROS
WITCH X COD.2131 3/4 /
MICROSWITCH X
COD.2131 3/4
L2136: LUXIA SRL



1107058 MICRO
INVERSO 3 POLI /
MICRO-REVERSER 3
POLES



1107031 MICROINT
ERRUTTORE GH2 3
CONTATTI /
MICRO-SWITCH GH2
3CONCTATS
23055:
BREMA ICE
MAKERS SPA



1107203 Microinterr
uttore /
MICRO SWITCH
23930:
BREMA ICE
MAKERS SPA



1107133 MICRO A
LEVA LUNGA /
MICRO SWITCH
LONG LEVER
CM19410207/0:
CASTEL MAC SPA

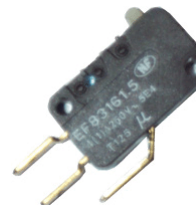

1107039 MICRO
FILO MOD.MP22-30-
40-50 /
MICRO-SWITCH
THREAD MOD.MP22-
30-40-50
3010320000:
STAFF ICE SYSTEM
SRL



1107137 LEVA
LUNGA CON
ROTELLA X(058) /
LEVER WITH ROLL
FOR MICROSWITCH
1107058



1107082 MICRO
DEVIATORE 16A
C/LEVA /
MICRO-SWITCH 16A
1037111300:
SILKO ALI SPA
25190007:
ELFRAMO SPA
30610:
SISTEMA PROJECT
MA1037111300:
SILKO ALI SPA
01035: FABAR SRL



1107180 SWITCH
LIMIT SPST 11AMP /
SWITCH LIMIT SPST
11 AMP

IOM910112402:
SCOTSMAN ICE
SRL



1107131 MICRO A
ROTELLA /
MICROSWITCH+WHE
EL

3010321000:
STAFF ICE SYSTEM
SRL



1107166 MICROINT
ERRUTTORE PORTA /
DOOR
MICROSWITCH

4095:
UNIVER-BAR SRL



1107243 MICROS
WITCH /
MICROSWITCH

62048600:
SCOTSMAN ICE
SRL



1107126 MICRO
16A NO STRUTTURA
METALLICA 23700 /
MICRO-SWITCH 16A
23700

23700:
BREMA ICE
MAKERS SPA

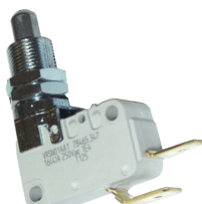

1107026 MICROINT
ERRUTTORE DI
SICUREZZA /
SAFETY MICRO-
SWITCH

PR70011: FABA SRL



1107128 MICROINT
ERRUTTORE DI
SICUREZZA 3
CONTATTI 16A /
SAFETY MICRO-
SWITCH 3
CONTACTS

4818135868: FAEMA
120313:

COMENDA ALI SPA
532020310: FAEMA
532020300: FAEMA
1519: FOINOX S.P.A.
539502: GICO SPA
LAR65260530:
LAINOX ALI SPA
50304530:



LAINOX ALI SPA

1107121 MICROINT
ERRUTTORE PER
TROPPO PIENO
GHIACCIO /
ICE OVER FLOW
MICROSWITCH

23373:

BREMA ICE
MAKERS SPA

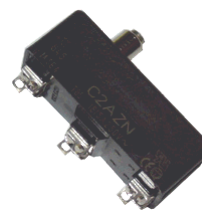

1107091 MICRODE
VIATORE 15A PRESS.
A LEVA /
MICRO-SWITCH 15A



1107056 MICRO
8319072 5A LEVA B A
VITE /
MICRO 8319072 5A
LEVER B WITH
SCREW

CM19410205/0:

CASTEL MAC SPA

CM19410205:

SCOTSMAN ICE
SRL

CM19410205/0:

CASTEL MAC SPA

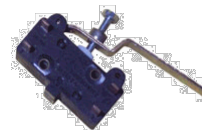

1107006 MICRO
Z15 HW 24B34049 /
MICRO-SWITCH Z15
HW 24B34049

CM19410200/0:

CASTEL MAC SPA



1107144 SWITCH
LIMIT (620395) /
SWITCH LIMIT
(620395)

1200205901:

SCOTSMAN ICE
SRL



1107092 MICRODE
VIATORE LEVA
PIANA CONT. /
MICRO-SWITCH

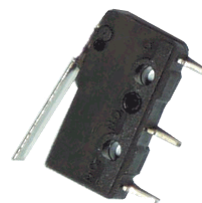

1107093 ATTUATO
RE LEVA
SAGOMATA /
MICRO-SWITCH

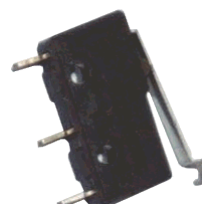

1107094 MICRODE
VIATORE A
PULSANTE
CONTINUO /
MICRO-SWITCH
WITH PUSH-BUTTON



1107095 ATTUATORE A LEVA CON ROTELLA CONT. / MICRO-SWITCH WITH SMALL WHEEL

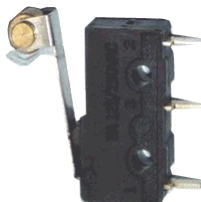

1107096 MICRODE
VIATORE LEVA
PIANA 3A 250V
TERM. CORSA /
MICRO-SWITCH 3A
250V



1107097 MICRODE
VIATORE LEVA
SAGOM. CTERM. PER
C.S3A UL /
MICRO-SWITCH 3A
UL

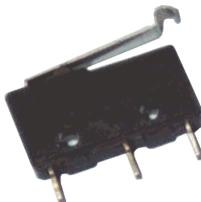

1107098 MICRODE
VIATORE A
PULSANTE TERM
PER C.S. 3 A UL /
MICRO-SWITCH 3A
UL

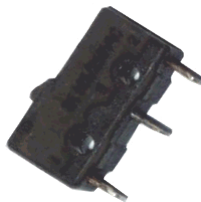

1107099 MICRODE
VIATORE
C/ROTELLA TERM 3A
/
MICRO-SWITCH
WITH SMALL WHEEL
3A



1107100 ATTUATORE A LEVA FASTON 4,8 LEVA 52MM / MICRO-SWITCH FASTON 4,8 52mm

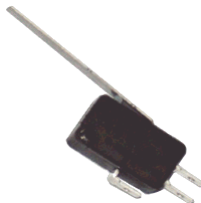

1107101 MICROINT
ERRUTTORE A LEVA
C.ROTELLA FASTON
4,8 /
MICRO-SWITCH
WITH SMALL WHEEL
FASTON 4,8



1107105 FINECORS
A PIST.C.ROTELLA
UNIDIREZ. /
MICRO-SWITCH
WITH SMALL WHEEL



1107120 MICROINT
ERRUTTORE /
MICROSWITCH

23746:

BREMA ICE
MAKERS SPA



1107109 FINECORS
A STELO A MOLLA /
LIMIT
MICROSWITCH
MICRO-SWITCH



1107111 FINECORS
A ASTA IN
POLIAMMIDE /
MICRO-SWITCH



1107159 MICROINT
ERRUTTORE PER
FRIGORIFERO /
MICRO SWITCH
REFRIGERATOR

084403:

ELECTROLUX
PROFESSIONAL
S.P.A.

1195009:

MONDIAL GROUP
S.R.L.



1107218 MICROINT
ERRUTT.
MECCANICO 2
TERMINALI NC /
MAGNET 8X16X40
Art M370 AP

164603:

POLARIS/BARON
BN164603:

OLIS DIVISIONE
DI ALI GROUP SPA -



1107160 MICROINT
ERRUTTORE PER
FRIGORIFERO /
MICRO SWITCH FOR
REFRIGERATOR

087485:

ELECTROLUX
PROFESSIONAL
S.P.A.



1107237 MICRO
PORTA FRIGO
FAGOR /
MICRO SWITCH FOR
REFRIGERATOR
FAGOR

6021130041:

FAGOR
INDUSTRIALE
S.R.L.



1107013 MICROINT
ERRUTTORE
MAGNETICO /
MAGNETIC MICRO-
SWITCH

13105: A.T.A. SRL



1107142 SENSORE
E510 ZC DA P076S /
DOOR TOUCH
SENSITIVE SWITCH
(REED CONTACT)

CM33210019/0:

CASTEL MAC SPA

CM33210019:

SCOTSMAN ICE
SRL

RECOC533:

EURFRIGOR SRL



=1107141

1107210 *MICRO
MAGNETICO
MODULARI /
MICRO MAGNETIC
MODULAR

CM33210013/0:

CASTEL MAC SPA



1107224 MAGNET
SWITCH /
MAGNET SWITCH

CM33210022:

SCOTSMAN ICE
SRL

CM33210022/0:

CASTEL MAC SPA



L=1500mm

1107068 SENSORE
MAGNETICO /
MAGNETIC MICRO-
SWITCH

120356: COMENDA
ALI

120366: HOONVED

33188: HOONVED



1107045 REED
SENZA TRIAC /
REED WITHOUT
TRIAC

120348:

COMENDA ALI SPA

120348:

HOONVED - ALI



SPA

1107048 REED
MICRO PORTA E530 /
REED MICRO DOOR
E530

DW3003112:

DIHR-ALI SPA



1107046 MICROCO
NTATTO
MAGNETICO REED /
MICROSWITCH
MAGNETIC REED

DW10778:

DIHR-ALI SPA

695001: GICO SPA



1107238 INTERRU
TORE MAGNETICO
CPL /
MAGNETIC SWITCH
Completo

088578:

ELECTROLUX

PROFESSIONAL

S.P.A.



1107223 MICROINT
ERRUTTORE +
ASTINA E CAVO /
MICRO SWITCH +
ROD AND CABLE

059565:

ELECTROLUX

PROFESSIONAL

S.P.A.



1107074 SENSORE
MAGNETICO /
TEMPERATURE
PROBE

9131616:

GRUPPO CIMBALI
SPA

984159000:

GRUPPO CIMBALI
SPA



1107240 REED
SWITCH /
REED SWITCH

00785470001:

HOBART GmbH



L=315mm

1107171 MICRO
PORTA COMPLETO /
DOOR MAGNETIC
SWITCH

R65265100:

LAINOX ALI SPA

LAR65265100:

LAINOX ALI SPA



1107020 MICROMA
GNETICO E510 1V
DA+M360 /
MAGNETIC MICRO-
SWITCH E510 1V
DA+M360

995405: LAINOX

ALI

MA5169100:

MARENO

25110113: ELFRAMO

211002ex:

ELETTROBAR

80871:

ELETTROBAR

FR995405: LAINOX

FR995405: SILKO

ALI



1105366 CURTAIN
SWITCH /
CURTAIN SWITCH

1100056306:

SCOTSMAN ICE

SRL

1100056301EX:

SCOTSMAN ICE

SRL



1107211 MICRO
MAGNETICO Ø 8 mm.

/
MICRO MAGNETIC
Ø 8 mm.



1105060 INTERRUT
TORE DI
PROSSIMITA' /
PROXIMITY SWITCH

23540:

BREMA ICE

MAKERS SPA



1107148 MAGNETO
ASSY /
MAGNET ASSY

*: CASTEL MAC SPA

78447600EX:

SCOTSMAN ICE

SRL

78447600R:

SCOTSMAN ICE

SRL



1107197 MAGNETO
ASSY /
MAGNET ASSY

78447601:

SCOTSMAN ICE

SRL

*: CASTEL MAC SPA

CMCF65051505EX:

CASTEL MAC SPA



1105387 SWITCH
FAN CYCLE /
SWITCH FAN CYCLE

IOM904109601:

SCOTSMAN ICE

SRL



1105372 POTENZIO

M.1 MOHM

LIN.S.I.0,25 /

POTENTIOMETER

HE09200:

OEM ALI SPA

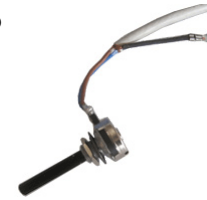

1107212 MICROINT

ERRUTTORI

CABLATI ARRESTO /

MICROSWITCHES

CABLED STOP

EB066AC: OBEL SRL



1105386 SWITCH /
SWITCH

1200240201:

SCOTSMAN ICE

SRL

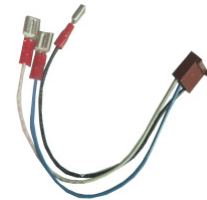

1107214 CURTAIN

SWITCH /





CURTAIN SWITCH



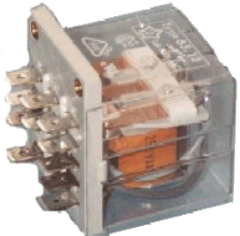
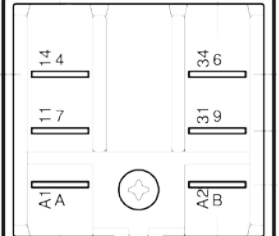
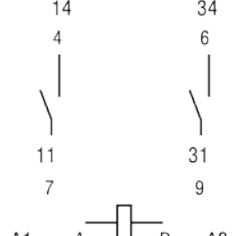
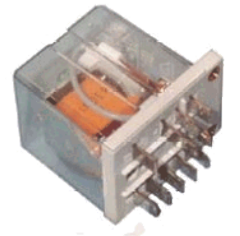
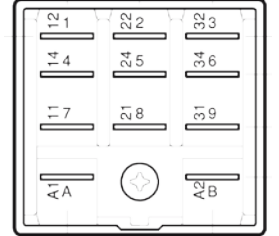
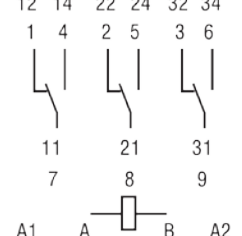
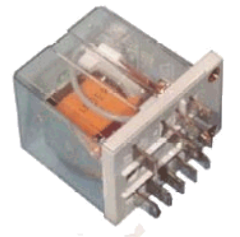
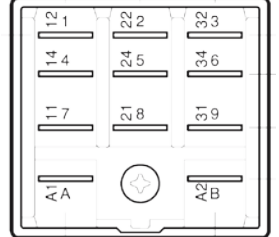
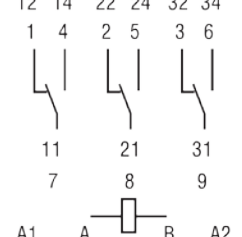
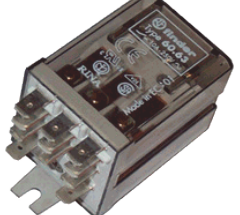
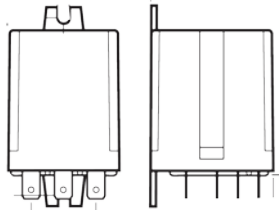
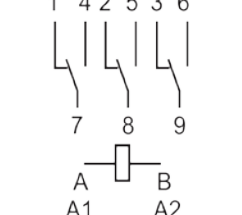

1100056304:

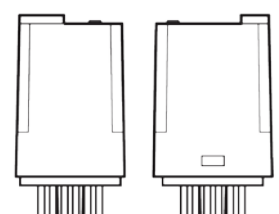
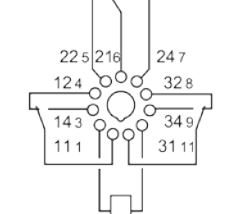
SCOTSMAN ICE

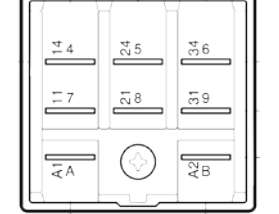
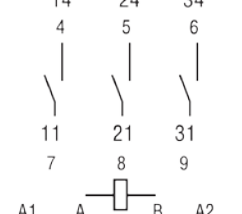
SRL

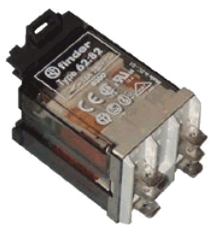
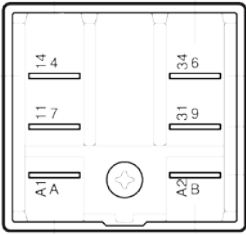
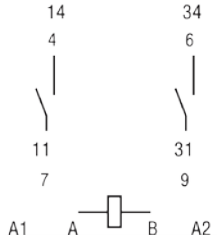

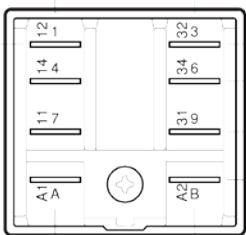
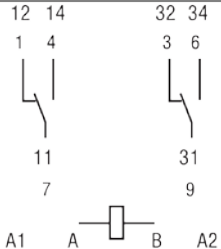
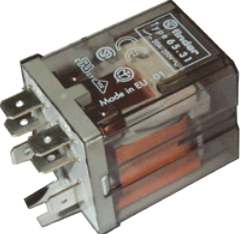
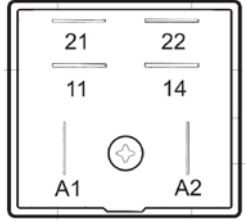
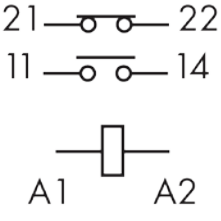
CODICE S&P S&P CODE		CONTATTI CONTACTS	SCHEMA ELETTRICO WIRING DIAGRAM	DESCRIZIONE DESCRIPTION
1109001				RELE' 230 V 16 AMPERE
1109005				RELE' 230 V 16 AMPERE
1109010				RELE' 24 V 16 AMPERE
1109015				RELE' 230V 10 AMPERE
1109021				RELE' 230V 10 AMPERE
1109024				RELE' 230V 16 AMPERE

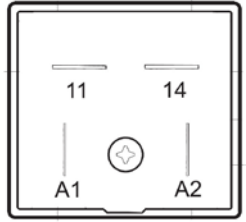
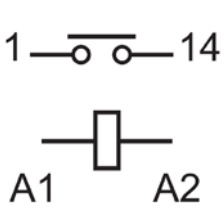
CODICE S&P S&P CODE		CONTATTI CONTACTS	SCHEMA ELETTRICO WIRING DIAGRAM	DESCRIZIONE DESCRIPTION
1109040				RELE' 230V 16 AMPERE
1109060				RELE' 230V 16 AMPERE
1109099				RELE' 230V 20 AMPERE
1109100				RELE' 230V 30 AMPERE

1109100 RELE' 30A

RELAY 30A
 1L T028: MIGEL
 S.R.L.
 229029:
 MBM- EUROTEC SRL
 - DIV. COOKING
 SERVICE
 229029:
 ELETTROBAR

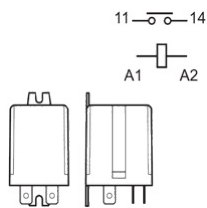

1109040 RELE
 FINDER 230V 50/60HZ
 GUIDA DIR /
 RELAY FINDER 230V
 50/60HZ
 DW560301:
 DIHR-ALI SPA

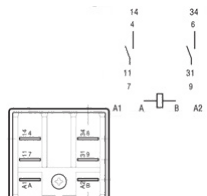

1109001 RELE' 230

16A /
 RELAY 230 SILANOS
 0301794:
 LAMBER DI AFFABA
 FRANCESCO & C.
 CR0687240:
 LAINOX ALI SPA
 E229039:
 HOBART GmbH
 4271: A.T.A. SRL
 905474*:
 SILANOS SRL
 DW16037:
 DIHR-ALI SPA
 229039:
 ELETTROBAR
 34200189:
 RANCILIO SPA
 CR0687240:
 SILKO ALI SPA
 4360:
 UNIVER-BAR SRL

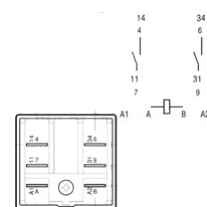

1109060 RELE' DI

POTENZA 16/250 /
RELAY 16/250

929115:

ELETTROBAR
DIVISIONE DELLA
EUROTEC SRL
34200037:
RANCILIO SPA

32Z2000:

ANGELO PO
GRANDI CUCINE
SPA

04200046:

NUOVA SIMONELLI
SPA

DW15620:

DIHR-ALI SPA
9531505700:
GRUPPO CIMBALI
SPA

33324:

HOONVED - ALI
SPA

EN125: OEM ALI
SPA

34312:

HOONVED - ALI
SPA

0301745:

LAMBER DI AFFABA
FRANCESCO & C.

25130100:

ELFRAMO SPA

LAR65170100:

LAINOX ALI SPA

LAR65170100:

OLIS DIVISIONE
DI ALI GROUP SPA -

DER1108:

ELETTROBAR
DIVISIONE DELLA
EUROTEC SRL

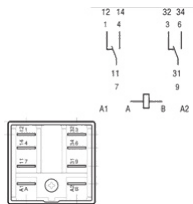

1109027 RELE'

220/50ATT/FAST.2SC
AMBI 10A /

RELAY 220/50

ATT/FAST.2

CHANGES 10A

229023:

ELETTROBAR
DIVISIONE DELLA
EUROTEC SRL

CM19620107:

SIMAG SPA

RI000761:

EURFRIGOR SRL

RI000761:

EURFRIGOR ICE

MAKERS SRL

CM19620107:

SCOTSMAN ICE

SRL

CM19620107/0:

CASTEL MAC SPA

926072:

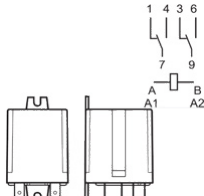

BRICE ITALIA SRL

CM19620101/0ex:

CASTEL MAC SPA

25130102:

ELFRAMO SPA

819620107:

GRUPPO CIMBALI

SPA

1109024 RELE'

TRIPOLARE 230V /
RELAY 230V MD80

229040:

ELETTROBAR
DIVISIONE DELLA
EUROTEC SRL

34200197*:

RANCILIO SPA

MD80: RANCILIO

SPA

0301795:

LAMBER DI AFFABA
FRANCESCO & C.

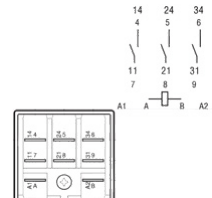

1109015 RELE' S20

220V /

RELAY S20 220V

RTFOC00144:

MBM- EUROTEC SRL
- DIV. COOKING

SERVICE

229024:

ELETTROBAR

23190:

BREMA ICE

MAKERS

056510:

ELECTROLUX

085296:

ELECTROLUX

086214:

ELECTROLUX

PROFESSIONAL

S.P.A.

056466:

ELECTROLUX

PROFESSIONAL

S.P.A.

62023702:

SCOTSMAN ICE

SRL

EU23190:

BRICE ITALIA SRL

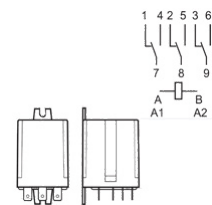

1109005 RELE'

FINDER TRIPOLARE

230V /

THREE POLAR

RELAY FINDER 230V

34200181:

RANCILIO SPA

34200192:

RANCILIO SPA

34200197:

RANCILIO SPA

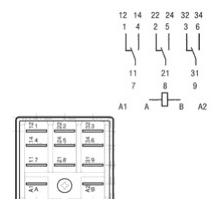
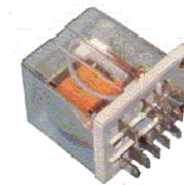

1109010 RELE' FINDER TRIP.
62838024 24VCA /
THREE-POLAR
RELAY FINDER
62838024 24VCA

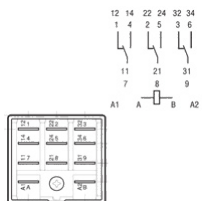
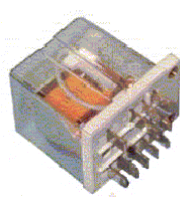

1109099 RELE 20A
230V /
RELAY 20A 230V
DER111:
COLGED

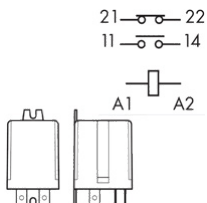
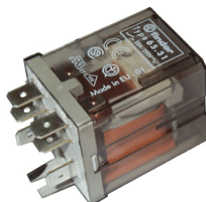

1109021 RELE' MD
50 FINDER /
RELAY MD 50
FINDER

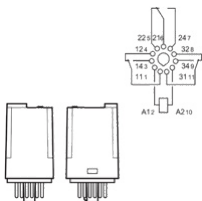

1109132 ADATTAT
ORE CON BOCCOLE
PER RELE' S.62 /
ADAPTER FOR
RELAY S.62



1109120 RELE'OMR
ON MK2P-S 230VAC /
RELAY OMRON
MK2P-S 230VAC
CM196201000:
CASTEL MAC SPA



1109150 RELAY /
RELAY
1800190350:
SCOTSMAN ICE
SRL



1109140 RELAY /
RELAY
IOM918101010:
SCOTSMAN ICE
SRL



1109149 RELAY /
RELAY
CM19621709:
SCOTSMAN ICE
SRL
CM196217090:
CASTEL MAC SPA



1109052 RELAY
SCOTSMAN /
RELAY SCOTSMAN
62016818:
SCOTSMAN ICE
SRL



1109156 RELAY /
RELAY
1800190329:
SCOTSMAN ICE
SRL



1109158 RELAY
9660.B451.131 /
RELAY 9660.B451.131
62005701:
SCOTSMAN ICE
SRL

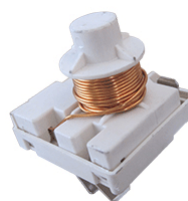

1109090 TELERUTT
ORE 230V 50-60HZ
20A AC1
MINICONTATTORE /
CONTACTOR 230V
50-60HZ 20A AC1
31873:
HOONVED - ALI
SPA
355:
ARISTARCO
KASTEL SPA



1109102 CONTATT
ORE 230V 50HZ
4.2KW AC3 POMPA
(11BF9) /
CONTACTOR 230V
50HZ 4.2KW AC3
PUMP (11BF9)
4375:
ARISTARCO
KASTEL SPA



1109098 TELERUTT
ORE 240V 50HZ NO /
RELAY 240V 50HZ NO
23594:
BREMA ICE MAKERS
SPA
DW15086/B:
DIHR-ALI SPA



1109112 TELERUTT
ORE /
RELAY
23147:
BREMA ICE MAKERS
SPA



1109141 TEL.11BG1
2.01A 220-230/5060/1 /
CONTACTOR
11BG12.01A 220-
230/5060/1

CM337307120:
CASTEL MAC SPA
CM33730712:
SCOTSMAN ICE
SRL



1109105 CONTACT
OR /
CONTACTOR
CMCF63012405:
CASTEL MAC SPA
63012405:
SCOTSMAN ICE
SRL

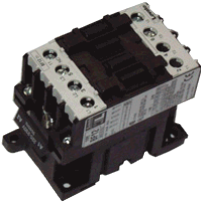

1109003 CONTATT
ORE 3TG USC.VITE
220V NC /
CONTACTOR 3TG
220V SCREW
CONNECTION
CECT:
OMNIWASH SRL -
SOCIETA' A SOCIO
UNICO



1109148 CONTACT
OR /
CONTACTOR
CM33730739:
SCOTSMAN ICE
SRL

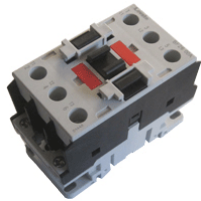

1109004 CONTATT
ORE 3TG USC.
FASTON 220V /
CONTACTOR 3TG
220V FASTON
CONNECTION
CECTF:
OMNIWASH SRL -
SOCIETA' A SOCIO
UNICO



1109152 RELE
CONTROLLO
TENSIONE 415/3/50-60
/
CONTROL VOLTAGE
RELAY 415/3 / 50-60
23903:
BREMA ICE MAKERS
SPA
N23903: N.T.F. SRL
23649:
BREMA ICE MAKERS
SPA



1109059 ZOCCOLO
MORSETTI /
CLAMPS CLOG

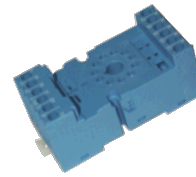

1109147 TRANSFO
RMER /
TRANSFORMER
CM33065119/0:
CASTEL MAC SPA
CM33065119:
SCOTSMAN ICE
SRL



1109087 TRANSFO
RMER /
TRANSFORMER
1200283601:
SCOTSMAN ICE
SRL



1109088 CONTACT
OR 24V. /
CONTACTOR 24V.
1200246901:
SCOTSMAN ICE
SRL



1109155 CONTATT
ORE 1200204802 /
CONTACTOR
1200204802
1200246902:
SCOTSMAN ICE
SRL

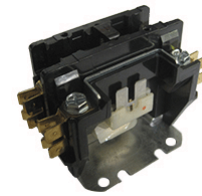

1112221 TIMER 10'
KASTEL /
TIMER 10' KASTEL
K00257:
ARISTARCO
KASTEL SPA



4 cammes, time 10'

1112185 TIMER ICE
MAKER KASTEL 12
MIN /
TIMER ICE MAKER
KASTEL 12 MIN
K00075:
ARISTARCO
KASTEL SPA



4 cammes, time 12'

1112304 TIMER

18min. 4 CAMME
V230M 50Hz /
TIMER 18min. CAMS 4
V230M 50Hz

KO1387:

ARISTARCO
KASTEL SPA



4 cammes 18'

1112099 TIMER 4

CAMME 8' 220/50 /
TIMER 4 CAMS 8'
220/50

23635:

BREMA ICE MAKERS
SPA

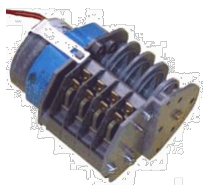

4 cammes, time 8'

1112010 TIMER

RITARDATORE
FB1140 /
DELAYER TIMER
FB1140

23099:

BREMA ICE MAKERS
SPA

12030883:

FAGOR
INDUSTRIALE
S.R.L.

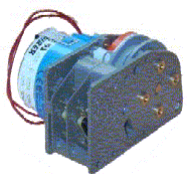

2 cammes, time 10'

1112124 TIMER 4

CAMME 8' 220/50 /
TIMER 4 CAMS 8'
220/50

23472:

BREMA ICE MAKERS
SPA



4 cammes, time 8'

1112013 TIMER 4

CAMME 10' BREMA /
TIMER CB184 BREMA

68023247:

RANCILIO SPA

CB184:

BREMA ICE MAKERS
SPA

6712019: N.T.F. SRL

926138:

BRICE ITALIA SRL



4 cammes, time 10'

1112003 TIMER 4

CAMME 12' BREMA /
TIMER 4 CAMS 12'
BREMA

6712020: N.T.F. SRL

N23222: N.T.F. SRL

68023222:

RANCILIO SPA

CB840;CB955;CB416,

CB249, CB246-CB316:

BREMA ICE MAKERS
SPA

085324:

ELECTROLUX
PROFESSIONAL

S.P.A.



4 cammes, =time 12'

1112118 TIMER 15'

BREMA CUB.MAGG. /
TIMER 15' BREMA

23248:

BREMA ICE MAKERS
SPA

085329:

ELECTROLUX

PROFESSIONAL

S.P.A.



4 cammes, time 15'

1112331 TIMER 4

CAMMES 15' 220V-
60HZ /
TIMER 4 CAMMES 15'
220V-60HZ

231078:

BREMA ICE MAKERS
SPA



4 cammes, time 15'

1112234 TIMER 15'

115V 60Hz /
TIMER 15' 115V 60Hz

23259:

BREMA ICE MAKERS
SPA



4 cammes, time 15'
115V

1112199 TIMER 18' /

TIMER 18'

N23870: N.T.F. SRL

23780:

BREMA ICE MAKERS
SPA



4 cammes, time 18'

1112197 PROGR.

CICLICO 220V/50Hz

12min ECP32..72 /

TIMER 220V/50HZ

12MIN ECP32..72

ECP18-ECP22-ECP32-

ECP42-ECP62-

ECP72-ECP110:

EURFRIGOR ICE

MAKERS SRL

RF50B869:

BRICE ITALIA SRL

926070:

BRICE ITALIA SRL



4 cammes, time 12'

1112272 PROGR.

CICLICO 220V/50HZ

18MIN ECP 40GR /

TIMER 18' ECP 40GR

220V 50HZ

RF50C566:

EURFRIGOR SRL

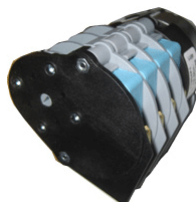

4 cammes, time 18'

1112322 4864

TIMER 15' 220/50-

60HZ /

TIMER 15' 220V

50/60HZ

304864: I.T.V. S.A.



2 cammes, time 15'

1112318 380
PROGRAMMATORE 20'
ITV /
380 TIMER 20 TTV
100380: I.T.V. S.A.



2 cammes, time 20'

1112079 TIMER 12
MINUTI /
TIMER 12 MINUTS
62024413:
SCOTSMAN ICE
SRL

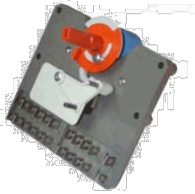

1 cammes, time 12'

1112032 TIMER
MOD. P23 15' MOD.
AC 225 /
TIMER MOD. P23
MOD. AC 225 SCOT
62024404:
SCOTSMAN ICE
SRL

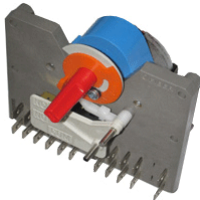

1 camma, time 15'

1112114 TIMER
P36/36 230V 50HZ /
TIMER P36/36 230V
50HZ
SD22, SDN80:
SIMAG SPA
CM19800001/0ex:
CASTEL MAC SPA
889125071: FAEMA
CM81414562/0:
CASTEL MAC SPA

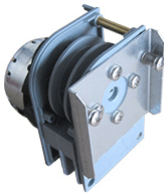

2 cammes, time 12'

1112288 TIMER
P195 /
TIMER P195



2 cammes

1112262 TIMER
FIBER P365JR3J736
TEMPO 15' /
TIMER FIBER
P365JR3J736 15'

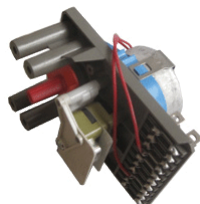

2 cammes, time 15'

1112243 TEMPORIZ
ZATORE
SBRINAMENTO D94 -
442 /
DEFROST TIMER
D94-442



2 cammes, time 8H

1112218 TEMPORIZ
ZATORE CICLICO
SBRINATORE
13102/24H CODICE
555218 /
DEFROST TIMER
13102/24H CODE
555218



2 cammes, time 24H

1112291 TIMER
ASSY 220/60 /
TIMER ASSY 220/60
1200231722:
SCOTSMAN ICE
SRL



1112098 MOTORE
M37R SINCRONO
375RPM 50HZ 230VAC
/
TIMER MOTOR M37R
375RPM 50HZ 230VAC



1112275 MOTORIN
O TIMER CDC M37R
24VAC /
TIMER MOTOR CDC
M37R 24VAC



1112094 MOTORE
M37L SINCRONO
375RPM 50HZ 230VAC
/
TIMER MOTOR M37L
375RPM 50HZ 230V
AC

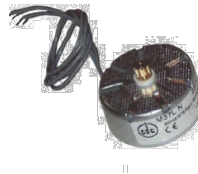

1112284 MOTORE
M42 /
MOTOR M42



1112223 MOTORIN
O TIMER CDC M48R
240V AC 50Hz /
TIMER MOTOR CDC
M48R 240V AC 50Hz
36570:
HOONVED - ALI
SPA



1112247 MOTORIN
O TIMER M48L 230V /
TIMER MOTOR M48L
230V



1112071 MOTORIN
O TIMER FIBER M61R
230V /
TIMER MOTOR FIBER
M61R 230V



1112267 MOTORIN
O FIBER M61L 230V /
MOTOR FIBER M61L
230V

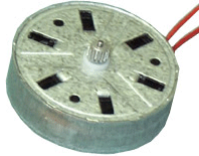

1112067 TIMER
ELETTRONICO TARI

/
ELECTRONIC TIMER
TARI

23560:

BREMA ICE MAKERS
SPA



1112287 TEMPORIZ

.BARFY03V220/50 /

TIMER

BARFY03V220/50

62038703ex:

SCOTSMAN ICE
SRL

06052600:

SCOTSMAN ICE
SRL

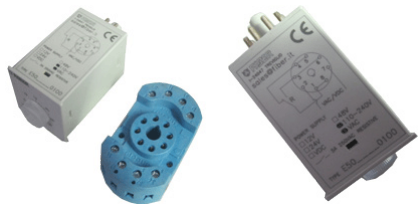

1112265 TIMER /
TIMER

IOM910114801:

SCOTSMAN ICE
SRL



1112294 CONTAIM

PULSI

MULTITENSIONE A 4

CIFRE /

MULTIVOLTAGE

COUNTER 4 DIGIT



1113139 PRESSOST

ATO TIPO KP7B

(PED) /

PRESSOSTAT KP7B

(PED)

23729:

BREMA ICE
MAKERS SPA



1113084 PRESS.8//1

0 BAR 1/4 SAE KP5 /

PRESSURE SWITCH

8//10 BAR 1/4 SAE

KP5

819550372:

GRUPPO CIMBALI
SPA

CM19550372:

SIMAG SPA

N21S:

CASTEL MAC SPA

CM19550372:

SCOTSMAN ICE

SRL



1113080 PRESSUR

E CONTROL /

PRESSURE

CONTROL

62024100:

SCOTSMAN ICE

SRL



1113021 PRESSOST

ATO RANCO 016-703

/

PRESSURE SWITCH

RANCO 016-703



1113038 PRESSOST

ATO SCOTSMAN /

PRESSURE SWITCH

SCOTSMAN

62023101:

SCOTSMAN ICE

SRL

62023100EX:

SCOTSMAN ICE

SRL

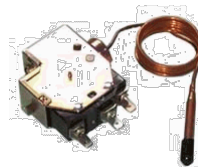

1113058 PRESSOST

ATO P20EA-9950KAM

/

PRESSURE SWITCH

P20EA-9950KAM

62050800:

SCOTSMAN ICE

SRL

62007502EX:

SCOTSMAN ICE

SRL



1113116 Pressostato

condensatorQ15-E3e /

pressure condenser e3e-

Q15

23906:

BREMA ICE

MAKERS SPA

926115:

BRICE ITALIA SRL



1113140 PRESSOST
ATO DI SICUREZZA
H.P. OUT 31 IN 22,5 /
SAFETY PRESSURE
SWITCH H.P. OUT 31
IN 22.5
23976:
BREMA ICE
MAKERS SPA



1113145 PRESSOST
ATO DI SICUREZZA
L.P. NSDLA10A12101
/
SAFETY PRESSURE
SWITCH L.P.
NSDLA10A12101
23909:
BREMA ICE
MAKERS SPA



1113137 PRESSOST
ATO 8.0//11.0 250V 6A
DANFOSS ACB- /
PRESSURE 8.0 // 11.0
250V 6A DANFOSS
ACB
CM19550632/0:
CASTEL MAC SPA



1113079 PRESSOST
ATO HTBX115 /
PRESSURE SWITCH
HTBX115
1L T042: MIGEL
S.R.L.
1L T093EX:
MIGEL S.R.L.



1113097 PRESSOST
ATO HTBX112 /
PRESSURE SWITCH
HTBX112
1L T075: MIGEL
S.R.L.



1113061 PRESSOST
ATO SCOTSMAN /
PRESSURE SWITCH
SCOTSMAN
62007505ex:
SCOTSMAN ICE
SRL
62049901:
SCOTSMAN ICE
SRL
*: CASTEL MAC SPA
889125058:
GRUPPO CIMBALI
SPA



1113096 PRESSOST
AT /
PRESSURE SWITCH
62045100:
SCOTSMAN ICE
SRL



1113117 FANCONT
ROL /
FANCONTROL
1100047921:
SCOTSMAN ICE
SRL



1113150 PRESSOST
AT /
PRESSURE SWITCH
62049900:
SCOTSMAN ICE
SRL



1113148 HI.
PRESS.CTL. /
HI. PRESS.CTL.
1100050121:
SCOTSMAN ICE
SRL



1113133 HI
PRESSURE CTRL /
HI PRESSURE CTRL
IOM904109101:
SCOTSMAN ICE
SRL



1113098 PRESSUR
E SWITCH /
PRESSURE SWITCH
CM25474401/0:
CASTEL MAC SPA
CM25474401:
SCOTSMAN ICE
SRL

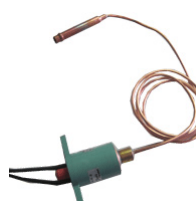

1113127 PRESSOST
ATO /
PRESSURE SWITCH
CM81453749/0:
CASTEL MAC SPA
CM81453749:
SCOTSMAN ICE
SRL



1113081 ASS.MINI
PRESS.MAX 22<33
MOD.450...1000 /
PRESSURE SWITCH
MAX 22<33
MOD.450...1000

CM25474402:

SCOTSMAN ICE
SRL

CM25474402/0:

CASTEL MAC SPA



1113005 PRESSOST
ATO
CONDENSATORE /
CONDENSER
PRESSURE SWITCH
*****:

RANCILIO SPA

23175:

BREMA ICE

MAKERS SPA

085297:

ELECTROLUX

PROFESSIONAL

S.P.A.



1113071 PRESSOST
ATO HTB-X3028 /
PRESSURE SWITCH
HTB-X3028

926069:

BRICE ITALIA SRL

RF000621:

EURFRIGOR ICE

MAKERS SRL

RF000621:

EURFRIGOR SRL



1113074 PRESSOST
ATO DI SICUREZZA
(MASSIMA
PRESSIONE) /
SAFETY PRESSURE
SWITCH

23342:

BREMA ICE

MAKERS SPA



1113111 PRESSOST
AT /
PRESSOSTAT

CMNX62007500:

CASTEL MAC SPA

62007500:

SCOTSMAN ICE

SRL



1114172 SCHELET
TR.ABB.ORIZZ. /
P.C. BOARD A.PO

32V0421:

ANGELO PO

GRANDI CUCINE

SPA



1114367 SCHEDA
ELETTRONICA KP
REV.02 /
PC BOARD KP REV.02

K04720:

ARISTARCO

KASTEL SPA

K04601EX:

ARISTARCO

KASTEL



1114193 SCHEDA
ELETTRONICA E2
GRANULARI 230 VAC
/
MAIN PCB 230 VAC

RI003551:

BRICE ITALIA SRL

RI003551:

EURFRIGOR ICE

MAKERS SRL



1114068 SCHEDA
GRANULARE
ELETTRONICA
SCOTSMAN /
P.C.BOARD
SCOTSMAN

CM81449089/0:

CASTEL MAC SPA

F200:

CASTEL MAC SPA

62046202:

SCOTSMAN ICE

SRL

CM81469134/0ex:

CASTEL MAC SPA

62045602EX:

SCOTSMAN ICE

SRL

CM29070012/0EX:

CASTEL MAC SPA

EX62040303:

SCOTSMAN ICE

SRL



1114176 SCHEDA
ESPANSIONE C-
2003RTC + 2 RELÔ /
P.C. BOARD C-
2003RTC + 2 REL?

CM33580166/0:

CASTEL MAC SPA



1114175 SCHEDA
MICRO-RELÔ C-2003 /
MICRO-REL? P.C.
BOARD C-2003

CM33580167/0:

CASTEL MAC SPA



1114447 ASS.SCHE
DA EL.+SCATOLA
E21...140 /
CIRCUIT BOARD
ASSEMBLY E21 140 ...
CM814001240:
CASTEL MAC SPA



bin probe=1129230,
temperature
probe=1129229

1114572 SCHEDA
LEDS MODULARI
ICEMOD4 HW
SCM039-R0 /
MODULAR DATA
LEDS ICEMOD4 HW
SCM039-R0
CM335801510:
CASTEL MAC SPA



1114586 MEMBRA
NA PGD1 X PLUS+ /
MEMBRANA PGD1 X
PLUS +
CM334895680:
CASTEL MAC SPA

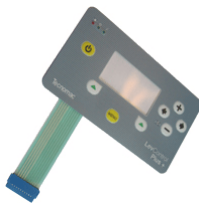

1114053 SCHEDA
BASE F90-160 /
BASIS P.C. BOARD
F90-160
I33580100:GIGA
CM33580100/0:
CASTEL MAC SPA
RECO535:
EURFRIGOR ICE
CM33580100:
SCOTSMAN ICE
SRL



1114010 P.C.
BOARD SCOTSMAN /
P.C. BOARD
I62040316:
GIGA GRANDI
CUCINE
BARLINE20:
SCOTSMAN ICE
SRL
CMXP62040316:
CASTEL MAC SPA
086368:
ELECTROLUX.



1114282 SCHEDA
MADRE /
P.C. BOARD
088344:
ELECTROLUX
PROFESSIONAL
S.P.A.



4122163 "MASCHE
RINA; WITH
BUTTON" /
"MASK, WITH
BUTTON"
092398:
ELECTROLUX
PROFESSIONAL
S.P.A.



1114639 SCHEDA
DI POTENZA PER
ABBATTITORE DI
TEMPERATURA /
POWER CIRCUIT
BOARD FOR BLAST
CHILLER
70520: FOINOX
S.P.A.



1114525 ASSIEME
SCHEDA
ELETTRONICA EVCO
STD HBR /
CIRCUIT BOARD
ASSEMBLY EVCO
STD HBR
FR996442:
HIBER - ALI S.p.A.
FR996442:
LAINOX ALI SPA
FR996442: SILKO
ALI

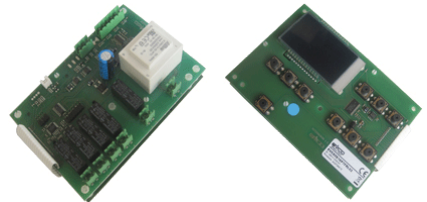

1106717 TERMOST
ATO
EVC20S35N7ALX30 3
RELE /
THERMOSTAT
EVC20S35N7ALX30 3
RELAY
BN1681114:
LAINOX ALI SPA

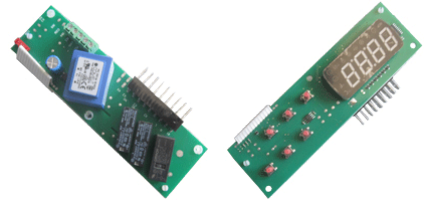

1114695 SCHEDA
DISPLAY
INTERFACCIA
ABBATTITORE /
BLAST CHILLER
DISPLAY P.C. BOARD

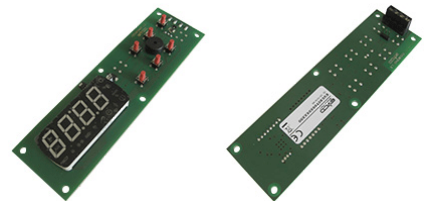

1114646 KIT
PANNELLO
COMANDI PER
ABBATTITORE
LAINOX NEW S/T /
KIT CONTROL
PANEL FOR BLAST
CHILLER LAINOX
NEW S / T
FR966061:
FRIULINOX S.R.L.
FR966061:
LAINOX ALI SPA
FR966061: SILKO
ALI



1114620 SCHEDA
DI CONTROLLO
CUBETTI SPIKA
220V/50-60Hz ITV /
CONTROL BOARD
CUBES SPIKA 220V /
50-60Hz ITV
8143: I.T.V. S.A.



1114197 SCHEDA
TASTIERA /
P.C. BOARD
RA910070:
MARENO
INDUSTRIE
RA910070:
LAINOX ALI SPA

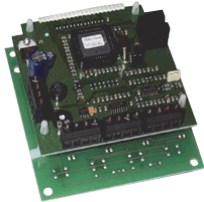

1114198 SCHEDA
BASE 7 RELE' /
P.C. BOARD 7
RELAYS
R65300520:
LAINOX ALI SPA
LAR65300520:
MARENO
INDUSTRIE
RA910060:
MARENO
INDUSTRIE
RA910060: LAINOX
LAR65300520:
LAINOX ALI SPA



1114252 SCHEDA
ELETTRONICA KF
230V/50HZ /
P.C.BOARD KF
230V/50HZ
1L T014: MIGEL
S.R.L.



1114680 SCHEDA
TIMER P36/37 EX
1LT017 (TMEC1) /
TIMER BOARD P36/37
EX 1LT017 (TMEC1)
1L T199: MIGEL
S.R.L.



1112279 TIMER /
TIMER
SDN 85:
SCOTSMAN ICE
SRL



1114131 SCHEDA
SCA230+INV+COP.AS
S GRANULARE /
PC BOARD ASSY
***: SCOTSMAN ICE**
SRL



1114285 P.C.
BOARD /
P.C. BOARD
CM33580064:
SCOTSMAN ICE
SRL



1114556 PC BOARD
/
PC BOARD
62048903:
SCOTSMAN ICE
SRL



1114397 PC BOARD
/
PC BOARD
CM33580250:
SCOTSMAN ICE
SRL
CM33580250/0:
CASTEL MAC SPA
CM33580150/0:
CASTEL MAC SPA
CM33580150ex:
SCOTSMAN ICE
SRL



1114443 SERVICE
CIRCUIT BOARD /
SERVICE CIRCUIT
BOARD
1200283521:
SCOTSMAN ICE
SRL
1200283522:
SCOTSMAN ICE
SRL



1114401 KIT
SCHEDA AC-MC
CUBETTI /
PC BOARD KIT AC-
MC
AC/EC106,126,176,2
06,226
MC16,46,1210:
SCOTSMAN ICE
SRL



1114402 KIT
SCHEDA AF/MF /
PC BOARD KIT
AF/MF
AF20,30,80,100,200,
MF26,36,46,56,58,M
FN46,56:
SCOTSMAN ICE
SRL



1114466 PCBOARD
KIT- AF10 /
PCBOARD KIT-AF10
AF10:
SCOTSMAN ICE
SRL

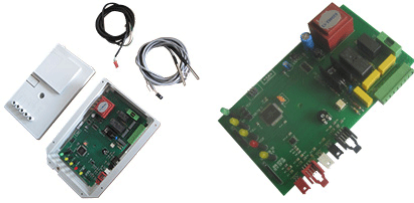

1114478 PCB ASSY
/
PCB ASSY
62046203:
SCOTSMAN ICE
SRL



1114468 PCBOARD
NTC /
PCBOARDNTC
62046213:
SCOTSMAN ICE
SRL



1114403 KIT
SCHEMA TC /
PC BOARD KIT
TC180:
SCOTSMAN ICE
SRL



1114404 KIT
SCHEMA
AC/EC46/56/86 /
PC BOARD KIT
AC/EC46/56/86
AC/EC46, AC/EC56,
AC/EC86:
SCOTSMAN ICE
SRL



1114607 KIT PC
BOARD NTC - MF 66-
61 /
KIT PC BOARD NTC -
MF 66
06071116:
SCOTSMAN ICE
SRL



1114456 PCBOARD-
BOXASSY /
PCBOARD-BOXASSY
62044805:
SCOTSMAN ICE
SRL



1114613 PC BOARD
/
PC BOARD
1200284321:
SCOTSMAN ICE
SRL

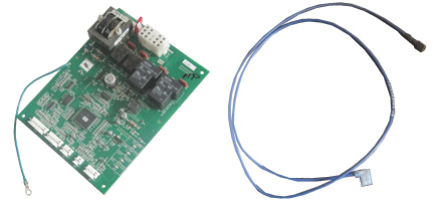

1114407 TIMER /
PC BOARD
62050700: SIMAG
SPA
62050700:
SCOTSMAN ICE
SRL
889620507:
GRUPPO CIMBALI
SPA



1114533 SCHEMA
ELETTRONICA
RITARDO
AVVIAMENTO /
START DELAYED
ELECTRONIC CARD
CM33580173:
SCOTSMAN ICE
SRL
CM335801730:
CASTEL MAC SPA



1114592 PC BOARD
/
PC BOARD
CM81455138:
SCOTSMAN ICE
SRL
CM81455138/0:
CASTEL MAC SPA



1114638 PC BOARD
TCL180-TCS180 /
PC BOARD
TCL18-TCS180:
SCOTSMAN ICE
SRL



1114506 SCHEMA
ELETTR. LIV.H20 X
POMPA SCARICO
PWD /
PCB H20 FOR DRAIN
PUMP PWD
62047000:
SCOTSMAN ICE
SRL
CMCF62047000:
CASTEL MAC SPA



1114643 KIT
SCHEDE TIMER-
RETROFIT /
RETROFIT KIT
TIMER-CARD

06076900:

SCOTSMAN ICE
SRL

*: CASTEL MAC SPA



1114507 CONTROL
BOX /
CONTROLBOX

66071200:

SCOTSMAN ICE
SRL



4122064 PANNELLO
COMANDI /
MEMBRANESWITCH
KIT

06061300:

SCOTSMAN DIV.
FRIMONT SPA



1114173 SCHEDE
ELETTRONICA
CME506 SCTSM /
P.C. BOARD CME506
SCTSM

0A03770321:

SCOTSMAN ICE
SRL

1200283824:

SCOTSMAN ICE
SRL

1200283823:

SCOTSMAN ICE
SRL



1114412 LED
BOARD /
LED BOARD

CM33580084:

SCOTSMAN ICE
SRL

CM33580084/0:

CASTEL MAC SPA



1114683 DISPLAY
BOARD /
DISPLAY BOARD

62048303:

SCOTSMAN ICE
SRL



1114108 SCHEDE
LED 4LED+RES ICE /
DISPLAY P.C.B. 4 LED
+RES ICE

CM33580024:

SCOTSMAN ICE
SRL

CM33580024/0:

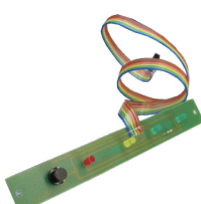

CASTEL MAC SPA

1114340 SCHEDE
LEDS MODULARI
ICEMOD4 HW
SCM039-R0 /
DISPLAY PCB
SCM039-R0

RECOC536:

EURFRIGOR SRL

CM33580151:

SCOTSMAN ICE
SRL

CM33580151/0:

CASTEL MAC SPA



1114666 SCHEDE
PULSANTI V. C-2003
ART.CT1MA08100 /
KEYPAD BOARD V.
C-2003
ART.CT1MA08100

CM33580168:

SCOTSMAN ICE
SRL

CM33580168/0:

CASTEL MAC SPA



1114334 RITARDAT
ORE ELETTRONICO
MINI/QUARK
BUDGET/TARGET /
PC BOARD
MINI/QUARK
BUDGET/TARGET

2270000600:

UGOLINI SPA



1114485

RITARDATORE
ELETTRONICO 1
VASCA CON SICURA
/

RETARDER 1 TANK
WITH ELECTRONIC
SAFETY

2280005251:

UGOLINI SPA



1114482 RITARDAT
ORE ELETTRONICO
123 VASCHE L/UL /
RETARDER
ELECTRONIC TANKS
123 L / UL

2280005240:

UGOLINI SPA

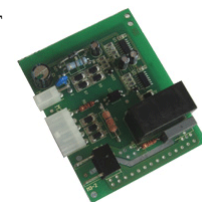

1114475 RITARDAT
ORE ELETTRONICO 3
VASCHE CON
SICURA /
PCB

2280005253:

UGOLINI SPA

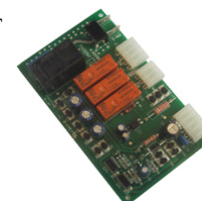

1114531 SCHEDA
DI POTENZA
GRANIT.1V 230V CON
TERMOSTATO /
POWER BOARD
GRANIT.1V 230V
WITH THERMOSTAT

2270000610:
UGOLINI SPA



1114532 SCHEDA
DISPLAY PER
GRANITORE CON
TERMOSTATO /
THERMOSTAT WITH
DISPLAY BOARD
FOR SLUSH
MACHINE

2270000640:
UGOLINI SPA

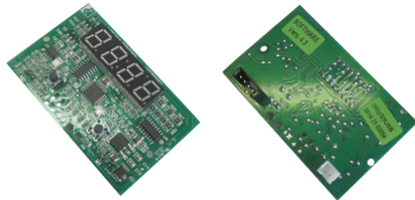

4119035 RITARDAT
ORE MT2GLS
FASTON /
P.C. BOARD MT2GLS
FASTON

2280005201:
UGOLINI SPA

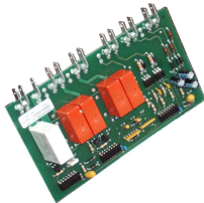

4119036 RITARDAT
ORE MT3GLS
FASTON /
P.C. BOARD MT3GLS
FASTON

2280005202:
UGOLINI SPA

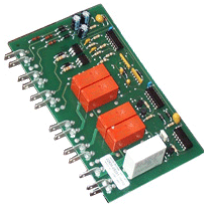

1114679 RITARDAT
ORE E. 1 VASCA
PLUS 230/240V 50HZ /
P.C. BOARD
RETARDER E. 1
BATH PLUS 230 /
240V 50HZ

2280005203:
UGOLINI SPA

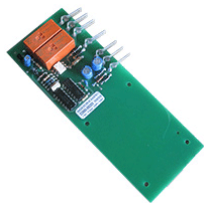

1114543 SCHEDA
CONTROLORE
ABBATTITORE V1.2 /
CONTROLLER
BOARD BLAST
CHILLER V1.2

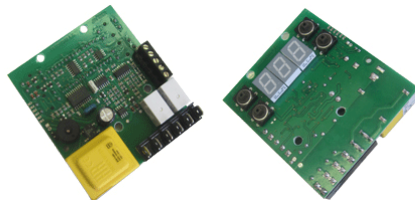

1114553 TASTIERA
T670 /
KEYBOARD T670

T670:
DSL - DIVISIONE
DI IFI S.P.A.



1114555 CENTRALI
NA TERMOSTATO
ITV SERIE GALA DP /
ITV SERIES
THERMOSTAT UNIT
DP-GALA

5281: I.T.V. S.A.



1114545 ASSIEME
TIMER*
TERMOSTATO ITV /
ITV SERIES
THERMOSTAT UNIT
DP-GALA

5381: I.T.V. S.A.



1114547 TIMER
ELETTRICALVOLA
SORBY 1 TSD /
TIMER SOLENOID
VALVE Sorby 1 TSD



1114634 TIMER
ECONOMICO 1
GRUPPO /
TIMER

04BA0133001:
KSERVICE



1114333 REGOLAT
ORE DI LIVELLO;
RL30/3ES/F/G /
LEVEL RELAY
RL30/3ES/F/G

055458:

ELECTROLUX
PROFESSIONAL
S.P.A.

0102477:

SILKO ALI SPA
639624051: GICO
SPA

SIR0102477:

SILKO ALI SPA
RTFOC00146:

MBM- EUROTEC SRL
- DIV. COOKING
SERVICE



4114687 DRUM
ROTATION CONTROL
PCB /
DRUM ROTATION
CONTROL PCB

62048800:
SCOTSMAN DIV.
FRIMONT SPA



1117030 MOLLA
SOSTEGNO
MOTORIDUTTORE /
MOTO REDUCER
SPRING
20228:
**BREMA ICE MAKERS
SPA**



1117315 MOLLA DI
ALLEGGERIMENTO /
SPRING
201067:
**BREMA ICE MAKERS
SPA**



1117190 MOLLA DI
ALLEGGERIMENTO /
SPRING RELIEF
20810:
**BREMA ICE MAKERS
SPA**



1117011 MOLLA
RIBALT.BACINELLA
N4-6 /
BASIN OVERTURN
SPRING N4-6
CM25474602/0:
**CASTEL MAC SPA
SCOTSMAN ICE
SRL**



1117013 MOLLA
RIBALT.BACINELLA
N 1-2 /
BASIN OVERTURN
SPRING N1-2
CM25474600/0:
**CASTEL MAC SPA
SCOTSMAN ICE
SRL
825474600:
GRUPPO CIMBALI
SPA
CM25474600:
SIMAG SPA**



1117151 MOLLA X
RIB.BACINELLA N
12-22 /
SPRING FOR BASIN
SET
CM25474601/0:
CASTEL MAC SPA



1117194 SPRING /
SPRING
65041401:
**SCOTSMAN ICE
SRL**



1117244 MOLLA
PER RUBINETTO
GRANITORE /
GRAINER COCK
SPRING
2280015000:
UGOLINI SPA



1117200 MOLLA
RUBINETTO /
TAP SPRING
2280026424:
UGOLINI SPA



1117275 MOLLA
NEW RUBINETTO
GRANITORI 6-10-
15LT /
NEW TAP SPRING
GRANITA MACHINES
6-10-15LT
2280015002:
UGOLINI SPA



1117109 MOLLA DI
ALLEGGERIMENTO
BACINELLA /
BASIN SPRING
20282:
**BREMA ICE MAKERS
SPA**



1117058 MOLLA DI
ALLEGGERIMENTO
BASCULANTE /
SPRING FOR DOOR
20464:
**BREMA ICE MAKERS
SPA**



1117254 MOLLA X
ALBERO PALETTE N
CUBETTO /
SPRING FOR PADDLE
SHAFT - N CUBE
923030:
**BRICE ITALIA SRL
RR003629:
EURFRIGOR ICE
MAKERS SRL
RR003629:
EURFRIGOR SRL**



1117012 MOLLA
TRAZIONE 36042 /
TRACTION SPRING
36042

CM25475400/O:
CASTEL MAC SPA
CM25475400:
SCOTSMAN ICE
SRL
CM25475400/O:
CASTEL MAC SPA

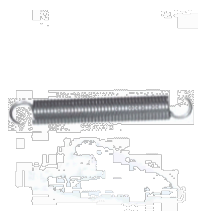

1117763 MOLLA
PER REGOLAZIONE
DENSITA' /
SPRING ADJUSTING
DENSITY

2280016800:
UGOLINI SPA



1117783 PISTONCI
NO A GAS 200 newton
/

PISTON GAS 200
newton
36H1140:
ANGELO PO
GRANDI CUCINE
SPA



1117129 MOLLA A
GAS CB /
GAS SPRING CB
ECV1050- ECV/SELF
2076: CB SRL



1117800 MOLLA A
GAS 156.262.18 /
GAS SPRING
156.262.18
5400108:

OEM ALI SPA
5400091:
OEM ALI SPA



1117290 PISTONE
VALKO 250N /
LID FOR SHOCK
ABSORBER 0250N

10080053: VALKO
SRL



1117060 MOLLE A
GAS LIFT O MAT 230 /
GAS SPRING LIFT O
MAT 230



1117068 MOLLE A
GAS LIFT O MAT SA
226,5 /
GAS SPRING LIFT O
MAT SA 226,5



1117089 MOLLE A
GAS FS
03010816100850500 /
GAS SPRING FS
03010816100850500



1117092 MOLLE A
GAS LIFT O MAT
600N 690430 /
GAS SPRING LIFT O
MAT 600N 690430



1117107 PISTONE
LIFT O MAT 690422 0
500N /
SPRING LIFT O MAT
690422 0 500N



1117149 MOLLA
GAS LIFT-O-MAT
400N 690384 /
GAS SPRING LIFT-O-
MAT 400N 690384



1117195 MOLLA
HYDROLIFT 0300N /
SPRING HYDROLIFT
0300N



1117223 PISTONE
LIFT-O-MAT 278076 /
SPRING LIFT O MAT
278076



1117233 MOLLA A
GAS 082430 /
GAS SPRING 082430



1117234 PISTONE
HIDRO-LIFT 2607GS
0200N /
SPRING HIDRO-LIFT
2607GS 0200N



1117294 MOLLA
LIFT-O-MAT 690N
690449 /
GAS SPRING LIFT O
MAT 690N 690449



1117298 MOLLA
GAS LIFT O MAT
0100N 082570 /
SPRING LIFT GAS OR
MAT 0100N 082 570



1117302 MOLLA A
PISTONE LIFT O MAT
291250 /
GAS SPRING PISTON
LIFT O MAT 291250



1117306 MOLLA A
GAS 0308060000-0200
HYDRO LIFT 210N /
GAS SPRING
0308060000-0200
HYDRO LIFT 210N



1117307 MOLLA A
GAS 0306120000-0300
LIFT O MAT SA 305,5
/
GAS SPRING
0306120000-0300 LIFT
O MAT SA 305,5



1117766 MOLLA A
GAS 0400N FORO 8,2 -
6 + GRANO 90° /
GAS SPRING 0400N
HOLE 8.2 to 6 + 90 °
WHEAT



1117764 ASSIEME
MOLLA DX ARMADI
REFRIGERATI /
TOGETHER SPRING
DX CABINETS
R30875: ILSA SPA



1117765 ASSIEME
MOLLA SX ARMADI
REFRIGERATI /
TOGETHER SPRING
SX CABINETS
R30876: ILSA SPA



1117749 MOLLA A
LAMINA DOSATORE
/
SPRING SHEET
DISPENSER
EB070: OBEL SRL



1117753 MOLLA A
LAMINA /
LAMINATE SPRING
DF70: OBEL SRL



1117754 MOLLA
CONTATTO
ELETTRICO
COMPLETO DI
PIASTRINA /
ELECTRICAL
CONTACT WITH
SPRING PLATE
2280015202:
UGOLINI SPA



1124007 ELETTRO
VALVOLA 1 VIA 90°
D.10,5 /
SOLENOID VALVE 1
WAY 90° D. 10,5
120145: COMENDA
ALI

394: ARISTARCO
AL10, AL20, AL03,
AL54, AL55, AF73,
AF88: A.T.A. SRL
240006:
ELETTROBAR
1037308800:
MARENO
DEV3S: COLGED
B100,B303,CF35,CF4
0:

ADLER S.P.A.
3306510: LASA SRL
926035:
BRICE ITALIA SRL
RFO0A581:
EURFRIGOR



1124183 EL.VALV.
H2O S.LT.0,5 -220/50
1VIA 90° /
SOLENOID VALVE 1
WAY 90° H2O LT.0,5
220/50

23497: BREMA ICE
N23497: N.T.F. SRL



1124006 ELETTR
VALVOLA 1 VIA 90°
1,2L /
SOLENOID VALVE 1
WAY BREMA

68023001:

RANCILIO

23001: BREMA ICE

926132: BRICE

ITALIA



1124179 ELETTR
VALVOLA 1 VIA 90°
230V 1,2L /
SOLENOID VALVE 1
WAY 90° 230V 1,2L



1124151 ELETTR
VALVOLA 1V-
90°220/240 16mm /
SOLENOID VALVE 1
WAY 90° 220/240
16mm



1124363 ELETTR
VALVOLA 1 VIA 220V
90° D.10,5 BASSA
TEMPERATURA /
SOLENOID VALVE 1
WAY 90° D. 10,5 230V
LOW TEMPERATURE



1124175 ELETTR
VALVOLA INGRESSO
ACQUA A 1 VIA /
SOLENOID VALVE 1
WAY

23220: BREMA ICE

RF000624: BRICE

1185003E:

MONDIAL

926034: BRICE

ITALIA



1124250 ELETTR
VALVOLA INGRESSO
ACQUA A 1 VIA 90° /
SOLENOID VALVE 1
WAY 90°

23623: BREMA ICE



1124347 ELETTR
VALVOLA 1 VIA 8 LT.
220/50-60 /

SOLENOID VALVE 1

VIA 8 LT. 220 / 50-60

23819: BREMA ICE



1124173 ELETTR
VALVOLA 1 VIA
LT0,8 220/50-60-UL /
SOLENOID VALVE 1
WAY LT0,8 220/50-60-
UL

G500A: BREMA ICE

K01212: ARISTARCO



1124346 ELETTR
VALVOLA /
SOLENOID VALVE
62021301:

SCOTSMAN ICE

SRL



1124232 ELETTR
VALVOLA INGRESSO
ACQUA A 1 VIA /
SOLENOID VALVE 1
WAY

23787:

BREMA ICE MAKERS



1124064 ELETTR
VALVOLA 1 VIA 90°
D.10,5 24V /
SOLENOID VALVE 1
WAY 90° D. 10,5 24V

0L0175:

ELECTROLUX

0H2513:

ELECTROLUX



1124030 ELETTR
VALVOLA 1 VIA 90°
D.13,5 /
SOLENOID VALVE 1
WAY 90° D. 13,5



1124155 ELETTR
VALVOLA ELBI 1VIA
90° 230V 13,5 /
SOLENOID VALVE 1
WAY 90° 230V D.13,5
ELBI



1124086 ELETTRICO
VALVOLA 1 VIA D.
13,5 90° 24V /
SOLENOID VALVE 1
WAY D. 13,5 90° 24V

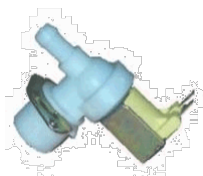

1124111 ELETTRICO
VALVOLA 1 VIA 90°
D.13,5 24V /
SOLENOID VALVE 1
WAY 90° D. 13,5 24V



1124327 Elettrovalvo
la ingresso acqua a 1 via
110V /
Solenoid water inlet 1
outlet 110V



23410:
BREMA ICE MAKERS

1124009 ELETTRICO
VALVOLA 2 VIE 90°
D. 10,5 /
SOLENOID VALVE 2
WAYS 90° D. 10,5

RF000625:
EURFRIGOR
120142:
COMENDA ALI
AL30, AL40, AL35,
AL45, AL50, AL60,
AL11, AL21, AL15,
AL25, AL54D,
AL55D, AF61, AF78,
AL16, AL26, AL05,
AL40/46/05-D:
A.T.A. SRL
B100, B303, CF35,
CF40: ADLER S.P.A.



1124191 EL.
VALVOLA H20 D. LT
0,8/0,8 /
SOLENOID VALVE
H20 D. LT 0,5/0,5
SL35: N.T.F. SRL
CB184: BREMA ICE
926137: BRICE
ITALIA



1124159 ELETTRICO
VALVOLA INGRESSO
ACQUA A 2 VIE
0,8/0,8 L AL MINUTO /
SOLENOID VALVE 2
WAYS 0,8/0,8 L
23116: BREMA ICE
K01045:
ARISTARCO



1124004 ELETTRICO
V. 2 VIE 23010 /
SOLENOID VALVE 2
WAYS ICEBOX
BREMA
926133:
BRICE ITALIA
23010: BREMA ICE



1124125 ELETTRICO
VALVOLA DOPPIA
BREMA 23542 /
DOUBLE SOLENOID
VALVE BREMA 23542
23542:
BREMA ICE MAKERS



1124212 ELETTRICO
VALVOLA INGRESSO
ACQUA A 2 VIE /
SOLENOID VALVE 2
WAYS
23502:
BREMA ICE MAKERS



1124278 ELETTRICO
VALVOLA INGRESSO
ACQUA A 2 VIE /
SOLENOID VALVE 2
WAYS
23501:
BREMA ICE MAKERS



1124324 Elettrovalvo
la ingresso acqua a 2 vie
1,2/1,2 lt /
SOLENOID VALVE 2
WAYS
23646: BREMA ICE
23261: BREMA ICE



1124196 ELETTRICO
VALVOLA INGRESSO
ACQUA A 2 VIE /
SOLENOID VALVE 2
WAYS
23157: BREMA ICE
926118:
BRICE ITALIA

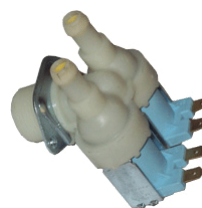

1124365 ELETTRICO
VALVOLA DUE VIE
230V 90° D.10,5
BASSA
TEMPERATURA /
SOLENOID VALVE 2
WAYS 90° D. 10,5
230V LOW
TEMPERATURE



1124066 ELETTRICO
V. 2 VIE 90° D.10,5
24V /
SOLENOID VALVE 2
WAYS 90° D. 10,5 24V

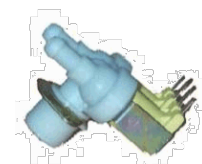

1124033 ELETTRICO
VALVOLA 2 VIE 90°
D. 13,5 /
SOLENOID VALVE 2
WAYS 90° D. 13,5

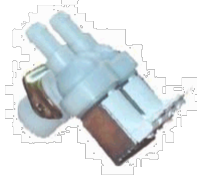

1124154 ELETTRICO
VALVOLA 2VIE 90°
230V D.13,5 ELBI /
SOLENOID VALVE 2
WAYS 90° 230V D.13,5
ELBI



1124036 ELETTRICO
VALVOLA 1 VIA 180°
D.10,5 /
SOLENOID VALVE 1
WAY 180° D. 10,5

CEEV1: OMNIWASH
2709000: MARENO
34040022:

RANCILIO
902390: SILANOS
4267: MACH

REB240011: COLGED
CF35,CF40: ADLER
D240011: GIGA

DW10703: DIHR
R65110010: LAINOX
26629: HOONVED

0300025: LAMBER
23120021: ELFRAMO
120173: HOONVED

MA2709000:
MARENO

240016:

ELETTROBAR

843101: TEIKOS SRL



1124182 ELETTRICO
VALVOLA INGRESSO
ACQUA 180° D.10,5
1,2L /
SOLENOID VALVE 1
WAY 180° D. 10,5 1,2L

CM19865518:

SCOTSMAN ICE
SRL

65010560:

SCOTSMAN

65010566:

SCOTSMAN

65010550:

SCOTSMAN

CM19865518:

CASTEL MAC SPA



1124042 VAL.EN.
H2O 220-240 IEN.3/4
D10 /
WATER ENTRY
SOLENOID VALVE
H2O 220-240 1 WAY
3/4 D. 10

Z1ID003:



SCOTSMAN

65010554:

SCOTSMAN

CM19865502/0:

CASTEL MAC SPA

1124293 ELETTRICO
VALVOLA SINGOLA
DRITTA 220-240V 3/4 /
WATER INLET
VALVE 220V-240V 3/4

65010564:

SCOTSMAN ICE

SRL



1124337 WATER
INLET VALVE /
WATER INLET
VALVE

65010574:

SCOTSMAN ICE

SRL



1124321 ELETTRICO
VALVOLA SEMPLICE
1DR025 /
SOLENOID VALVE
SIMPLE 1DR025

1DR025: MIGEL

S.R.L.



1124226 ELETTRICO
VALVOLA 220V 50-
60Hz /
SOLENOID VALVE
220V 50-60Hz

80002DR025: MACH

2DR025: MIGEL

S.R.L.



1124364 ELETTRICO
VALVOLA 1 VIA 220V
180° D. 10,5 BASSA
TEMPERATURA /
SOLENOID VALVE 1
WAY 180° D. 10,5
230V LOW
TEMPERATURE



1124252 SOLENOID
/

SOLENOID

65010503:

SCOTSMAN ICE

SRL



1124063 ELETTRICO
V. 1 VIA 180° D.10,5
24V /
SOLENOID VALVE 1
WAY 180° D. 10,5 24V

*: OMNIWASH SRL

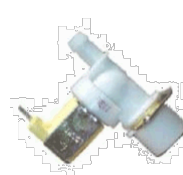

1124200 ELETTRICO
VALVOLA 180° 24V
DC /
SOLENOID VALVE
180° 24V DC



1124031 ELETTRICO
VALVOLA 1 VIA 180°
D.13,5 /
SOLENOID VALVE 1
WAY 180° D. 13,5
DW30001000: DIHR
3106180:
WINTERHALTER



1124172 ELETTRICO
VALVOLA 1 VIA 180°
230V D.13,5 ELBI /
SOLENOID VALVE 1
WAY 180° 230V D.13,5
ELBI



1124037 ELETTRICO
VALVOLA 1 VIA 180°
24V d.13,5 /
SOLENOID VALVE 1
WAY 180° 24V

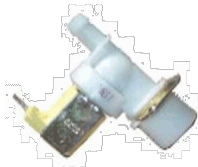

1124168 ELETTRICO
VALVOLA DOPPIA
180° D.10,5 ELBI 230V
/
SOLENOID VALVE 2
WAYS 180° D.10,5
ELBI 230V
9041010:
GRUPPO CIMBALI
SPA
977092000:
GRUPPO CIMBALI
SPA



1124008 ELETTRICO
VALVOLA 2 VIE 180°
D.10,5 /
SOLENOID VALVE 2
WAYS 180° D. 10,5
120146: COMENDA
843103: TEIKOS
SRL
*: MBM- EUROTEC
SRL
240003:
ELETTROBAR
34040021:
RANCILIO
CEEV2: OMNIWASH
902400: SILANOS
DEV3D: COLGED
1573: MACH
DW15098: DIHR-ALI
D240003: GIGA



26631: HOONVED
03000056: LAMBER
3300500: LASA SRL
R65110040-R65115:
LAINOX ALI SPA
23120001: ELFRAMO
049230:
ELECTROLUX
929172:
ELETTROBAR
425311034:
GICO SPA

1124084 ELETTRICO
VALVOLA DOPPIA X
SIMAG /
DOUBLE SOLENOID
VALVE FOR SIMAG
CM19865530:
SCOTSMAN ICE
819865530:
GRUPPO CIMBALI
SPA
CM19865530/0:
CASTEL MAC SPA
19865530:
SIMAG SPA



1124213 VALVE /
VALVE
Z1CW030:
SIMAG SPA
Z1CW030:
SCOTSMAN ICE

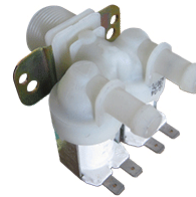

1124207 WATER
SOLENOID VALVE /
WATER SOLENOID
VALVE
65010553:
SCOTSMAN ICE
SRL



1124208 VALVE
ASSY /
VALVE ASSY
65010557:
SCOTSMAN ICE
SRL



1124114 VALVOLA
ENTRATA ACQUA /
WATER IN VALVE
65010570:
SIMAG SPA
*: SCOTSMAN ICE
889125079:
GRUPPO CIMBALI
65010562*:
SCOTSMAN ICE
65010551*:
SCOTSMAN ICE
SRL

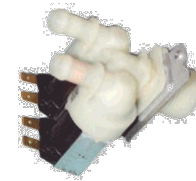

1124366 ELETTRICO
VALVOLA 2 VIE 230V
180° D.10.5 BASSA
TEMPERATURA /
SOLENOID VALVE 2
WAYS 180° D. 10,5
230V LOW
TEMPERATURE



1124065 ELETTRICO
VALVOLA 2 VIE 180°
D.10,5 24V /
SOLENOID VALVE 2
WAYS 180° D. 10,5
24V



1124032 ELETTRICO
VALVOLA 2 VIE 180°
D.13,5 /
SOLENOID VALVE 2
WAYS 180° D. 13,5
DW3000101:
DIHR-ALI SPA
3106182:
WINTERHALTER



1124210 ELETTRICO
VALVOLA 2 VIE 180°
D.13,5 ELBI /
SOLENOID VALVE 2
WAYS 180° D.13,5
ELBI



1124099 ELETTRICO
VALVOLA 3 VIE 90°
D. 10,5 /
SOLENOID VALVE 3
WAYS 90° D. 10,5
AL31, AL42, AL36,
AL46, AL16, AL26,
AF61DPS, AF78DPS:
A.T.A. SRL
120179:
COMENDA ALI SPA
26632:
HOONVED - ALI



1124035 ELETTRICO
VALVOLA 3 VIE 90°
D.13,5 /
SOLENOID VALVE 3
WAYS 90° D. 13,5



1124010 ELETTRICO
VALVOLA 3 VIE 180°
D. 10,5 /
SOLENOID VALVE 3
WAYS 180° D. 10,5
34040020:
RANCILIO SPA
902410: SILANOS
SRL
CEEV3:



OMNIWASH SRL
DEV3T: COLGED
1195: MACH
18010079:
NUOVA
SIMONELLI SPA
DW15099:
DIHR-ALI SPA
3305000: LASA SRL
120175:
COMENDA ALI SPA

1124124 ELETTRICO
VALVOLA A 3 VIE
180° COMENDA /
SOLENOID VALVE 3
WAYS 180°
COMENDA
*: COMENDA ALI
SPA



1124195 ELETTRICO
VALVOLA 3 VIE
23144/1 /
SOLENOID VALVE 3
WAYS 23144/1
23144/1:
BREMA ICE MAKERS
SPA
23144:
BREMA ICE MAKERS
SPA



1124034 ELETTRICO
VALVOLA 3 VIE 180°
D.13,5 /
SOLENOID VALVE 3
WAYS 180° D. 13,5



1124214 ELETTRICO
V.2VIE.APERTA4/CHI
USA2 220/50-60 /
SOLENOID VALVE 2
WAYS 220/50-60
23138:
BREMA ICE
N23138: N.T.F. SRL



1124194 VALVOLA
DOPPIA ED90/88 BP 1
LIB. /
SOLENOID VALVE 2
WAYS ED90/88 BP 1
LIB.
RF000690:
EURFRIGOR SRL
*: BRICE ITALIA
SRL
*: EURFRIGOR ICE
MAKERS SRL



1124043 VAL.EN.
H20 220-240 IEN. 3/4
2U /
WATER ENTRY
SOLENOID VALVE
H20 220-240 1WAY IN
3/4 2WAYS OUT
AL31, AL36, AL41,
AL46: A.T.A. SRL
CM19865509/O:
CASTEL MAC SPA
CM19865509:
SCOTSMAN ICE
SRL
Z1CW029:
SCOTSMAN ICE
SRL

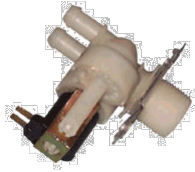

1124098 BOBINA
ELETTRORVALVOLA
LT 220V /
SOLENOID VALVE
COIL LT 220V
630969:
COMENDA ALI SPA

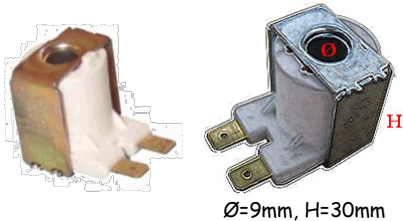

Ø=9mm, H=30mm

1124367 BOBINA
ELETTRORVALVOLA
BASSA
TEMPERATURA 220V
/
SOLENOID VALVE
COIL FOR COLD 220V

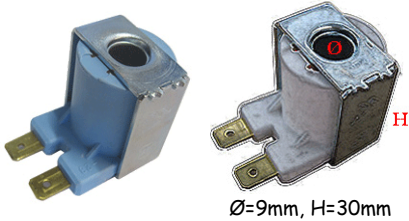

Ø=9mm, H=30mm

1124069 BOBINA
ELETTRORVALVOLA
24V AC /
SOLENOID VALVE
COIL 24V AC

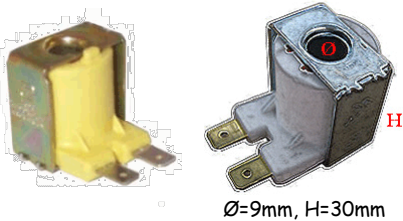

Ø=9mm, H=30mm

1124150 BOBINA
24V AC /
COIL 24V AC

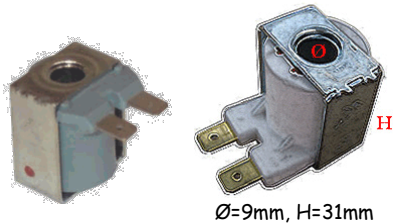

Ø=9mm, H=31mm

1124192 BOBINA
24V CC /
SOLENOID VALVE
COIL 24V CC

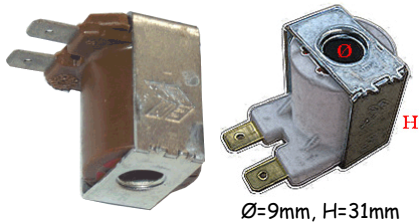

Ø=9mm, H=31mm

1124071 REGOLAT
ORE USCITA 0,25L.
ROSSO /
RED DEBIT
REGULATOR 0,25L.
Z1ID002: SIMAG
SPA



1124176 RIDUTTOR
E FLUSSO 0,25 L/MIN
VERDE ELBI /
GREEN DEBIT
REGULATOR
0,25LT/MIN ELBI
64002201:
SCOTSMAN ICE
SRL



1124073 REGOLAT
ORE USCITA 0,5L.
ARANCIO /
ORANGE DEBIT
REGULATOR 0,5L.
10558: ADLER S.P.A.
401200500:
STAFF ICE SYSTEM
SRL
4167-3306500:
LASA SRL



1124201 REGOLAT
ORE DI USCITA ELBI
0,5 LT/MIN /
DEBIT REGULATOR
ELBI 0,5 LT/MIN



1124211 REGOLAT
ORE DI USCITA 0,8
LT/H BIANCO /
DEBIT REGULATOR
0,8 LT/H



1124072 REGOLAT
ORE USCITA 1,2L.
MARRONE /
BROWN DEBIT
REGULATOR 1,2L.
4012006000:
STAFF ICE SYSTEM
SRL
65010520:
SCOTSMAN ICE
SRL
*: MBM- EUROTEC
SRL - DIV.
COOKING SERVICE



1124237 RIDUTTOR
E DI PORTATA ELBI
1,2L/MIN BIANCO /
WHITE DEBIT
REGULATOR ELBI 1,2
L/M



1124137 RIDUTTOR
E DI PORTATA 2 LT
ELBI /
DEBIT REGULATOR 2
LT ELBI



1124074 REGOLAT
ORE USCITA 2,5L.
GIALLO /
YELLOW DEBIT
REGULATOR 2,5L.

*: **MBM- EUROTEC**
SRL - DIV.
COOKING SERVICE

RF000702:

EURFRIGOR ICE
MAKERS SRL

4012008000:

STAFF ICE SYSTEM
SRL

65010521:

SCOTSMAN ICE
SRL

172833:

MBM- EUROTEC SRL
- DIV. COOKING
SERVICE



1124222 RIDUTTOR
E DI PORTATA IN
USCITA 2,5L/MIN /
DEBIT REGULATOR
2,5L/MIN



1124075 REGOLAT
ORE USCITA 3L.
VERDE /
GREEN DEBIT
REGULATOR 3L.



1124236 RIDUTTOR
E DI PORTATA ELBI
4,7 L/MIN BIANCO /
WHITE DEBIT
REGULATOR ELBI 4,7
L/M



1124076 REGOLAT
ORE USCITA 5L.
NERO /
BLACK DEBIT
REGULATOR 5L.

Z1CW022:

SIMAG SPA

650100522:

SCOTSMAN ICE
SRL

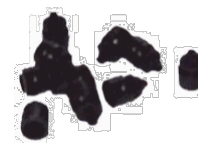

1124209 RIDUTTOR
E DI PORTATA IN
USCITA 5,5 LT/MIN /
DEBIT REGULATOR
5,5 LT/MIN



1124126 RIDUTTOR
E FLUSSO 1,8LT/MIN /
DEBIT REGULATOR
1,8LT/MIN

64002200:

SCOTSMAN ICE
SRL



1124128 CONTROL
LO DI FLUSSO D. 1,5 /
DEBIT REGULATOR
D. 1,5

64002202:

SCOTSMAN ICE
SRL



1124138 RIDUTTOR
E DI PORTATA
2,5LTM
/ DEBIT REGULATOR
2,5LTM

64002203:

SCOTSMAN ICE
SRL



1124206 RIDUTTOR
E DI PORTATA
5,5L/MIN /
DEBIT REGULATOR
5,5L/MIN



1124318 RIDUTTOR
E DI PORTATA IN
INGRESSO ELBI
12LT/MIN /
REDUCING FLOW
INLET ELBI 12LT/MIN



1124255 RIDUTTOR
E DI PORTATA IN
INGRESSO 16 LT/MIN
/
DEBIT REGULATOR
16 LT/MIN



1124048 CORPO
VALVOLA INV.
CICLO 246 / CYCLE
REVERSAL
SOLENOID VALVE
BODY 246

CB316:

BREMA ICE
MAKERS SPA

087965:

ELECTROLUX
PROFESSIONAL

S.P.A.

920026:

BRICE ITALIA SRL



coil= 1124012

1124158 CORPO
VALVOLA
INVERSIONE CICLO /
CYCLE REVERSAL
SOLENOID VALVE
BODY

20409:

BREMA ICE MAKERS
SPA



1124290 CORPO
VALVOLA
INVERSIONE CICLO /
SOLENOID VALVE
BODY

20853:

BREMA ICE MAKERS
SPA

920025:

BRICE ITALIA SRL



1124188 ELETTO
VALVOLA GAS-
CALDO /
WARM GAS VALVE

CM19863038/0:

CASTEL MAC SPA



1124189 VALV.LIM
ITATRICE KVL 28
DANFOSS 34L0051
ATT. ODF /
VALVE KVL 28
DANFOSS 34L0051
ATT. ODF

CM19870505/0:

CASTEL MAC SPA



1124230 HOT GAS
VALVE BODY /
HOT GAS VALVE
BODY

62030607:

SCOTSMAN ICE
SRL



1124313 LIQUID
LINE SOLENOID
BODY /
LIQUID LINE
SOLENOID BODY

IOM915112302:

SCOTSMAN ICE
SRL



1124315 CORPO
VALVOLA GAS
CALDO /
HOT GAS VALVE
BODY ONLY

IOM915112301:

SCOTSMAN ICE
SRL



1124184 HOT GAS
VALVE BODY /
HOT GAS VALVE
BODY

CMCF62030622:

CASTEL MAC SPA
62030622:

SCOTSMAN ICE
SRL



1124233 HOT GAS
VALVE BODY /
HOT GAS VALVE
BODY

62030627:

SCOTSMAN ICE
SRL



COIL=1124162

1124242 HOT GAS
VALVE BODY /
HOT GAS VALVE
BODY

62030614:

SCOTSMAN ICE
SRL



1124265 VALVOLA
GAS CALDO
PASSAGGIO
DIRETTO 1/4" SAE
CASTEL /
"HOT GAS VALVE
1/4" SAE CASTEL"

1020/2A6: CASTEL

1020/2A6:

BRICE ITALIA SRL



1124267 VALVOLA
GAS CALDO
PASSAGGIO
INVERSO 3/8" SAE
CASTEL /
"HOT GAS VALVE
3/8"" SAE CASTEL"
1020/3A6: **CASTEL**
1020/3A6:
BRICE ITALIA SRL



1124319 VALVOLA
GAS 1068/M10 /
GAS VALVE 1068/M10
CM198630340:
CASTEL MAC SPA



1124243 HOT GAS
VALVE /
HOT GAS VALVE
CM19863034:
**SCOTSMAN ICE
SRL**



1124198 HOT GAS
VALVE 24V SVCS /
HOT GAS VALVE 24V
SVCS
*: **SCOTSMAN ICE
SRL**
1200247102:
**SCOTSMAN ICE
SRL**



1124268 SOLENOID
LIQUID VALVE /
SOLENOID LIQUID
VALVE
1200227401:
**SCOTSMAN ICE
SRL**



1124216 VALVOLA
SOLENOIDE 5925 DN
1,5 R404-CEME* /
SOLENOID VALVE
5925 DN 1,5 R404-
CEME
926091+920025:
BRICE ITALIA SRL
RF000531:
EURFRIGOR SRL
RF000532:
EURFRIGOR SRL
926082:
BRICE ITALIA SRL

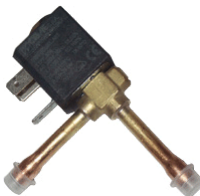

coil=1124282,
Body=1124290

1124266 VALVOLA
GAS CALDO
PASSAGGIO
DIRETTO 1/4" ODF
CASTEL /
"HOT GAS VALVE
1/4"" ODF CASTEL"
1028/2A6:



BRICE ITALIA SRL

1124277 VALVOLA
SOLENOIDE+BOBINA
6807 DN2,5 CEME /
SOLENOID
VALVE+COIL 6807
DN2,5 CEME
RF00B770:
EURFRIGOR SRL
926084:
BRICE ITALIA SRL



4114565 VALVOLA
VE117 2CLS ZB09 /
VALVE VE117 2CLS
ZB09
1RF123: **MIGEL
S.R.L.**



4127211 VALVOLA
SOLENOIDE /
SOLENOID VALVE
1RF185
: **MIGEL S.R.L.**
1RF014EX:
MIGEL S.R.L.



1124170 HOT GAS
VALVE ASSY /
HOT GAS VALVE
ASSY
CM19863033:
**SCOTSMAN ICE
SRL**
CM19863033/0:
CASTEL MAC SPA



1124156 BOBINA
PARKER YB09 220-
230V 50-60Hz 9W /
COIL PARKER YB09
*: **CASTEL MAC SPA**

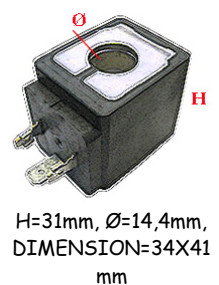

1124162 BOBINA
VALVOLA GAS
CALDO - YB14 220-
230V 50-60Hz 14W /
HOT GAS VALVE
COIL
CMCF62030648:
CASTEL MAC SPA
62030648:
**SCOTSMAN ICE
SRL**

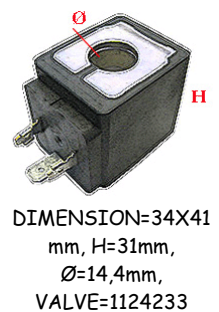

1124080 CONNETT
ORE RETTANG. X
SERIE 30 /
RECTANGULAR
CONNECTOR FOR
SET 30



BOBINA=1124093

1124081 CONNETT
ORE QUADRATO X
SERIE 30 /
SQUARE
CONNECTOR FOR
SET 30



1124012 BOBINA
GAS CALDO HM2
220-230V 50-60Hz 8W /
WARM GAS COIL

K01101:

ARISTARCO

CASTEL

23091:

BREMA ICE MAKERS

085289:

ELECTROLUX

926092:

BRICE ITALIA SRL

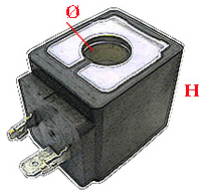

DIMENSIONS
34X45mm, H=35mm,
Ø=11,6mm,
VALVE= 1124048

1124258 HOT GAS
VALVE COIL-CASTEL

HOT GAS VALVE
COIL-CASTEL

06068900:

SCOTSMAN ICE

SRL



1124148 BOBINA
NC 220V /
SOLENOID VALVE
COIL 220V



H=50mm, Øi=14,3mm,
Øb=36mm

1124282 BOBINA X
VALV. SOL. CEME
5925 DN 1,5 220V /
SOLENOID VALVE
COIL CEME 5925 DN
1,5

RF00B540:

EURFRIGOR SRL

926091:

BRICE ITALIA SRL

23854:

BREMA ICE MAKERS

SPA



H=28mm, Ø=12mm,
DIMENSION=33X41
mm

1124264 BOBINA A
FASTON 230-50HZ
DB2 /
SOLENOID COIL 230-
50HZ DB2

201002:

ELETTROBAR
DIVISIONE DELLA
EUROTEC SRL

*: MBM- EUROTEC
SRL - DIV.

COOKING SERVICE



1124094 BOBINA
220V TANDEM /
COIL 220V TANDEM

967090: SIT SPA



1124281 BOBINA
220/240V ORIENTATA
ALTO /
SOLENOID VALVE
COIL 220/240V

0967066: SIT SPA



H=40mm, Ø=9,3mm,
DIMENSIONS
25X47mm

1124245 ELETTO
VALVOLA SCARICO
ACQUA /
"SOLENOID VALVE
SINGLE ELBOW 230V
?" ?11,5mm WITH
CABLE 600mm"

23537:

BREMA ICE MAKERS
SPA

N23537: N.T.F. SRL



1124116 KIT
ELETTOVALVOLA
SCARICO /
DRAIN SOLENOID
VALVE KIT

62046000:

SCOTSMAN ICE
SRL

06056400:

SCOTSMAN ICE
SRL

62040601:

SCOTSMAN ICE
SRL



1124289 VALVE
INLET /
VALVE INLET

1200143405:

SCOTSMAN ICE
SRL



1124303 GRUPPO
VALVOLA
DEVIATR.CON
RIDUTTORE /
VALVE WITH
REDUCER
999288:
ELETTOBAR
DIVISIONE DELLA
EUROTEC SRL



1124246 VALVE
PURGE /
VALVE PURGE
1100051401:
SCOTSMAN ICE
SRL



1124197 PURGE
VALVE /
PURGE VALVE
1100051402:
SCOTSMAN ICE
SRL

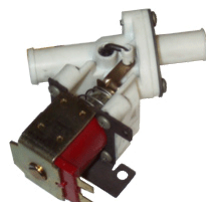

1124199 SOLENOID
24V S/53 /
SOLENOID VALVE
24V S/53
1200254801:
SCOTSMAN ICE
SRL



1124298 INLET
WATER SOL. VALVE
/
INLET WATER SOL.
VALVE
1200292202:
SCOTSMAN ICE
SRL

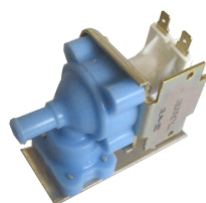

1124299 WATER
INLET
VALVE12244606 /
WATER INLET
VALVE12244606
1200244626:
SCOTSMAN ICE
SRL

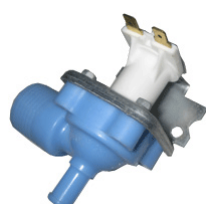

1124300 WATER
IN. VALVE /
WATER IN. VALVE
1200266601:
SCOTSMAN ICE
SRL



1124343 SPRING
STEEL DRIVE FOR
DISHWASHER /
SPRING STEEL
DRIVE FOR
DISHWASHER
1200164605:
SCOTSMAN ICE
SRL



1124186 VALV.SCA
RICO ACQUA 220-
240V/50 ATT.D14
BASSA PRESS /
WATER DRAIN
SOLENOID VALVE
220-240V/50
RECOC508:
EURFRIGOR SRL

II19865525:
GIGA GRANDI
CUCINE SRL
CM19865525/0ex:
CASTEL MAC SPA
19865525/0:
SCOTSMAN ICE
SRL
CM81454760/0:
CASTEL MAC SPA
CM81454760:
SCOTSMAN ICE
SRL
CM814547600:
CASTEL MAC SPA
CM198655250ex:
CASTEL MAC SPA



1124089 VALVOLA
DI SCARICO 24V ATA
/
DRAIN SOLENOID
VALVE 24V ATA
13102: A.T.A. SRL



1124296 "VALVOL
A MOTORIZZATA;
3/4" 230V 50/60HZ" /
BALL-TAP 3/4" 230V
50/60HZ"
OC0882:
ELECTROLUX
PROFESSIONAL
S.P.A.



1124297 VALVOLA
DI SCARICO /
DRAIN VALVE
OW2055:
ELECTROLUX
PROFESSIONAL
S.P.A.



1124257 WATER
DRAIN VALVE /
WATER DRAIN
VALVE

1100056402:
SCOTSMAN ICE
SRL
CM198655400:
CASTEL MAC SPA
CM19865540:
SCOTSMAN ICE
SRL



1124110 VALVOLA
MAGNETICA DI
SCARICO 220V/50HZ /
DRAIN MAGNETIC
SOLENOID VALVE
220V 50HZ

3106045:
WINTERHALTER
ITALIA SRL



1124310 ELETTR
V.I VIA
B.PRESS.F.GAS /
SOLENOID VALVE 1
WAY LOW
PRESSURE. GAS

EB01800:
OEM ALI SPA



1124256 HARVEST
ASS.SOLENOID ASSY
/

HARVEST
ASS.SOLENOID ASSY
CM81454259:
SCOTSMAN ICE
SRL



1124350 ASSIEME
ELETTROMAGNETE
CONTENITORE /
HARVEST
ASS.SOLENOID ASSY

CM81455072:
SCOTSMAN ICE
SRL



1124133 VALVOLA
GALLEGGIANTE /
FLOATER VALVE

10188:
BREMA ICE MAKERS
SPA
N10188: N.T.F. SRL



1124229 VALVE
ASSY (RESERVOIR) /
VALVE ASSY
(RESERVOIR)

0200221702:
SCOTSMAN ICE
SRL
CM19864011/0:
CASTEL MAC SPA



1124262 FLOAT
VALVE /
FLOAT VALVE

IOM913111101:
SCOTSMAN ICE
SRL
IOM9131111101:
SCOTSMAN ICE
SRL



1124294 ASSIEME
VALVOLA NON
RITORNO /
BACK FLOW
RESTRICTOR
DISHWASHER

2376:
ARISTARCO
KASTEL SPA



1124219 VALVOLA
DI NON RITORNO /
NON RETURN VALVE

30603:
SISTEMA PROJECT
SERVICE SRL



1124338 VALVOLA
SOLENOIDE /
SOLENOID VALVE

0W2063:
ELECTROLUX
PROFESSIONAL
S.P.A.



1124314 ALCO
COIL ONLY 230V /
ALCO COIL ONLY
230V

IOM915112304:
SCOTSMAN ICE
SRL



1124340 ELETTR
VALVOLA 084013 /
SOLENOID VALVE
084013

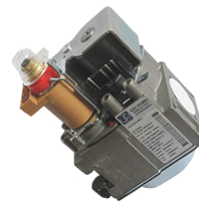

1124305 RESTRITT
ORE DI FLUSSO DEL
RUBINETTO /
Flow restrictor TAP

2280024900:
UGOLINI SPA



1124231 AUT. EXP.
VALVE /
AUT. EXP. VALVE
62042757:
SCOTSMAN ICE
SRL



1128006 CAVO CON
SPINA STAMP.
SCHUKO 3X1 MT2 /
CABLE WITH PLUG
SCHUKO 3X1 MT2



1128007 CAVO CON
SPINA SCHUKO 3X1,5
- 2000mm /
CABLE WITH PLUG
SCHUKO 3X1,5 -
2000mm



1127002 PALETTA
AGITATORE
ICEMATIC /
MIXER ARM
ICEMATIC
25545520/2:
CASTEL MAC SPA
CM25545520:
SCOTSMAN DIV.
FRIMONT SPA



1127006 PALETTA
AGITATORE
COSMETAL
/ MIXER ARM
COSMETAL
2781336:
COSMETAL SRL
25545509/0:
CASTEL MAC SPA
25545509/0:
VEGA DIV. DELLA
CASTEL MAC SPA



1127003 PALETTA
AGITATORE TIPO
STRETTO /
MIXER ARM
NARROW TYPE
910001:
BRICE ITALIA SRL
RH000675:
EURFRIGOR ICE
MAKERS SRL



1127008 PALETTA
AGITATORE ITV /
MIXER ARM ITV
20-30: I.T.V. S.A.



1127010 AGITATO
RE KP20/30/40 /
SHAKER KP 20/30/40
1CD089:
MIGEL S.R.L.



4114332 ALBERO
PALETTE N EC
20/30/30S/40 /
PADDLE SHAFT N
EC20/30/30S/40
RQ00A029:
EURFRIGOR ICE
923003:
BRICE ITALIA SRL
RQ00A029:
EURFRIGOR SRL



4114820 ALBERO
PALETTE N EC 130 /
PADDLE SHAFT N EC
130
923007:
BRICE ITALIA SRL
RQ00A063:
EURFRIGOR SRL



DIAMETER= 6 mm,
LENGTH= 742 mm

4122402 RQ00A075-
ALBERO PALETTE N
EC 80-ECF 90 /
RQ00A075- TREE
PADDLE N EC 80-E 90
923008:
BRICE ITALIA SRL



L=517mm, Ø=6mm

4114023 ALBERO
PALETTE N /
PADDLE SHAFT N5
25084535/0:
CASTEL MAC SPA



DIAMETER = 6 mm,
LENGTH= 308 mm

4114135 ALBERO
PALETTE N12-22 /
PADDLE SHAFT N12-
22
25085011/0:
CASTEL MAC SPA



DIAMETER= 6 mm,
LENGTH= 740 mm

4114034 ALBERO
PALETTE N20 /
PADDLE SHAFT N20
CM25030006
: SCOTSMAN DIV.
FRIMONT SPA
25030022/0:
CASTEL MAC SPA

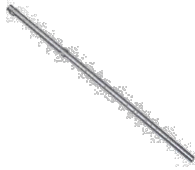

DIAMETER= 6 mm,
LENGTH= 166 mm

4114154 ALBERO
PALETTE N20 /
PADDLE SHAFT N20



4114777 ALBERO
BACINELLA N25 /
PADDLE SHAFT N25
25030021/0:
CASTEL MAC SPA



4114033 ALBERO
PALETTE N30 /
PADDLE SHAFT N30
25030007:
CASTEL MAC SPA
CM25030007:
SCOTSMAN DIV.
FRIMONT SPA

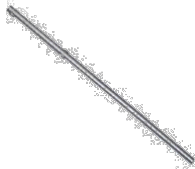

DIAMETER= 6 mm,
LENGTH= 206 mm

4114021 ALBERO
PALETTE N55 /
PADDLE SHAFT N55
CM25030010:
SCOTSMAN DIV.
FRIMONT SPA
25030010:
CASTEL MAC SPA

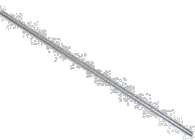

DIAMETER= 6 mm,
LENGTH= 316 mm

4114164 ALBERO
PALETTE N75 /
PADDLE SHAFT N75
CM25030011:
SCOTSMAN DIV.
FRIMONT SPA
25030011/0:
CASTEL MAC SPA



DIAMETER= 6 mm,
LENGTH= 496 mm

4114959 ALBERO
PORTA LX30-50 /
SHAFT FOR DOOR
LX30-50
CM25030019:
SCOTSMAN DIV.
250300190:
CASTEL MAC SPA



DIAMETER= 6 mm,
LENGTH= 358 mm

4122187 METAL
PIN /
METAL PIN
72421510:
SCOTSMAN DIV.
FRIMONT SPA



4122471 PERNO
SOSTEGNO PORTA N
12 /
PIN DOOR SUPPORT
N 12
CM25560285/0:
CASTEL MAC SPA



Ø= 6X885mm

4114740 ALBERO
CON PALETTE /
SHAFT WITH
PADDLE
20818:
BREMA ICE
MAKERS SPA



4114636 ALBERO
CON PALETTE /
PADDLE WITH
SHAFT
20389
BREMA ICE
MAKERS SPA

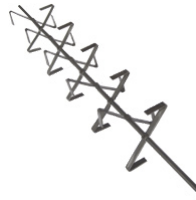

4114609 ALBERO
CON PALETTE /
PADDLE WITH
SHAFT
20822:
BREMA ICE
MAKERS SPA



4122098 RQ004110-
ALBERO PALETTE
COMPLETO EC 18 /
RQ004110-TREE
FULL PADDLE EC 18
AS928043:
BRICE ITALIA SRL



4114997 RQ004120-
ALBERO PALETTE
COMPLETO EC25/30 /
AS928044:
BRICE ITALIA SRL
RQ004120:
EURFRIGOR SRL



4122017 RQ004130-
ALBERO PALETTE
COMPLETO EC40-50 /
EC40-50 SHAFT
COMPLETE PADDLE
AS928045:
BRICE ITALIA SRL



L= 300 mm

4122005 RQ004150-
ALBERO PALETTE
COMPLETO EC130 /
RQ004150-TREE FULL
PADDLE EC130
AS928042:
BRICE ITALIA SRL



4122062 ASS.ALBE
RO PALETTE VEGA20
/
COMPLETE TREE
PADDLE VEGA20
81300007/0:
CASTEL MAC SPA



4114334 GR
ALB.CON 12
PALETTE MP100/150 /
ARM WITH 12
SHOVELS MP100/150
9070341000:
STAFF ICE SYSTEM
SRL



1127001 SESSOLA
PICCOLA ICE BOX /
SMALL SCOOP
ICEBOX
*****:
RANCILIO SPA
10016:
BREMA ICE
MAKERS



1127011 SESSOLA
L=220MM /
SCOOP L=220MM
10080:
BREMA ICE
MAKERS SPA



1127005 PALETTA
ICEMATIC /
SMALL SCOOP
ICEMATIC
CM19500100:
SCOTSMAN
19500100/0:
CASTEL MAC SPA



1127007 PALETTA
GRANDE MC15 ART.
560
/ SMALL SCOOP
MC15 ART. 560
65014600:
SCOTSMAN DIV.
FRIMONT SPA



4114444 ICE
SCOOP / ICE SCOOP
0200054001:
SCOTSMAN DIV.
FRIMONT SPA



1127009 AGITATO
RE MINILUX /
MINILUX MIXER
SL300006017:
GBG ALI SPA

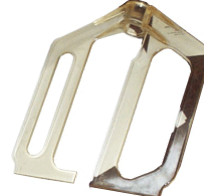

4122461 PALA IN
FIBRA /
SHOVEL IN FIBER
PALA IN FIBRA:
BREMA ICE
MAKERS SPA



L=995mm

4114408 ICE
SHOVELL /
ICE SHOVELL
ICE SHOVEL:
SCOTSMAN ICE
SRL



1129180 SONDA
TEMP. LIVELLO
GHIACCIO L1500 /
ICE LEVEL
TEMPERATURE
PROBE L1500
K04677:
ARISTARCO
K01473EX:
ARISTARCO
KASTEL



1129181 SONDA
TEMP.
EVAPORATORE
L2000 /
EVAPORATOR
TEMPERATURE
PROBE L2000
K01472EX:
ARISTARCO
KASTEL SPA
K04678:
ARISTARCO
KASTEL SPA



1129032 SONDA
LOGICA L=1200
C/BULBO /
LOGIC BORE L=1200
WITH BULB
CM33701015/0:
CASTEL MAC SPA

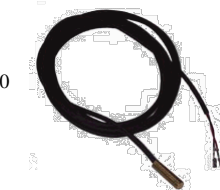

1129230 SONDA
TEMPERATURA
DEPOSITO GHIACCIO
E21...35 /
TEMPERATURE
PROBE STORAGE ICE
E21 ... 35

CM335802650:

CASTEL MAC SPA



1129283 SONDA
TEMPERATURA PTC
KTY 81-121 /
TEMPERATURE
PROBE PTC KTY 81-
121

CM33580099/1:

CASTEL MAC SPA



1129290 SONDA
TEMPERATURA NTC
1,5 M COD. FORNIT. 1
/

TEMPERATURE
PROBE NTC 1,5 M

CM33580115/0:

CASTEL MAC SPA



1129159 WATER
LEVEL SENSOR /
WATER LEVEL
SENSOR

CM29015055/0:

CASTEL MAC SPA

I62040404:

GIGA GRANDI

CUCINE SRL

62040404:

SCOTSMAN ICE

SRL

62040413:

SCOTSMAN ICE

SRL



1129293 "SONDA;
TYPE NTC22K;
L=1600MM" /
PROBE TYPE
NTC22K; L=1600MM

087959:

ELECTROLUX
PROFESSIONAL
S.P.A.



1129295 "SONDA;
6X40; GREEN;
L=1500MM;
SBRINAM." /
GREEN PROBE 6X40
L=1500MM

092178:

ELECTROLUX
PROFESSIONAL
S.P.A.



1129207 SONDA
TERMOSTATO
GRANITORE /
THERMOSTAT
PROBE

SL310002736:

GBG ALI SPA



1129176 SONDA X
ELIWELL NTC
L=1,5mt /
PROBE FOR ELIWELL
NTC L=1,5mt

BN167212:

HIBER - ALI S.p.A.

BN167212:

SILKO ALI SPA



1129171 SONDA
FOTOCELLULA
EMETTITORE TESTA
NERA /
PROBE

1LT065: MIGEL

S.R.L.



1129172 SONDA
FOTOCELLULA
RICEVITORE TESTA
TRASPARENTE /
RECEIVER PROBE

1LT066: MIGEL

S.R.L.



1129173 SONDA
TEMPERATURA
CONDENSATORE /
CAPACITOR
TEMPERATURE
PROBE

1LT067: MIGEL

S.R.L.



1129255 SONDA
PTC GRIGIA
SILICONE L=2500
CELLA /
GREY SILICON
SENSOR PTC L = 2500
CELL

FR995562:

POLARIS/BARON

ALI S.P.A.

167202:

OLIS DIVISIONE

FR995562: OLIS

FR995562:

LAINOX ALI SPA

FR995562:

SILKO ALI SPA



1129029 SONDA
EVAPORATORE
SCOTSMAN /
EVAPORATOR BORE
SCOTSMAN
MC 46:
SCOTSMAN ICE
SRL
086344:
ELECTROLUX
PROFESSIONAL
S.P.A.
CM29070013/0:
CASTEL MAC SPA

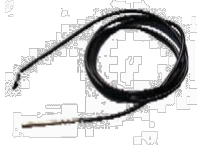

1129134 SONDA
CONDENSATORE /
CAPACITOR PROBE
62040401:
SCOTSMAN ICE
SRL
AC175, MC 46:
SCOTSMAN ICE
SRL
CMCF62040411:
CASTEL MAC SPA



1129229 SONDA
TEMP.CONDENS.MO
D.500 L=2150 /
CONDENSER SENSOR
MOD.500 L=2150
CM335801350:
CASTEL MAC SPA
CM33580135:
SCOTSMAN ICE
SRL



1129179 CONDENS
ER SENSOR /
CONDENSER SENSOR
CM33580101:
SCOTSMAN ICE
SRL



1129030 SONDA
CONTENITORE
SCOTSMAN /
CONTAINER BORE
SCOTSMAN
62040406:
SCOTSMAN ICE
SRL
086369:
ELECTROLUX



1129227 SONDA
EVAPORATORE /
SENSOR,
EVAPORATOR
62047501:
SCOTSMAN ICE
SRL



1129243 EVAPORA
TORSOR NTC /
EVAPORATORSENSOR
R NTC
62051901:
SCOTSMAN ICE
SRL
CM33580297/0:
CASTEL MAC SPA
CMCF62051901:
CASTEL MAC SPA



1129242 SENSORE
CONDENSATORE
NTC /
CONDENSER SENSOR
NTC
62051900:
SCOTSMAN ICE
SRL
CMCF62051900:
CASTEL MAC SPA
CM335802980:
CASTEL MAC SPA
62051903:
SCOTSMAN ICE
SRL



1129216 SENSORE
DI TEMPERATURA
SET /
TEMPERATURE
SENSOR SET
CM25702401:
SCOTSMAN ICE
SRL



1129298 CONDENS
ER SENSOR NTC /
CONDENSER SENSOR
NTC
62051904:
SCOTSMAN ICE
SRL



L=1700mm

1129299 SENSOR
ICE LEVEL /
SENSOR ICE LEVEL
0A03771021:
SCOTSMAN ICE
SRL



1129300 TEMPERA
TURE SENSOR /
TEMPERATURE
SENSOR
1100051521:
SCOTSMAN ICE
SRL



1129223 DUAL
PROBE ASSY /
DUAL PROBE ASSY
0200341021:
SCOTSMAN ICE
SRL



Ø=6,4X44,6mm

1129043 SENSORE
AMBIENTE /
ENVIRONMENT
BORE
62040402:
SCOTSMAN ICE
SRL

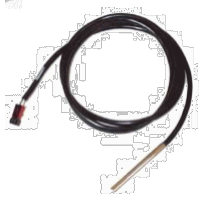

1129254 SENSORE
LIVELLO ACQUA /
WATER LEVEL
SENSOR
62051902:
SCOTSMAN ICE
SRL
CMCF62051902:
CASTEL MAC SPA



1129245 CAVO
COLLEGAMENTO
SENSORE LIVELLO
ACQUA /
WATER LEVEL
SENSOR HARNESS
CM81455102:
SCOTSMAN ICE
SRL



1129205 SONDA
PTC IN TPE STEEL
6X40 1,5MT /
PROBE PTC IN TPE
STEEL 6X40 1,5MT



1129047 SONDA
NTC6X40 1,5MT
SN8POA1500 /
PROBE NTC6X40
1,5MT SN8POA1500

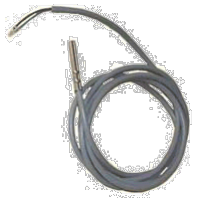

1129010 ASSIEME
SENSORE GHIACCIO
MV18 /
ICE PROBE MV18
RECOC540:
EURFRIGOR ICE
MAKERS SRL
CM81453114/0*:
CASTEL MAC SPA
CM81453434:
SCOTSMAN ICE
SRL
CM81453434/0:
CASTEL MAC SPA



RECOC540:
EURFRIGOR SRL

1129175 ASS.SENS
ORE LIVELLO
ACQUAMOD.450/600 /
PROBE FOR WATER
LEVEL 450/600
CM81453796:
SCOTSMAN ICE
SRL
CM81453590:
SCOTSMAN ICE
SRL
CM81453796/0:
CASTEL MAC SPA
CM814535900:
CASTEL MAC SPA

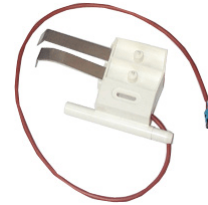

1129248 ASS.SENS.
LIVELLO H20 E21...35
/
WATER SONDE ASSY
CM81400044/0:
CASTEL MAC SPA

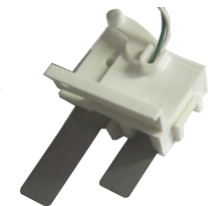

1129222 ASS.SENS.
LIVELLO ACQUA
PRODIGY
MOD.450...1000 /
LEVEL ELECTRODE
PRODIGY MOD.
450...1000
CM814550650:
CASTEL MAC SPA
CM814550650:
CASTEL MAC SPA



1129241 WATERLE
VELSENSOR /
WATERLEVELSENSO
R
0A03903021:
SCOTSMAN ICE
SRL



1129221 ICE
THICKNESS SENSOR
/
ICE THICKNESS
SENSOR
CM81455094:
SCOTSMAN ICE
SRL



1129231 WATER
LEVEL SENSOR /
WATER LEVEL
SENSOR
0A03903022:
SCOTSMAN ICE
SRL



1129284 ICE
SENSOR HOLDER /
ICE SENSOR HOLDER
0200368901:
SCOTSMAN ICE
SRL

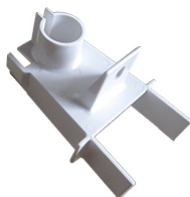

1129232 ICE
THICKNESS SENSOR
/
ICE THICKNESS
SENSOR
0A03903121:
SCOTSMAN ICE
SRL



1129155 SONDA
LIVELLO ACQUA
CME506 /
WATER LEVEL
PROBE CME506
110053921:
SCOTSMAN ICE
SRL



1129170 SENSOR
SUMP LEVEL ASSY /
SENSOR SUMP
LEVEL ASSY
1100053951:
SIMAG SPA
1100053951:
SCOTSMAN ICE
SRL



1129219 OPTICAL
CONTROL R /
OPTICAL CONTROL
R
62044802:
SCOTSMAN ICE
SRL



1129166 CURTAIN
SENSOR /
CURTAIN SENSOR
1200243622:
SCOTSMAN ICE
SRL



1129267 6334
SENSORE /
6334 SENSOR
106334: I.T.V. S.A.



1129144 SENSORE
LIVELLO X
GRANULARE
SCOTSMAN /
ICE LEVEL CTL.
SCOTSMAN
65067401:
SCOTSMAN ICE
SRL
65067402ex:
SCOTSMAN ICE
SRL



L=180mm

1129239 OPTICAL
ICE LEVEL CONTROL
/
OPTICAL ICE LEVEL
CONTROL
65067406:
SCOTSMAN ICE
SRL



L=223mm

1129015 SENSORE
CONTR. LIVELLO
GHIACCIO CUBETTI /
ICE LEVEL BORE
65067407:
SCOTSMAN ICE
SRL
65067400:
SCOTSMAN ICE
SRL



L=310mm

1129240 ICE LEVEL
SENSOR /
ICE LEVEL SENSOR
1100054021:
SCOTSMAN ICE
SRL
0200340921:
SCOTSMAN ICE
SRL



1129196 ICE LEVEL
CONTROL /
ICE LEVEL
CONTROL
CM25702402:
SCOTSMAN ICE
SRL
CM25702402/0:
CASTEL MAC SPA



1129220 THERMO
PROBE SERVICE /
THERMO PROBE
SERVICE
0A03310122:
SCOTSMAN ICE
SRL



1129224 ASSIEME

SONDA 230V /
HOT GAS VALVE
BODY ONLY

IOM2061962025:

SCOTSMAN ICE
SRL

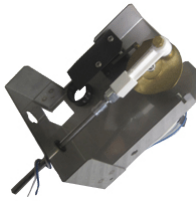

1129249 POWER

ADAPTOR /
POWER ADAPTOR

63015100:

SCOTSMAN ICE
SRL



1129258 SENSORE

DI ROTAZIONE
GM1100 /
ROTATION SENSOR
GM1100

R231028:

BREMA ICE MAKERS

NR231028: N.T.F.

SRL

EUR231028:

BRICE ITALIA SRL



1129215 SONDA

EWHS 280 UMIDITA'
SN560000 /
PROBE EWHS 280



1129234 SONDA

CUORE SPIL.AD L /
CORE
TEMPERATURE
PROBE NTC

32V8360:

ANGELO PO

GRANDI CUCINE

SPA



1129270 SONDA AL

CUORE 3 TEGLIE /
CORE PROBE FOR 3
PANS

RIC.S506/4:

A.T.O. SRL

RIC.S506/4: MBM-



1129158 SONDA

SPILLONE 90Ø
ARTICOLO:
ECSNDX0008 /
BORE 90? ITEM:
ECSNDX0008

CM33580149/0:

CASTEL MAC SPA



1129278 SONDA

PTC IP67 3.5 M A
SPILLONE 90° /
PROBE 90° PTC

E043673510:

COLD LINE S.R.L.



1129178 "SONDA

SPILLONE; W/CABLE
L.4075" /
PROBE W/CABLE
L.4075

088044:

ELECTROLUX
PROFESSIONAL
S.P.A.



1129261 SONDA

SPILLONE ABF
(CUORE) PTC 3M /
CORE PROBE ABF
(HEART) PTC 3M

35826:

EVERLASTING SRL



1129039 SONDA AL

CUORE X
ABBATTITTORE DX /
BLAST CHILLER
RIGHT BORE

RA930010:

HIBER - ALI S.p.A.

SIRRA930010:

LAINOX ALI SPA

SIRRA930010:

SILKO ALI SPA

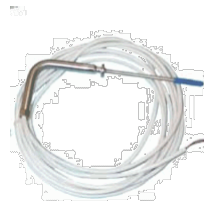

1129184 SONDA AL

CUORE /
PROBE

FR965295:

HIBER - ALI S.p.A.

FR965295:

LAINOX ALI SPA

FR965295:

OLIS DIVISIONE
DI ALI GROUP SPA -

FR965295:

SILKO ALI SPA



1129269 SONDA AL

CUORE /
CORE PROBE

3805061:

IRINOX SPA

3805060:

IRINOX SPA



1129174 SONDA

INF. C/RISC. PTC
3MT. SIL /
PROBE 3MT SIL

SIRRA930002:

MARENO

DX112T:



MARENO
INDUSTRIE ALI
SPA
SIRRA930002:
LAINOX ALI SPA
SIRRA930002:
SILKO ALI SPA

1129190 SONDA AL
CUORE FC6 PT100
L110 /
PROBE FC6 PT100
L110
2912400:
MARENO
INDUSTRIE ALI
SPA
R65320190:
LAINOX ALI SPA
LAR65320190:
MARENO
LAR65320190:
LAINOX ALI SPA



1129262 SONDA
SPILLONE PT1000 1
LIV 90° 5000 RISCA /
CORE PROBE PT1000
1 LIV 90th 5000 Risca
FR996452:
OLIS DIVISIONE
DI ALI GROUP SPA -
FR996452:
LAINOX ALI SPA
FR996452:
SILKO ALI SPA



1129233 SONDA AL
CUORE
ABBATTITTORE /
CORE
TEMPERATURE
PROBE
SIRRA930013:
SILKO ALI SPA
SIRRA930013:
LAINOX ALI SPA
SIRRA930013:
HIBER - ALI S.p.A.



1129281 SONDA AL
CUORE TPE PT1000
CL.B D.4MM
L=100mm E=1500mm
TRA
P3B40100A1500AGX
ABBATTITTORE /
CORE PROBE PT1000
cl.B D.4MM TPE L =
100mm E = 1500mm
TRA
P3B40100A1500AGX
BLAST CHILLER



2 FILI

1129282 SONDA AL
CUORE PT100
IMPUGNATURA TPE
AD AGO INOX
D.4MM L100mm
E1500mm TRA P1B4
0100A1500AHX
ABBATTITTORE /
CORE PROBE
HANDLE TPE
NEEDLE STEEL
DA.4MM L100mm
E1500mm TRA P1B4
0100A1500AHX
BLAST CHILLER



4 FILI

1129296 "SONDA;
L=2METER" /
PROBE L=2 METER
092360:
ELECTROLUX
PROFESSIONAL
S.P.A.



1129152 SENSORE
LIVELLO IMF /
ICE LEVEL IMF
KIT23870:
BREMA ICE MAKERS
SPA
NKIT23870:
N.T.F. SRL
IMF:
BREMA ICE MAKERS
SPA



1129161 PTCR /
PTCR
1800883501:
SCOTSMAN ICE
SRL



1134053 MOTORID
UTTORE PALETTE
CMB /
SMALL MIXER ARM
MOTO REDUCER
CMB
819440059:
GRUPPO CIMBALI
CM19440059*:
SIMAG SPA
CM19440059/01:
CASTEL MAC SPA
601039:
ARISTARCO SPA
926061:
BRICE ITALIA SRL
RG000636:
EURFRIGOR SRL
19440059/0:
ICEMATIC
1LT078: MIGEL
CM19440059/1:
CASTEL MAC SPA

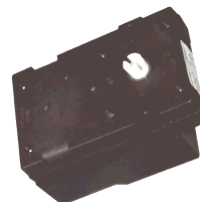

1134013 MOTOAGI
TATORE VEGA 30/30 /
MOTO-MIXER WEGA
30/30
1763006:
COSMETAL SRL



1134003 MOTORID
UTTORE
RIBALTAMENTO /
TILTING MOTO
REDUCER
926060:
BRICE ITALIA SRL
RG00A684:
EURFRIGOR
RG00A684:
EURFRIGOR SRL



1134007 MOTORID
UTTORE M330 0,7rpm
OR. /
"MOTO REDUCER
M330 1/G/85"" OR."
019440063/00:
ICEMATIC
CM019440063/00:
CASTEL MAC SPA
819440063:
GRUPPO CIMBALI



1134008 MOTORID
UTTORE M330 1/G85"
ANT. /
"ANTICLOCKWISE
MOTOREDCER
M330 1/G85"" "
CM19440065:
SIMAG
19440065/0:
ICEMATIC
CM19440065/0:
CASTEL MAC SPA
CM19440065:
SCOTSMAN ICE
SRL
819440065:
GRUPPO CIMBALI
SPA



1134019 MOTORID
UTTORE 1GITO/60"
220/50 /
"MOTO REDUCER
1GITO/60"" 220/50"
CM19440073:
SCOTSMAN ICE
SRL
CM19440073/0:
CASTEL MAC SPA



1134012 MOTORIB
ALTATORE VEGA
20/30 /
TILTING MOTO
REDUCER WEGA
20/30
17613007:
COSMETAL SRL



1134021 MOTORID
UTTORE M3301/G85
115/60 /
MOTO REDUCER
M3301/G85 115/60
CM19440069/0:
CASTEL MAC SPA
19440069/0:
ICEMATIC



1134033 MOTORID
UTTORE COMPLETO
STAFF 90 /
COMPLETE MOTO
REDUCER STAFF 90
9082020700:
STAFF ICE SYSTEM
8201200EX:
STAFF ICE SYSTEM



1134102 MOTORID
UTTORE EURFRIGOR
/
MOTO REDUCER
EURFRIGOR
RG00C565:EURFRIG
OR
EL130W:
BRICE ITALIA SRL

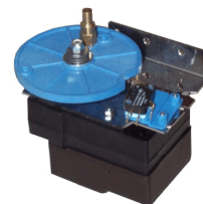

1134009 MOTORID.
RIB.
COMPL./STAFFA+CA
MM /
COMPLETE TILTING
MOTO
REDUCER+STIRRUP+
CAM
RG00B231:
EURFRIGOR SRL
AS928050: BRICE

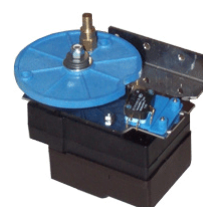

1134122 RG00B231-
ASSIEME
MOTORIDUTTORE
RIBALTAMENTO
EC60-80 /
RG00B231-
ASSEMBLY TILTING
GEARMOTOR EC60-
80
AS928052:
BRICE ITALIA SRL

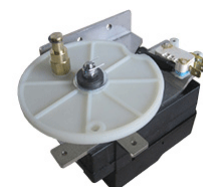

1134095 MOTORID
UTTORE
RIBALTAMENTO
COMPLETO /
TIPPING GEAR
MOTOR COMPLETE
RG00B595:
BRICE ITALIA SRL

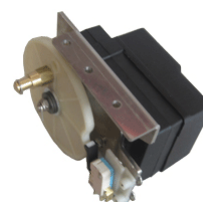

RG008595:
EURFRIGOR ICE
MAKERS SRL

1134037 ASS.MOTO
RIDUTTORE
RIBALT.N12S VDE /
TILTING MOTO
REDUCER KIT N12S
VDE
CM81442072/0:
CASTEL MAC SPA



1134096 ASS.
MOTORID.RIBALTA
M.N20N30 /
TILTING MOTO
REDUCER N20 N30
81404000/0:
ICEMATIC
CM81404000:
SCOTSMAN ICE
SRL
CM81404000/0:
CASTEL MAC SPA

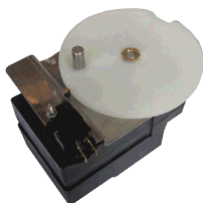

1134093 ASS.MOTO
RID.RIBALT.N20-30 /
TILTING MOTO
REDUCER N20-30
81404024/0:
ICEMATIC
CM81404024:
SCOTSMAN ICE
SRL
CM81404024/0:
CASTEL MAC SPA



1134011 ASSIEME
MOTORIDUTTORE
RIB. N55 /
TILTING MOTO
REDUCER N55
81413041/0:
ICEMATIC
CM81413041:
SCOTSMAN ICE
SRL
CM81413041/0:
CASTEL MAC SPA



1134123 5363
MOTO-RIDUTTORE
20-30 /
MOTOR VOLTEADOR
20-30
20-30: I.T.V. S.A.



1134105 5200
MOTORIDUTTORE
ITV /
MOTO REDUCER ITV
105200: I.T.V. S.A.

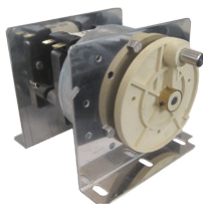

4114754 CAMME
SENZA INSERTI /
DISK
RH003620:
EURFRIGOR SRL
910012: BRICE



1134014 ASS.
DISCO MOTORID. N1-
2-3 /
MOTO REDUCER
DISK KIT N1-2-3
25260010/5:
ICEMATIC
CM25260010/5:
CASTEL MAC SPA

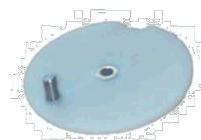

4114056 ASSIEME
DISCO
MOTORIDUTTORE
N5-7-12 /
GEARMOTOR DISC
SET N5-7-12-22
CM25260001:
SCOTSMAN ICE
SRL
CM25260001/1:
CASTEL MAC SPA

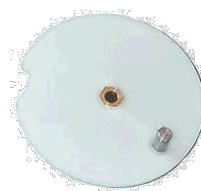

4114020 ASSIEME
DISCO
MOTORIDUTTORE
N20/30 /
GEARMOTOR DISC
SET RIB. N20/30
25260000/0:
ICEMATIC
CM25260000:
SCOTSMAN ICE
SRL



4114520 ASS.DISCO
MOTORIDUTTORE
N55 /
GEARMOTOR DISC
N55
CM814130430:
CASTEL MAC SPA
814130430/0:
ICEMATIC
CM81413043:
SCOTSMAN ICE
SRL

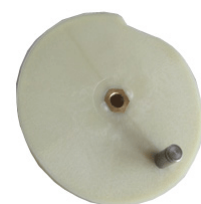

4122410 CAMME
KP30:90 /
CAMME KP30:90
1CD093: MIGEL
S.R.L.



1134106 MOTORID
UTTORE PALETTE /
SMALL MIXER ARM
MOTO REDUCER

23937:

**BREMA ICE MAKERS
SPA**



1134047 MOTORID

UTTORE
G03.55.0A.AB.EA
M52+W01 /
MOTO REDUCER
G03.55.0A.AB.EA
M52+W01

23341:

**BREMA ICE MAKERS
SPA**



1134057 MOTORID
UTTORE PALETTE
IMF /
SMALL MIXER ARM
MOTO REDUCER IMF

23802:

**BREMA ICE MAKERS
SPA**



1134094 MOTORID
UTTORE PALETTE /
SMALL MIXER ARM
MOTO REDUCER

23801:

**BREMA ICE
MAKERS SPA**



1134058 MOTORID
UTTORE
RIBALTAMENTO
BACINELLA IMF 28-
35-58 /
MOTO REDUCER IMF

C26742: **BREMA**



1134084 ASSIEME
MOTORIDUTTORE
CON SUPPORTO
IMF80 /
MOTOREDCER
IMF85

C26743: **BREMA**

NC26743: **N.T.F. SRL**



1134112 ASSIEME
MOTORIDUTTORE
CON SUPPORTO /
GEARMOTOR WITH
SUPPORT ASSY

C26746: **BREMA**

NC26746: **N.T.F. SRL**



1107232 MOTORID
UTTORE DI
RIBALTAMENTO
CON SUPPORTO X
IMF80 NEW /
TILTING
MOTOREDCER
WITH BRACKET FOR
IMF80

NC26748: **N.T.F. SRL**

IMF80 NEW:

**BREMA ICE MAKERS
SPA**



1134023 MOTORID
UTTORE PALETTE /
SMALL MIXER ARM
MOTO REDUCER

RG003650:

EURFRIGOR SRL

RG00B534:

BRICE ITALIA SRL

RG003650:

BRICE ITALIA SRL

RG00B534:

**EURFRIGOR ICE
MAKERS SRL**



1134026 MOTOAGI
TATORE ITV 20-30
KG. /
MOTO-MIXER ITV 20-
30 KG.

Q20-30-40: **I.T.V.**

S.A.

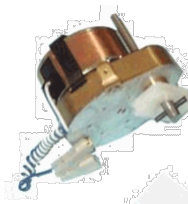

1134025 MOTOAGI
TATORE ITV >30 KG.
/
MOTO-MIXER ITV
>30 KG.

205201: **I.T.V. S.A.**

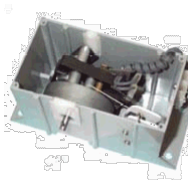

1134114 ASSIEME
MOTORIDUTTORE /
GEAR MOTOR

IOM206196207S:

**SCOTSMAN ICE
SRL**



1134029 MOTOAGI
TATORE 220V CON
CONDENSATORE
MASTER /
MOTOMIXER 220V
WITH CAPACITOR
MASTER

9082013500+90203:

STAFF ICE SYSTEM



1134078 MOTOAG.
220V G0355AMADBH
M52W0150RPM4FB2
/
MOTOREDUCER
220V G0355AMADBH
M52W0150RPM4FB2
9082013000: STAFF
9082013500: STAFF
3004010000: STAFF



1134031 MOTOAGI
TATORE X MP22
STAFF /
MOTOMIXER X MP22
STAFF
9082010500:
STAFF ICE SYSTEM
90820105:
STAFF ICE SYSTEM



4114133 SUPPORT
O MOTOAGITATORE
/
MOTOREDUCER
SUPPORT
9020372000:
STAFF ICE SYSTEM



1134101 MOTORIN
O AGITATORE 230V
50/60HZ /
MOTO-MIXER 230V
50/60HZ
3380006700:
UGOLINI SPA



ALBERO Ø 10X19mm

1134115 MOTORID
UTTORE COMPLETO
24V 50Hz PER
GRANITORI /
GEAR MOTOR 24V
50HZ



1134077 RIDUTTOR
E STAFF /
MOTO REDUCER
STAFF
300590000:
STAFF ICE SYSTEM
SRL



1134076 MOTORID
UTTORE /
MOTO REDUCER
23310:
BREMA ICE MAKERS
SPA

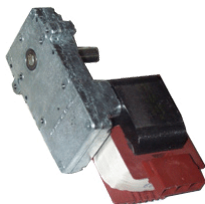

1134120 MOTOR&
GEARS 50HZ /
MOTOR&GEARS
50HZ
1200161006:
SCOTSMAN ICE
SRL



1134118 MOTORID
UTTORE + CELLA DI
HALL FC M40181229 /
MOTO-REDUCER +
REFRIGERATOR
HALL FC M40181229



1134049 MOTORID
UTTORE BREMA /
MOTO REDUCER
BREMA
R231030: BREMA
23532EX: BREMA
926167: BRICE



1134075 MOTORID.
230V-50/60HZ 23571
SENZA
DISGIUNTORE /
MOTO REDUCER
230V-50/60HZ 23571
23638: BREMA
N23638: N.T.F. SRL



1134035 MOTORID
UTTORE BREMA G
250-500-1000 (1°) /
MOTO REDUCER
BREMA G 250-500-
1000 (1°)
23571:
BREMA ICE MAKERS



1134027 ASSIEME
MOTORIDUTTORE /
MOTO REDUCER KIT
I79422513R: GIGA
79422513R:
SCOTSMAN ICE
SRL
*: CASTEL MAC SPA



1134017 ASSIEME
MOTORIDUTTORE
MF41/51/61 /
MOTO REDUCER KIT
MF41/51
79421508R:
SCOTSMAN ICE
SRL
*: CASTEL MAC SPA



1134136 MOTORID
UTTORE ASSIEMATO
1/10HP /
ASSY GEARMOTOR
1/10HP
0200439921:
SCOTSMAN ICE
SRL



1134092 GEAR
REDUCER&MOTOR
(CE) /
GEAR
REDUCER&MOTOR
(CE)
0A03322022:
SCOTSMAN ICE
SRL



1134066 ASSIEME
MOTORIDUTTORE /
GEAR MOTOR
C23412: BREMA



1134135 ASSIEME
MOTORIDUTTORE
(MR VF 44/F R1:230) /
GEARMOTOR
ASSEMBLY (MR VF
44 / R1: 230)
C23389: BREMA ICE



1134103 RIDUTTOR
E A VITE ES 50/70/100
* /
GEAR MOTOR
ES50/70/100
RGO0B141:
EURFRIGOR SRL
RGO0B141: BRICE
926073: BRICE

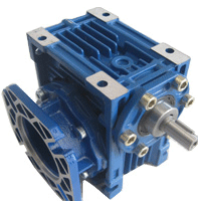

1134108 RIDUTTOR
E VF 49F R.1/60
OPP.CATAL. ES200 /
GEAR MOTOR VF
49F R.1/60
OPP.CATAL. ES200
RGO0B649:
EURFRIGOR SRL
ES200: BRICE



1134089 RIDUTTOR
E VF44F 1:35 /
GEAR REDUCER
VF44F 1:35
1TR002: MIGEL
S.R.L.



1134132 RIDUTTOR
E VF49 /
GEAR VF 49
1TR003: MIGEL
S.R.L.



1134087 GEAR
REDUCER VF/W30/63
/
GEAR REDUCER
VF/W30/63
62037702:
SCOTSMAN ICE
SRL
62037704:
SCOTSMAN ICE
SRL
06068200:
SCOTSMAN ICE
SRL



1134065 MOTOR
KIT /
MOTOR KIT
6027306:
SCOTSMAN ICE
SRL



1134042 CALOTTA
ABS+ VITI /
COVER ABS

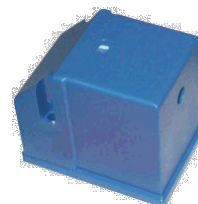

1134006 MOTORID
UTTORE FR 10-40-
33/207 /
MOTO REDUCER FR
10-40-33/207



1134111 MOTORID
UTTORE ITV /
GEAR MOTOR ITV
4154: I.T.V. S.A.



1134113 MOTORID
UTTORE IMBALLATO
6L 230V 50HZ /
GEARMOTOR 6L
230V 50HZ
3370000010:
UGOLINI SPA



Øa 12X6mm H=16mm,
Øb 12 H=52mm, H

totale albero= 68mm,
ALBERO:

1134126 MOTORID
UTTORE 230V 50HZ
SIST MAGNETICO /
GEAR MOTOR 230V
50HZ MAGNETIC
SYSTEM
3380004770:
UGOLINI SPA









Øa 8 H=13mm, Øb
12X8mm H=24mm, H
totale albero= 37mm,
ALBERO:

1134071 MOTORID
UTTORE 230 50HZ
SIST. NON
MAGNETICO /
MOTO-REDUCER 230
50HZ NT MAGNETIC
SYSTEM
3380004790:
UGOLINI SPA



1134127
MOTORIDUTTORE 24
V /
MOTO GEAR 24 V
3Q0000080:
UGOLINI SPA



CODICE S&P S&P CODE		CAPACITA' ELETTRICA μ F CAPACITANCE μ F	ADATTABILITA' ADAPTABILITY
1135008		4 μ F	
1135007		5 μ F	206010: ELETTOBAR DIVISIONE DELLA EUROTEC SRL 631208: COMENDA ALI SPA 00300105: LAMBER DI AFFABA FRANCESCO & C. 3113034: WINTERHALTER ITALIA SRL
1135003		6,3 μ F	631216: COMENDA ALI SPA 0300110: LAMBER DI AFFABA FRANCESCO & C.
1135004		8 μ F	631201: COMENDA ALI SPA 32Z2490: ANGELO PO
1135001		10 μ F	180018: MAGISTER SISTEMA CAFFE' SRL 34020003: RANCILIO SPA 0300106: LAMBER DI AFFABA FRANCESCO & C. R65190180: LAINOX ALI SPA 531401600: CIMBALI
1135002		12,5 μ F	34020004: RANCILIO SPA CECN12: I.M.E. SRL 621207: COMENDA ALI SPA DW1581: DIHR-ALI SPA 047883: ZANUSSI 047541: ZANUSSI
1135006		16 μ F	3400016: RANCILIO SPA 206004: ELETTOBAR DIVISIONE DELLA EUROTEC SRL
1135005		18 μ F	
1135012		20 μ F	206005: ELETTOBAR DIVISIONE DELLA EUROTEC SRL
1135010		25 μ F	

1135042 CONDENZA
TORE 30 MF U.L. /
CAPACITOR 30 MF
U.L.

5000COE08QQQ:
MAZZER LUIGI SRL



1135011 CONDENZA
TORE 100/125 MF /
CAPACITOR 100/125
MF



1135014 CONDENZA
TORE 0,12MF 1000V /
CONDENSER 0,12MF
1000V

23318:
**BREMA ICE MAKERS
SPA**

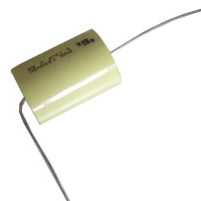

1135026 START
CAPACITOR /
START CAPACITOR

62016729:
**SCOTSMAN DIV.
FRIMONT SPA**
CF62016729:
CASTEL MAC SPA



1135045 START
CAPACITOR /
START CAPACITOR

62016717:
SCOTSMAN ICE SRL



1135015 RUN
CAPACITOR
SCOTSMAN /
RUN CAPACITOR
SCOTSMAN

620116725:
**SCOTSMAN DIV.
FRIMONT SPA**



1135045 START
CAPACITOR /
START CAPACITOR

62016717:
**SCOTSMAN DIV.
FRIMONT SPA**



1135049 CONDENZA
TORE DI SPUNTO /
RUN CAPACITOR

1800370101:
SCOTSMAN ICE SRL



1135028 ASSIEME
CONDENSATORE 21 22
25 W /
CONDENSER
ASSEMBLY 21 22 25 W

K00278:
ARISTARCO SPA



1135013 CONDENZA
TORE AD ACQUA /
WATER CAPACITOR

14014:
**BREMA ICE MAKERS
SPA**



4114182 CONDENZA
TORE AD ACQUA 2
SPIRE /
WATER CAPACITOR

14348:
**BREMA ICE MAKERS
SPA**



4114165 CONDENZA
TORE AD ACQUA 5
SPIRE D.210 /
WATER CAPACITOR 5
COILS D.210

14374:
**BREMA ICE MAKERS
SPA**



4114173 CONDENZA
TORE AD ACQUA /
WATER CAPACITOR

14034:
**BREMA ICE MAKERS
SPA**



4114132 CONDENZA
TORE AD ACQUA 3
SPIRE /
WATER CAPACITOR 3
COILS

087961:
**ELECTROLUX
PROFESSIONAL
S.P.A.**
14002ex:
**BREMA ICE MAKERS
SPA**



4114552 CONDENSATORE AD ACQUA / WATER CONDENSER

14507:

BREMA ICE MAKERS SPA



1135034 RC00A364-CONDENSATORE EC 30/40/ES70 / CONDENSER FOR EC30/40/ES70

914006:

BRICE ITALIA SRL



4114341 ASSIEME CONDENSATORE N30W / CONDENSER N30W

814015930:

CASTEL MAC SPA



1135035 ASS. COND. N70W R134A / ASSEMBLY CONDENSER R134A N70W

81408155/0:

CASTEL MAC SPA

CM81408155:

SCOTSMAN DIV.

FRIMONT SPA



4114928 CONDENSATORE AD ACQUA / WATER CONDENSER

14081:

BREMA ICE MAKERS SPA



7 Spire

1135031 ASS. CONDENSATORE 28 30 W / CONDENSER 2830W

K00112: **KASTEL SRL**



4122445 CONDENSATORE W KL71/131 - KF250 / WATER CONDENSER KL71/131 -KF250

2CD044:

MIGEL S.R.L.



H=230mm, Ø=150mm,
12 spire

1135051 EVAPORATORE 5L MONOCOLONNA / EVAPORATOR 5L SINGLE COLUMN

3165200:

ANGELO PO GRANDI CUCINE SPA



1135022 CONDENSATORE AD ARIA / AIR CONDENSER

20534:

BREMA ICE MAKERS SPA

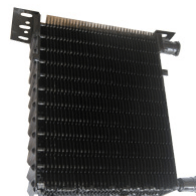

1135041 Condensatore ad aria / Air cooled condenser

20854:

BREMA ICE MAKERS SPA



4114644 CONDENSATORE AD ARIA / AIR CAPACITOR

20283:

BREMA ICE MAKERS SPA



4114958 CONDENSATORE AD ARIA / AIR CONDENSER

20030:

BREMA ICE MAKERS SPA



4114329 CONDENSATORE AD ARIA / AIR CONDENSER

20264:

BREMA ICE MAKERS SPA

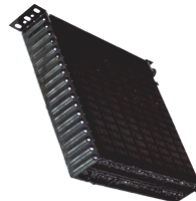

P= 60 mm, H= 275 mm,
L=335 mm

4114714 CONDENSATORE AD ARIA / AIR CONDENSER

*: **BREMA ICE MAKERS SPA**

N20558: **N.T.F. SRL**

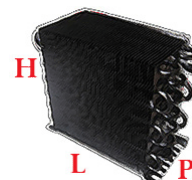
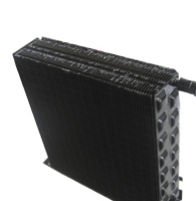

P= 60 mm, H= 245 mm,
L= 260 mm

4114336 CONDENSA
TORE AD ARIA /
AIR CONDENSER
20148ex:
BREMA ICE MAKERS
SPA

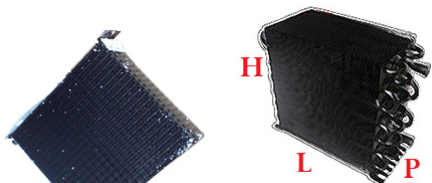

P= 143 mm, H= 395 mm,
L=320 mm

4114200 CONDENSA
TORE ARIA BRM /
AIR CAPACITOR BRM
20019:
BREMA ICE MAKERS
SPA



P= 120 mm, H= 210 mm,
L=260 mm

4114167 CONDENSA
TORE AD ARIA /
AIR CONDENSER
20094:
BREMA ICE MAKERS
SPA



1135047 AIR
COOLED CONDENSER
/
AIR COOLED
CONDENSER
CMCF62043900:
CASTEL MAC SPA
62043900:
SCOTSMAN ICE SRL

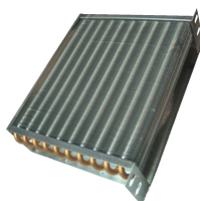

4114397 CONDENSA
TORE F200 ARIA / AIR
CAPACITOR F200
CF62040500:
CASTEL MAC SPA
62040500:
SCOTSMAN DIV.
FRIMONT SPA

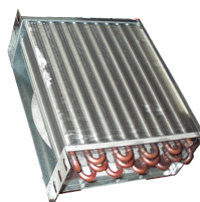

1135052 2593 AIR
CONDENSER /
2593 AIR CONDENSER
2593: I.T.V. S.A.

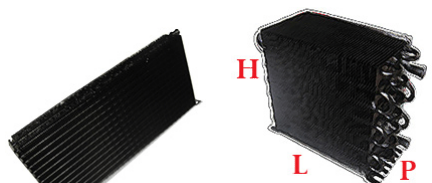

P= 60 mm, H= 215 mm,
L= 515 mm

1135057 2423
CONDENSER /
CONDENSER
302423:
I.T.V. S.A.

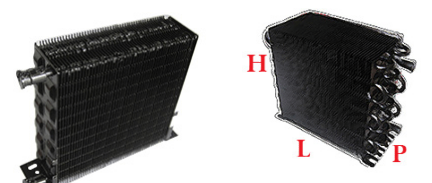

P= 60 mm, H= 180 mm,

L= 200 mm

4122273 CONDENSA
TORE STFT 14121 /
CONDENSATOR STFT
14121
1RF002: MIGEL S.R.L.



DIMENSIONS
230X210MM

4122065 CONDENSA
TORE STFT 14221 /
CONDENSER STFT
14221
1RF040: MIGEL S.R.L.

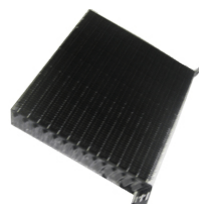

4114879 AIR
COOLED CONDENSER
/
AIR COOLED
CONDENSER
62042000:
SCOTSMAN DIV.
FRIMONT SPA
NM62042000:
CASTEL MAC SPA



P= 90 mm, H= 215 mm,
L= 260 mm

1135047 AIR
COOLED CONDENSER
/
AIR COOLED
CONDENSER
CF62043900:
CASTEL MAC SPA
62043900:
SCOTSMAN DIV.
FRIMONT SPA

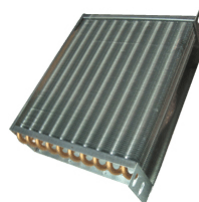

1135024 CONDENSA
TORE ARIA D74476 /
AIR CONDENSER
D74476
N20406: N.T.F. SRL
20406:
BREMA ICE MAKERS

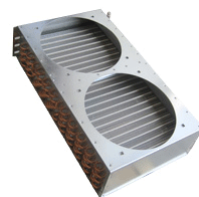

1135056 CONDENSA
TORE AD ARIA D75515
30 BAR - UL /
AIR CONDENSER
D75515 30 BAR - UL
N20787:
N.T.F. SRL
EU20787:
BRICE ITALIA SRL
20787:
BREMA ICE MAKERS
SPA



P= 130mm, H= 490mm,
L= 690mm

4114961 AIRCOOLE
DCONDENSER /
AIR COOLED
CONDENSER
62043400:
SCOTSMAN DIV.
FRIMONT SPA

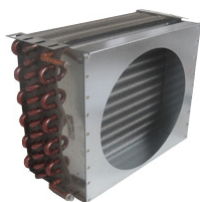

4114449 AIR
COOLED CONDENSER
/
AIR COOLED
CONDENSER
62043700:
SCOTSMAN DIV.
FRIMONT SPA

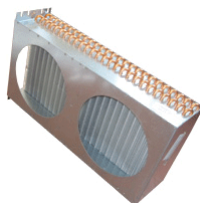

4114401 CONDENSA
TORE AD ACQUA /
WATER CAPACITOR
14285: BREMA ICE
MAKERS SPA



4114725 ASS.CONDE
NSATORE N20LW /
CONDENSOR N20LW
81407536/0:
CASTEL MAC SPA



4122241 WATER
COOLED CONDENSER
/
WATER COOLED
CONDENSER
XG62038901:
CASTEL MAC SPA
62038901:
SCOTSMAN DIV.
FRIMONT SPA





4114450 CONDENSE
R, WATER /
CONDENSER, WATER
62049501:
SCOTSMAN DIV.
FRIMONT SPA



4114487 WATER
COOLED CONDENSER
/ WATER COOLED
CONDENSER
62038900:
SCOTSMAN DIV.
FRIMONT SPA



	CODICE S&P S&P CODE	DESCRIZIONE DESCRIPTION	GAS
	4127146	VALVOLA TERMOSTATICA SERIE TN2 THERMOSTATIC VALVE TYPE TN2	R134
	4127148	VALVOLA TERMOSTATICA SERIE TS/2 THERMOSTATIC VALVE TYPE TS/2	R404
	4127141	VALVOLA TERMOSTATICA SERIE TEN/2 CON EQUALIZZATORE THERMOSTATIC VALVE TYPE TEN/2	R134
	4127149	VALVOLA TERMOSTATICA SERIE TES/2 CON EQUILAZZATORE THERMOSTATIC VALVE TYPE TES/2	R404

ORIFICI

CODICE S&P S&P CODE		TIPO TYPE
4105091		0X
4105092		00
4105088		01
4105093		02
4105094		03

**ADATTABILITA' VALVOLE TERMOSTATICHE-ORIFICI
ADAPTABILITY THERMOSTATIC VALVES-ORIFICI**

TIPO VALVOLA VALVE TYPE	ORIFICIO	GAS	CAPACITA'/ CAPACITY 0	CAPACITA'/ CAPACITY -10	CAPACITA'/ CAPACITY -30
TEX 2-0.15	0X	R22	0.59	0.57	0.49
TEX 2-0.3	00	R22	1.3	1.2	0.96
TEX 2-0.7	01	R22	3.0	2.5	1.7
TEX2-1.0	02	R22	4.3	3.6	2.7
TEX2-1.5	03	R22	7.8	6.4	4.2
TEX 2-2.3	04	R22	11.5	9.5	6.2
TEX 2-3.0	05	R22	14.6	12.0	7.8
TEX 2-4.5	06	R22	17.8	14.7	9.6
TEX 5-3	01	R22	20.8	17.7	11.1
TEX 5-4.5	02	R22	28.3	24.3	15.4
TEX5-.7.5	03	R22	40.6	35.6	22.7
TEX 5-12	04	R22	58.0	51.0	32.5
TEX12-4.5	01	R22	26.8	23.4	16.0
TEX12-7.5	02	R22	43.5	37.9	26.2
TEX12-12	03	R22	63.9	55.6	38.1
TEX12-18	04	R22	85.0	74.0	51.0
TEX20-30	01	R22	107	93.6	64.5
TEX55-50	01	R22	237	205	139
TEX55-85	02	R22	355	309	212

TIPO VALVOLA VALVE TYPE	ORIFICIO	GAS	CAPACITA'/ CAPACITY 0	CAPACITA'/ CAPACITY -10	CAPACITA'/ CAPACITY -30
TES 2-0.11	0X	R404A	0.40	0.39	0.34
TES 2-0.21	00	R404A	0.81	0.76	0.63
TES 2-0.45	01	R404A	1.68	1.44	0.96
TES 2-0.6	02	R404A	2.42	2.03	1.3
TES 2-1.2	03	R404A	4.34	3.64	2.34
TES 2-1.7	04	R404	6.4	5.35	3.43
TES 2-2.2	05	R404A	8.11	6.79	4.36
TES 2-2.6	06	R404A	9.9	8.3	5.34
TES 5-3.7	01	R404A	14.5	12.0	7.3
TES 5-5.0	02	R404A	19.6	16.6	10.3
TES 5-7.2	03	R404A	28.8	24.5	15.4
TES 5-10.3	04	R404A	41.4	35.0	22.1
TES 12-4.2	01	R404A	16.31	14.1	9.3
TES 12-6.8	02	R404A	26.4	23.0	15.3
TES 12-10.0	03	R404A	37.7	33.6	22.4
TES 12-13.4	04	R404A	51.7	45.1	30.3
TES 20-16.7	01	R404A	64.0	56.0	37.0
TES 55-37.0	01	R404A	142	122	80
TES 55-56.0	02	R404A	214	186	123

TIPO VALVOLA VALVE TYPE	ORIFICIO	GAS	CAPACITA'/ CAPACITY 0	CAPACITA'/ CAPACITY -10	CAPACITA'/ CAPACITY -30
TEN 2-0.11	0X	R134A	0.47	0.44	0.37
TEN 2-0.25	00	R134A	0.89	0.81	0.64
TEN 2-0.5	01	R134A	1.8	1.46	0.93
TEN 2-0.8	02	R134A	2.58	2.06	1.27
TEN 2-1.3	03	R134A	4.61	3.69	2.28
TEN 2-1.9	04	R134A	6.8	5.42	3.33
TEN 2-2.5	05	R134A	8.62	6.88	4.24
TEN 2-3.0	06	R134A	10.5	8.40	5.18
TEN 5-3.7	01	R134A	13.0	10.3	5.97
TEN 5-5.4	02	R134A	19.4	15.5	9.15
TEN 5-8.3	03	R134A	28.5	22.8	13.6
TEN 5-11.2	04	R134A	40.8	32.7	19.5
TEN 12-4.7	01	R134A	17.3	14.3	8.96
TEN 12-7.7	02	R134A	28.1	23.3	14.7
TEN 12-11.4	03	R134A	41.1	34.0	21.5
TEN 12-15	04	R134A	54.9	45.5	28.9
TEN 20-18	01	R134A	67.8	56.2	35.8
TEN 55-41	01	R134A	150.1	123.1	76.4
TEN 55-62	02	R134A	227.4	188.1	118.4

TIPO VALVOLA VALVE TYPE	ORIFICIO	GAS	CAPACITA'/ CAPACITY 0	CAPACITA'/ CAPACITY -10	CAPACITA'/ CAPACITY -30
TEZ 2-0.11	0X	R407C	0.6	0.57	0.49
TEZ 2-0.21	00	R407C	1.3	1.2	1.0
TEZ 2-0.45	01	R407C	3.0	2.5	1.7
TEZ 2-0.6	02	R407C	4.3	3.6	2.7
TEZ 2-1.2	03	R407C	7.9	6.4	4.2
TEZ 2-1.7	04	R407C	11.6	9.5	6.1
TEZ 2-2.2	05	R407C	14.7	12.0	7.7
TEZ 2-2.6	06	R407C	18.0	14.7	9.5
TEZ 5-3.2	01	R407C	21.0	17.7	11.0
TEZ 5-5.0	02	R407C	28.6	24.3	15.2
TEZ 5-8.0	03	R407C	41.0	35.6	22.5
TEZ 5-13	04	R407C	58.6	51.0	32.2
TEZ 12-5.0	01	R407C	27.1	23.4	15.8
TEZ 12-8.0	02	R407C	43.9	37.9	25.9
TEZ 12-13	03	R407C	64.5	55.6	37.7
TEZ 12-19.5	04	R407C	86.0	74.0	50.5
TEZ 20-32.5	01	R407C	108	94	63.9
TEZ 55-54	01	R407C	239	205	138
TEZ 55-92	02	R407C	359	309	210







Compressori / Compressors

R404A: Media – alta pressione / Medium – high pressure (-25°C / + 10°C)

Codice/ Code S&P	Modello/ Model CUBIGEL	Cilindrata/ Capacity Cm ³	Potenza/ Power HP	Equivalente = Equivalent	EMBRACO - ASPERA	Tecumseh - U.H	DANFOSS
1137007	ML 45 TB	4,50	1/5		NB 6144 GK - NB 6152GK	AEZ 4425 Z	TL 4 DL
1137028	ML 60 TB	5,68	1/4		NE 6165 GK	AEZ 4430 Z	FR 6 DL
1137024	ML 80 TB	7,57	1/3		NE 6181 GK	AEZ 4440 Z	
1137018	ML 90 TB	8,86	1/3P		NE 6210 GK	CAE 4450 Z	SC 10 DL
1137043	MP 12RB	12,05	1/2		NE 9213 GK	CAE 9460 Z - CAE 9470 Z	SC 12 DL
1137044	MP 14RB	14,17	1/2P		T 6217 GK	CAE 9470 Z - CAJ 9480 Z	SC 15 DL









Compressori / Compressors

R404A: Media – alta pressione / Medium – high pressure (- 25°C / + 10°C)

Codice/ Code S&P	EMBRACO - ASPERA	Cilindrata / Capacity Cm ³	Potenza /Power HP	Equivalente = Equivalent	CUBIGEL	Tecumseh - U.H	DANFOSS
1137072	NB 6144 GK	4,50	1/5		ML 45 TB	AEZ 4425 Z	TL 4 DL
1137073	NE 6165 GK - NEK6165GK	5,68	1/4		ML 60 TB	AEZ 4430 Z	FR 6 DL
1137074	NE 6181 GK - NEK6181GK	7,57	1/3		ML 80 TB	AEZ 4440 Z	
1137075	NE 6210 GK - NEK6210GK	8,86	1/3P		ML 90 TB	CAE 4450 Z	SC 10 DL
1137076	NE 6213 GK - NEK6213GK	12,05	1/2		MP 12RB	CAE 9460 Z - CAE 9470 Z	SC 12 DL
1137077	T 6217 GK - NEK6217GK	14,17	1/2P		MP 14RB	CAE 9470 Z - CAJ 9480 Z	SC 15 DL

Compressori / Compressors

R134a: Media – alta pressione / Medium – high pressure (- 25°C / + 10°C)







Codice/ Code	Modello/ Model	Cilindrata/ Capacity	Potenza/ Power	Equivalente = Equivalent	EMBRACO - ASPERA	Tecumseh - U.H.	DANFOSS
S&P	CUBIGEL	Cm ³	HP				
1137045	GD 36 MB-D	3,62	1/9		BP 5125 H	AZ(THB) 3412 Y AZ(THB) 4412 Y	TL 4 G
1137046	GD40MB-D	4,06	1/8		BP 5128H	AZ(THB)3414 Y AZ(THB)4414 Y	TL 4 G
1137014	GL 45 PB GL 45 TB	4,50	1/6		NB 5132 Z		TL 5 G
1137047	GL 60 PB GL 60 TB	5,68	1/5		NB 5144 Z NB 6144Z	AZ 3419 Y AZ 4419 Y	FR 6 G
1137015	GL 80 TB	7,57	1/4		NB 6160 Z	AEZ 4425 Y	FR 7GH - FR 7,5GH
1137016	GL 90 TB	8,85	1/4P		NE 6170 Z	AEZ 4430 Y	FR 8,5GH - FR 10 GH
1137026	GP 12 TB	12,05	1/3		NE 6187 Z	CAE 4440Y	SC 12 GH
1137048	GP 14 TB	14,17	1/3P		NE 6210 Z	CAE 4448 Y	SC 15 G

Compressori / Compressors
R134a: Media – alta pressione / Medium – high pressure (- 25°C / + 10°C)

Codice/ Code S&P	EMBRACO - ASPERA	Cilindrata / Capacity Cm ³	Potenza/ Power HP	Equivalente = Equivalent	CUBIGEL	Tecumseh - U.H.	DANFOSS
1137084	BP 5128H EMT45HDR	4,06	1/8		GD40MB-D	AZ(THB)3414 Y AZ(THB)4414 Y	TL 4 G
1137085	NB 5132 Z EMT50HDP	4,50	1/6		GL 45 PB GL 45 TB		TL 5 G
1137086	NB 5144 Z NB6144 Z EMT6144Z	5,68	1/5		GL 60 PB GL 60 TB	AZ 3419 Y AZ 4419 Y	FR 6 G
1137087	NB 6160 Z EMT6160Z	7,57	1/4		GL 80 TB	AEZ 4425 Y	FR 7GH - FR 7,5GH
1137088	NE 6170 Z EMT6170Z	8,85	1/4P		GL 90 TB	AEZ 4430 Y	FR 8,5GH - FR 10 GH
1137089	NE 6187 Z NEK6187Z	12,05	1/3		GP 12 TB	CAE 4440Y	SC 12 GH
1137090	NE 6210 Z NEK6210Z	14,17	1/3P		GP 14 TB	CAE 4448 Y	SC 15 G

Unità condensatrici valvola/ Condensing units

R404A: Media – alta pressione / Medium – high pressure (- 25°C / + 10°C)







Codice/Code S&P		Modello/Model CUBIGEL	Cilindrata/Capacity Cm³	Potenza/Power HP
1137049		ML 45 TB	4,50	1/5
1137050		ML 60 TB	5,68	1/4
1137051		ML 80 TB	7,57	1/3
1137052		ML 90 TB	8,86	1/3P
1137053		MP 12 RB	12,05	1/2
1137054		MP 14 RB	14,17	1/2P

Unità condensatrici valvola/ Condensing units
R404A: Media – alta pressione / Medium – high pressure (- 25°C / + 10°C)

Codice/Code S&P		EMBRACO - ASPERA	Cilindrata/Capacity Cm ³	Potenza/Power HP
1137078		NB 6144 GK	4,50	1/5
1137079		NE 6165 GK - NEK6165GK	5,68	1/4
1137080		NE 6181 GK - NEK6181GK	7,57	1/3
1137081		NE 6210 GK - NEK6210GK	8,86	1/3P
1137082		NE 6213 GK - NEK6213GK	12,05	1/2
1137083		T 6217 GK - NEK6217GK	14,17	1/2P

Unità condensatrici valvola/ Condensing units

R134A: Media – alta pressione / Medium – high pressure (- 25°C / + 10°C)

Codice/Code S&P		Modello/Model CUBIGEL	Cilindrata/Capacity Cm³	Potenza/Power HP
1137055		GL 60 TB	5,68	1/5
1137056		GL 80 TB	7,57	1/4
1137057		GL 90 TB	8,85	1/4P
1137042		GP 12 TB	12,05	1/3
1137058		GP 14 TB	14,17	1/3P
1137059		GX18 TB	18,40	1/2P

Unità condensatrici valvola/ Condensing units
R134A: Media – alta pressione / Medium – high pressure (- 25°C / + 10°C)

Codice/Code S&P		EMBRACO - ASPERA	Cilindrata/Capacity Cm ³	Potenza/Power HP
1137091		NB 5144 Z NB6144 Z EMT6144Z	5,68	1/5
1137092		NB 6160 Z EMT6160Z	7,57	1/4
1137093		NE 6170 Z EMT6170Z	8,85	1/4P
1137094		NE 6187 Z NEK6187Z	12,05	1/3
1137095		NE 6210 Z NEK6210Z	14,17	1/3P
1137096		NEK6212Z	18,40	1/2P

1137061 COMPRESS
ORE R22 /
COMPRESSOR R22



1137062 COMPRESS
ORE R22 L40TN /
COMPRESSOR R22
L40TN



1137128 Compressore
FH4531Z /
COMPRESSOR FH4531Z
N23489*: N.T.F. SRL
23489*:
BREMA ICE MAKERS
SPA



1137002 COMPRESS
ORE FH4531Z R 404A
220/60 BREMA /
COMPRESSOR FH4531Z
220/60 BREMA
23527:
BREMA ICE MAKERS
SPA



1137041 COMPRESS
ORE FH4540Z 230V
R404A /
COMPRESSOR FH4540Z
230V
23647*:
BREMA ICE MAKERS
SPA



1137154 COMPRESS
ORE EMT 2125GK R404
/
COMPRESSOR EMT
2125GK R404



1137108 COMPRESS
ORE EMT6144GK 220/50
R404A /
COMPRESSOR
EMT6144GK 220/50
R404A
23886:
BREMA ICE MAKERS
SPA
1RF181: MIGEL S.R.L.
1RF124: MIGEL S.R.L.



1137155 COMPRESS
ORE NE9213GK (R404)
220/60 /
COMPRESSOR
NE9213GK CSR BOX
N23504A:
BREMA ICE MAKERS
SPA
N23504A: N.T.F. SRL



1137007 COMPRESS
ORE 1/5HP
MEDIA/ALTA
PRESSIONE R404A /
COMPRESSOR 1/5HP
PRESSURE R404A
23436:
BREMA ICE MAKERS
SPA
67010017:
SCOTSMAN ICE SRL
CMCF67010017:



CASTEL MAC SPA

1137028 COMPRESS
ORE 1/4HP MEDIA-
ALTA PRESSIONE
R404A /
COMPRESSOR
23441:
BREMA ICE MAKERS
SPA
089170:
ELECTROLUX
PROFESSIONAL
S.P.A.



1137024 COMPRESS
ORE 1/3HP MEDIA-
ALTA PRESSIONE
R404A /
COMPRESSOR ML80TB
68023437:
RANCILIO SPA
N23437: N.T.F. SRL
23437:
BREMA ICE MAKERS
SPA
K00202:
ARISTARCO KASTEL
SPA



1137018 COMPRESS
ORE 1/3P HP MEDIA-
ALTA PRESSIONE
R404A /
COMPRESSOR 1/3P
RB00A798:
EURFRIGOR SRL
N23505: N.T.F. SRL
23578:
BREMA ICE MAKERS
SPA
23505:
BREMA ICE MAKERS
SPA
RB00A798:
EURFRIGOR ICE
MAKERS SRL



1137043 COMPRESS
ORE 1/2HP R404A
MEDIA-ALTA
PRESSIONE /
COMPRESSOR 1/2HP
R404A
23504A*:
BREMA ICE MAKERS
SPA



1137037 COMPRESS
ORE 1/2P R404A BASSA
PRESSIONE /
COMPRESSOR 1/2P
R404A LOW PRESSURE
23832:
BREMA ICE MAKERS
SPA



1137044 COMPRESS
 ORE 1/2P HP R404A
 MEDIA-ALTA
 PRESSIONE /
 COMPRESSOR 1/2P HP
 R404A
N23875: N.T.F. SRL
67010103:
SCOTSMAN ICE SRL



1137065 COMPRESS
 ORE 3/4 HP R404A
 BASSA PRESSIONE /
 COMPRESSOR 3/4 HP
 R404A LOW PRESSURE
R800B162:
EURFRIGOR SRL



1137138 COMPRESS
 ORE 1,5 HP NJ9238GK
 R404A /
 COMPRESSOR 1,5 HP
 NJ9238GK R404A
K04420:
**ARISTARCO KASTEL
 SPA**



1137066 COMPRESS
 ORE 1.3/8 HP R 404A
 ALTA PRESSIONE /
 COMPRESSOR 1.3/8 HP
 R 404A HIGH
 PRESSURE
23878:
**BREMA ICE MAKERS
 SPA**
CM19165552:
SCOTSMAN ICE SRL
CM19165552/0:
CASTEL MAC SPA
1RF099: MIGEL S.R.L.



1137021 COMPRESS
 ORE 1.5/8 R404A
 CAJ4519Z /
 COMPRESSOR
 CAJ4519Z
23543
**: BREMA ICE MAKERS
 SPA**
CM81453661/0:
CASTEL MAC SPA
N23543: N.T.F. SRL



1137137 COMPRESS
 ORE NJ2212GS 1,7HP
 380V BASSA
 TEMPERATURA R404A
 /
 COMPRESSOR
 NJ2212GS 1,7HP 380V
 LOW TEMPERATURE
 R404A



1137117 COMPRESS
 ORE AEZ1365Y R134
 V230 /
 COMPRESSOR
 AEZ1365Y R134 V230



1137014 COMPRESS
 ORE 1/6 HP ACC R134 /
 COMPRESSOR 1/6 HP
 ACC R134
67010507:
SCOTSMAN ICE SRL
67010002:
SCOTSMAN ICE SRL
CS0001581174:
SCOTSMAN ICE SRL



1137047 COMPRESS
 ORE 1/5HP R134A
 MEDIA-ALTA
 PRESSIONE /
 COMPRESSOR 1/5HP
 R134A
085876:
**ELECTROLUX
 PROFESSIONAL
 S.P.A.**
CM19165853/0:
CASTEL MAC SPA



1137015 COMPRESS
 ORE 1/4 HP ACC R134 /
 COMPRESSOR 1/4 HP
 ACC R134
67009708:
SIMAG SPA
BARLINE21:
SCOTSMAN ICE SRL



1137016 COMPRESS
 ORE 1/4P HP ACC R134 /
 COMPRESSOR 1/4 HP
 ACC R134
67010111:
SCOTSMAN ICE SRL
67010000:
SCOTSMAN ICE SRL



1137048 COMPRESS
 ORE 1/3P HP R134A
 MEDIA-ALTA
 PRESSIONE /
 COMPRESSOR 1/3P HP
 R134A
CM19165556/0:
CASTEL MAC SPA
67010100:
SCOTSMAN ICE SRL
67010106:
SCOTSMAN ICE SRL
67010001R:
SCOTSMAN ICE SRL



1137027 COMPRESS
OR CAJ4461 220/50 /
COMPRESSOR CAJ4461
220/50
67007605:
SCOTSMAN ICE SRL



1137146 COMPRESS
OR /
COMPRESSOR
1800872121:
SCOTSMAN ICE SRL



1137130 COMPRESS
OR230/60/1 /
COMPRESSOR230/60/1
67009909:
SCOTSMAN ICE SRL



1137025 COMPRESS
OR /
COMPRESSOR
1800883922:
SCOTSMAN ICE SRL



1137156 COMPRESS
ORE NJ9232GK
(R404)220/60 /
COMPRESSOR
NJ9232GK (R404) 220/60
23466:
**BREMA ICE MAKERS
SPA**
23874:
**BREMA ICE MAKERS
SPA**



1137164 COMPRESS
ORE (R404A) 220/50
CSR /
COMPRESSOR (R404A)
220/50 CSR
N231118: N.T.F. SRL
231118:
**BREMA ICE MAKERS
SPA**



1137120 COMPRESS
ORE CAE4450Y 3/8 134
230V /
COMPRESSOR
CAE4448Y 3/8 134 230V



1137106 COMPRESS
ORE SEMI-ERMETICO
DORIN H180CS HP1,8 /
COMPRESSOR DORIN
H180CS HP1,8



1137035 KIT PER
COMPRESSORE
FH4540Z 230/50 /
COMPRESSOR KIT
FH4540Z 230/50
KIT23647:
**BREMA ICE MAKERS
SPA**



1137022 COMPRESS
ORE + SENSORE
ACQUA CME506 /
COMPRESSOR +
WATER PROBE
CME506
02341021:
SCOTSMAN ICE SRL

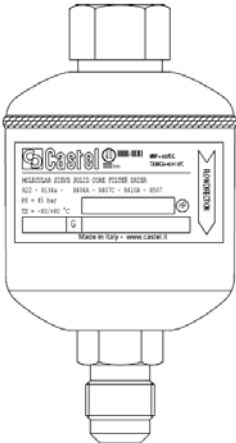

DISEGNO DRAWING	CODICE CODE	ATTACCHI SEA FLARE CONNECTIONS SEA FLARE	CUBATURA NOMINALE CM ³ NOMINAL VOLUME	NUMERO CASTEL CASTEL CODE
	3126263	1/4"	50 CM ³	4303/2
	3126264	3/8"	50 CM ³	4303/3
	3126245	1/4"	80 CM ³	4305/2
	3126265	3/8"	80 CM ³	4305/3
	3126266	1/4"	130 CM ³	4308/2
	3126267	3/8"	130 CM ³	4308/3
	3126268	1/2"	130 CM ³	4308/4
DISEGNO DRAWING	CODICE CODE	ATTACCHI SEA FLARE CONNECTIONS SEA FLARE	CUBATURA NOMINALE CM ³ NOMINAL VOLUME	NUMERO CASTEL CASTEL CODE
	3126262	1/4"	50 CM ³	4303/2F
	3126269	1/4"	80 CM ³	4305/2F
	3126270	1/4"	130 CM ³	4308/2F
	3126271	3/8"	130 CM ³	4308/3F
	3126272	3/8"	250 CM ³	4316/3F

3126064 FILTRO
ASPIRAZIONE POMPA /
PUMP SUCTION
FILTER
20005:
BREMA ICE MAKERS
SPA



3126550 AIR FILTER /
AIR FILTER
CM25339004:
SCOTSMAN ICE SRL
CM25339004/0:
CASTEL MAC SPA



DIMENSIONS
339X509mm

3126198 PANNELLO
FILTRANTE /
FILTER
18106:
BREMA ICE MAKERS
SPA

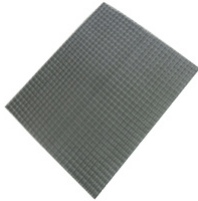

DIMENSIONS
230X190mm

3126551 FILTRO
ARIA CONDENSATORE
E21...3 5 /
CONDENSER FILTER
E21...35
CM25339014/0:
CASTEL MAC SPA

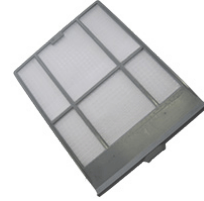

3126200 FILTRO /
FILTER
18178:
BREMA ICE MAKERS
SPA

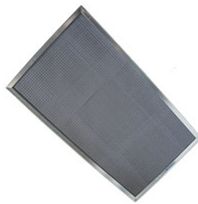

DIMENSIONS
635X360mm

3126313 AIRFILTER /
AIRFILTER
66088801:
SCOTSMAN ICE SRL

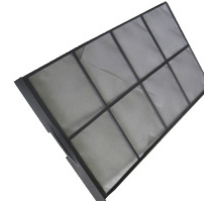

3126553 FILTRO
PIANO /
FILTER
18183:
BREMA ICE MAKERS
SPA
EU18183:
BRICE ITALIA SRL
N18183: N.T.F. SRL

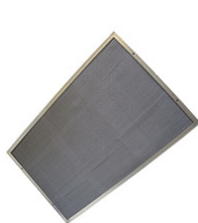

DIMENSIONS
708X440mm

3126318 AIR FILTER /
AIRFILTER
0200421201:
SCOTSMAN ICE SRL

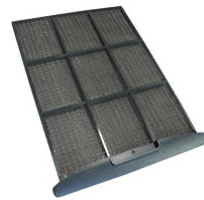

DIMENSIONS
237X334mm

3126233 FILTRO /
FILTER
18163:
BREMA ICE MAKERS
SPA

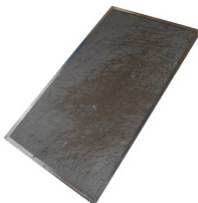

3126337 FILTRO
ARIA / AIR FILTER
66088500:
SCOTSMAN ICE SRL

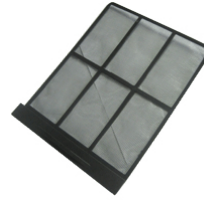

3126234 FILTRO /
FILTER
18166:
BREMA ICE MAKERS
SPA

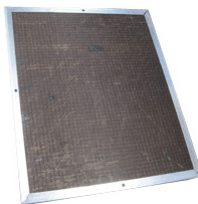

3126216 AIR FILTER /
AIR FILTER
0200348501:
SIMAG SPA
0200348501:
SCOTSMAN ICE SRL

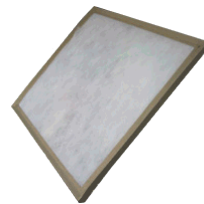

3126357 FILTRO
ARIA MOD.450/600 /
AIR FILTER MODEL
450/600
CM253390060:
CASTEL MAC SPA
RECOC515:
EURFRIGOR ICE
MAKERS SRL
CM25339006:
SCOTSMAN ICE SRL



3126543 SEDE
FILTRO ARIA /
AIR FILTER SEAT
66080400:
SCOTSMAN ICE SRL



3126241 FILTRO
10GR /
FILTER 10GR



RANGE, fino/until
1/6HP

3126242 FILTRO 15 GR /
FILTER 15GR



RANGE, 1/5 - 1/4 HP

3126240 FILTRO 20 GR /
FILTER 20 GR



RANGE, 1/3 - 1/2 HP

3126243 FILTRO 30GR /
FILTER 30 GR



RANGE, 3/4 - 1 HP

3126063 FILTRO MOLECOLARE 12GR /
MOLECULAR FILTER

085608:

ELECTROLUX PROFESSIONAL S.P.A.

14009:

BREMA ICE MAKERS SPA



3126227 FILTRO RAME GR. 20 X R 22 /
FILTER GR. 20X R 22

RF000546:

EURFRIGOR SRL

RF000546:

EURFRIGOR ICE MAKERS SRL



3126126 FILTRO MOLECOLARE /
MOLECULAR FILTER

63000305:

SCOTSMAN ICE SRL



3126283 FILTER /
FILTER

63000303:

SCOTSMAN ICE SRL



3126160 FILTRO SOLIDO 4305/2 1/4" ODS /
FILTER

14084: N.T.F. SRL

14084:

BREMA ICE MAKERS SPA



3126164 FILTRO CASTEL TIPO 4316/4 /
FILTER CASTEL 4316/4

CM19301252/0:

CASTEL MAC SPA



3126350 FILTRO CARTUCCIA SOL.4303/2S ATT.X D.6 /

FILTER CARTRIDGE SOL.4303/2S ATT.X D.6

CM193003570:

CASTEL MAC SPA



3126319 DRIER /
DRIER

0200331902:

SCOTSMAN ICE SRL



3126174 DRIER /
DRIER

0200331901:

SCOTSMAN ICE SRL



3126189 FILTRO ANTI-RADIODISTURBO /
ANTI-NOISE FILTER

C23457:

BREMA ICE MAKERS SPA



3126190 FILTRO ANTI-RADIODISTURBO /
ANTI-NOISE FILTER

C23459:

BREMA ICE MAKERS SPA

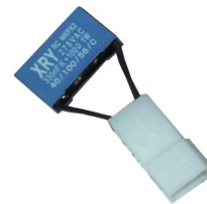

3126306 ANTIDISTURBO RC 047/220 400V /
ANTI-DISTURB FILTER RC 047/220 400V

EN07300:

OEM ALI SPA



3126286 ELECTR.

FILTER /
ELECTR. FILTER

62040412:

SCOTSMAN ICE SRL



3126218 FILTER /
FILTER

63013700:

SCOTSMAN ICE SRL



1143004 KIT ANALISI

DUREZZA ACQUA 0-
150MG/L /
WATER HARDNESS
TEST KIT



1143006 SIGILLANTE

RACCORDI PTFE 100ml

/
TEFLON PTFE
SEALING PASTE 100ml



1143020 ADESIVO

ISTANTANEO
MULTIUSO (f120gr) /
MULTIUSE
INSTANTANEOUS
ADHESIVE (f120gr)



1143021 LIQUIDO

SERRAFIETTI -
55°/+150° (tb50ml) /
TERMINAL-THREAD
LIQUID -55°/+150°
(tb50ml)



1143019 TUBO

GUARNIZIONE
LIQUIDA -55°/+200°
(75ml) /
LIQUID GASKET PIPE -
55°/+150° (75ml)



1143013 BARATTOL

O LOCTITE 55 /
LOCTITE POT 55



1143056 NASTRO

P.T.F.E. SPESSORE
12MT X 12mmX0,1 mm /
RIBBON P.T.F.E. 12MT
X 12mm x THICKNESS
0.1mm



1143062 GRASSO AL

SILICONE PTFE NSF
100G /
SILICONE OILY PTFE
NSF 100G



1143031 GRASSO

PER RIDUTTORE /
GREASE GEAR BOX

06029401:

SCOTSMAN ICE SRL

06029404:

SCOTSMAN ICE SRL

CMCF06029401:

CASTEL MAC SPA

CMCF06029404:

CASTEL MAC SPA



1143048 GREASE /
GREASE

CMCF26361200:

CASTEL MAC SPA

26361200:

SCOTSMAN ICE SRL



1143025 PULITORE

LUCIDANTE ACCIAIO
800ml -INOX CLEANER

/

STAINLESS STEEL
POLISHING CLEANER
800ML



1143009 SPRAY AIR

98 400ml /
SPRAY AIR 98 400ml



1143029 BARATTOL
O CC250 C/TAPPO /
POT CC250 WITH
STOPPER



1143017 CONFEZION
E S&P DS-CRT GR 1000
/
CALCIUM REMOVER
PACKING S&P DS-CRT
GR 1000



1143045 DISINCROST
ANTE ANTICALCARE
ALL'ACETO 500ML /
VINEGAR ANTI-
LIMESTONE SCALE-
REMOVER 500ML



1143018 CONFEZION
E S&P DT-ICE LT1 /
PACKING S&P DT-ICE
LT1



1143057 NEW
CLEANER-1 LT -
SCOTSMAN /
NEW CLEANER-1 LT -
SCOTSMAN
00100905:
SCOTSMAN ICE SRL



1143054 MINI
CLEANING KIT ICE
MAKERS /
MINI CLEANING KIT
ICE MAKERS
VAS92921:
BRICE ITALIA SRL



1143055 KIT
PULIZIA/SANITIZZAZI
ONE ICEMAKERS /
CLEANING KIT /
SANITIZATION
ICEMAKERS
KITSANITY:
BREMA ICE MAKERS
SPA



1143058 SANITIZER
(anti alga) /
SANITIZER
26400002:
SCOTSMAN ICE SRL



1143059 SCALEKLEEN
N CONFEZIONE 1 KG /
SCALEKLEEN
PACKAGE 1 KG



1143040 ACTIVATED
SCALE REMOVER 28 G
/
ACTIVATED SCALE
REMOVER 28 G



1143041 SCALE
KLEEN SCALE
REMOVER /
SCALE KLEEN SCALE
REMOVER



1143052 SANITISING
BAG /
SANITISING BAG
65090900:
SCOTSMAN ICE SRL



2101317 17,16X1,78
O-RING NBR /
O-RING NBR 17,16X1,78
27050:
HOONVED - ALI SPA
K01125: KASTEL SRL
200812:
COMENDA ALI SPA



2101416 55,25X2,62
O-RING NBR /
O-RING NBR 55,25X2,62
31948:
HOONVED - ALI SPA
20655:
BREMA ICE MAKERS
SPA
2010051000:
STAFF ICE SYSTEM
SRL



2101793 O RING /
O RING
64004110:
SCOTSMAN DIV.
FRIMONT SPA

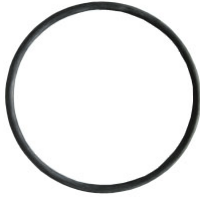

2101467 23,40X3,53
O-RING NBR /
O-RING NBR 23,40X3,53
64013400:
SCOTSMAN DIV.
FRIMONT SPA
PR75505: FABA SRL



2101487 49,20X3,53
O-RING NBR /
O-RING NBR 49,20X3,53
64004118:
SCOTSMAN
*:MBM
456061:
ELETTROBAR



2101388 17,13X2,62
O-RING NBR /
O-RING NBR 17,13X2,62
64008100:
SCOTSMAN
33798:
HOONVED - ALI SPA
9010005:
GRUPPO CIMBALI
DW13007:
DIHR-ALI SPA
OR122:
OMNIWASH SRL -
200819:
COMENDA ALI SPA



2101795 O RING /
O RING
64004113:
SCOTSMAN DIV.
FRIMONT SPA



2101138 O-RING
F100/120/200 /
O-RING F100/120/200
64008400:
SCOTSMAN DIV.
FRIMONT SPA
CF64008400:
CASTEL MAC SPA

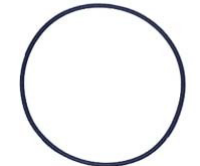

2101785 OR NERO
8X2 MM ALBERO
CENT.(SIS.
MAGNETICO) /
O-RING 8X2 MM
1002803217:
UGOLINI SPA



2101418 58,42X2,62
O-RING NBR /
O-RING NBR 58,42X2,62
1002802804:
UGOLINI SPA
047462:
ELECTROLUX
200852:
COMENDA ALI SPA



2101731 GUARNIZIO
NE PER FILTRO POMPA
/
PUMP FILTER GASKET
13080:
BREMA ICE MAKERS
SPA



2101173 GUARNIZIO
NE OR X TROPPO
PIENO /
SEAL OR X OVERFLOW
20233:
BREMA ICE MAKERS
SPA



2101089 GUARNIZIO
NE OR /
O-RING
64004120:
SCOTSMAN DIV.
FRIMONT SPA



2101865 GASKET /
GASKET
64014000:
SCOTSMAN DIV.
FRIMONT SPA



2101794 O RING /
O RING
64010100:
SCOTSMAN DIV.
FRIMONT SPA

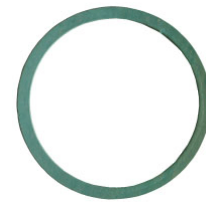

2101839 RING
GASKET W/SPRING /
RING GASKET
W/SPRING
64009706:
SCOTSMAN DIV.
FRIMONT SPA



2101762 GUARNIZIO
NE SILICONE PER
PISTONE RUBINETTO
OR123 /
O-RING
2280015100:
UGOLINI SPA





2101858 GUARNIZIO
NE OR 4325 /
SEAL OR 4325
N20987:
BREMA ICE MAKERS
SPA



2101210 GUARNIZIO
NE OR PER TROPPO
PIENO /
O-RING
20688:
BREMA ICE MAKERS
SPA



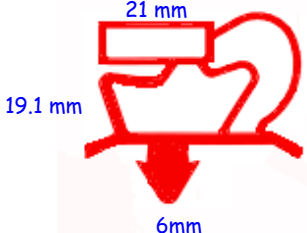

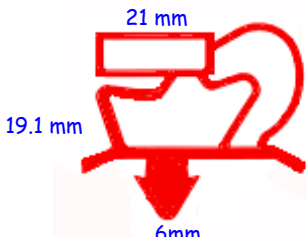
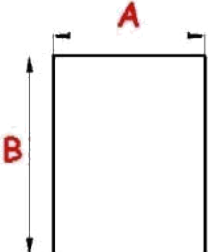
GUARNIZIONI MAGNETICHE AD INCASTRO / MAGNETIC SNAP-IN GASKETS

CODICE S&P – PROFILO GUARNIZIONE S&P CODE – GASKET PROFILE	DIMENSIONI ESTERNE MM EXTERNAL DIMENSIONS MM	ADATTABILITA' ADAPTABILITY
		
2103074	A = 2000 mm	2103074: UNIVERSALE
		
2103568	A=160mm, B=395mm	14414300149: POLARIS
2103612	A=198mm, B=398mm	2103612: TECNODOM
2103448	A=190mm, B=410mm	14414300200: POLARIS
2103122	A=195mm, B=360mm	*
2103405	A=195mm, B=445mm	75201200: MODULAR
2103086	A=200mm, B=390mm	FR925053: FRIULINOX
2103549	A=200mm, B=425mm	*
2103561	A=210mm, B=430mm	*
2103027	A=215mm, B=385mm	081772: ELECTROLUX 081772: ZANUSSI
2103571	A=225mm, B=400mm	*
2103533	A=265mm, B=425mm	*
2103161	A=275mm, B=385mm	082759: ELECTROLUX 082759: ZANUSSI
2103447	A=280mm, B=410mm	14414300290: POLARIS
2103323	A=280mm, B=480mm	*
2103339	A=290mm, B=485mm	*
2103570	A=290mm, B=400mm	*
2103157	A=300mm, B=410mm	FR925158: FRIULINOX
2103628	A=300mm, B=445mm	*
2103520	A=300mm, B=720mm	295100390: GICO
2103087	A=305mm, B=390mm	FR925054: FRIULINOX
2103670	A=305mm, B=445mm	75201300: MODULAR
2103269	A=309 mm, B=415 mm	14413090418: POLARIS

CODICE S&P – PROFILO GUARNIZIONE S&P CODE – GASKET PROFILE	DIMENSIONI ESTERNE MM EXTERNAL DIMENSIONS MM	ADATTABILITA' ADAPTABILITY
2103525	A=310mm, B=500mm	*
2103426	A=320mm, B=420mm	0102466: SILKO
2103560	A=330mm, B=430mm	*
2103073	A=335mm, B=385mm	081815: ZANUSSI
2103007	A=383mm, B=596mm	081805: ELECTROLUX 081805: ZANUSSI
2103661	A=385mm, B=555mm	*
2103011	A=385mm, B=585mm	082725: ELECTROLUX 082725: ZANUSSI
2103123	A=390mm, B=400mm	*
2103668	A=390mm, B=625mm	*
2103046	A=390mm, B=640mm	925052: FRIULINOX
2103683	A=397mm, B=485mm	GPS: TECNODOM
2103439	A=397mm, B=625mm	*
2103508	A=398mm, B=584mm	14414300569: POLARIS
2103404	A=398mm, B=648mm	GUTVPO: TECNODOM
2103528	A=400mm, B=600mm	*
2103136	A=402mm, B=628mm	R19099: ILSA
2103540	A=405mm, B=565mm	*
2103168	A=405mm, B=590mm	2103168: FRIULINOX
2103336	A=405mm, B=620mm	*
2103226	A=405mm, B=675mm	14416600390: POLARIS
2103355	A=405mm, B=710mm	*
2103437	A=407mm, B=492mm	*
2103302	A=410 mm, B=580 mm	14414300620: POLARIS
2103436	A=410mm, B=615mm	*
2103536	A=410mm, B=726mm	26107202/0: ICEMATIC
2103081	A=415mm, B=530mm	144140020516: POLARIS
2103199	A=418mm, B=418mm	14414180418: POLARIS
2103131	A=418mm, B=640mm	14414180640: POLARIS
2103412	A=420mm, B=633mm	827879: EMMEPI
2103325	A=420mm, B=660mm	37Q4490: ANGELO PO
2103308	A=420mm, B=667mm	1010101: IRINOX
2103550	A=425mm, B=425mm	*
2103534	A=425mm, B=595mm	*
2103294	A=425mm, B=615mm	2103294: C&D
2103562	A=430mm, B=450mm	*
2103126	A=430mm, B=640mm	FR925104: FRIULINOX
2103337	A=430mm, B=680mm	2103337: IFI
2103326	A=445mm, B=600mm	*
2103462	A=445mm, B=610mm	*
2103413	A=450mm, B=710mm	*

CODICE S&P – PROFILO GUARNIZIONE S&P CODE – GASKET PROFILE	DIMENSIONI ESTERNE MM EXTERNAL DIMENSIONS MM	ADATTABILITA' ADAPTABILITY
2103527	A=460mm, B=630mm	*
2103056	A=460mm, B=640mm	2103056: OLIS
2103322	A=465mm, B=725mm	*
2103582	A=465mm, B=575mm	*
2103301	A=465mm, B=595mm	0A8992: ELECTROLUX
2103441	A=472mm, B=625mm	*
2103124	A=478mm, B=628mm	R19098: ILSA
2103401	A=480mm, B=590mm	*
2103174	A=480mm, B=598mm	2103174: FRIULINOX
2103483	A=480mm, B=635mm	*
2103338	A=485mm, B=685mm	*
2103424	A=490mm, B=630mm	*
2103207	A=490mm, B=650mm	2103207: GEMM
2103526	A=495mm, B=590mm	*
2103588	A=495mm, B=760mm	*
2103481	A=498mm, B=639mm	2103481: OLIS
2103535	A=500mm, B=600mm	*
2103303	A=500mm, B=615mm	2103303: C&D
2103396	A=500mm, B=690mm	2103396: POLARIS/OLIS
2103397	A=510mm, B=633mm	2103397: EMMEPI
2103689	A=515mm, B=1520mm	*
2103598	A=540mm, B=540mm	*
2103341	A=565mm, B=1495mm	*
2103392	A=570mm, B=745mm	*
2103385	A=570mm, B=1470mm	14415601460: POLARIS/OLIS
2103664	A=575mm, B=685mm	*
2103200	A=582 mm, B=1482mm	2103200: C&D
2103587	A=585mm, B=1053mm	*
2103304	A=590mm, B=635mm	FR925057: FRIULINOX
2103351	A=605mm, B=1600mm	F37Q1020: GIGA GRANDI CUCINE SRL
2103622	A=610mm, B=750mm	14415990738: POLARIS/BARON
2103543	A=610mm, B=1570mm	*
2103225	A=615mm, B=1575mm	14416451606: POLARIS/BARON
2103444	A=618mm, B=1564mm	14415991559: POLARIS/BARON
2103349	A=625mm, B=730mm	*
2103445	A=627mm, B=1541mm	75201900: MODULAR
2103634	A=630mm, B=840mm	*
2103066	A=630mm, B=1490mm	7531005: IRF- C&D-FIOCCHETTI
2103329	A=630mm, B=1560mm	*
2103453	A=631mm, B=1474mm	02517800R: EUROTEC SRL
2103497	A=635mm, B=1525mm	*

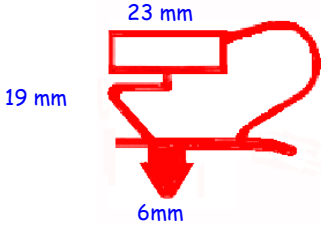
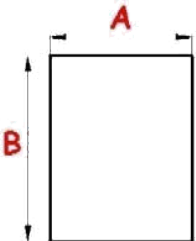
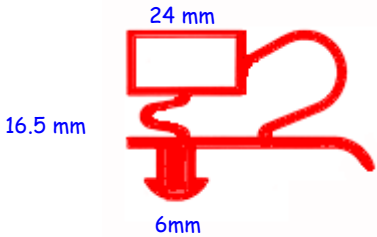
CODICE S&P – PROFILO GUARNIZIONE S&P CODE – GASKET PROFILE	DIMENSIONI ESTERNE MM EXTERNAL DIMENSIONS MM	ADATTABILITA' ADAPTABILITY
2103600	A=635mm, B=1835mm	*
2103692	A=640mm, B=1690mm	*
2103476	A=645mm, B=1560mm	*
2103592	A=646mm, B=1552mm	6106461552: COLDLINE
2103559	A=655mm, B=695mm	*
2103237	A=655mm, B=1555mm	2103237: MODULAR
2103096	A=660mm, B=735mm	082424: ELECTROLUX
2103019	A=660mm, B=1530mm	082375: ELECTROLUX 082375: ZANUSSI
2103243	A=660mm, B=1550mm	081943: ELECTROLUX
2103101	A=660mm, B=1555mm	R18565:ILSA
2103261	A=660mm, B=1622mm	14416451605: POLARIS/OLIS
2103478	A=665mm, B=1350mm	*
2103680	A=668mm, B=1588mm	*
2103479	A=670mm, B=770mm	2103479: DESMON
2103257	A=670mm, B=1568mm	2103257: GELART
2103072	A=670mm, B=1570mm	1570X670 ILSA: FRIULINOX
2103382	A=670mm, B=1610mm	*
2103513	A=675mm, B=1545mm	*
2103330	A=675mm, B=1580mm	*
2103082	A=675mm, B=1594mm	14416761594: POLARIS/OLIS
2103049	A=676mm, B=784mm	2103049: OLIS
2103048	A=676mm, B=1594mm	2103048: OLIS
2103578	A=685mm, B=740mm	*
2103286	A=685mm, B=780mm	37Q2600: ANGELO PO
2103579	A=685mm, B=1515mm	*
2103083	A=685mm, B=1600mm	37Q2590: ANGELO PO
2103102	A=690mm, B=1525mm	FR935306: FRIULINOX
2103647	A=690mm, B=1540mm	*
2103381	A=690mm, B=1650mm	*
2103394	A=695mm, B=1050mm	14416801032: POLARIS/OLIS
2103075	A=695mm, B=1600mm	14416801580: POLARIS/OLIS
2103130	A=695mm, B=775mm	14416800759: POLARIS/OLIS
2103663	A=705mm, B=1590mm	*
2103267	A=708mm, B=1500mm	081724: ELECTROLUX
2103693	A=710mm, B=837mm	*
2103511	A=710mm, B=1924mm	*
2103231	A=713mm, B=1036mm	26107203/0: ICEMATIC
2103229	A=715mm, B=795mm	14417000780: POLARIS/OLIS
2103597	A=720mm, B=1715mm	*
2103662	A=730mm, B=1165mm	R27573: ILSA

CODICE S&P – PROFILO GUARNIZIONE S&P CODE – GASKET PROFILE	DIMENSIONI ESTERNE MM EXTERNAL DIMENSIONS MM	ADATTABILITA' / ADAPTABILITY
2103691	A=730mm, B=1550mm	*
2103572	A=730mm, B=1620mm	*
2103700	A=735mm, B=1050mm	193520080 /O: ICEMATIC
2103321	A=740mm, B=1730mm	*
2103620	A=745mm, B=1710mm	*
2103320	A=745mm, B= 1865mm	14417321850: POLARIS/OLIS
2103420	A=749mm, B=923mm	*
2103586	A=755mm, B=1085mm	*
2103684	A=770mm, B=1295mm	*
2103655	A=775mm, B=1145mm	26100379/0: ICEMATIC
2103633	A=1015mm, B=1943mm	*
		
2103430	A=260mm, B=385mm	37Q3950: ANGELO PO 37Q4720: ANGELO PO
2103590	A=310mm, B=480mm	*
2103557	A=384mm, B=582mm	37Q4710: ANGELO PO 37Q4710: MBM
2103491	A=390mm, B=650mm	37Q5330: ANGELO PO
2103591	A=480mm, B=645mm	*
2103674	A=538mm, B=1508mm	37Q5510: ANGELO PO
2103675	A=602mm, B=1508mm	37Q5590: ANGELO PO
2103403	A=605mm, B=1595mm	37Q4850: ANGELO PO
2103327	A=665mm, B=765mm	37Q4470: ANGELO PO
2103239	A=665mm, B=1615mm	37Q4370: ANGELO PO
2103716	A=668mm, B=716mm	37Q5460: ANGELO PO
2103177	A=668mm, B=1508mm	37Q5450: ANGELO PO
		

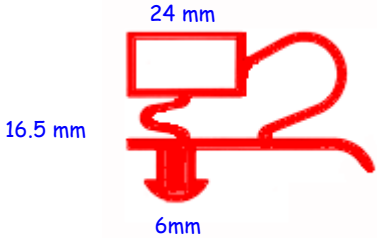
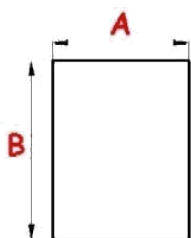
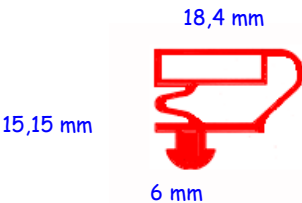
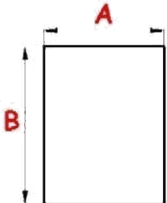
CODICE S&P – PROFILO GUARNIZIONE S&P CODE – GASKET PROFILE	DIMENSIONI ESTERNE MM EXTERNAL DIMENSIONS MM	ADATTABILITA' ADAPTABILITY
2103057	A = 2000 mm	
		
2103125	A=150mm, B=385mm	37Q7730: ANGELO PO
2103573	A=215mm, B=375mm	*
2103574	A=370mm, B=615mm	*
2103575	A=375mm, B=620mm	*
2103089	A=385mm, B=260mm	37Q7690: ANGELO PO
2103218	A=385mm, B=580mm	37Q7590: ANGELO PO
2103045	A=590mm, B=1465mm	97750010: IRF- C&D-FIOCCHETTI
2103044	A=620mm, B=1465mm	2103044: IRF- C&D-FIOCCHETTI
2103509	A=630mm, B=1565mm	*
2103352	A=647mm, B=1613mm	2103352: ISA
2103411	A=651mm, B=741mm	28068: EVERLASTING
2103116	A=655mm, B=755mm	37Q2010: ANGELO PO
2103059	A=663mm, B=1570mm	9775001: IRF- C&D-FIOCCHETTI
2103079	A=663 mm, B=760mm	2103079: FIOCCHETTI
2103117	A=664mm, B=1565mm	2103117: IBERNA
2103063	A=665mm, B=1560mm	37Q1890: ANGELO PO
2103118	A=665 mm, B=770 mm	2103118: IBERNA
2103098	A=670mm, B= 1530mm	37Q0210: ANGELO PO
2103162	A=690mm, B=1475mm	0A8365: ELECTROLUX
2103510	A=690mm, B=1600mm	*
2103638	A=895mm, B=1890mm	*
		
2103632	A=175mm, B=430mm	*
2103259	A=265mm, B=400mm	2103259: OLIS
2103495	A=280mm, B=400mm	*
2103529	A=295mm, B=425mm	2103529: STUDIO 54
2103473	A=355mm, B=415mm	*
2103642	A=400mm, B=600mm	*
2103258	A=400mm, B=615mm	2103258: OLIS

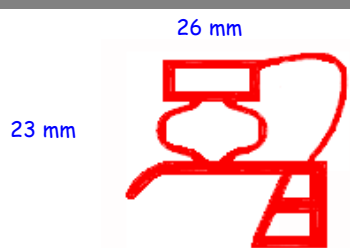
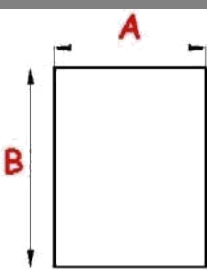
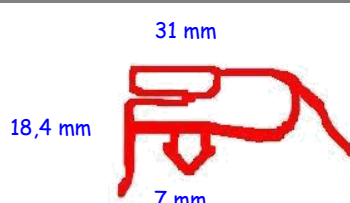
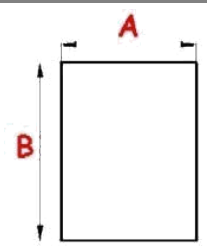

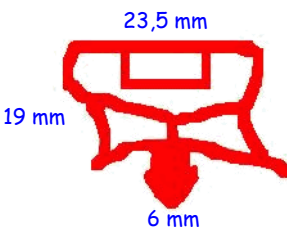
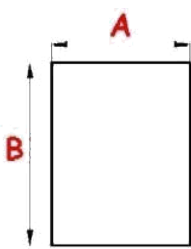
CODICE S&P – PROFILO GUARNIZIONE S&P CODE – GASKET PROFILE	DIMENSIONI ESTERNE MM EXTERNAL DIMENSIONS MM	ADATTABILITA' ADAPTABILITY
2103472	A=415mm, B=613mm	*
2103653	A=425mm, B=620mm	2103653: STUDIO 54
2103222	A=425mm, B=632mm	2103222: ISA
2103379	A=445mm, B=600mm	2103379: OLIS
2103427	A=456mm, B=514mm	2103427: AFINOX
2103195	A=462mm, B=592mm	2103195: AFINOX
2103515	A=465mm, B= 655mm	*
2103621	A=470mm, B=620mm	*
2103419	A=485mm, B=620mm	2103419: STUDIO 54 19352010/0: ICEMATIC
2103539	A=485mm, B=715mm	*
2103201	A=490mm, B=670mm	2103201: ALASKA
2103542	A=645mm, B=1570mm	*
2103690	A=650mm. B=1550mm	*
2103477	A=656mm, B=1585mm	2103477: AFINOX
2103589	A=662mm, B=1555mm	2103589: AFINOX
2103723	A=666mm, B=1536mm	082586: ELECTROLUX
2103151	A=666mm, B=1563mm	2103151: AFINOX
2103221	A=690mm, B=1570mm	2103221: ISA
2103388	A=862mm, B=1562mm	*
		
2103085	A=300mm, B=395mm	MA2500712: MARENO INDUSTRIE ALI
2103084	A=395mm, B=620mm	MA2500912: MARENO INDUSTRIE ALI
2103014	A=670mm, B=765mm	MA2304414: MARENO INDUSTRIE ALI
2103001	A=670mm, B=1560mm	2304500: MARENO INDUSTRIE ALI SPA
		
2103669	A=397mm. B=595mm	0A9565: ELECTROLUX
2103211	A=411mm, B=582mm	089183: ELECTROLUX
2103518	A=520mm, B=1640mm	4612040: MONDIAL
2103649	A=530mm, B=635mm	*
2103309	A=566mm, B=1695mm	2103309: MONDIAL



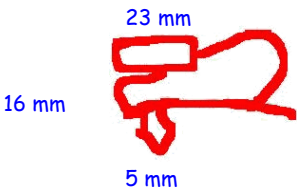
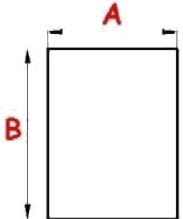

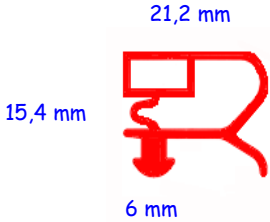
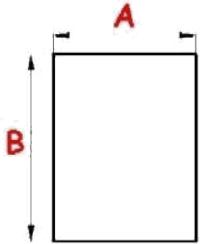
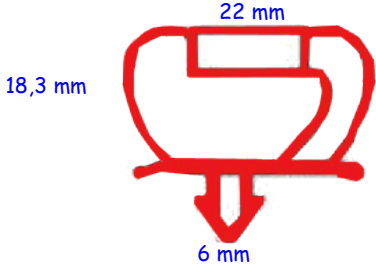

CODICE S&P – PROFILO GUARNIZIONE S&P CODE – GASKET PROFILE	DIMENSIONI ESTERNE MM EXTERNAL DIMENSIONS MM	ADATTABILITA' ADAPTABILITY
2103496	A=570mm, B=745mm	4612135: MONDIAL
2103206	A=590mm, B=685mm	087451: ELECTROLUX 087451: ZANUSSI
2103165	A=598mm, B=1690mm	087357: ZANUSSI
2103499	A=610mm, B=1327mm	02209200: EUROTEC SRL
2103006	A=612mm, B=1699mm	0A9099: ZANUSSI
2103189	A=641mm, B=1535mm	8C2123: EMMEPI
2103454	A=655mm; B=1495mm	R_34516: ILSA
2103138	A=664mm, B=1570mm	0A8225: ELECTROLUX ALPOA8225: EUROTEC SRL
2103233	A=665mm, B=760mm	0A8230: ELECTROLUX
2103639	A=685mm, B=1475mm	*
2103205	A=685mm, B=1531mm	085719: ELECTROLUX 085719: ZANUSSI
2103179	A=690mm, B=1550mm	RIC0002903: EUROTEC SRL 01153500R: DEXION
2103494	A=695mm, B=1495mm	R_34518: ILSA
2103531	A=698mm, B=1538mm	R_31262: ILSA
2103410	A=705mm, B=1637mm	4612041: MONDIAL
2103288	A=741mm, B=1705mm	4612118: MONDIAL
		
2103563	A=210mm, B=530mm	*
2103565	A=230mm, B=530mm	*
2103305	A=266mm, B=422mm	6015004000: COLDLINE
2103273	A=270mm, B=405mm	087691: ELECTROLUX
2103438	A=285mm, B=410mm	*
2103365	A=290mm, B=485mm	925315: FRIULINOX
2103709	A=358mm, B=714mm	2103709: FRIULINOX
2103299	A=368mm, B=658mm	6506580368: COLDLINE
2103654	A=382mm, B=462mm	965122: FRIULINOX
2103272	A=405mm, B=570mm	087664: ZANUSSI
2103679	A=406mm, B=666mm	*
2103500	A=410mm, B=597mm	925281: FRIULINOX
2103537	A=415mm, B=585mm	099531: ZANUSSI
2103475	A=420mm, B=710mm	FR996453: HIBER
2103710	A=422mm, B=600mm	*
2103228	A=423mm, B=682mm	083377: ELECTROLUX 083377: ZANUSSI

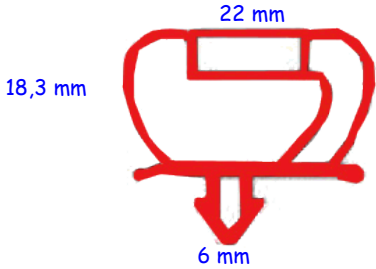
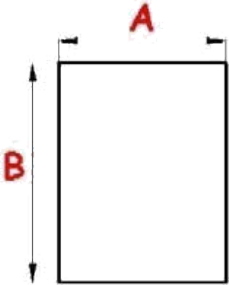
CODICE S&P – PROFILO GUARNIZIONE S&P CODE – GASKET PROFILE	DIMENSIONI ESTERNE MM EXTERNAL DIMENSIONS MM	ADATTABILITA' ADAPTABILITY
2103306	A=433mm, B=608mm	6504330608: COLDLINE
2103685	A=433mm, B=653mm	6504330653: COLDLINE
2103596	A=470mm, B=650mm	*
2103440	A=485mm, B=618mm	099531: ELECTROLUX
2103367	A=485mm, B=635mm	R_36471: ILSA
2103461	A=485mm, B=645mm	BN14415396405: POLARIS/OLIS
2103360	A=490mm, B=516mm	089689: ELECTROLUX
2103627	A=496mm, B=663mm	2103309: GEMM
2103307	A=508mm, B=608mm	6505080608: COLDLINE
2103564	A=530mm, B=600mm	*
2103606	A=585mm, B=1535mm	BN14415991560: POLARIS/OLIS
2103380	A=590mm, B=680mm	925432:FRIULINOX
2103619	A=590mm, B=740mm	BN1441571718: POLARIS/OLIS
2103569	A=595mm, B=740mm	*
2103658	A=620mm, B=1580mm	*
2103648	A=642mm, B=746mm	*
2103266	A=642mm, B=1512mm	089735: ELECTROLUX
2103183	A=645mm, B=705mm	0A9741: ELECTROLUX
2103707	A=650mm, B=1500mm	*
2103548	A=654mm, B=1564mm	6506581564: COLDLINE
2103517	A=665mm, B=1560mm	2103517: AFINOX
2103667	A=665mm, B=1585mm	*
2103182	A=690mm, B=750mm	2103182: BARON 2103182:FRIULINOX
2103212	A=690mm, B=755mm	083397: ELECTROLUX 083397: ZANUSSI
2103488	A=700mm, B=1550mm	*
2103717	A=710mm, B=870mm	4501512:FRIULINOX
2103414	A=728mm, B=1564mm	6506581564: COLD LINE
2103208	A = 2000 mm	
2103718	A=210mm, B=430mm	*

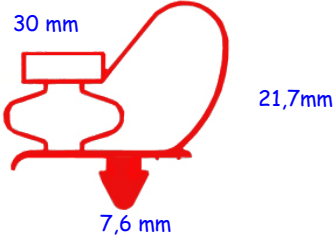
CODICE S&P – PROFILO GUARNIZIONE S&P CODE – GASKET PROFILE	DIMENSIONI ESTERNE MM EXTERNAL DIMENSIONS MM	ADATTABILITA' ADAPTABILITY
2103408	A=295mm, B=425mm	2103408: DESMON
2103719	A=330mm, B=430mm	*
2103629	A=392mm, B=739mm	*
2103616	A=410mm, B=660mm	*
2103720	A=430mm, B=440mm	*
2103722	A=430mm, B=680mm	*
2103721	A=464mm, B=630mm	*
2103498	A=420mm, B=590mm	*
2103484	A=420mm, B=725mm	*
2103202	A=425mm, B=630mm	75202700: MODULAR
2103485	A=470mm, B=660mm	*
2103665	A=475mm, B=620mm	*
2103516	A=500mm, B=625mm	*
2103292	A=505mm, B=655mm	*
2103317	A=505mm, B=654mm	*
2103277	A=525mm, B=625mm	2103277: DESMON
2103492	A=540mm, B=775mm	*
2103493	A=575mm, B=1010mm	*
2103608	A=580mm, B=1570mm	*
2103607	A=580mm, B=1630mm	*
2103507	A=600mm, B=1600mm	*
2103409	A=655mm, B=750mm	2103409: DESMON
2103197	A=655mm, B=1550mm	2103197: DESMON 807830: EMMEPI GRANDI CUCINE S.R.L.
2103611	A=661mm, B=1422mm	4410112860000: MONDIAL ELITE 4410112860000: FRAMEC
2103425	A=665mm, B=760mm	TDE072171: MONDIAL ELITE
2103180	A=665mm, B=1365mm	2103309: IBERNA
2103235	A=670mm, B=1600mm	2103235: DESMON
2103676	A=674mm, B=1645mm	330068: UNIFRIGOR
2103609	A=725mm, B=1640mm	*
2103097	A=740mm, B=1619mm	2103097: IARP
2103688	A=775mm, B=1635mm	*
		
2103637	A=415mm, B=575mm	*
2103555	A=500mm, B=660mm	80007247: MACH
2103708	A=530mm, B=640mm	*

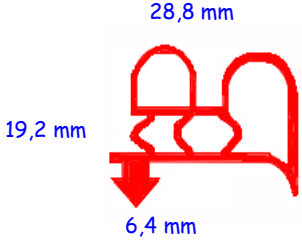
CODICE S&P – PROFILO GUARNIZIONE S&P CODE – GASKET PROFILE	DIMENSIONI ESTERNE MM EXTERNAL DIMENSIONS MM	ADATTABILITA' ADAPTABILITY
2103247	A=550mm, B=1722mm	2103247: IARP
2103387	A=558mm, B=1713mm	0313007: IARP
2103704	A=575mm, B=1605mm	0313225: IARP
2103191	A=630mm, B=1532mm	2103191: IARP
2103395	A=634mm, B=1391mm	2103395: IARP
2103530	A=645mm, B=1315mm	*
2103512	A=650mm, B=1320mm	*
2103551	A=652mm, B=1320mm	4612087: MONDIAL ELITE
2103490	A=685mm, B=1640mm	*
2103181	A=707mm, B=770mm	CM28175018: SCOTSMAN 28175018/O: ICEMATIC
2103020	A=715mm, B=1580mm	CM28175017: SCOTSMAN W7ONT, W7ONTV: ICEMATIC
2103698	A=730mm, B=1680mm	0313291: IARP
2103256	A=720mm, B=1515mm	2103256: IARP
2103521	A=730mm, B=1640mm	2103521: STAR 10
2103620	A=1010mm, B=1940mm	*
2103100	A=2200mm	
2103384	A=655mm, B=738mm	2103384: SURFRIGO
2103143	A=665mm, B=1540mm	2103143: SURFRIGO
2103291	A=2000mm	2103291: EVERLASTING

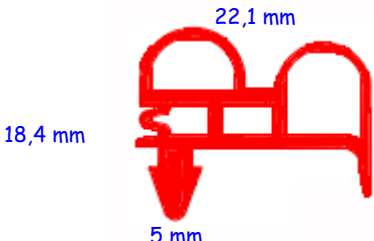
CODICE S&P – PROFILO GUARNIZIONE S&P CODE – GASKET PROFILE	DIMENSIONI ESTERNE MM EXTERNAL DIMENSIONS MM	ADATTABILITA' ADAPTABILITY
		
2103460	A=185mm, B=423mm	2103460: EVERLASTING
2103505	A=290mm, B=495mm	2103505: EVERLASTING
2103214	A=295mm, B=423mm	2103214: EVERLASTING
2103667	A=306mm, B=398mm	2103667: EVERLASTING
2103416	A=398mm, B=635mm	2103416: EVERLASTING
2103213	A=423mm, B=620mm	2103213: EVERLASTING
2103610	A=425mm, B=625mm	*
2103502	A=495mm, B=655mm	*
2103503	A=498mm, B=621mm	2103503: EVERLASTING
2103144	A=590mm, B=1515mm	2103144: ENOFRIGO
2103421	A=610mm, B=770mm	2103421: EVERLASTING
2103223	A=651mm, B=1551mm	28067: EVERLASTING
		
2103230	A=2000mm	
		
2103244	A=670mm, B=1570mm	080959: ZANUSSI
2103635	A=705mm, B=730mm	*
2103636	A=710mm. B=1490mm	*

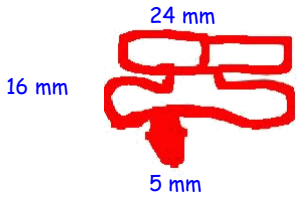
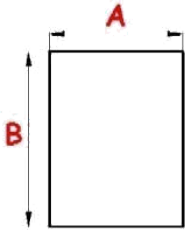
CODICE S&P – PROFILO GUARNIZIONE S&P CODE – GASKET PROFILE	DIMENSIONI ESTERNE MM EXTERNAL DIMENSIONS MM	ADATTABILITA' ADAPTABILITY
		
<p>2103455</p>	<p>A=2000mm</p>	<p>2103503: FAGOR</p>
		
<p>2103240</p>	<p>A=2500mm</p>	<p>2103240: EVERLASTING 2103240: CRIOCABIN</p>
		
<p>2103374</p>	<p>A=2000mm</p>	<p>2103374: MODULAR 2103374: BOSTON</p>
		
<p>2103443</p>	<p>A=562mm, B=1699mm</p>	<p>4612146: MONDIAL ELITE</p>
<p>2103465</p>	<p>A=570mm, B=1445mm</p>	<p>4612070: MONDIAL ELITE</p>
<p>2103519</p>	<p>A=570mm, B=1562mm</p>	<p>4612160: MONDIAL ELITE</p>
<p>2103331</p>	<p>A=570mm, B=1695mm</p>	<p>2103331: MONDIAL ELITE</p>
<p>2103442</p>	<p>A=575mm, B=1700mm</p>	<p>4612112: MONDIAL ELITE</p>
<p>2103241</p>	<p>A=575mm, B=1715mm</p>	<p>4612138: MONDIAL ELITE</p>
<p>2103290</p>	<p>A=745mm, B=1705mm</p>	<p>4612139: MONDIAL ELITE</p>
<p>2103428</p>	<p>A=775mm, B=1705mm</p>	<p>4612068: MONDIAL ELITE</p>



CODICE S&P – PROFILO GUARNIZIONE S&P CODE – GASKET PROFILE	DIMENSIONI ESTERNE MM EXTERNAL DIMENSIONS MM	ADATTABILITA' ADAPTABILITY
2103297	A=385mm, B=580mm	6045010119: FAGOR 12038156: FAGOR
2103332	A=460mm, B=580mm	12035412: FAGOR
2103697	A=636mm, B=1457mm	12038148: FAGOR
2103232	A=400mm, B=605mm	6001401101: FAGOR
2103279	A=475mm, B=605mm	6001401104: FAGOR
2103605	A=636mm, B=736mm	6045010013: FAGOR
2103501	A=636mm, B=1520mm	6045010030: FAGOR
2103417	A=395mm, B=645mm	*
2103319	A=415mm, B=630mm	*
2103645	A=400mm, B=550mm	*
2103532	A=445mm, B=645mm	2103532: DEXION

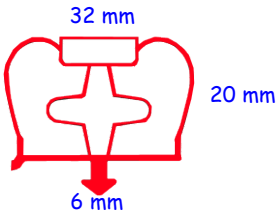
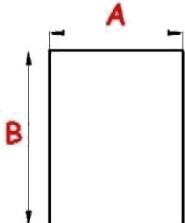

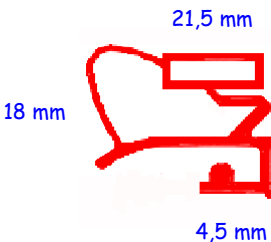
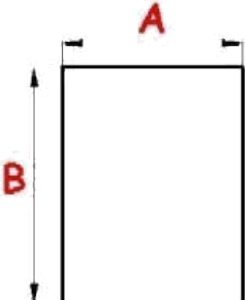
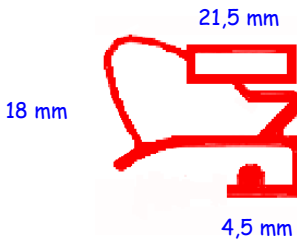
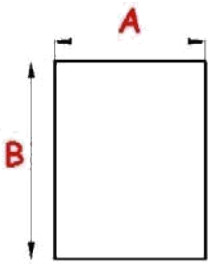

CODICE S&P – PROFILO GUARNIZIONE S&P CODE – GASKET PROFILE	DIMENSIONI ESTERNE MM EXTERNAL DIMENSIONS MM	ADATTABILITA' ADAPTABILITY
2103547	A=633mm, B=1520mm	2103547: FRIGOVELL
2103681	A=647mm, B=1500mm	2103681: FRIGOVELL
2103603	A=678mm, B=1570mm	*
2103099	A=2000mm	2103099: FOSTER
2103615	A=870mm, B=1950mm	*
2103641	A=270mm, B=500mm	*
2103640	A=470mm, B=600mm	*
2103617	A=955mm, B=1550mm	2103617: STAR 10
2103652	A=636mm, B=736mm	*
2103651	A=636mm, B=1520mm	*

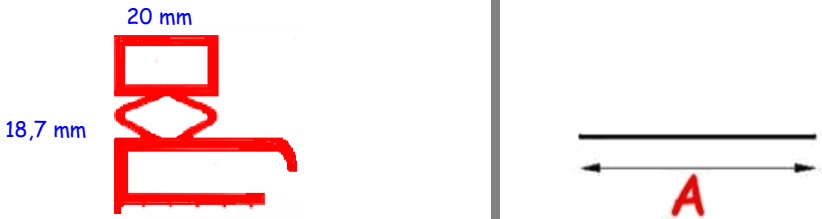
CODICE S&P – PROFILO GUARNIZIONE S&P CODE – GASKET PROFILE	DIMENSIONI ESTERNE MM EXTERNAL DIMENSIONS MM	ADATTABILITA' ADAPTABILITY
2103678	A=610mm, B=765mm	094153: ELECTROLUX
2103725	A=610mm, B=1595mm	094152: ELECTROLUX
		
2103695	A=530mm, B=602mm	2103695: INFRICO
2103682	A=660mm, B=1565mm	2103682: INFRICO

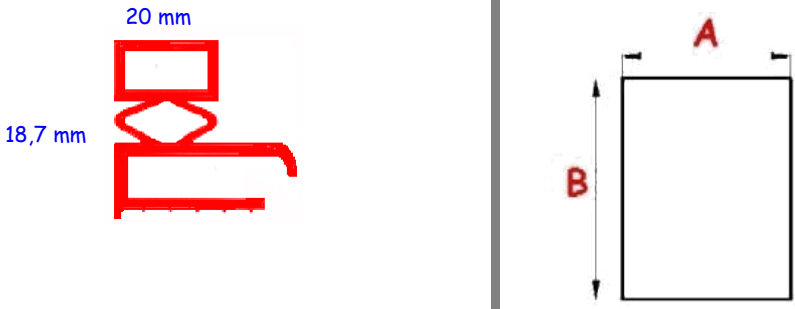
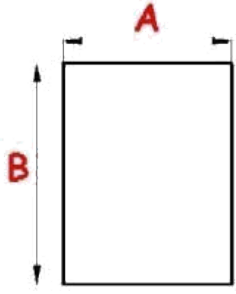

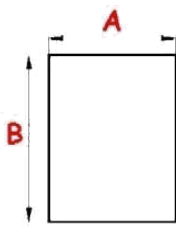

GUARNIZIONI MAGNETICHE MEZZOBORDO / MAGNETIC MIDDLE-EDGED GASKETS

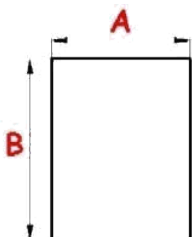









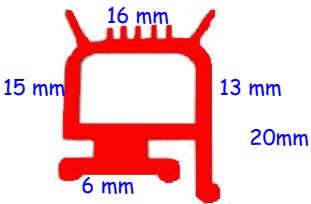

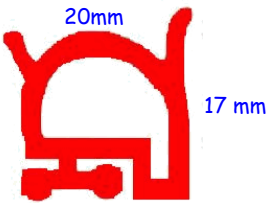
CODICE S&P – PROFILO GUARNIZIONE S&P CODE – GASKET PROFILE	DIMENSIONI ESTERNE MM EXTERNAL DIMENSIONS MM	ADATTABILITA' / ADAPTABILITY
		
2103147	A=1000mm, B=2000mm	
		
2103545	A=280mm, B=390mm	*
2103346	A= 280mm, B=475mm	6045010118: FAGOR INDUSTRIALE S.R.L.
2103558	A=300mm, B=385mm	*
2103017	A=310mm, B= 390mm	0A8079: ELECTROLUX 01236300R: DEXION 0A8079: ZANUSSI
2103390	A=370mm, B=400mm	RIC0000902:EUROTEC DIVISIONE MBM
2103544	A=390mm, B=435mm	0A8081: ELECTROLUX
2103344	A=390mm, B=634mm	925013: FRIULINOX
2103018	A=390mm, B=640mm	RIC0002983: EUROTEC SRL 0A8075: ELECTROLUX 01236400R: DEXION 0A8075: ZANUSSI
2103347	A=410mm, B=650mm	2103347: EUROTEC SRL
2103324	A=450mm, B=620mm	*
2103541	A=465mm, B=690mm	*
2103701	A=490mm, B=780mm	*
2103345	A=491mm, B=531mm	0A8318: ELECTROLUX 0A8318: ZANUSSI
2103285	A=495mm, B=635mm	01710600: DEXION
2103613	A=540mm, B=678mm	01288801R: DEXION
2103552	A=560mm, B=580mm	*
2103626	A=565mm, B=585mm	*
2103625	A=565mm, B=785mm	*

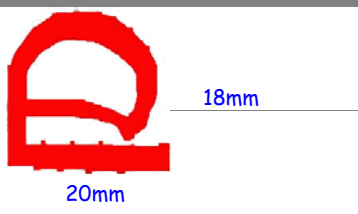

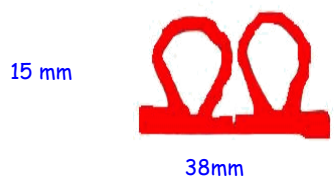

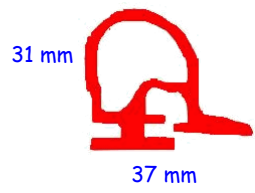

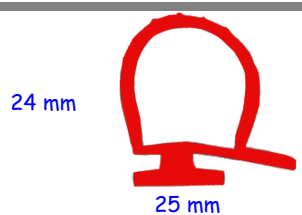





CODICE S&P – PROFILO GUARNIZIONE S&P CODE – GASKET PROFILE	DIMENSIONI ESTERNE MM EXTERNAL DIMENSIONS MM	ADATTABILITA' / ADAPTABILITY
2103554	A=590mm, B=650mm	*
2103271	A=660mm, B=1540mm	0A8369: ELECTROLUX 0A8369: ZANUSSI
2103015	A=670mm, B=770mm	081294: ELECTROLUX 081294: ZANUSSI 0A8049: ALPENINOX
2103016	A=670mm, B=1570mm	2103016: MARENO INDUSTRIE ALI SPA 081293: ELECTROLUX 081293: ZANUSSI 0A8048: ALPENINOX
2103673	A=700mm, B=1100mm	*
2103644	A=725mm, B=870mm	*
		
2103340	A=2000mm	*
		
2103093	A=295mm, B=385 mm	37Q2050: ANGELO PO
2103449	A=308mm, B=388mm	2103449: EVERLASTING
2103583	A=350mm, B=627mm	*
2103094	A=385 mm, B=610 mm	37Q2040: ANGELO PO
2103236	A=388mm, B=636 mm	2103236: EVERLASTING
2103335	A=440mm, B=560 mm	*
2103031	A=580mm, B=610 mm	37Q0470: ANGELO PO
2103078	A=620mm, B=1530mm	2103078: EVERLASTING
2103702	A=630mm, B=700mm	*
2103703	A=630mm, B=1440mm	*
2103032	A=660mm, B=1360mm	37Q0450: ANGELO PO

CODICE S&P – PROFILO GUARNIZIONE S&P CODE – GASKET PROFILE	DIMENSIONI ESTERNE MM EXTERNAL DIMENSIONS MM	ADATTABILITA' ADAPTABILITY
<p>18,25mm</p> <p>16,2 mm</p> 		
<p>2103489</p>	<p>A=280mm, B=1020mm</p>	<p>*</p>
<p>20,5 mm</p> <p>16,5 mm</p> 		
<p>2103242</p>	<p>A=2000mm</p>	
<p>19,6 mm</p> <p>15 mm</p> 		
<p>2103315</p>	<p>A=660mm, B=1560mm</p>	<p>37Q0760: ANGELO PO</p>

GUARNIZIONI PER CELLE / GASKET FOR COUNTERS AND COLD ROOMS

CODICE S&P – PROFILO GUARNIZIONE S&P CODE – GASKET PROFILE	DIMENSIONI ESTERNE MM EXTERNAL DIMENSIONS MM	ADATTABILITA' ADAPTABILITY
<p>34 mm</p> <p>18,5 mm</p> <p>12 mm</p> 		
<p>2103058</p>	<p>A= 1000mm</p>	<p>2103058: SURFRIGO</p>
<p>40 mm</p> <p>20 mm</p> 		

CODICE S&P – PROFILO GUARNIZIONE S&P CODE – GASKET PROFILE	DIMENSIONI ESTERNE MM EXTERNAL DIMENSIONS MM	ADATTABILITA' ADAPTABILITY
2103080	A = 1000mm	2103080: 20x40mm
		
2103215	A= 2000mm	
		
2103070	A=1000mm	2103070: <i>COSTAN</i>
		
2103274	A= 1000mm	
		
2103287	A= 3000mm	
		
2103316	L=1000mm	2103316: <i>MTH</i>
		
2103383	L=1000mm	2103383: <i>MTH</i>

CODICE S&P – PROFILO GUARNIZIONE S&P CODE – GASKET PROFILE	DIMENSIONI ESTERNE MM EXTERNAL DIMENSIONS MM	ADATTABILITA' ADAPTABILITY
<p>23,3mm</p>  <p>20,5mm</p>		
<p>2103406</p>	<p>L=1000mm</p>	<p>2103406:FRIGORBOX</p>
<p>8 mm</p>  <p>19 mm</p>		
<p>2103359</p>	<p>L=1000mm</p>	
<p>8 mm</p>  <p>19 mm</p>		
<p>2103092</p>	<p>L=1000mm</p>	
<p>11 mm</p>  <p>13 mm</p>		
<p>2103370</p>	<p>L=1000mm</p>	<p>2103370:PRIOLINOX</p>
<p>12mm</p>  <p>12mm</p>		
<p>2103694</p>	<p>L=1000mm</p>	<p>2103694:PRIOLINOX</p>
<p>27 mm</p> <p>17 mm</p>  <p>10 mm</p>		
<p>2103686</p>	<p>A=1000mm</p>	<p>*</p>

CODICE S&P – PROFILO GUARNIZIONE S&P CODE – GASKET PROFILE	DIMENSIONI ESTERNE MM EXTERNAL DIMENSIONS MM	ADATTABILITA' / ADAPTABILITY
2103581	A=735mm, B=1875mm	*
2103687	L=1000mm	2103687:FRIGOR BOX

2103172 PROFILO GUARNIZ. VERT. PORTA N25 / VERTICAL DOOR GASKET N25
CM25620413/O:
CASTEL MAC SPA



2103173 PROFILO GUARNIZ. ORIZZ. PORTA N25 / HORIZONTAL DOOR GASKET N25
CM25620417/O:
CASTEL MAC SPA



2103176 GASKET PER FOOT (qtà 1 = 31CM) / GASKET
1300059500:
SCOTSMAN ICE SRL
1300059500R:
SCOTSMAN ICE SRL



BIN GRANDE 6 PIEDI

2108392 TUBO RACCORDO POMPA-FILTRO / HOSE FITTING PUMP-FILTER
13084:
BREMA ICE MAKERS SPA

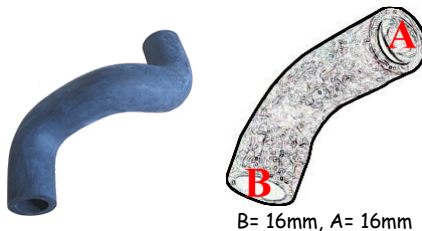

B= 16mm, A= 16mm

2108282 TUBO ASPIRAZIONE E MANDATA POMPA / LOT AND SUCTION SLEEVE
13150:
BREMA ICE MAKERS SPA



B=18mm, A=18mm

2108402 TUBO COLLEGAMENTO RAMPA SPRUZZATORI / HOSE CONNECTION PUMP SPRAY
13054:
BREMA ICE MAKERS SPA
N13054: N.T.F. SRL

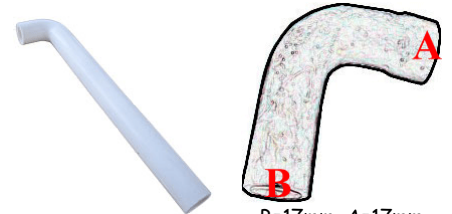

B=17mm, A=17mm

2108393 TUBO MANDATA POMPA 190MM / LOT SLEEVE 190MM
600: I.T.V. S.A.



2108404 MANICOTT O IN GOMMA / LOT SLEEVE
IDRO21: MIGEL S.R.L.

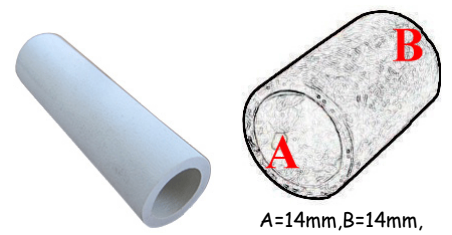

A=14mm, B=14mm, L=70mm

2108229 TUBO
MANDATA POMPA
KL21/31 /
PUMP LOT PIPE
KL21/301
IDR059: **MIGEL S.R.L.**

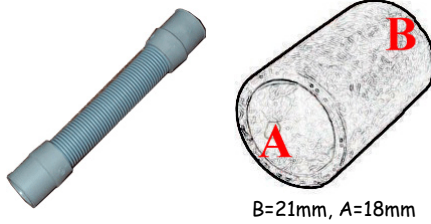

B=21mm, A=18mm

2108228 TUBO
ASPIRAZIONE POMPA
KL21/301 /
PUMP SUCTION PIPE
KL21/301
IDR045: **MIGEL S.R.L.**

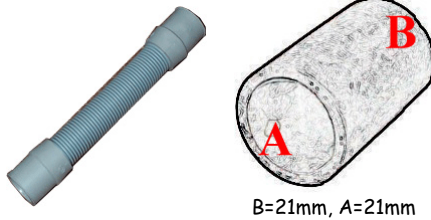

B=21mm, A=21mm

2108227 TUBO
MANDATA POMPA
KL41/301 /
PUMP LOT PIPE
KL41/301
IDR046: **MIGEL S.R.L.**

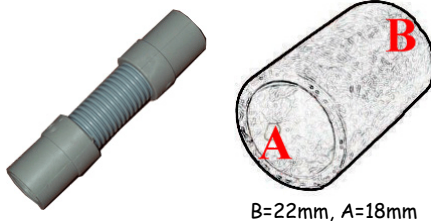

B=22mm, A=18mm

2108020 TUBO SD30
MANDATA POMPA /
LOT PUMP SLEEVE
SD30
Z1ID006EX:
SIMAG SPA
61021500:
SCOTSMAN ICE SRL
Z1ID006EX:
SCOTSMAN ICE SRL

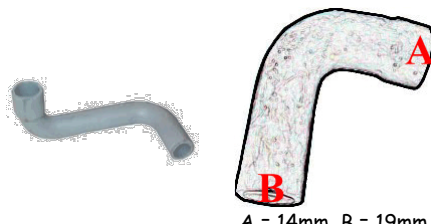

A = 14mm, B = 19mm

2108021 TUBO
SCOTSMAN /
SLEEVE SCOTSMAN
Z1ID007: **SIMAG SPA**
61018901: **SIMAG SPA**
61018901:
SCOTSMAN ICE SRL

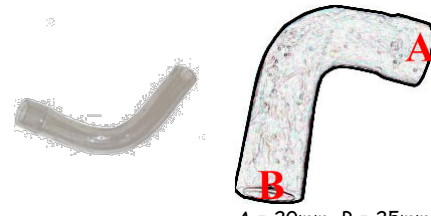

A = 20mm, B = 25mm

2108135 TUBO SD23
MANDATA POMPA /
SLEEVE SD23 LOT
PUMP
Z1ID038:
SCOTSMAN ICE SRL



B=19mm, A=16mm

2108050 TUBO
SCARICO
CONTENITORE /
BIN EXHAUST PIPE
61018900:
SCOTSMAN ICE SRL
Z1ID008: **SIMAG SPA**
Z1ID008EX:
SCOTSMAN ICE SRL

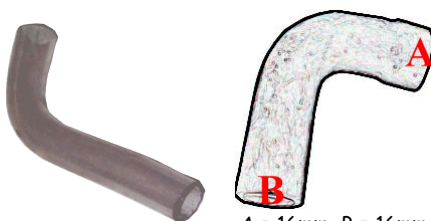

A = 16mm, B = 16mm

2108274 TUBE /
TUBE
Z1ID028:
SCOTSMAN ICE SRL

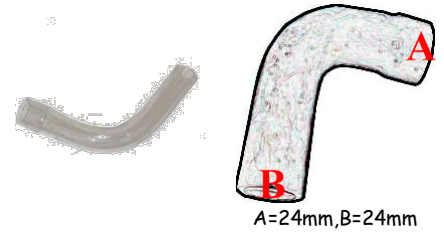

A=24mm, B=24mm

2108134 TUBO SD23
ASPIRAZ. POMPA /
SLEEVE SD23
SUCTION PUMP
Z1ID037:
SCOTSMAN ICE SRL

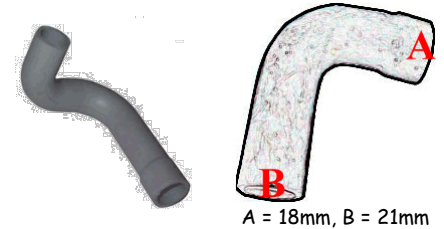

A = 18mm, B = 21mm

2108416 TUBO
ENTRATA ACQUA 1
VIA SL35 /
TUBE WATER INLET 1
WAY SL35
C13126:
BREMA ICE MAKERS SPA



2108043 TUBO
COLLEGAMENTO
FILTRO -RAMPA
SPRUZZATORI /
HOSE CONNECTION
FILTER - RAMP SPRAY
13103:
BREMA ICE MAKERS SPA

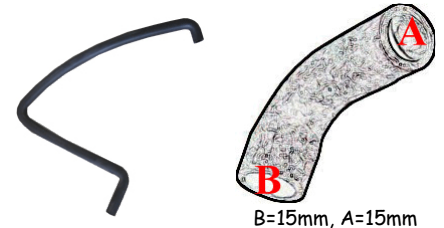

B=15mm, A=15mm

2108156 TUBO
MANDATA E
ASPIRAZIONE POMPA
/
SUCTION/LOT SLEEVE
PUMP
13136:
BREMA ICE MAKERS SPA

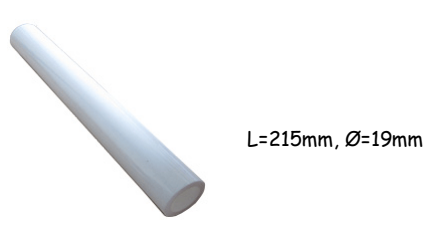

L=215mm, Ø=19mm

2108157 TUBO
MANDATA E
ASP.POMPA /
SUCTION/LOT SLEEVE
PUMP
13137:
BREMA ICE MAKERS SPA



L=293mm, Ø=19mm

2108346 Tubo
collegamento rampa T' /
PUMP SLEEVE
13134:
BREMA ICE MAKERS SPA



2108185 TUBO COLLEGAMENTO FILTRO-RAMPA SPRUZZATORI / HOSE CONNECTION FILTER-SPRAY RAMP
13056:
BREMA ICE MAKERS SPA

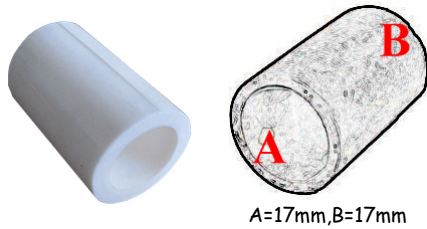

A=17mm,B=17mm

2108186 TUBO COLLEGAMENTO POMPA-FILTRO / HOSE CONNECTION PUMP-FILTER
13055:
BREMA ICE MAKERS SPA

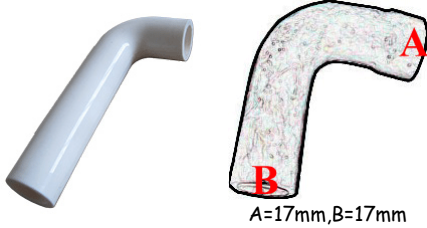

A=17mm,B=17mm

2108162 TUBO ALIMENTAZIONE SPUZZATORI / PRESSURE HOSE
13005:
BREMA ICE MAKERS SPA



A=17mm,B=17mm

2108163 RACCORDO MANDATA ASPIRAZIONE / ELBOW CONNECTOR M23x1,5 ?21mm
10404:
BREMA ICE MAKERS SPA



Ø=23mm

2108314 WATER TUBE ASSY / WATER TUBE ASSY
CM81453567EX:
SCOTSMAN ICE SRL
CM81453698:
SCOTSMAN ICE SRL

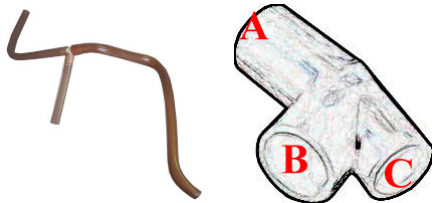

2108315 TUBE / TUBE
CM81453562:
SCOTSMAN ICE SRL
CM81453562/O:
CASTEL MAC SPA

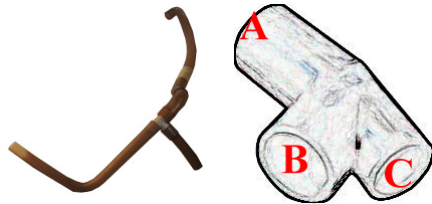

2108363 PLASTCHOS E / PLASTCHOSE
61018500:
SCOTSMAN ICE SRL

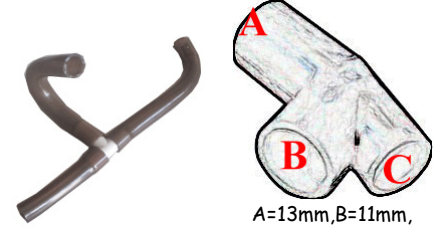

A=13mm,B=11mm,
C=11mm

2108378 WATER HOSE / WATER HOSE
CM25790081:
SCOTSMAN ICE SRL



4122398 TUBE / TUBE
61015002:
SCOTSMAN ICE SRL

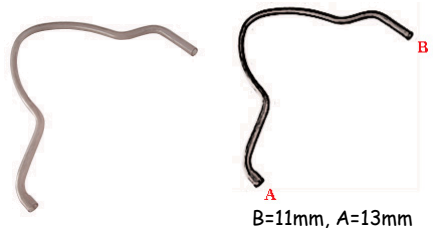

B=11mm, A=13mm

2108322 COLLETTORRE SCARICHI / HOSE CONNECTOR
C10235:
BREMA ICE MAKERS SPA



2108352 TUBO EVAPORATORE KF75 / TUBE EVAPORATOR KF75
2VPO22: MIGEL S.R.L.



TUBI DI CARICO / LOAD PIPES



L
TIPO A - TYPE A

L
TIPO B - TYPE B

L
TIPO C - TYPE C

CODICE S&P S&P CODE	DIMENSIONI DIMENSIONS	TIPO TYPE	CODICE S&P S&P CODE	DIMENSIONI DIMENSIONS	TIPO TYPE
2110030	FC-F 3/4 L=1200mm	A PIANO A FLAT	2110033	FC-F 3/4 L=2000mm	C PIANO / C FLAT ACQUA CALDA / HOT WATER
2110008	FC-F 3/4 L=1500mm	B PIANO B FLAT	2110040	FC-F 3/4 L=2000mm	B PIANO B FLAT
2110169	FC-F 3/4 L=1500mm	C PIANO / C FLAT ACQUA CALDA / HOT WATER	2110041	FC-F 3/4 L=3000mm	B PIANO B FLAT

TUBI DI SCARICO / DRAIN PIPES



L

CODICE S&P S&P CODE	DIMENSIONI DIMENSIONS	CODICE S&P S&P CODE	DIMENSIONI DIMENSIONS
2109001	A=21mm B=19mm L=1500mm	2109063	A=31mm B=19mm L=2000mm
2109002	A=28mm B=24mm L=1500mm	2109023	A=35mm B=28mm L=3000mm
2109012	A=30mm B=24mm L=2000mm	2109003	A=35mm B=32mm L=2000mm
		2109062	A=41mm B=35mm L=2000mm

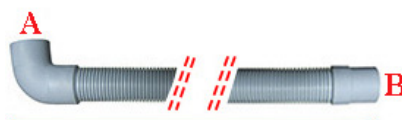

L

CODICE S&P S&P CODE	DIMENSIONI DIMENSIONS	CODICE S&P S&P CODE	DIMENSIONI DIMENSIONS
2109011	A=21mm B=19mm L=1500mm	2109066	A=31mm L=1500mm
2109039	A=21mm L=2000mm	2109052	A=40mm L=1500mm
2109036	A=22mm B=18mm L=2500mm	2109043	A=41mm B=32mm L=1600mm
2109037	A=22mm B=22mm L=1500mm	2109022	A=42mm L=2000mm
2109051	A=28mm B=20mm L=1800mm	2109065	A=47mm L=1500mm
2109004	A=28mm B=24mm L=1500mm	2109045	A=60mm B=45mm L=1500mm
2109059	A=19mm		

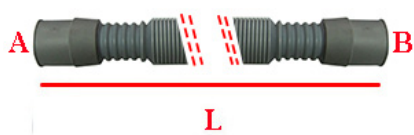

ESTENSIBILE - EXTENSIBILE

CODICE S&P S&P CODE	DIMENSIONI DIMENSIONS
2109009	A=21mm B=19mm L=600-2000mm
2109010	A=39mm B=24mm L=600-2000mm

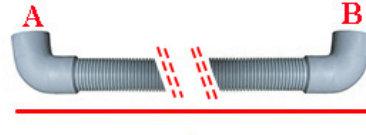

L

CODICE S&P S&P CODE	DIMENSIONI DIMENSIONS
2108317	A=20mm B=20mm L=350mm

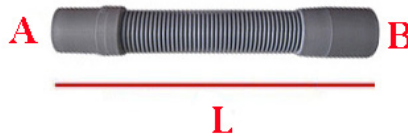

L

CODICE S&P S&P CODE	DIMENSIONI DIMENSIONS	CODICE S&P S&P CODE	DIMENSIONI DIMENSIONS
2109035	A=17mm B=17mm L=130mm	2109053	A=19mm B=19mm L=174mm
2108229	A=18mm B=21mm L=173mm	2109041	A=19mm B=19mm L=280mm
2108227	A=18mm B=22mm L=205mm	2108228	A=21mm B=21mm L=177mm

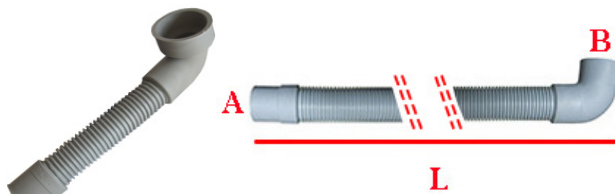

L

CODICE S&P S&P CODE	DIMENSIONI DIMENSIONS
2108333	A=33mm B=52mm L=260mm

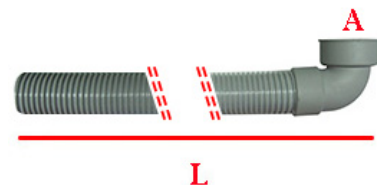

L

CODICE S&P S&P CODE	DIMENSIONI DIMENSIONS
2109030	A=51mm L=2000mm



**SPIRALATO
SPIRALLED**



**VENDITA AL METRO
SELLING AT METER**

CODICE S&P S&P CODE	DIMENSIONI DIMENSIONS	CODICE S&P S&P CODE	DIMENSIONI DIMENSIONS
2110185	Ø=12mm	2109025	Ø=18mm
2110003	Ø=14mm	2110082	Ø=20mm
2109024	Ø=16mm	2110174	Ø=35mm

TUBI / PIPES



PVC

VENDITA AL METRO
SELLING AT METER

CODICE S&P S&P CODE	DIMENSIONI DIMENSIONS	COLORE COLOR	CODICE S&P S&P CODE	DIMENSIONI DIMENSIONS	COLORE COLOR
2110091	Ø=4X6mm	TRASPARENTE TRASPARENT	2110092	Ø=5X7,5mm	TRASPARENTE TRASPARENT
2110170	Ø=4X6mm	ROSSO RED	2110083	Ø=8X12mm	TRASPARENTE TRASPARENT
2110171	Ø=4X6mm	VERDE GREEN	2109067	Ø=13X19mm	TRASPARENTE TRASPARENT
2109026	Ø=4X7mm	TRASPARENTE TRASPARENT	2109055	Ø=18X24mm	VERDE GREEN



GOMMA
RUBBER

VENDITA AL METRO
SELLING AT METER

CODICE S&P S&P CODE	DIMENSIONI DIMENSIONS	COLORE COLOR	CODICE S&P S&P CODE	DIMENSIONI DIMENSIONS	COLORE COLOR
2110085	Ø=5X9mm	NERO BLACK	2109005	Ø=10X17mm	NERO - BLACK FOOD QUALITY
2110137	Ø=5X12mm	NERO BLACK	2110002	Ø=10X17mm	NERO BLACK
2110093	Ø=6X9mm	NERO BLACK	2110139	Ø=25X35mm	NERO BLACK
2110001	Ø=8X17mm	NERO - BLACK FOOD QUALITY			



TEFLON

VENDITA AL METRO
SELLING AT METER

CODICE S&P S&P CODE	DIMENSIONI DIMENSIONS	CODICE S&P S&P CODE	DIMENSIONI DIMENSIONS
2110079	Ø=3X5mm	2108130	Ø=6,3X9,5mm
2110080	Ø=4X6mm		



SILICONE

VENDITA AL METRO
SELLING AT METER

CODICE S&P S&P CODE	DIMENSIONI DIMENSIONS	CODICE S&P S&P CODE	DIMENSIONI DIMENSIONS
2110149	Ø=3X8mm	2110071	Ø=5X8mm
2110151	Ø=4X8mm	2110078	Ø=8X12mm



SANTOPRENE
SANTOPREN

VENDITA AL METRO
SELLING AT METER

CODICE S&P S&P CODE	DIMENSIONI DIMENSIONS	CODICE S&P S&P CODE	DIMENSIONI DIMENSIONS
1123022	Ø=4X7mm	1123027	Ø=6X9mm
2110150	Ø=4,8X8mm	2110148	Ø=6,2X10,5mm

2109056 TUBO
SCARICO /
EXHAUST PIPE

K02611:

ARISTARCO KASTEL
SPA



2109042 TUBO
SCARICO TROPPO
PIENO /
DRAIN PIPE
OVERFLOW

13120:

BREMA ICE MAKERS
SPA



2110161 TUBO
COLLEGAMENTO
SERPENTINA -
RUBINETTO /
COIL-TAP
CONNECTION TUBE

13040:

BREMA ICE MAKERS
SPA



Ø=10X16mm

2110097 ASSIEME
TUBO COLLEG.
RAMPA SPRUZZATORI

/
HOSE SET FOR SPRAY
ARM

C13036:

BREMA ICE MAKERS
SPA



2110184 RH001200-
TUBO CARICO W
BACIN. EC 50/60/130
cm.88 /

RH001200 LOAD PIPE
TANK EC 50/60/130
cm,88

913029:

BRICE ITALIA SRL



2110187 TUBO
RETINATO BIANCO
10/16 /
TUBE WHITE LACED
10/16

1DR005:

MIGEL S.R.L.



2109016 TUBO SD22
ASPIRAZIONE POMPA /
SUCTION PUMP PIPE
SD22

Z1CE015:

SCOTSMAN ICE SRL



2109017 TUBO SD22
MANDATA POMPA /
FORMED HOSE L-
SHAPE SD22

Z1CE016:

SCOTSMAN ICE SRL



2110155 TUBO
SILICONE Ø16/22 /
SILICONE TUBING
?16/22

N13111: N.T.F. SRL

13111:

BREMA ICE MAKERS
SPA



2109058 WATER
DRAIN HOSE ASSY /
WATER DRAIN HOSE
ASSY

CM81454714:

SCOTSMAN ICE SRL

CM814547140:

CASTEL MAC SPA



2109060 DRAIN
TUBE /
DRAIN TUBE

61014819:

SCOTSMAN ICE SRL



2109055 DRAIN
TUBE /
DRAIN TUBE
CS0002801318:
SCOTSMAN ICE SRL



3102007 SPRUZZATO
RE ACQUA ICEBOX /
ICE MAKER WATER
SPRAY
D20002:
BREMA ICE MAKERS
SPA
6802002:
RANCILIO SPA



3102134 526 DP
SPRAY NOZZLE /
526 DP SPRAY NOZZLE
100526: I.T.V. S.A.



3102083 SPRUZZATO
RE /
NOZZLE
1CL078: MIGEL S.R.L.



3102025 SPRUZZATO
RE SIMAG /
SPRAY SIMAG
66055800: SIMAG
SPA
Z1ID026:
SCOTSMAN ICE SRL
66055800:
SCOTSMAN
889124817:
GRUPPO CIMBALI SPA
*: SCOTSMAN ICE
SRL



3102037 GETTO
SCOTSMAN /
JET SCOTSMAN
66015503:
SCOTSMAN ICE SRL
CM19190401/0:
CASTEL MAC SPA
CM19190401:
SCOTSMAN ICE SRL
66015500EX:
SCOTSMAN ICE SRL



3102038

3102038 ROMPI-
GETTO SCOTSMAM /
STOP JET SCOTSMAN
66029600EX:
SCOTSMAN ICE SRL
66029602:
SCOTSMAN ICE SRL
CM196440010:
CASTEL MAC SPA
CM19644001:
SCOTSMAN ICE SRL



= 3102037

3102026 SPRUZZATO
RE SCOTSMAN /
NOZZLE SCOTSMAN
06052900:
SCOTSMAN ICE SRL
66051901ex:
SCOTSMAN ICE SRL
CMCF06052900:
CASTEL MAC SPA



3102028 KIT
SPRUZZATORE
SCOTSMAN 66051903 /
SPRAY SCOTSMAN
66051903
06052901:
SCOTSMAN ICE SRL
66051903ex:
SCOTSMAN ICE SRL



3102102 WATER
INLET FITTING /
WATER INLET FITTING
CMCF78315300:
CASTEL MAC SPA
78315300R:
SCOTSMAN ICE SRL



3105009 PIEDINO
LAVATAZZE M8 /
CUP-WASHERS
SUPPORT M8
904980:
SILANOS SRL

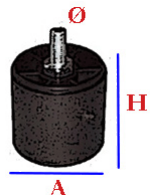

H=13mm, A=39mm,
Ø=8mm

3105054 PIEDINO
LAVASTOVIGLIE M10
hmrnsn /
FOOT DISHWASHER
M10 hmrnsn
984006000:
GRUPPO CIMBALI SPA
9030005:
GRUPPO CIMBALI SPA

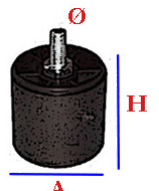

H=15mm, A=33mm,
Ø=10mm

3105001 PIEDINO LT
M10 /
SUPPORT LT M10
69000230:
RANCLIO SPA

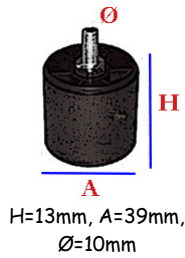

H=13mm, A=39mm,
Ø=10mm

3105017 PIEDINO
REGOLABILE/RIALZAB
ILE UNIVERSALE /
UNIVERSAL
ADJUSTABLE/RAISABL
E SUPPORT
0300030+0300040:
MAGISTER SISTEMA
CAFFE' SRL
900069:
MAGISTER SISTEMA
CAFFE' SRL

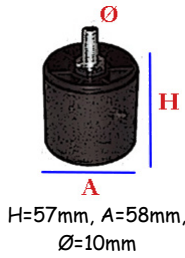

H=57mm, A=58mm,
Ø=10mm

3105023 PIEDINO
BASE ESAGONALE
INOX 55/65
REGOLABILE M10 /
STAINLESS STEEL
SUPPORT 55/65 M10

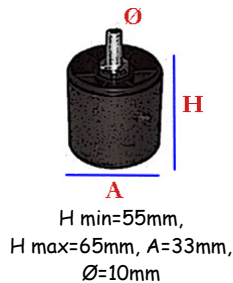

H min=55mm,
H max=65mm, A=33mm,
Ø=10mm

3105061 PIEDE INOX
H100/150 VITE M10X40 /
LEG INOX H100 / 150
SCREW M10x40
M021100020:
COLD LINE S.R.L.



3105043 PIEDINO
INOX 132/178
REGOLABILE M10 /
DEVICE LEG M10
20613:
BREMA ICE MAKERS
SPA
923066:
BRICE ITALIA SRL

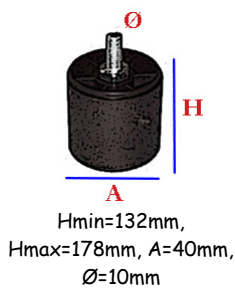

Hmin=132mm,
Hmax=178mm, A=40mm,
Ø=10mm

3105044 PIEDINO
INOX 160/268 M12 /
STAINLESS STEEL
DEVICE LEG 160/268
M12



3105048 PIEDINO
REGOLABILE RESINA /
ADJUSTABLE FOOT
RESIN
K01086:
ARISTARCO KASTEL
SPA
10017:
BREMA ICE MAKERS
SPA

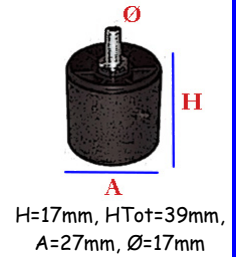

H=17mm, HTot=39mm,
A=27mm, Ø=17mm

3105041 PIEDINO H
100 MM /
ICE MAKER SUPPORT
H 100 MM
10040:
BREMA ICE MAKERS
SPA



H=100mm, A=50mm,
Ø=38mm

3105047 PIEDINO /
SUPPORT
66063800:
SCOTSMAN ICE SRL
CMNM66063800:
CASTEL MAC SPA



Øb=58mm, H=143mm,
Øa=51mm





3105049 KIT PIEDINI
(4 PEZZI) /
EQUIPMENT FEET KIT
(4 PEACES)
65067000:
SCOTSMAN ICE SRL





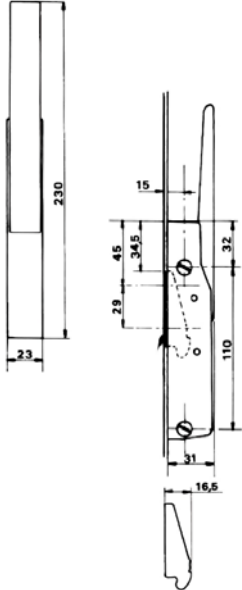

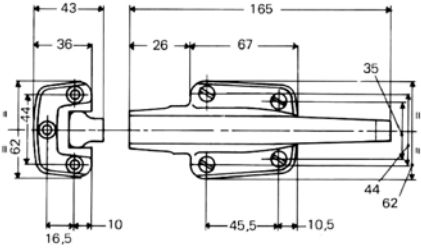

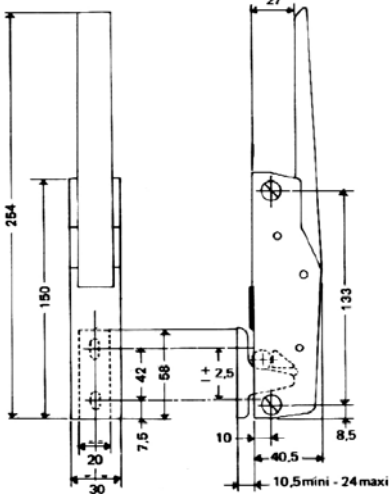

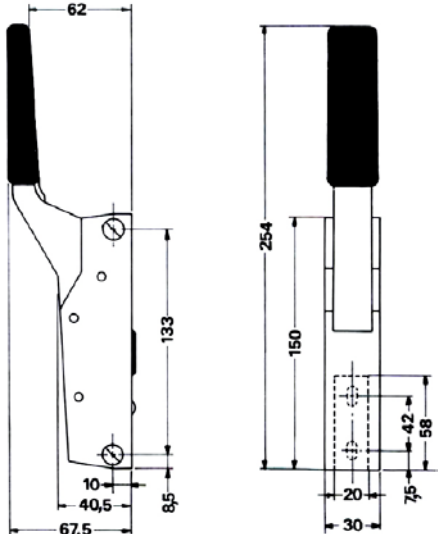

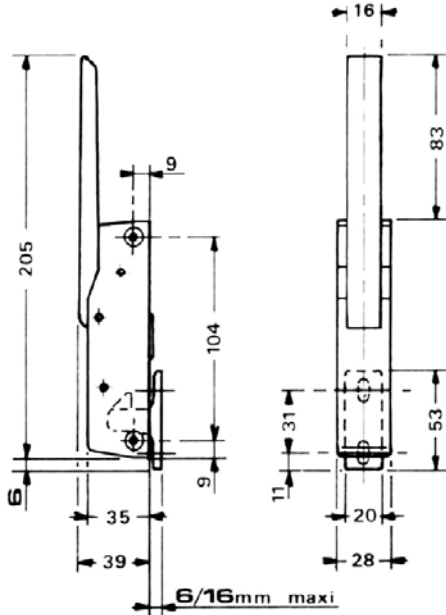
3105058 KIT PIEDINI
MODELLO KLP7 /
KIT FEET MODEL
KLP7
KLP7:
SCOTSMAN ICE SRL

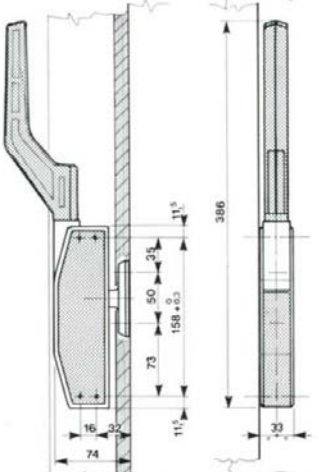



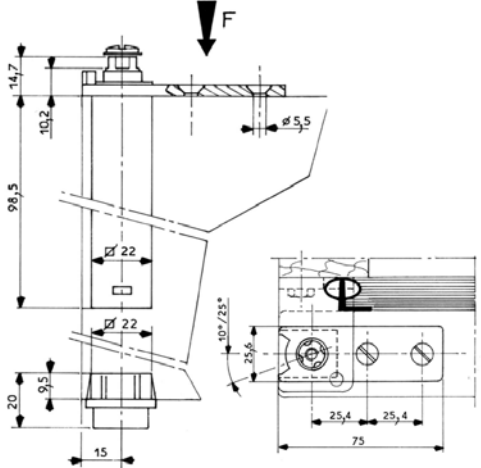

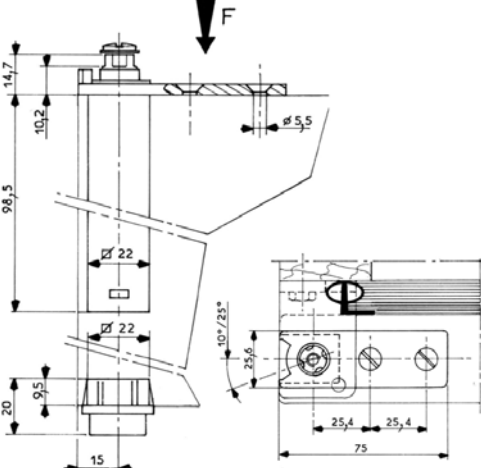

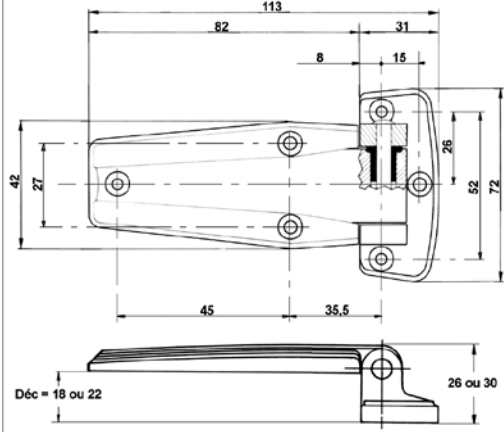
CERNIERE E CHIUSURE PORTA / AUTOMATIC LATCHES AND HINGES

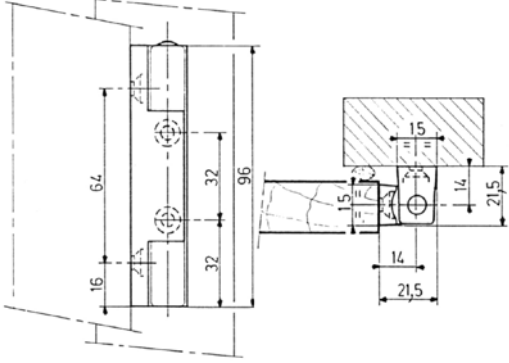
Codice Code		Misure Measures
3125067		
3125068		
3125069		

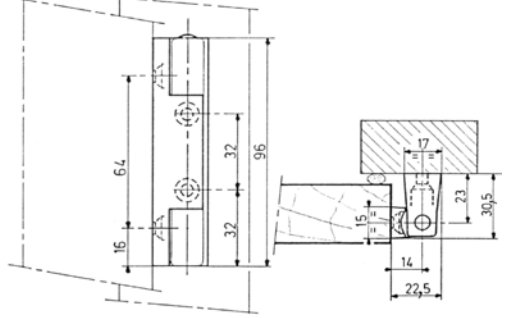
Codice Code		Misure Measures
3125070		
3125071		
3108338		

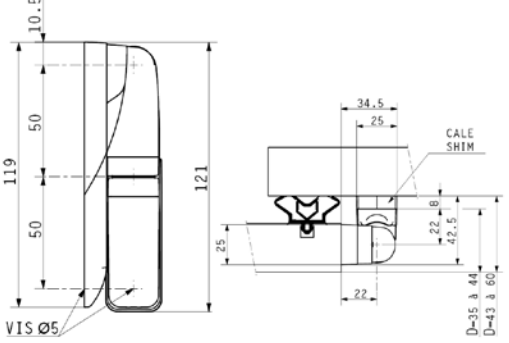
Codice Code		Misure Measures
8111037		
8111073		
8111074		

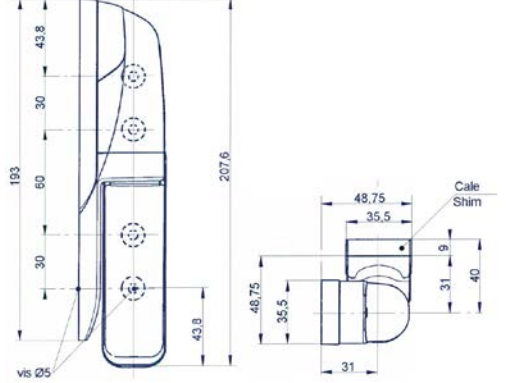
Codice Code		Misure Measures
8111075		
8111076		
8111077		
8111078		

3108474 DOOR

HANDLE /
DOOR HANDLE

T00202:

SCOTSMAN ICE SRL



3108476 MANOPOL

A SPINGICARR. AD
"U" int. fori 115 /
"U" SHAPED HANDLE
INT. 115



Interasse=115mm

3108257 MANIGLIA

FRIGO NERA AD
INCASTRO
FIOCCHETTI 74311008
/
HANDLE FOR
REFRIGERATOR



3108573 MANOPOL

A M10 art.70017 /
KNOB M10

10374:

BREMA ICE MAKERS
SPA



TAP=3108574

3108496 MANIGLIA

NERA UGOLINI /
BLACK HANDLE
UGOLINI

2280027460006:

UGOLINI SPA



3108404 LEVA

RUBINETTO NERA /
BLACK TAP HANDLE

2270001801:

UGOLINI SPA



3108388 CHIUSURA

1 PUNTO PER PORTA
TAMPONE SERIE 3025
/ CLOSING DOOR



3108338 MANIGLIA

CELLA DX-SX 1825
L386mm C/AGGANCIO
1089 /
HANDLE LEFT/RIGHT
1825 L386mm



3108405 MANIGLIA

ESTERNA GRIGIA
MTH 200X110X50H
CON SERRATURA /
EXTERNAL HANDLE
MTH 200X110X50H
WITH LOCK



3108497 MANIGLIA

EST. SENZA SERR.
GRIGIA
COD.MTH13019 /
OUTSIDE HANDLE
GREY WITHOUT
LOCK COD.MTH13019



3108342 MANIGLIA

INTERNA MTH /
HANDLE MTH



3108343

3108343 KIT

FISSAGGIO
MANIGLIA MTH /
HANDLE FIXING SET
MTH

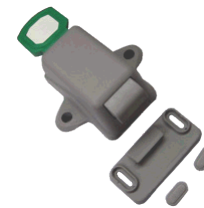

3108342

3108457 MANIGLIA

INTERNA 2700 X
CH.1825/2025/3025 /
INTERNAL HANDLE
2700 FOR
CH1825/2025/3025



3108567 MANIGLIA

INTERNA CON
RISCONTRO 2132 /
INSIDE HANDLE
WITH STRIKER 2132



8111030 CERNIERA

OMNIATECNICA
PERNO QUADRO /
HINGE
OMNIATECNICA
22329:

EVERLASTING SRL

M121100020:

COLD LINE S.R.L.

5038447:

COLD LINE S.R.L.

MA2476700:

MARENO INDUSTRIE



PERNO
QUADRO=7,5X7,5mm

ALI SPA
083876:
ELECTROLUX
PROFESSIONAL
S.P.A.
BN1412050:
MARENO INDUSTRIE
ALI SPA

8111073 CERNIERA
PORTA PERNO
QUADRO 8MM
ANGELO PO /
DOOR HINGE A.PO
RC0089:
FORCAR S.R.L.



8111037 CERNIERA
POLARIS-ICEMATIC
TESTA A CROCE /
DOOR HINGE
POLARIS-ICEMATIC



8111120 "CERNIERA"
"FAJOTA""DB.821 -
PERNO QUADRO -
FILETTO M4X9" /
HINGE "FAJOTA"
DB.821 M4X9
CM25702856/0:
CASTEL MAC SPA
CM25702856:
SCOTSMAN ICE SRL



PERNO QUADRO=
6X6mm

8111052 DOOR
HINGE /
DOOR HINGE
CM19120045/0:
CASTEL MAC SPA
CM19120045:
SCOTSMAN ICE SRL



8111053 CERNIERA
D201 /
HINGE D201
CM25130137:
SCOTSMAN ICE SRL
CM25130137/0:
CASTEL MAC SPA



8111010 CERNIERA
SPORT VEGA 20 /
HINGE SPORT VEGA 20
2781212:
COSMETAL SRL

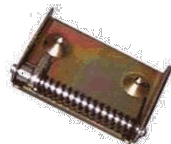

8111012 COPPIA
CERNIERE COSMETAL
40/100KG /
COUPLE HINGE
COSMETAL 40/100KG
2781213:
COSMETAL SRL

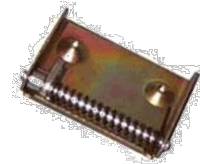

8111005 CERNIERA
PROF.OT SMER.NI
ART.3 /
HINGE PROF.OT
SMER.NI ART.3
CM19120050:
SCOTSMAN ICE SRL
CM19120050/0:
CASTEL MAC SPA



8111102 ASSIEME
CERNIERA PORTA SX
AP/AE - FINITO /
ASSEMBLY HINGE
DOOR SX AP / AE -
FINISHED
11499:
ARISTARCO KASTEL
SPA



8111103 ASSIEME
CERNIERA PORTA DX
AP/AE - FINITO /
ASSEMBLY HINGE
DOOR DX AP / AE -
FINISHED
11498:
ARISTARCO KASTEL
SPA



8111049 CERN.P.A.G5
07BM4 43003300 / HING
G507BM4 43003300
RTBF900013:
MBM- EUROTEC SRL -
DIV. COOKING
SERVICE



8111087 CERNIERA
MONDIAL A MOLLA /
SPRING HINGE
MONDIAL
5622108:
MONDIAL GROUP
S.R.L.



8111066 CERNIERA
CMV 1246 MONDIAL
ELITE 4,6 CM /
HINGE CMV 1246
MONDIAL ELITE 4,6
CM



8111095 HINGE /
HINGE

CM81401522:
SCOTSMAN ICE SRL
CM81401522/O:
CASTEL MAC SPA



8111110 1 701 LEFT
DOOR GUIDE Q20-30 /
1 701 LEFT DOOR
GUIDE Q20-30

606026:
ARISTARCO KASTEL
SPA
1701: I.T.V. S.A.
201701: I.T.V. S.A.



8111111 1 700 RIGHT
DOOR GUIDE Q20-30 /
1 700 RIGHT DOOR
GUIDE Q20-30

606027:
ARISTARCO KASTEL
SPA
1700: I.T.V. S.A.
201700: I.T.V. S.A.



3125024 CONTRONA
SELLO INTER. 375MM
D. 400X22
EVERLASTING /
WHOLE PAWL 375MM
D. 400X22
EVERLASTING



3125041 SCROCCO
RONDA TIPO NUOVO
PER SPORTELLI BAR
RONDA /
DOOR WHOLE PALW
FOR BAR RONDA



3125086 SCROCCO
TIPO VECCHIO NERO
(Ronda) /
SPRING LATCH TYPE
OLD BLACK



3125039 SCROCCHET
TO PORTA PRIOLINOX
S3000 /
DOOR WHOLE PAWL
PRIOLINOX S3000



3125079 BLOCCO
SUPPLEMENTARE
ART.1875 /
ADDITIONAL BLOCK
ART.1875



3125080 CHIUSURA
PORTA FORNO
INTERASSE 134 MM L
172 MM /
OVEN HANDLE LACHT
134MM L. 172MM
C8118-00:
INOXTREND S.R.L.



3125069 CHIUSURA
AUTOMATICA
S/SERRATURA
INTERASSE 133 MM
254X33MM /
AUTOMATIC DOOR
LOCK 133MM
254X33MM



3125070 CHIUSURA
AUTOM.
S/SERRATURA
254X30MM
IMPUGNATURA
CURVA /
AUTOMATIC DOOR
LOCK 254X30MM
2872000:
MARENO INDUSTRIE
RTFOC00403: MBM



3125071 CHIUSURA
AUTOMATICA
S/SERRATURA
INTERASSE 104MM
205X28MM /
AUTOMATIC DOOR
LOCK 104MM
205X28MM



3125053 CHIUSURA
PORTA CROMATA
248X28MM /
DOOR LOCK
248X28MM



3125067 CHIUSURA
AUTOMATICA PER
ARMADI INTERASSE
110MM 230X23MM /
AUTOMATIC DOOR
LOCK 110MM
230X23MM



3125059 CHIUSURA
DX-SX SENZA
SERRATURA /
DOOR LOCK
LEFT/RIGHT



3125068 CHIUSURA
AUTOMATICA CON
GANCIO REGOLABILE
/
AUTOMATIC DOOR
LOCK



3125082 CHIUSURA/
CHIAVE VERN
SP.P.80/90 5270/C-2V /
LOCKAGE SP.P.80/90
5270/C-2V

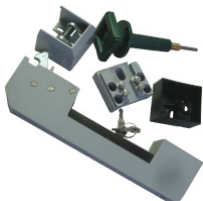

3125040 CHIUSURA
FRIGO FRIULINOX /
DOOR WHOLE PAWL
FRIULINOX



3125084 SERRATUR
A GIUSSANI
CATENAC.43 TTG-> /
GIUSSANI LOCK BOLT
.43 TTG->
5601107:
MONDIAL GROUP
S.R.L.



3125074 KIT
CHIUSURA PORTA
CON CHIAVE /
DOOR CLOSER SET
WITH KEY



3125075 SPESSORI
PER CHIUSURA PORTA
SPESSORE 60-80MM /
THICKNESS FOR DOOR
CLOSER 60-80MM



3125057 MECCANIS
MO CHIUSURA SX
0751.020941 /
DOOR LOCK SX
0751.020941
5900123: GIORIK SPA



3125085 MECCANIS
MO CHIUSURA PORTA
FORNO /
OVEN DOOR LOCKING
MECHANISM



3125092 MECCANIS
MO PORTA
ESTREMITA' /
OVEN HANDLE
TOP/BOT.TIE ROD 146
mm



3125066 KIT
CHIUSURA PORTA
FORNO COVEN
COMPLETO /
DOOR LOCK



3125042 AS.SERRAT
URA P.F.FEC100 /
CATCH COMPLETE
FEC100
6AF0C00051:
MBM- EUROTEC SRL -
DIV. COOKING
SERVICE



3125060 AGGANCIO
PER CHIUSURA /
DOOR LOCK
COUPLING
809875:
EMMEPI GRANDI
CUCINE S.R.L.
8C0315:
EMMEPI GRANDI
CUCINE S.R.L.
1500: FOINOX S.P.A.



3125022 CRICCHETT
O COMPLETO PORTA
'96 GS /
WHOLE PAWL '96' GS
3030100:
ANGELO PO GRANDI
CUCINE SPA
DW150402:
DIHR-ALI SPA



3125050 SICUREZZA
PORTA BIANCA COMP
ASS. (C. ANT+POST) /
ACTUATOR FOR DOOR
TOUCH SENSITIVE
SWITCH COMPLETE
CEMP18EX:
OMNIWASH SRL -
SOCIETA' A SOCIO
UNICO



3125093 CHIUSURE
MAGNETICHE RPV30
ZEN. /
MAGNETIC CLOSURES
RPV30 ZEN
EN14500:
OEM ALI SPA



Ø=M6, D. 32

3124179 PILETTA X
TROPPOPIENO ABS
NSF /
DRAIN FITTING FOR
OVERFLOW ABS NSF
K00006:
ARISTARCO KASTEL
SPA



4114374 RACCORDO
SCARICO TROPPO
PIENO /
FITTING DRAIN
OVERFLOW
10241:
BREMA ICE MAKERS
SPA



3124207 RH003285-
PILETTA DRITTA
DIAM. 20 /
RH003285-WASTE
STRAIGHT DIAM. 20
910067:
BRICE ITALIA SRL



3124239 RACCORDO
SCARICO
.EQUALIZZ.CF660533-
00 /
FITTING DISCHARGE
CM19612515/0:
CASTEL MAC SPA
66053300:
SCOTSMAN ICE SRL



NUT =3124240

3124243 RACCORDO
EQUALIZZATORE /
EQUALISER FITTING
CM196125150:
CASTEL MAC SPA



3124250 SCARICO
BANCO DEPOSITO
GHIACCIO E21...35 (C /
DRAIN FITTING FOR
REFRIGERATED
BENCH
CM256853180:
CASTEL MAC SPA



3124120 DRAIN
FITTING /
DRAIN FITTING
Z1AC057:
SCOTSMAN ICE SRL



4114390 RACCORDO
MANDATA POMPA KL-
KD3 /
PUMP CONNECTION
KL-KD3
2CL006: MIGEL S.R.L.



4114391 RACCORDO
SCARICO
CONTENITORE KL-KD3
/
CONTAINER DRAIN
CONNECTION KL-KD3
2CL007: MIGEL S.R.L.



3124175 RACCORDO
ASPIRAZIONE POMPA
KL - KD /
SUCTION JOINT FOR
PUMP KL-KD
2CL005: MIGEL S.R.L.



3124184 DRAIN
FITTING /
DRAIN FITTING
CM25690807:
SCOTSMAN ICE SRL
CM25690807/0:
CASTEL MAC SPA



4114362 WATER
PUMP FITTING /
WATER PUMP FITTING
Z1AC030
SCOTSMAN DIV.
FRIMONT SPA



4114659 WATER
PUMP FITTING /
WATER PUMP FITTING
Z1AC029:
SCOTSMAN DIV.
FRIMONT SPA



3124061 RACCORDO
SCARICO
CONTENITORE /
BIN DRAIN JUNCTION
Z1AC028:
SCOTSMAN ICE SRL



3124183 SCARICO
BIN L=45 MM /
DRAIN BIN L=45 MM
66021902:
SCOTSMAN ICE SRL



3124070 SCARICO
BIN SCOTSMAN /
BIN DRAIN PLUG
66021901: SIMAG
SPA
889125096:
GRUPPO CIMBALI SPA
66021901:
SCOTSMAN ICE SRL



3124211 RH00B267-
GHIERA PER PILETTE
CON CROCE /
RH00B267-NUT FOR
DRAIN WITH CROSS
910058:
BRICE ITALIA SRL
RH00B267:
EURFRIGOR SRL



3124123 GHIERA
NERA PER PIEDE /
BLACK RING FOR
FOOT
1CD070: MIGEL S.R.L.



3124240 GHIERA M24
X 1.5 GG /
NUT M24 X 1.5 GG
CM19305022/0:
CASTEL MAC SPA



3124204 CURVA
SCARICO /
DRAIN ELBOW
9121206:
GRUPPO CIMBALI SPA



3124032 CURVA CON
GHIERA X SCARICO /
CURVE WITH RING
FOR DRAIN JUNCTION
Z1AD011: SIMAG SPA
Z1AD011:
SCOTSMAN ICE SRL



3124208 RACCORDO
DI SCARICO
RAFFREDDAMENTO
AD ARIA /
FITTING DRAIN AIR
COOLING
K01805:
ARISTARCO KASTEL
SPA



3124195 RACCORDO
DI SCARICO RAFF. AD
ACQUA /
FITTING DRAIN
WATER COOLING
K01806:
ARISTARCO KASTEL
SPA



3124162 RACCORDO
DI SCARICO /
DRAIN FITTING
10431:
BREMA ICE MAKERS
SPA



4114781 COLLETTOR
E SCARICHI /
DRAIN FITTING
10579:
BREMA ICE MAKERS
SPA
C10052:
BREMA ICE MAKERS
SPA



4122012 RH00C196-
COLLETT. SCARIC. ACQ
UA P.G. ACQUA* /
RH00C196 WATER
DRAIN COLLECTOR
910023:
BRICE ITALIA SRL



3124251 363 THREE
WAY WATER
DISTRIBUTOR /
363 THREE WAY
WATER DISTRIBUTOR
300363: I.T.V. S.A.



3124161 SCARICO
ACQUA /
WATER DRAIN
FITTING
1DR031: MIGEL S.R.L.



3124069 SCARICO
ACQUA SD23 /
WATER DRAIN SD23
Z1ID025:
SCOTSMAN ICE SRL
Z1ID025: SIMAG SPA



3124196 FITTING /
FITTING
66099300:
SCOTSMAN ICE SRL



3124202 FITTING
DRAIN /
FITTING DRAIN
IOM909114001:
SCOTSMAN ICE SRL



4114175 COLLETTOR
I SCARICHI BRM /
COLLECTOR 3-WAYS
WITH HOSE 1 WAY
CLOSED
C26452:
BREMA ICE MAKERS
SPA



4114161 ASSIEME
COLLETTORE
SCARICHI VERSIONE
ARIA /
ASSEMBLY
COLLECTOR DRAIN
VERSION AIR
C10006:
BREMA ICE MAKERS
SPA



3111206 ASSIEME
TROPOPIENO CON
TAPPO ED OR /
ASSEMBLY
OVERFLOW WITH
PLUG AND OR
K01317:
ARISTARCO KASTEL
SPA

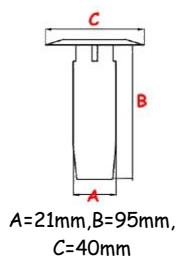

3111040 ASSIEME
TUBO TROPOPIENO /
OVERFLOW PIPE
C10133:
BREMA ICE MAKERS
SPA

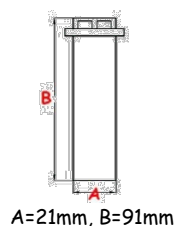

3111092 TUBO
TROPOPIENO CB184 /
OVERFLOW CB184
13028:
BREMA ICE MAKERS
SPA

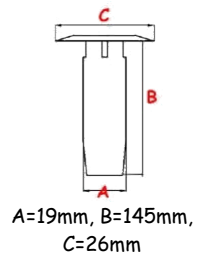

3111131 TUBO
TROPO PIENO /
OVERFLOW PIPE
10133:
BREMA ICE MAKERS
SPA

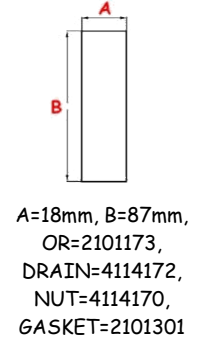

3111128 TUBO
TROPO PIENO /
OVERFLOW
10399:
BREMA ICE MAKERS
SPA

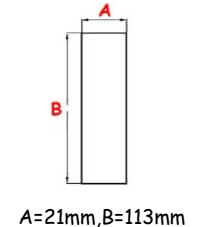

3111154 RACCORDO
SCARICO
TROPOPIENO KL-KD3
/
OVER FLOW DRAIN
CONNECTION KL-KD3
2CL008: MIGEL S.R.L.

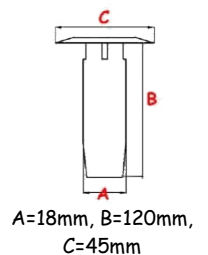

3111216 OVERFLOW
TUBE /
OVERFLOW TUBE
66060100:
SCOTSMAN ICE SRL

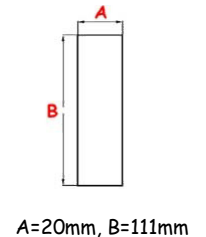

3111190 TAPPO
TROPO PIENO /
OVERFLOW TUBE
66069802:
SCOTSMAN ICE SRL

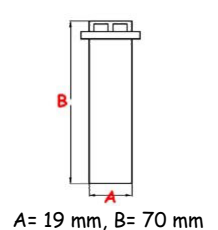

3111037 TROPPOPIE
NO SIMAG /
OVERFLOW SIMAG
66038705:
SCOTSMAN ICE SRL

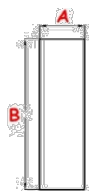

A = 25 mm, B = 105 mm

3111167 OVERFLOW
TUBE /
OVERFLOW TUBE
66069800:
SCOTSMAN ICE SRL



3111123 OVERLOAD
/
OVERLOAD
1800871150:
SCOTSMAN ICE SRL



3109190 VENTOLA §
254 34φ /
FAN § 254 34φ
32M2260:
ANGELO PO GRANDI
CUCINE SPA



3109210 Ventola
aspirante /
suction fan
20153:
BREMA ICE MAKERS
SPA



3109041 VENTOLA
MOPLEN D. 154X28° 4-
VEA-012/IMB /
MOPLEN FAN D.
154X28° 4-VEA-012/IMB
085287:
ELECTROLUX
PROFESSIONAL
S.P.A.
10213:
BREMA ICE MAKERS
SPA



3109072 VENTOLA
ASPIRANTE D.300X28° /
FAN D300X28°
62041936:
SCOTSMAN ICE SRL
20407:
BREMA ICE MAKERS
SPA



3109126 FAN BLADE
/
FAN BLADE
62041934:
SCOTSMAN ICE SRL



3109168 BLADE FAN
ICE 250/400/406 /
BLADE FAN ICE
250/400/406
IOM913133202:
SCOTSMAN ICE SRL



3109203 BLADE /
BLADE
62041932:
SCOTSMAN ICE SRL



4114748 FAN BLADE
/
FAN BLADE
IOM913133301:
SCOTSMAN ICE SRL



4122352 VENTILATO
RE HIDRIA 0309-4-
1072230-240/1/50-60 /
FAN MOTOR HIDRIA
0309-4-1072230-240 / 1 /
50-60
CM18562559/2:
CASTEL MAC SPA



3109042 GIRANTE
POMPA D. 42 /
IMPELLER PUMP D. 42
10066:
BREMA ICE MAKERS
SPA

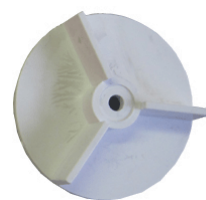

3109213 BLADE /
BLADE
CMCF65034000:
CASTEL MAC SPA
65034000:
SCOTSMAN ICE SRL



4114031 ASS.
BACINELLA N20 /
BASIN SET N20
CM81403005/0:
CASTEL MAC SPA
CM81403005:
SCOTSMAN ICE SRL
81403005/0:
ICEMATIC

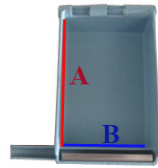
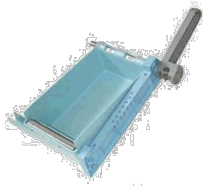

A=200mm, B=121mm

4114117 ASS.
BACINELLA N25 /
COMPLETE TILTING
PAN N25
81401621/0:
ICEMATIC
MONTBLANC20:
CIMBALI
CM81401621:
SCOTSMAN ICE SRL
CM81401621/0:
CASTEL MAC SPA

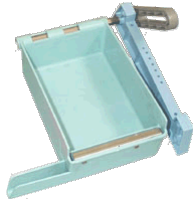

A=200mm, B=127mm

4114002 ASSIEME
BACINELLA N30 -
N35S ICEMATIC /
BASIN SET N30
ICEMATIC
N30, N35:
ICEMATIC
CM81403007:
SCOTSMAN ICE SRL
CM81403007/0:
CASTEL MAC SPA



A=200mm, B=160mm

4122268 ASSIEME
BACINELLA
EVAPORATORE .E35 /
ASSEMBLY BASIN
EVAPORATOR .E35
CM814000640:
CASTEL MAC SPA



B=160mm, A=182mm

4114258 ASS.BACIN
ELLA+LEVA N45L /
BASIN WITH LEVER
N45L
CM81414467/0:
CASTEL MAC SPA
81414467/0:
ICEMATIC

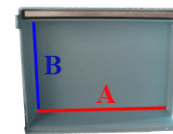
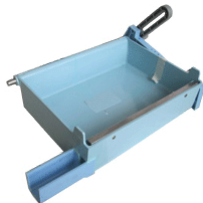

A=270mm, B=200mm

4114629 BACINELL
A N40-N55 SENZA
LEVA /
BASIN N40-N55
WITHOUT LEVER
81413006/0:
ICEMATIC
CM81413006:
SCOTSMAN ICE SRL
CM81413006/0:
CASTEL MAC SPA

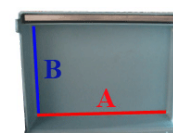
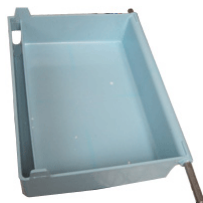

A=270mm, B=200mm

4114013 ASSIEME
BACINELLA+LEVA
RIB. N55-N40 /
BASIN SET +
UPSETTING LEVER
N55
81413001/0:
ICEMATIC
CM81413001/0:
CASTEL MAC SPA
CM81413001:
SCOTSMAN ICE SRL

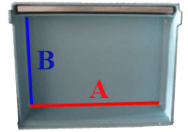
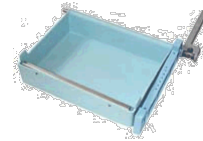

A=270mm, B=200mm

4114091 ASSIEME
BACINELLA+LEVA
RIBALT.N55L-N65 /
BASIN+OVERTURN
LEVER SET N55L
81414519/0:
ICEMATIC
81423003/0:
ICEMATIC
CM81414519/0:
CASTEL MAC SPA
CM81423003:
SCOTSMAN ICE SRL

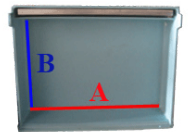
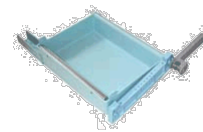

A=270mm, B=200mm

4122154 ASSIEME
BACINELLA
EVAPORATORE
+LEVA E55 /
ASSEMBLY BASIN
EVAPORATOR E55 +
LEVER
CM81400034/0:
CASTEL MAC SPA

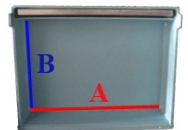

B=182mm, A=269mm

4122462 ASSIEME
BACINELLA+LEVA
N90L /
BASIN SET+
UPSETTING LEVER
N90L
N90L:
CASTEL MAC SPA

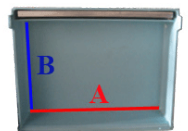

A= 445mm, B=180mm

4114007 ASSIEME
BACINELLA+LEVA
RIB.N75-N90 /
BASIN SET+
UPSETTING LEVER
N75
81423002/0:
ICEMATIC
CM81423002/0:
CASTEL MAC SPA

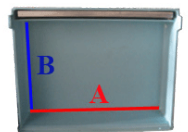
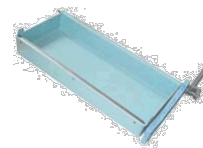

A=448mm, B=200mm

4122021 ASS.BACIN.
EVAP.+LEVA E75 /
ASSEMBLY BASIN E75
+ LEVER
CM81400154/0:
CASTEL MAC SPA

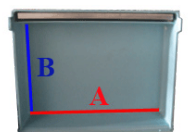

A=448mm, B=200mm

4114032 ASS,
BACINELLA N12-22 /
BASIN SET N12-22
81442008/0:
ICEMATIC
CM81442008:
SCOTSMAN ICE SRL
CM81442008/0:
CASTEL MAC SPA

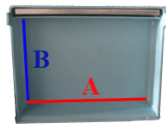

A=680mm, B=205mm

4114076 BACINELL
A VEGA20/30 KG /
BASIN VEGA 20/30 KG
2781337:
VEGA
CM81300008/0:
CASTEL MAC SPA

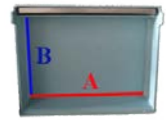
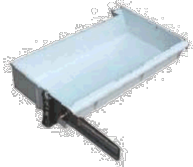

A=200mm, B=130mm

4114037 VASCHETT
A EVAPORATORE
VEGA 40 /
EVAPORATOR TANK
VEGA 40
CM81300045/0ex:
CASTEL MAC SPA
2781338:
COSMETAL SRL
CM813000460:
CASTEL MAC SPA

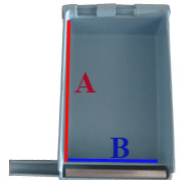

A=280mm, B=165mm

4114077 BACINELL
A VEGA 60 /
BASIN VEGA 60
2781339:
VEGA DIV. DELLA
CASTEL MAC SPA
2781339:
COSMETAL SRL
CM81300066/0:
CASTEL MAC SPA
CM81300067/0:
CASTEL MAC SPA

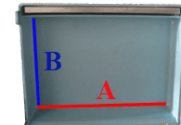

A=360mm, B=165mm

4114419 BACINELL
A CON PERNO /
BASIN SET
C22356:
BREMA ICE MAKERS
SPA

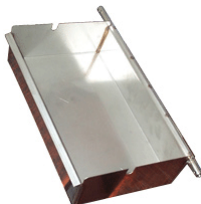

A=288mm, B=185mm

4114422 BACINELL
A CON PERNO
COMPLETA /
WATER BASIN WITH
PIN ASSY
IMF58:
BREMA ICE MAKERS
NC10491: N.T.F. SRL

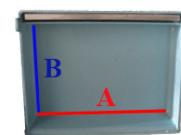

A=305mm, B=182mm

4114827 BACINELL
A CON PERNO IMF28 /
TRAY WITH PIN IMF
28
IMF28:
BREMA ICE MAKERS
SPA

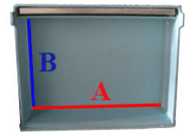
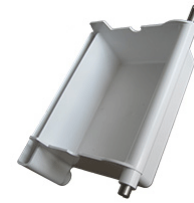

B= 130mm, A= 185mm

4114653 BACINELL
A CON PERNO /
SUMP FOR ICE-CUBE
MAKER
IMF28:
BREMA ICE MAKERS
SPA

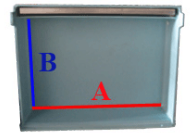

B=150mm, A=195mm

4114426 BACINELL
A CON PERNO
300X130mm /
TRAY WITH PIN
300X130mm
C10489:
BREMA ICE MAKERS
SPA

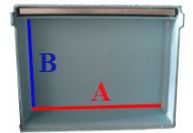

A=300mm, B=130mm

4114544 BACINELL
A CON PERNO /
COLLECTING TRAY
503x150x75mm
C22462:
BREMA ICE MAKERS
SPA

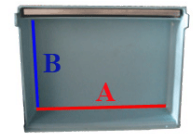
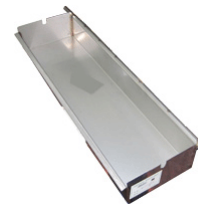

A=503mm, B=75mm

4114720 BACINELL
A CON PERNO
COMPLETA /
BASIN COMPLETE
RC10493:
BREMA ICE MAKERS
SPA

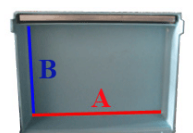
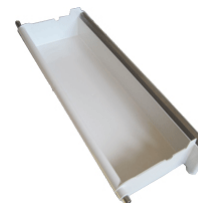

A=515mm, B=63mm

4122437 5360
VASCHETTA DI
RIBALTAMENTO Q20-
30 /
5360 WATER PAN
WITH MECH. Q20-30
105360: I.T.V. S.A.

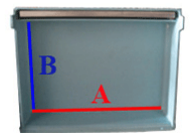

A=230mm, B=120mm

4122366 5361
VASCHETTA ACQUA
CON MECCANISMO DI
RIBALTAMENTO Q40 -
-232X167mm /
5361 WATER PAN
WITH MECH. Q40
105361: I.T.V. S.A.

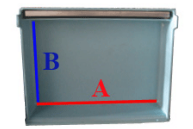

A=232mm, B=167mm

4122015 CUBA
 AGUA CON
 MECANISMOS ITV90
 430X165 /
 WATER TRAY WITH
 LEVERAGE ITV90
 430X165
 105205: I.T.V. S.A.

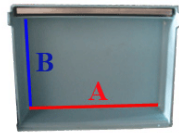
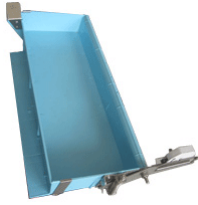

A=430mm, B=165mm

4114766 BACINELL
 A ACQUA EC20
 COMPACT /
 WATER TRAY FOR
 EC20 COMPACT
 910003:
 BRICE ITALIA SRL
 RH00A004:
 EURFRIGOR ICE
 MAKERS SRL

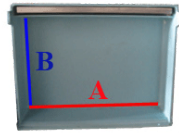

A=180mm, B=140mm

4114156 BACINELL
 A EC20/30 NEW /
 TANK EC20/30 NEW
 RH00A005:
 EURFRIGOR SRL
 910004:
 BRICE ITALIA SRL
 RH00A005:
 EURFRIGOR ICE
 MAKERS SRL

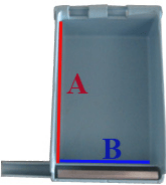

A=180mm, B=180mm

4114100 BACINELL
 A EC 50 EURFRIGOR /
 BASIN EC 50
 EURFRIGOR
 RH00A006:
 EURFRIGOR SRL
 910005:
 BRICE ITALIA SRL
 EC40-EC-50:
 EURFRIGOR ICE
 MAKERS SRL

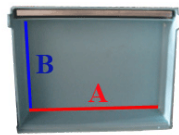

B= 180mm, A= 245mm

4122274 RM00A047-
 BACINELLA ACQUA N
 EC 130 /
 RM00A047-BASIN
 WATER N EC 130
 922002:
 BRICE ITALIA SRL

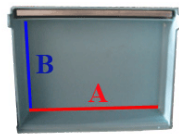

B=170mm, A=680mm

4122119 VASCHETT
 A /
 PAN
 K00045:
 ARISTARCO SPA

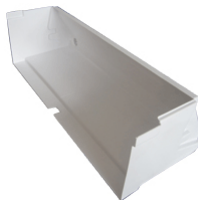

4114967 VASCHETT
 A RACCOLTA ACQUA
 RB400 /
 BASIN WATER RB400
 *: CASTEL MAC SPA
 CM25820116:
 SCOTSMAN ICE SRL



DIMENSIONS
 185X450mm

4114145 ASSIEME
 VASCHETTA
 PARASPRUZZI MV18 /
 ASSEMBLY BASIN
 SPLASH GUARD MV18
 CM25820126/O:
 CASTEL MAC SPA
 CM81453130/O:
 CASTEL MAC SPA
 CM81453130:
 SCOTSMAN ICE SRL
 CM25820114/Oex:
 CASTEL MAC SPA



DIMENSIONS
 492X422mm

4122118 SPLASH
 CURTAIN /
 SPLASH CURTAIN
 IOM210138701S:
 SCOTSMAN ICE SRL



4114747 ASS.VASC
 H.PARASPR.450/600 /
 SPLASH CURTAIN
 CM81453630:
 SCOTSMAN ICE SRL
 CM81453630/O:
 CASTEL MAC SPA



4114358 VASCHETT
 A CUBETTI MP60 /
 BASIN SET MP60
 9030329200:
 STAFF ICE SYSTEM
 SRL



4122124 CURTAIN /
 CURTAIN
 CM25550401/OEX:
 CASTEL MAC SPA
 0200461121:
 SCOTSMAN ICE SRL

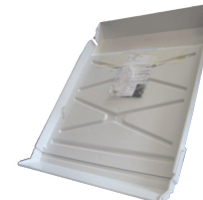

DIMENSIONS
 575X465mm

4122396 CURTAIN
 ASSY /
 CURTAIN ASSY
 CM25550400/O:
 CASTEL MAC SPA
 CM25550400:
 SCOTSMAN ICE SRL

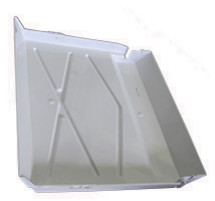
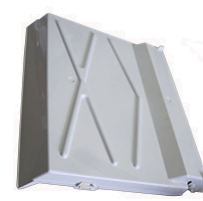

4114615 VASCHETT
A PARASPRUZZI
N500M /
TRAY SPLASH
GUARD N500M
25820120/0:
ICEMATIC
CM258201200:
CASTEL MAC SPA

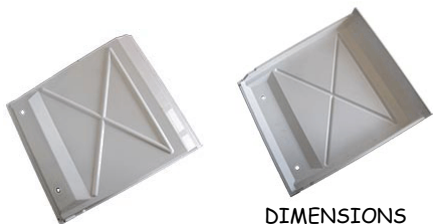

DIMENSIONS
565X495 mm

4122043 VASCHETT
A PARASPRUZZI
N120M /
PAN SPLASH N120M
CM25820123/0:
CASTEL MAC SPA

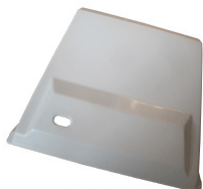

4122307 SPLASH
CURTAIN /
SPLASH CURTAIN
IOM2101355045:
SCOTSMAN ICE SRL

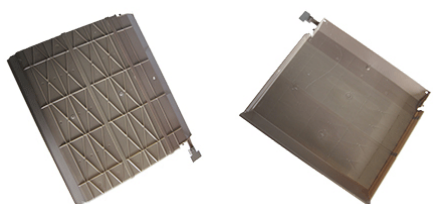

4114114 DEFLETTO
RE N250 /
DOOR DEFLECTOR
N250
CM81453131:
SCOTSMAN ICE SRL
CM81453008/0ex:
CASTEL MAC SPA
CM81453131/0:
CASTEL MAC SPA



4122164 CURTAIN /
CURTAIN
0200410032:
SCOTSMAN ICE SRL



DIMENSIONS
433X470mm

4114118 BACINELL
A RACCOLTA ACQUA
/
PAN WATER
COLLECTION
10395:
BREMA ICE MAKERS
SPA



4122219 BACINELL
A RACCOLTA ACQUA
/
WATER TRAY
10355:
BREMA ICE MAKERS
SPA



4122266 VASCHETT
A RICIRCOLO ACQUA
MOD.450...1000 07 /
TANK WATER
RECIRCULATING
MOD.450 ... 1000 07
CM25820130/0:
CASTEL MAC SPA



4114424 WATER
RESERVOIR /
WATER RESERVOIR
81453116/0:
ICEMATIC
CM81453010:
SCOTSMAN ICE SRL
CM81453116:
SCOTSMAN ICE SRL
CM81453116/0:
CASTEL MAC SPA

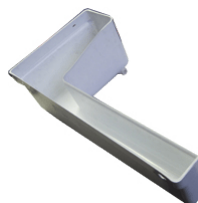

4114484 VASCHETT
A RICIRCOLO
MOD450/600/1000 /
TANK
MOD450/600/1000
25820125/0:
ICEMATIC
CM25820125:
SCOTSMAN ICE SRL
CM25820125/0*:
CASTEL MAC SPA



4122466 TROUGH
WATER /TROUGH
WATER
IOM905153701:
SCOTSMAN ICE SRL



DIMENSIONS
190X685mm

4114701 WATER
SUMP /
WATER SUMP
CM81453705:
SCOTSMAN ICE SRL

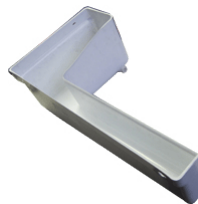

4114152 VASCHETT
A SCARICO ACQUA
N3-5-7- /
WATER DRAIN BASIN
N3-5-7
CM25820080/0:
CASTEL MAC SPA
CM25820080/0:
CASTEL MAC SPA

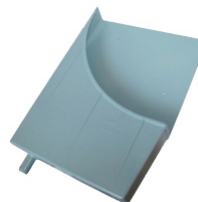

4114771 VASCHETT
A LATERALE N1-2 /
LATERAL WATER
DRAIN BASIN
25820083/0:
ICEMATIC
CM258200830:
CASTEL MAC SPA

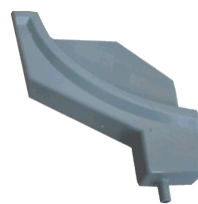

4114833 ASSIEME

BOCCA USCITA
GHIACCIO CON
MICRO /
SPOUT OUT ICE
ASSEMBLY WITH
MICRO

C10585:

BREMA ICE MAKERS
SPA



4122037 BACINELL

A FISSA /
FIXED BASIN

C10192:

BREMA ICE MAKERS
SPA



4114682 BACINELL

A ROTANTE /
ROTATING BASIN

10184:

BREMA ICE MAKERS
SPA



4122294 BACINELL

A ACQUA CON
ISOLAMENTO /
BASIN WATER WITH
INSULATION

C22443:

BREMA ICE MAKERS
SPA

NC22443: N.T.F. SRL



DIMENSIONS
250X125mm

4114911 CONDOTT

O MUSTER 350 /
MUSTER 350 DUCT

CONDOTTO M 350:

BREMA ICE MAKERS
SPA



4114656 ICE CHUTE

/
ICE CHUTE

66057307:

SIMAG SPA

66057307:

SCOTSMAN ICE SRL

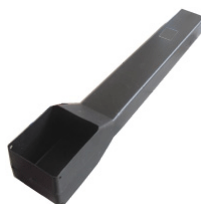

4122246 PLASTIC

CHUTE /
PLASTIC CHUTE

66045515:

SCOTSMAN ICE SRL



4122197 ICE CHUTE

/
ICE CHUTE

66057304:

SCOTSMAN ICE SRL



4114515 ICE CHUTE

/
ICE CHUTE

66047701:

SCOTSMAN ICE SRL



4114501 ICE CHUTE

CONNECTION /
ICE CHUTE

CONNECTION

79202602R:

SCOTSMAN ICE SRL



4114503 EXTRA

CONNECTION CHUTE

/
EXTRA CONNECTION
CHUTE

66055600:

SCOTSMAN ICE SRL



4114787 ICE CHUTE

/
ICE CHUTE

66047700:

SCOTSMAN ICE SRL



4122358 ICE CHUTE

LOWER /
ICE CHUTE LOWER

0200292904:

SCOTSMAN ICE SRL

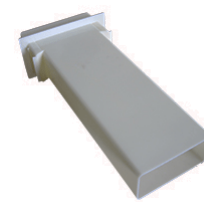

4114493 VASSOIO

GHIACCIO ϕ 495 mm /
INNER BOTTOM ϕ 495
mm

66048700:

SCOTSMAN ICE SRL

66048701:

SCOTSMAN ICE SRL



4122152 WATER

TRAY /
WATER TRAY

66090200:

SCOTSMAN ICE SRL



4122385 BOCCA
COMPLETA KF1000 /
SPOUT FULL KF1000
2CLO72: **MIGEL S.R.L.**



4122173 ICE SPOUT
/
ICE SPOUT
66102800:
SCOTSMAN ICE SRL



4122285 COPERTUR
A USCITA GHIACCIO /
ICE CHUTE COVER
0200293004:
SCOTSMAN ICE SRL



4122286 ICE CHUTE
BODY /
ICE CHUTE BODY
0200384101:
SCOTSMAN ICE SRL



COVER=4122285

4122418 ICE SPOUT
/
ICE SPOUT
66067600:
SCOTSMAN ICE SRL



4114497 ICE CHUTE
/
ICE CHUTE
66067500:
SCOTSMAN ICE SRL



4114115 SUPPORTO
VASCHETTA N 20 /
TANK REST N20
RECOC527:
EURFRIGOR SRL
RECOC527:
BRICE ITALIA SRL
CM25726473/0:
CASTEL MAC SPA
CM25726473:
SCOTSMAN ICE SRL



4122078 SUPP.POST.
BULBO TERM.RANCO
N-G F8-15 /
SUPPORT BACK BULB
THERMOSTAT N G-F8-
15
CM25726141/0:
CASTEL MAC SPA



4122079 SUPP.ANT.
BULBO TERM.RANCO
NIKE GAL.F8-15 /
SUPPORT FRONT
BULB THERMOSTAT
NIKE GAL.F8-15
CM25726140/0:
CASTEL MAC SPA



4114006 SUPPORTO
ALBERO PALETTE /
PADDLE SHAFT
RESSORT
25726115/3:
ICEMATIC
CM25726115:
SCOTSMAN ICE SRL
CM25726115/3:
CASTEL MAC SPA



4114352 SUPP.
PERNO DEFLETTORE
N1N25-35-45-50BI-55-
70-90 /
PIN DEFLECTOR
SUPPORT N1N25-35-
45-50BI-55-70-90
25726279/0:
ICEMATIC
CM2572679ex:
SCOTSMAN ICE SRL
CM25726478/0:
CASTEL MAC SPA
CM25726478:
SCOTSMAN ICE SRL
825726279:
GRUPPO CIMBALI
SPA



4114014 ASS.LEVA
RIBALTAMENTO N1-
2-3-5-7 /
UPSETTING LEVER
SET N1-2-3-5-7
825440110:
GRUPPO CIMBALI
SPA
CM25440110:
SIMAG SPA
81403011: **ICEMATIC**
CM25440110:
SCOTSMAN ICE SRL
25440110/0:
ICEMATIC
CM25440110/0:
CASTEL MAC SPA



PIN=1140010,
SPRING=1117013

4114040 ASSIEME
LEVA
RIBALTAMENTO N12-
222 /
OVERTURN LEVER
SET N12-222
CM81442071/0:
CASTEL MAC SPA



4122053 RH003616-
SPALLETTA IN
PLASTICA X
EVAPORATORE N /
RH003616 - BRACKET
PLASTIC X
EVAPORATOR N
910083:
BRICE ITALIA SRL

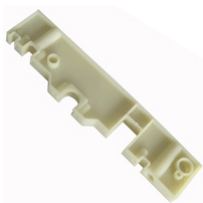

4114572 LEVA
ACCIAIO INOX /
STAINLESS STEEL
LEVER
1CR021: MIGEL S.R.L.



4114026 SUPPORTO
EVAPORATORE NIKE
/
EVAPORATOR REST
NIKE
CM25726121:
SCOTSMAN ICE SRL
CM25726121/0:
CASTEL MAC SPA



4114240 SUPPORTO
/ HOLDER FOR
EVAPORATOR RIGHT
25726122/0:
ICEMATIC
CM257261220:
CASTEL MAC SPA



4114238 SUPPORTO
PALETTE ICEMATIC /
SUPPORT ICEMATIC
25525419/0:
ICEMATIC
CM25525419:
SCOTSMAN ICE SRL
CM25525419:
CASTEL MAC SPA



4114022 SUPPORTO
MOTORIDUTTORE
PALETTE /
PADDLE MOTOR
BRACKET
CM25725433:
SCOTSMAN ICE SRL
CM25725433/0:
CASTEL MAC SPA
CM25725433:
SIMAG SPA
CM25725439/0:
CASTEL MAC SPA



825725433:
GRUPPO CIMBALI
SPA

4122030 ASSIEME
BIELLA EC130
COMPLETO /
CONNECTING ROD
COMPLETE
ASSEMBLY EC130
AS923069:
BRICE ITALIA SRL



4114473 BIELLA X
TESTATA EC N /
GUIDANCE
RH00A008:
EURFRIGOR SRL
910009:
BRICE ITALIA SRL
RH00A008:
EURFRIGOR ICE
MAKERS SRL



4114716 BIELLA
VASCETTA X
TESTATA EC 14 /
GUIDANCE FOR EC14
RH003618:
BRICE ITALIA SRL



4122470 LEVA x
PORTA N3-5-7-12-22
B3 /
DOOR LEVER N3-5-7-
12-22 B3
CM25431015/2:
CASTEL MAC SPA
CM254310152:
CASTEL MAC SPA



DIMENSIONS
199X17mm

4114558 SUPPORTO
MOTORIDUTTORE
PALETTE PLASTICA /
MOTO REDUCER
SUPPORT FOR ARM
RH000668:
EURFRIGOR SRL
RH000668:
EURFRIGOR ICE
910088:
BRICE ITALIA SRL



4114046 ENTRATA
ACQUA BACINELLA
NIKE /
INLETE PIPE FOR ICE
CUBE MAKER
825300000:
GRUPPO CIMBALI
SPA
CM25300000:
SCOTSMAN ICE SRL
CM25300000/0:
CASTEL MAC SPA
CM25300000:
SIMAG SPA



4114548 PLASTIC
PROTECTION LEFT /
PLASTIC
PROTECTION LEFT
66072000:
SCOTSMAN ICE SRL



4114549 PLASTIC
PROTECTION RIGHT /
PLASTIC
PROTECTION RIGHT
66072001:
SCOTSMAN ICE SRL



4114614 BACINELL
A CONDENSA /
CONDENSES BASIN
080803:
ELECTROLUX
PROFESSIONAL
S.P.A.

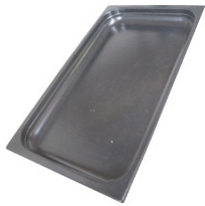

4114485 CURTAIN
BRACKET /
CURTAIN BRACKET
66046902:
SCOTSMAN ICE SRL

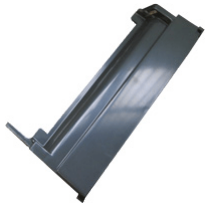

4122389 VASCHETT
A RACCOLTA
CONDENSA 415x120
mm /
DRIP TRAY 415x120
mm
CMCM1541060:
CASTEL MAC SPA
1541060:
MONDIAL GROUP
S.R.L.



DIMENSIONS
415x120 mm

4122072 VASCHETT
A ABS
EVAPORATORE (Q32-
0194) /
PAN EVAPORATOR
ABS (Q32-0194)
TDE072266:
MONDIAL GROUP
S.R.L.

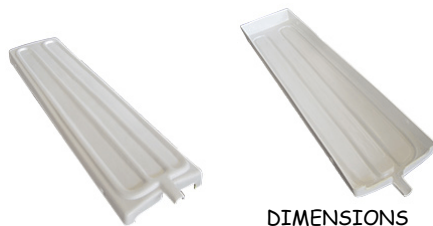

DIMENSIONS
430X100mm

4122214 SINK / SINK
0200294420:
SCOTSMAN ICE SRL

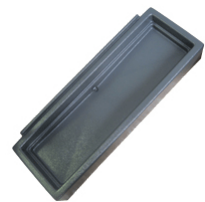

4114035 DEFLETT
RE PORTA N20-N25 /
DOOR DEFLECTOR
N20-N25

825250099:
GRUPPO CIMBALI
SPA

CM25250099:
SIMAG SPA

CM25250099/0:
CASTEL MAC SPA

CM25250099:

SCOTSMAN ICE SRL
25250099/0:

ICEMATIC

25260462/0:

ICEMATIC

CM25260462/0:

CASTEL MAC SPA



WIDTH= 205 mm,
LENGTH= 345 mm

4114966 DEFLETT
RE PORTA N21 /
DOOR DEFLECTOR
N21

CM252604750:

CASTEL MAC SPA

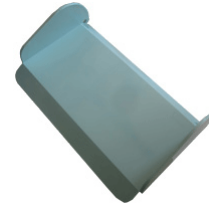

WIDTH= 160 mm,
LENGTH= 265 mm

4114934 DEFLETT
RE PORTA E23/
DOOR DEFLECTOR
E23

CM252501860:

CASTEL MAC SPA

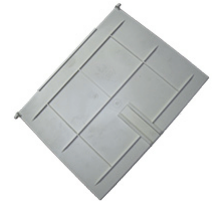

WIDTH= 205 mm,
LENGTH= 260 mm

4122272 DEFLETT
RE PORTA E25 /
DEFLECTOR DOOR
E25

CM252501850:

CASTEL MAC SPA

CM25250185:

SCOTSMAN ICE SRL



WIDTH= 205 mm,
LENGTH= 320 mm

4122032 DEFLETT
RE PORTA E35 /
DEFLECTOR DOOR
E35

CM25250187/0:

CASTEL MAC SPA

CM25250187:

SCOTSMAN ICE SRL



WIDTH= 205 mm,
LENGTH= 370 mm

4114370 DEFLETT
RE PORTA N30-50
BIANCO /
DOOR DEFLECTOR
N30-50

CM25260473:
SCOTSMAN ICE SRL
CM252604720ex:
CASTEL MAC SPA
CM25260473/0:
CASTEL MAC SPA

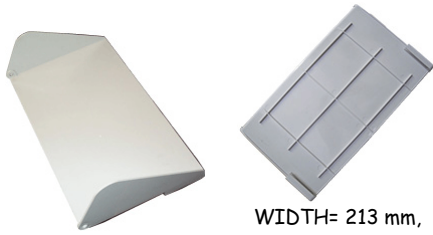

WIDTH= 213 mm,
LENGTH= 367 mm

4114054 DEFLETT
RE PORTA N30 /
DOOR DEFLECTOR
N30

825260452:
GRUPPO CIMBALI
CM25260452/0:
CASTEL MAC SPA
CM25260452:
SIMAG SPA
CM25260452:
SCOTSMAN ICE SRL



WIDTH = 213 mm,
LENGTH= 367 mm

4122201 DEFLETT
RE PORTA N2 G25 /
DEFLECTOR DOOR
N2 G25

CM252501060:
CASTEL MAC SPA

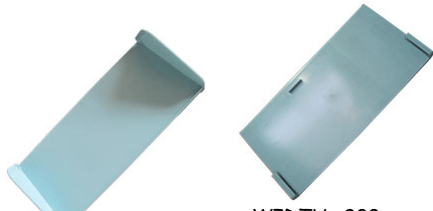

WIDTH= 200 mm,
LENGTH= 425 mm

4114085 DEFLETT
RE PORTA LX80 /
DOOR DEFLECTOR
LX80

CM25260470:
SCOTSMAN ICE SRL
CM25260470/0:
CASTEL MAC SPA

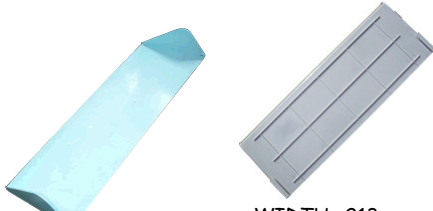

WIDTH= 213 mm,
LENGTH= 598 mm

4122464 DEFLETT
RE PORTA E75 /
DOOR DEFLECTOR
E75

CM25250190/0:
CASTEL MAC SPA



DIMENSIONS
245X620mm

4114338 DEFLETT
RE GHIACCIO N21 /
ICE DEFLECTOR N21

CM25260474/0:
CASTEL MAC SPA
CM25260474/0:
CASTEL MAC SPA



4114643 DEFLECTO
R ICE /
DEFLECTOR ICE
0200333701:
SCOTSMAN ICE SRL



4114892 ASSIEME
SPORTELLO 2.0 2.5 3.0
BLU 197X297MM /
BLUE DOOR
ASSEMBLY 2.0 2.5 3.0
K03401:
ARISTARCO SPA

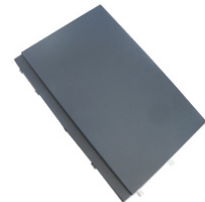

DIMENSIONS
197X297MM

4114191 SPORTELL
O GRIGIO CHIARO
CAVA LUNGA CB184 /
DOOR FOR ICE-
MAKER
CB184:
BREMA ICE MAKERS
SPA



DIMENSIONS
173X291mm

4114378 SPORT.GRI
GIORAL7031C.C.P.+CO
NTROSP.B.CO /
DOOR
10378:
BREMA ICE MAKERS
SPA
NI0378: N.T.F. SRL



DIMENSIONS
174X291mm

4114619 SPORTELL
O COLORE BLU CB184
/
BLUE DOOR CB184
10081:
BREMA ICE MAKERS
SPA



DIMENSIONS
173X292mm

4114109 ASSIEME
SPORTELLO /
DOOR ASSY
C10303:
BREMA ICE MAKERS
SPA

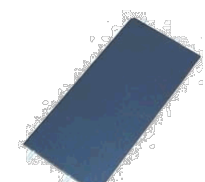

DIMENSIONS
195X336mm

4114665 ASS.SP
ORTELLO GRIGIO SL70-90-
110 /
DOOR FOR SL70-90-
110
NC10360: N.T.F. SRL
C10360:
BREMA ICE MAKERS
SPA



DIMENSIONS
204X445mm

4114106 ASS.
PORTELLO MEDIO
GRIGIO S/C /
GREY MIDDLE DOOR
SET S/C

11083:

BREMA ICE MAKERS
SPA

cb316:

BREMA ICE MAKERS
SPA

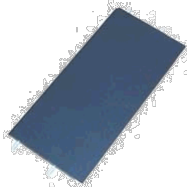

DIMENSIONS
208X446mm

4114038 ASSIEME
SPORTELLO
640/840/955/1565 /
DOOR SET 640/840/955

C10275:

BREMA ICE MAKERS
SPA



DIMENSIONS
300X675mm

4114599 PANNELLO
POSTERIORE /
BACK PANEL

21064:

BREMA ICE MAKERS
SPA

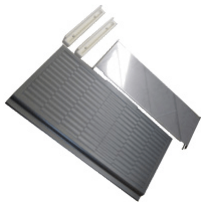

4114162 SPORTELL
O GRIGIO SCURO
CAVA LUNGA /
DOOR FOR ICE-CUBE
MAKER

10277:

BREMA ICE MAKERS



4122207 RPS0B884-
PORTA ECP20-27-
EC18-25 BLU RAL5011
/
DOOR ECP20-27 EC18-
25

AS910068:

BRICE ITALIA SRL

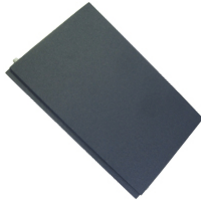

DIMENSIONS
313X200 mm

4122311 SPORTELL
O INOX COMPLETO
EC80-ECP75-ES /
STEEL DOOR
COMPLETE - EC80-
ECP75-ES

EC80-ECP75-ES:

BRICE ITALIA SRL

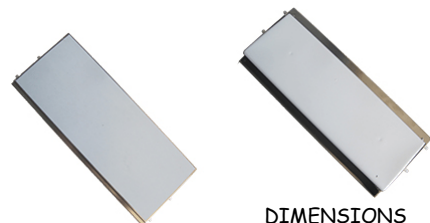

DIMENSIONS
590X240mm

4114382 DOOR
EURFRIGOR EC20-30-
40 /
DOOR EURFRIGOR
EC20-30-40

EC20-EC30-EC40:

EURFRIGOR SRL

K01899:

ARISTARCO SPA

EC20-EC30-EC40:

BRICE ITALIA SRL



DIMENSIONS
380X245mm

RP00A667:

BRICE ITALIA SRL

4114765 SPORTELL
O PER AECO-60W /
DOOR FOR AECO-60W

RP00A669:

EURFRIGOR SRL

RP00A672EX:

EURFRIGOR SRL

AS910070:

BRICE ITALIA SRL



DIMENSIONS
460X250mm

4122036 PORTA
LISCIA BLU RAL 5011
EC80 ECP72 /
DOOR SMOOTH BLUE
RAL 5011 EC80 ECP72

910071:

BRICE ITALIA SRL



DIMENSIONS
585X245MM

4114796 PORTA
ACCIAIO ES200/EC130
/
STAINLESS STEEL
DOOR ES200/EC130

RP003681:

EURFRIGOR

RP00A313:

EURFRIGOR SRL

RP00A516:

EURFRIGOR SRL

AS922102:

BRICE ITALIA SRL

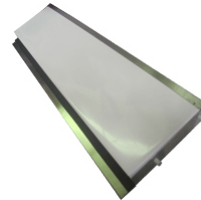

4122299 PORTELLO
N30T-N55T GRIGIA /
DOOR-N30T N55T
GRAY

CM81419908/0:

CASTEL MAC SPA



DIMENSIONS
450X350

4122087 ASSIEME
PORTA IX E25 /
DOOR ASSEMBLY IX
E25

CM81400018/0:

CASTEL MAC SPA



4122486 ASS.PORTA
NX25 343X195mm /
COMPLETE DOOR
NX25 343X195mm

CMNX78207957:

CASTEL MAC SPA



DIMENSIONS
195X343mm

4114584 ASSIEME
PORTA D201-CTB150 /
DOOR ASSEMBLY
D201-CTB150
81430351/0:
ICEMATIC
81460351/0:
ICEMATIC
CM81460351:
SCOTSMAN ICE SRL
CM81460351/0:
CASTEL MAC SPA



DIMENSIONS
289X720mm

4114235 PORTA
INOX COMPLETA
ICEMATIC 80KG /
DOOR INOX
ICEMATIC 80 KG
81420528/0:
ICEMATIC
81420505/0:
ICEMATIC
CM81420505/0EX:
CASTEL MAC SPA
CM81420528/0:
CASTEL MAC SPA

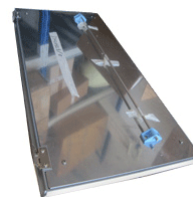

DIMENSIONS
345X680mm

4114125 ASSIEME
PORTA D 200
770X295mm /
DOOR ASSEMBLY D
200 770X295mm
CM814601830:
CASTEL MAC SPA
CM81460183:
CASTEL MAC SPA
CM81460183:
SCOTSMAN ICE SRL

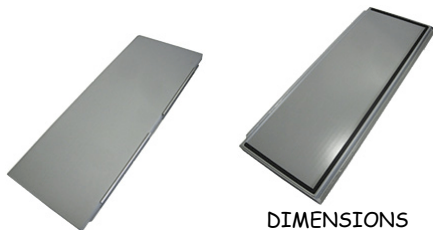

DIMENSIONS
770X295mm

4114360 ASS.SPORT
ELLO B350-B550 /
DOOR B350-B550
81460326/0:
ICEMATIC
CM81460326:
SCOTSMAN ICE SRL
CM81460326/0:
CASTEL MAC SPA



4114351 PORTA
N25S VERNIC.GRIGIO
/
DOOR N25S
25600187/0:
ICEMATIC
256001740:
ICEMATIC
CM25600187:
SCOTSMAN ICE SRL
CM25600187/0:
CASTEL MAC SPA

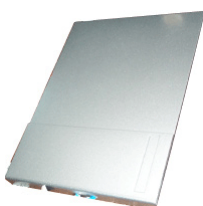

DIMENSIONS
338X346mm

4122415 7552
SLIDING DOOR Q60C
INOX /
SLIDING DOOR Q60C
INOX
407552: I.T.V. S.A.

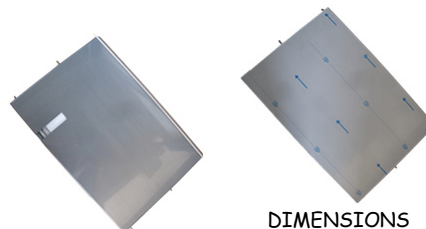

DIMENSIONS
510X350mm

4122473 ASSIEME
PORTA IX E35 /
DOOR ASSEMBLY IX
E35
CM814000750:
CASTEL MAC SPA

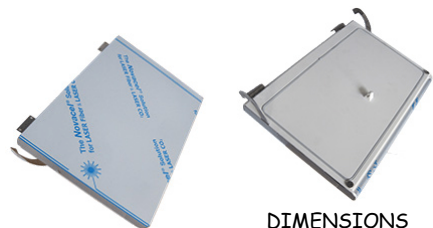

DIMENSIONS
410X285mm

4122367 SPORTELL
O KL41/51/61-KF75
COMPLETO
430X261mm /
COMPLETE DOOR KL
41/51/61-KF75 -
430X261mm
KL41,KL51,KL61,KF75:
MIGEL S.R.L.

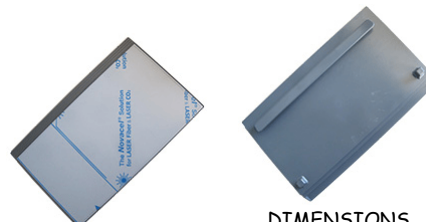

DIMENSIONS
430X261mm

4114236 PORTA
ICEMATIC 30 KG /
DOOR FOR ICEMATIC
30 KG
81401650/0:
ICEMATIC
CM81401572/0EX:
CASTEL MAC SPA
81401572/0:
ICEMATIC
81400700/0:
ICEMATIC
CM81400700EX:
CASTEL MAC SPA
CM81401650/0:
CASTEL MAC SPA
CM81401650:
SCOTSMAN ICE SRL

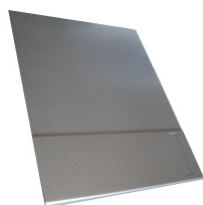

DIMENSIONS
450X348mm

4114593 SPORTELL
O KL21/KP20
COMPLETO /
DOOR KL21/KP20
2CL014: MIGEL S.R.L.

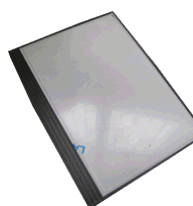

4114071 SPORTELL
O X FABBRICATORE
SL 35 /
ICE-MAKER DOOR SL
35
CF07900010:
N.T.F. SRL

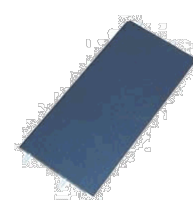

4114676 ASSIEME
PORTELLO /
BIN DOOR ASSY
78209204R:
SCOTSMAN ICE SRL

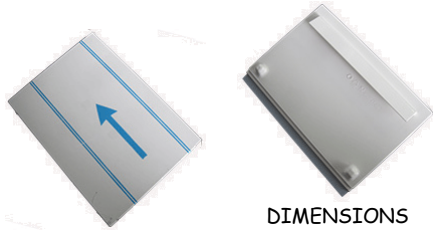

DIMENSIONS
210X290mm

4122263 ASSIEME
SPORTELLO /
BIN DOOR ASSY
78210216R :
SCOTSMAN ICE SRL

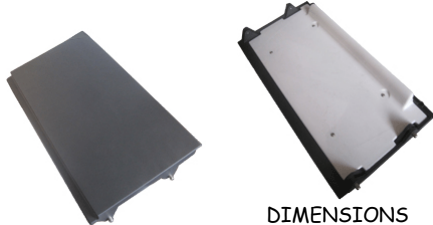

DIMENSIONS
260X485mm

4114974 PORTELLO
NTF X SL 140-180-260 /
NTF DOOR FOR SL
140-180-260
SL140-SL180-SL260:
N.T.F. SRL



DIMENSIONS
297X674mm

4114639 ASSIEME
SPORTELLO GRIGIO
SL50-60 /
ASSEMBLY DOOR
GREY SL50-60
SL50-60: N.T.F. SRL

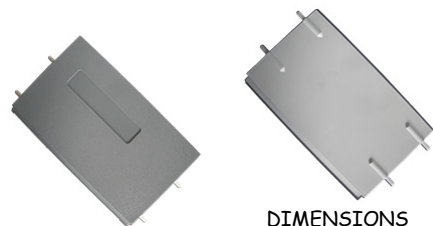

DIMENSIONS
210X337mm

4114157 SPORTELL
O ASSIEM. GRIGIO /
DOOR
66057201:
SCOTSMAN ICE SRL

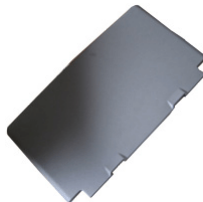

DIMENSIONS
214X394mm

4114166 SPORTELL
O SCOTSMAN /
DOOR ASSY
SCOTSMAN
79200909R:
SCOTSMAN ICE SRL



DIMENSIONS
258X589mm

4114279 BIN DOOR
ASSY /
BIN DOOR ASSY
78150300R:
SCOTSMAN ICE SRL
79201102R:
SCOTSMAN ICE SRL



DIMENSIONS
273X502mm

4114491 BIN DOOR /
BIN DOOR
CM81460355:
SCOTSMAN ICE SRL



DIMENSIONS
309X770mm

4114768 BIN DOOR /
BIN DOOR
0200343931:
SCOTSMAN ICE SRL



DIMENSIONS
330X700mm

4114204 BIN DOOR
ASSY /
BIN DOOR ASSY
78207905R:
SCOTSMAN ICE SRL

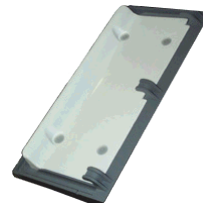

DIMENSIONS
200X420mm

4122494 BIN DOOR
ASSY /
BIN DOOR ASSY
78207963R:
SCOTSMAN ICE SRL



DIMENSIONS
200X418mm

4122480 BIN DOOR
ASSY 287X210mm /
BIN DOOR ASSY
287X210mm
66076604:
SCOTSMAN ICE SRL

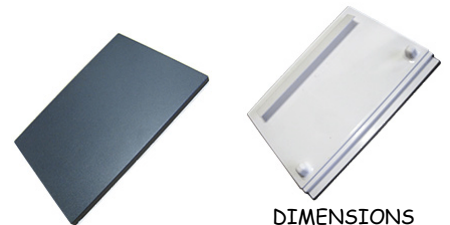

DIMENSIONS
210X287mm

4114192 KIT
SPORTELLO/CREMAG
.BL65/90 /
BIN DOOR ASSY
BL65/90
06051704:
SCOTSMAN ICE SRL

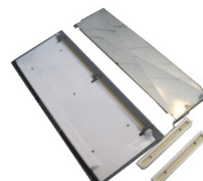

DIMENSIONS
260X655mm

4114658 BIN DOOR
COMPLETE WITH
FRAME /
BIN DOOR
CM81460373:
SIMAG SPA
CM81460373:
SCOTSMAN ICE SRL
B193:
SCOTSMAN ICE SRL
CM814605730:
CASTEL MAC SPA



4114922 BIN DOOR
ASSY /
BIN DOOR ASSY
78210800R:
SCOTSMAN ICE SRL

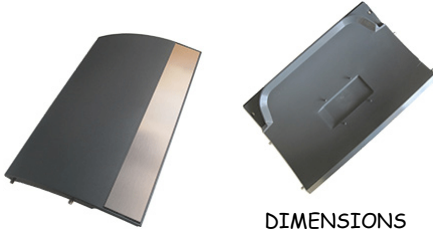

DIMENSIONS
505X335mm

4114201 BIN DOOR
ASSY /
BIN DOOR ASSY
78209104REX:
SCOTSMAN ICE SRL
78210000R:
SCOTSMAN ICE SRL



4114211 PORTELLO
BARLINE /
DOOR BARLINE
78207900R:
SCOTSMAN ICE SRL

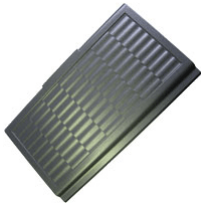

4114509 BIN DOOR
ASSY /
BIN DOOR ASSY
78210019R:
SCOTSMAN ICE SRL
78209116REX:
SCOTSMAN ICE SRL
78209100R:
SCOTSMAN ICE SRL

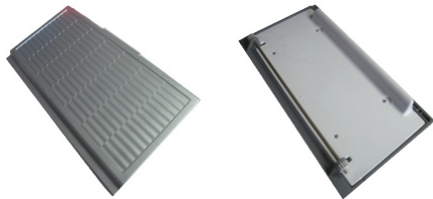

4122183 BIN DOOR
ASSY /
BIN DOOR ASSY
CMNX78210224:
CASTEL MAC SPA
78210224R:
SCOTSMAN ICE SRL



4122424 "BIN DOOR
ASSY 26"" /
BIN DOOR ASSY 26
0200430620:
SCOTSMAN ICE SRL

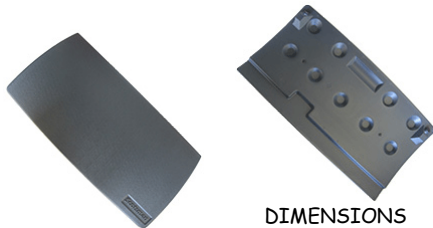

DIMENSIONS
610X324mm

4122479 BIN DOOR
450X333mm /
BIN DOOR 450X333mm
66099700:
SCOTSMAN ICE SRL

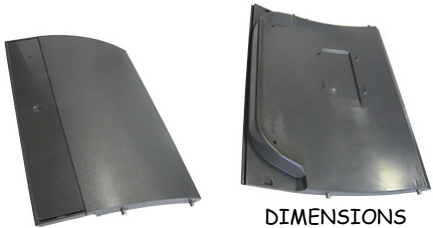

DIMENSIONS
450X333mm

4122196 BIN DOOR /
BIN DOOR
66078600:
SCOTSMAN ICE SRL

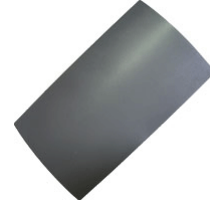

4122179 BIN DOOR
ASSY /
78210221REX:
SCOTSMAN ICE SRL



4122168 BIN DOOR
ASSY /
BIN DOOR ASSY
78207939R:
SCOTSMAN ICE SRL



4122169 BIN DOOR /
BIN DOOR
0A03393820:
SCOTSMAN ICE SRL



4122026 BIN DOOR
ASSY /
BIN DOOR ASSY
78210210R:
SCOTSMAN ICE SRL

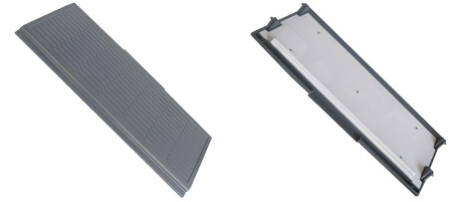

4122007 BINDOORA
SSY /
BIN DOOR ASSY
06049125EX:
SCOTSMAN ICE SRL



4114957 BIN DOOR
ASSY /
BIN DOOR ASSY
78210206R:
SCOTSMAN ICE SRL



4114968 BINDOOR /
BINDOOR
66064200:
SCOTSMAN ICE SRL

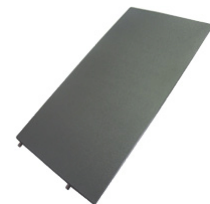

4114822 BIN DOOR
ASSY /
BIN DOOR ASSY
78209206R:
SCOTSMAN ICE SRL



4114804 BIN DOOR /
BIN DOOR
66078601:
SCOTSMAN ICE SRL

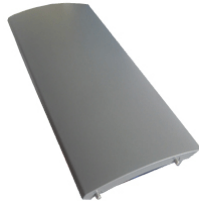

4114774 BIN DOOR /
BIN DOOR
78209106EX:
SIMAG SPA
78210002R:
SCOTSMAN ICE SRL
78209106EX:
SCOTSMAN ICE SRL

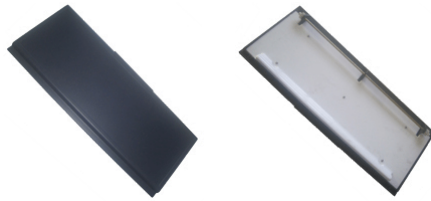

4114596 BIN DOOR
ASSY /
BIN DOOR ASSY
CM81460374:
SCOTSMAN ICE SRL

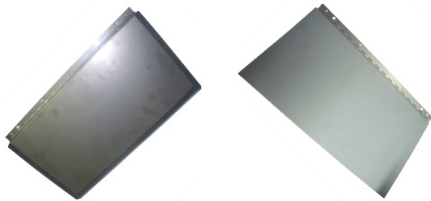

4114559 BIN DOOR
KIT /
BIN DOOR KIT
06051700:
SCOTSMAN ICE SRL



4114415 TELAIO
CON GRIGLIA E
FILTRO /
FRAME WITH GRID
AND FILTER
C10205:
BREMA ICE MAKERS
SPA

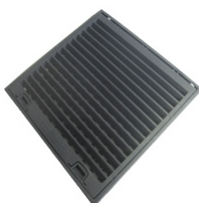

DIMENSIONS
250X260mm

4122044 PRESA
D'ARIA NERA /
AIR INTAKE BLACK
CM28295030/0:
CASTEL MAC SPA



DIMENSIONS
231X231mm

4114723 PRESA
D'ARIA N35S /
AIR INTAKE
25610103/0:
ICEMATIC
CM25610103/0:
CASTEL MAC SPA



CM256101030:
CASTEL MAC SPA

4114724 FRONT
UPPER PANEL /
FRONT UPPER PANEL
25175226/0:
ICEMATIC
CM25715226/0:
CASTEL MAC SPA
CM251752260:
CASTEL MAC SPA
CM25175226:
SCOTSMAN ICE SRL

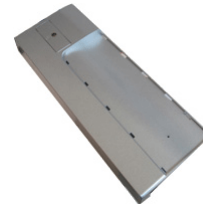

4122058 ASSIEME
GRIGLIA POSTERIORE
CR N12-22 /
GRID BACK
ASSEMBLY CR N12-22
CM81440404/0:
CASTEL MAC SPA



DIMENSIONS
750X235mm

4122027 COPERCHI
ETTO COMANDI N /
COVER COMMANDS
N
CM251611380:
CASTEL MAC SPA

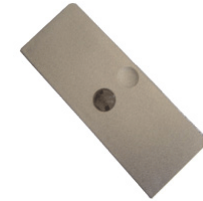

4114809 GRIGLIA
PER FIANCO BLU RAL
5011 EC/ES /
GRID FOR EC/ES
RN00B333:
EURFRIGOR SRL
912009:
BRICE ITALIA SRL

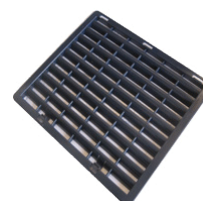

4122503 PLASTIC
LOUVER COVER /
PLASTIC LOUVER
COVER
0200422401:
SCOTSMAN ICE SRL



DIMENSIONS
260X345mm

4114607 CONTROL
BOX COVER /
CONTROL BOX
COVER
25161143/0:
ICEMATIC
CM25161143:
SCOTSMAN ICE SRL
CM25161143/0EX:
CASTEL MAC SPA
CM25161164/0:
CASTEL MAC SPA

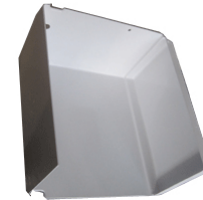

4122123 COPRIVEN
TILATORE TANG.BEV
BIANCO -> /
Tangential fan cover
BEV WHITE
1721401:
MONDIAL GROUP
S.R.L.



4122432 ROLL.BON
D BEV/KIC BIANCO /
ROLL.BOND BEV/KIC
WHITE
4133007:
MONDIAL GROUP
S.R.L.



DIMENSIONS
1000X470mm

4122438 COPRIEVA
PORATORE BEV PV40
BIANCO -> /
COVER FOR
EVAPORATOR BEV
PV40 WHITE
1721625:
MONDIAL GROUP
S.R.L.



DIMENSIONS
390X360X100Hmm

4122176 COPRIEVA
PORATOREV.DRINK
P310-410-> /
COVER EVAPORATOR
V.DRINK P310-410->
1743042:
MONDIAL GROUP
S.R.L.



4122008 Carter di
protezione cella/pompa /
Protective cover cell /
pump
N22763: N.T.F. SRL
EU22763:
BRICE ITALIA SRL
22763:
BREMA ICE MAKERS
SPA



4137091 GRID /
GRID
65076500:
SCOTSMAN ICE SRL



4114875 PROTEZIO
NE BACINELLA /
BASIN COVER
10508:
BREMA ICE MAKERS
SPA



4122091 COVER,
EVAPORATOR /
COVER,
EVAPORATOR
74107501:
SCOTSMAN ICE SRL



4114482 RACK /
RACK
66061600:
SCOTSMAN ICE SRL
NM66061600:
ICEMATIC
CMNM66061600:
CASTEL MAC SPA



4114495 SUPPORT /
SUPPORT
66030200:
SCOTSMAN ICE SRL



4122233 EVAPORAT
OR PLATEN /
EVAPORATOR
PLATEN
66066400:
SCOTSMAN ICE SRL

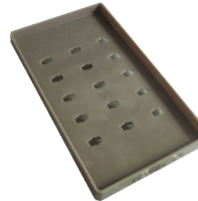

4122054 PLASTIC
COVER /
PLASTIC COVER
66090600:
SCOTSMAN ICE SRL



4114148 COPERTUR
A /
COVER
66036300:
SCOTSMAN ICE SRL



4122395 MOTOR
COVER /
MOTOR COVER
CMCF65051501:
CASTEL MAC SPA
65051501:
SCOTSMAN ICE SRL



4122394 PLASTIC
COVER /
PLASTIC COVER
65051502:
SCOTSMAN ICE SRL
CMCF65051502:
CASTEL MAC SPA



3108574 TAPPO

art.6930 NERO /
BLACK CAP

10375:

BREMA ICE MAKERS
SPA



4114617 PLASTIC

PLUG /
PLASTIC PLUG

NM66074100:

ICEMATIC

CMNM66074100:

CASTEL MAC SPA

66074100:

SCOTSMAN ICE SRL



spring= 1117203

4114943 PLASTIC

PLUG /
PLASTIC PLUG

66041900:

SCOTSMAN ICE SRL



4122159 CAP WORM

/
CAP WORM

73410500:

SCOTSMAN ICE SRL



4122459 PANNELLO

ANT. GRIGLIATO
COLORE BLU /
BLUE FRONT GRID
PANEL

10063:

BREMA ICE MAKERS
SPA

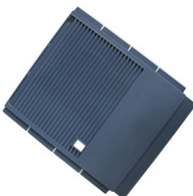

DIMENSIONS
380X270mm

4114309 COPERCHI

O MACCHINA N20LW
SB /
COVER MACHINE
N20LW SB

25161039/0:

ICEMATIC

25161106/0:

ICEMATIC

CM25161039/0:

CASTEL MAC SPA

CM25161106/0:

CASTEL MAC SPA

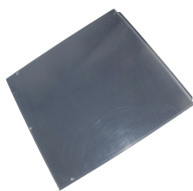

DIMENSIONS
437X400mm

4122112 COPERCHI

O N75T GRIGIO /
COVER GREY N75T

CM25161050/0:

CASTEL MAC SPA

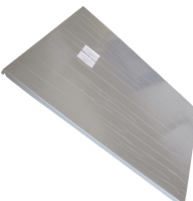

4114776 PANNELLO

SUPERIORE /
TOP PANEL

72201400:

SCOTSMAN ICE SRL



DIMENSIONS
680X450mm

4114464 MOBILE

INNER BOTTOM /
MOBILE INNER
BOTTOM

66048801:

SCOTSMAN ICE SRL

EX66048800:

SCOTSMAN ICE SRL



4122255 PLASTIC

FRAME /
PLASTIC FRAME

CM25165522/0:

CASTEL MAC SPA

CM25165522:

SCOTSMAN ICE SRL



4114582 ASSIEME

CORNICE FRONTALE
D201 30 /

ASSEMBLY FRAME
FRONT D201 30

81460359/0:

ICEMATIC

CM81460359/0:

CASTEL MAC SPA



4114664 "CORNICE

FRONT. B393 30" " /
DOOR FRAME

CM25165544:

SCOTSMAN ICE SRL

CM251655440:

CASTEL MAC SPA



4122440 BIN DOOR

FRAME /
BIN DOOR FRAME

CM25702909:

SCOTSMAN ICE SRL

CM257029090:

CASTEL MAC SPA



4114110 CORNICE

VERN/GOFF.RAL7042 /
FRAME EMBOSSED
PATENT RAL7042

25165499/0:

ICEMATIC

CM25165499:

SCOTSMAN ICE SRL

CM25165499/0:

CASTEL MAC SPA



4122496 CORNICE

PORTA E35 /
DOOR FRAME E35

CM25165561:

SCOTSMAN ICE SRL

CM251655610:

CASTEL MAC SPA



DIMENSIONS
355X430mm

4122093 BIN DOOR

FRAME ONLY /
BIN DOOR FRAME
ONLY

66064100:

SCOTSMAN ICE SRL



4114508 BIN DOOR

FRAME ASSY /
BIN DOOR FRAME
ASSY

78207812R:

SCOTSMAN ICE SRL

78207810REX:

SCOTSMAN ICE SRL

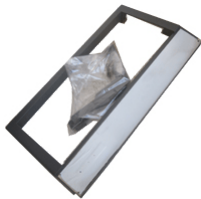

4122443 KIT

RETROFIT B393 -
Y2011 BIN DOOR AND
FRAME ASSY /
KIT RETROFIT B393 -
Y2011 BIN DOOR AND
FRAME ASSY

CM81460572:

SCOTSMAN ICE SRL

CM81460572/0:

CASTEL MAC SPA

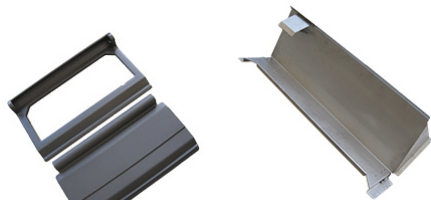

DOOR DIMENSIONS
420X760mm

4114646 TOP PANEL

ASSY GREY /
TOP PANEL ASSY
GREY

66049008:

SCOTSMAN ICE SRL

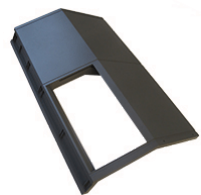

4114357 GR.

TELAIO VASCETTA
MP60/80 /
TANK FRAME MP60/80

9016129200:

STAFF ICE SYSTEM

SRL



4122258 CELLA

INTERNA /
CELL INTERNAL

10064:

BREMA ICE MAKERS

SPA



4122116 CELLA

SCHIUMATA EC130-
ES200-ECP105 /
CELL foam EC130-
ES200-ECP105

AS910040:

BRICE ITALIA SRL

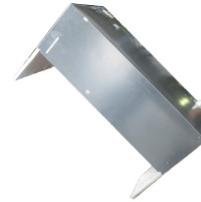

4114812 CELLA

INTERNA ECP 18/22 /
INTERNAL CELL
ECP18/22

RPS0B792:

EURFRIGOR SRL

910015:

BRICE ITALIA SRL

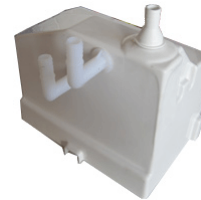

4114772 EVAP.

HOUSING /
EVAP.HOUSING

25135163/0:

ICEMATIC

CM25135163:

SCOTSMAN ICE SRL

CM25135163/0:

CASTEL MAC SPA



4114606 EVAPORAT

OR HOUSING /
EVAPORATOR
HOUSING

66066101R:

SCOTSMAN ICE SRL



4122006 EVAPORAT

OR ASSY /
EVAPORATOR ASSY

78434400R:

SCOTSMAN ICE SRL



4114621 BOCCHETT

A OTTONE F100-200 /
KIT SPOUT - ICE
LEVEL CTRL F100-200

CF75400400:

ICEMATIC

06058400:SCOTSMAN

N

CMCF75400400:

CASTEL MAC SPA



4114767 PLASTIC

SPOUT /
PLASTIC SPOUT

66067603:

SCOTSMAN ICE SRL



4114210 BACINELL
A DOPPIO MICRO /
DOUBLE MICRO
BASIN (K600042)
BREMA

C10145:

**BREMA ICE MAKERS
SPA**



4122354 ASSIEME
BACINELLA DOPPIO
MICRO SLF225 /
ASSEMBLY BASIN
DOUBLE MICRO SLF
225

C10408ex:

BREMA ICE MAKERS

C10681:

BREMA ICE MAKERS



4122340 ASSIEME
BACINELLA DOPPIO
MICRO G280 BREMA /
ASSEMBLY BASIN
DOUBLE MICRO G 280
- BREMA

EUC10685:

BRICE ITALIA SRL

NC10685: N.T.F. SRL

C10685:

**BREMA ICE MAKERS
SPA**



4122254 ASSIEME
BACINELLA DOPPIO
MICRO NEW GB1540
BREMA /
ASSEMBLY BASIN
DOUBLE MICRO NEW
BREMEN GB1540

C10706:

**BREMA ICE MAKERS
SPA**



4114242 ASSIEME
BACINELLA DOPPIO
MICRO /
BASIN SET DOUBLE
MICRO G500

C10314:

**BREMA ICE MAKERS
SPA**



4114287 ASSIEME
BACINELLA DOPPIO
MICRO /
BASIN SET DOUBLE
MICRO

C10200GBEX:

**BREMA ICE MAKERS
SPA**

C10707:

**BREMA ICE MAKERS
SPA**



4122453 ASSIEME
BACINELLA DOPPIO
MICRO NEW SLF355 /
DOUBLE MICRO
BASIN - NEW SLF355

C10683:

**BREMA ICE MAKERS
SPA**



4114168 GALLEGGI
ANTE TRASP. +
MICRO P.G.SC. /
FLOATER + MICRO
SWITCH

RH00C794:

EURFRIGOR SRL

RH000828:

EURFRIGOR SRL

RH00B632:

EURFRIGOR SRL

RH00B632:

**EURFRIGOR ICE
MAKERS SRL**

RH000828:

**EURFRIGOR ICE
MAKERS SRL**

RH00B632:

BRICE ITALIA SRL



4122165 5231
VASCHETTA ACQUA
CON GALLEGGIANTE
/

5231 BASIN WATER
WITH FLOAT

305231: I.T.V. S.A.



4114513 VASCHETT
A ACQUA COD. 600043
/
BASIN SET CODE
600043

2DR042: MIGEL

S.R.L.



4114728 ASSIEME
BACINELLA
DOPPIO MICRO /
NC10452: N.T.F. SRL



4114459 WATER
RESERVOIR /
WATER RESERVOIR
79312601:

SCOTSMAN ICE SRL



4114896 ASS.
RAMPA P.38 28 30
M11X1 /
SPRAY BAR
ASSEMBLY P.38 28 30
M11X1
K02203EX:
ARISTARCO SPA
K02897:
ARISTARCO SPA



JETS=6, L=333mm

4122351 ASSIEME
RAMPA P.38 130 300
PVC /
ASSEMBLY SPRAY
BAR - P.38 130,300 PVC
K02900:
ARISTARCO SPA



JETS=18, L=725mm

4114104 ASSIEME
RAMPA
SPRUZZATORI SL50-
60 /
SPRAY RAMP SET
SL50-60
C20572: N.T.F. SRL
C20572:
BREMA ICE MAKERS
SPA



JETS=6, L=329mm

4114041 ASSIEME
RAMPA
SPRUZZATORE
246/249 /
SPRAY RAMP ASS
246/249
C20028:
BREMA ICE MAKERS
SPA

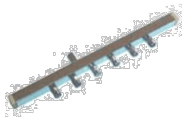

JETS=6, L=331mm

4114051 ASSIEME
RAMPA
SPRUZZATORE 640-
840 15 GETTI /
SPRAY RAMP SET 640-
840
C20058:
BREMA ICE MAKERS
SPA

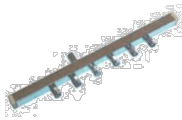

JETS=15, L=671mm

4122150 Assieme
rampa spruzzatori L= 440
mm /
ramp sprayers assembled
L = 440 mm
C20582:
BREMA ICE MAKERS
SPA



L= 440 mm

4114314 ASSIEME
RAMPA
SPRUZZATORI /
SPRAY RAMP SET
440mm
C20189:
BREMA ICE MAKERS
SPA



JETS=11, L=440mm

4114343 ASSIEME
RAMPA
SPRUZZATORI /
SPRAY RAMP SET
C20466:
BREMA ICE MAKERS
SPA
C20617:
BREMA ICE MAKERS
SPA



JETS=6

4114003 ASSIEME
RAMPA
SPRUZZATORI 40KG /
SPRAY ROD KIT 40KG
C20029:
BREMA ICE MAKERS
SPA



JETS=9, L=440mm

4114199 ASSIEME
RAMPA
SPRUZZATORI /
SPRAY ARM
C20573:
BREMA ICE MAKERS
SPA



JETS=9, L=440mm

4114486 ASSIEME
RAMPA
SPRUZZATORI /
SPRAY BAR
COMPLETE
68020156:
RANCILIO SPA
C20156:
BREMA ICE MAKERS
SPA



JETS=11, L=671mm

4122490 ASSIEME
RAMPA
SPRUZZATORI CUB. E
SL140. 675mm /
SPRAY BAR
ASSEMBLY SL140
675mm
C20804:
BREMA ICE MAKERS
SPA



JETS= 12, L=675mm

4114209 ASSIEME
RAMPA
SPRUZZATORI C80 /
SPRAY ARM 785mm 18
NOZZLES
C20459:
BREMA ICE MAKERS
SPA



JETS=18, L=786mm

4114066 ASSIEME
RAMPA
SPRUZZATORI C1265 /
SPRAY RAMP SET C80
C20144:
BREMA ICE MAKERS
SPA



JETS=18, L=717mm

4114363 ASSIEME
RAMPA
SPRUZZATORI /
ASSEMBLY RAMP
SPRAY

C20155:

BREMA ICE MAKERS
SPA



JETS=7, L=441mm

4122111 RAMPA
SPRUZZATORI /
RAMP SPRAY

CM257914560:

CASTEL MAC SPA



L= 243 mm

4122186 SPRAY
BAR (L267mm JETS 6
PCS) /
SPRAY BAR (L267mm
JETS 6 PCS)

CMXP65066512:

CASTEL MAC SPA

65066512:

SCOTSMAN ICE SRL



JETS=6, L=267mm

4122407 7485
DISTRIBUTOR NG-1 50

7485 DISTRIBUTOR
NG-1 50

407485: I.T.V. S.A.

7485: I.T.V. S.A.



L=786mm

4114805 SPRAY
BAR /
SPRAY BAR

65066501:

SCOTSMAN ICE SRL



JETS=6, L=241mm

4114654 SPRAY
BAR / SPRAY BAR

65066518:

SIMAG SPA

889124815:

GRUPPO CIMBALI

SPA

65066518:

SCOTSMAN ICE SRL



JETS=6, L=242mm

4114271 ASSIEME
RAMPA

SPRUZZATORI
SL140/200-M /
ASSEMBLY RAMP
SPRAY SL140/200-M

NC20575: N.T.F. SRL

EUC20575:

BRICE ITALIA SRL



JETS= 15,
LENGTH= 670 mm

4114305 ASSIEME
RAMPA
SPRUZZATORI /
SPRAY RAMP SET

NC20157: N.T.F. SRL

C20157:

BREMA ICE MAKERS
SPA



JETS=14, L=718mm

4114440 COLLETTO
RE KL21 /
COLLECTOR KL21

2LV016: MIGEL S.R.L.



JETS=6, L=250mm

4114945 COLLETTO
RE KL31 /
SPRAY BARS KL31

2LV017: MIGEL S.R.L.



JETS=8, L=329mm

4114441 COLLETTO
RE KX31 /
COLLECTOR KX31

2LV028: MIGEL S.R.L.



JETS=7, L=330mm

4114715 COLLETTO
RE KL41/51/61 /
COLLECTOR
KL41/51/61

2LV018: MIGEL S.R.L.



JETS=9, L=395mm

4114423 COLLETTO
RE KX41/51/61 /
COLLECTOR
KX41/51/61

2LV029: MIGEL S.R.L.



JETS=9, L=396mm

4114396 COLLETTO
RE KL131 /
COLLECTOR KL131

2LV020: MIGEL S.R.L.



JETS= 23, LENGTH=
900 mm

4114412 COLLETTO
RE KL171/301 /
COLLECTOR
KL171/301

2LV023: MIGEL S.R.L.



4114465 SPRAY
BAR / SPRAY BAR

65066517:

SIMAG SPA

65066517:

SCOTSMAN ICE SRL



JETS=8, L=314mm

4114289 SPRAY
BAR / SPRAY BAR

65066519:

SCOTSMAN ICE SRL



JETS=8, L=384mm

4114948 SPRAY
BAR /
SPRAY BAR

65066505:

SCOTSMAN ICE SRL



JETS=8, L=385mm

4122135 SPRAY
BAR / SPRAY BAR

65066502:

SCOTSMAN ICE SRL



JETS=8, L=387mm

4122228 RAMPA
SPRUZZATORI /
SPRAY BAR

65066524:

SCOTSMAN ICE SRL



JETS=8, L= 419 mm

4122226 SPRAY
BAR /
SPRAY BAR 15 JETS

65066508:

SCOTSMAN ICE SRL



JETS=15, L=570mm

4114976 SPRAYTUB
E /
SPRAYTUBR

CM81453575/0:

CASTEL MAC SPA

CM81453575:

SCOTSMAN ICE SRL



4114504 ASSY
SPRUZZATORE /
SPRAY ASSY

0A02548001:

SCOTSMAN ICE SRL



4114084 ASSIEME

RAMPA
SPRUZZATORI
SCOTSMAN /
SPRAY SYSTEMS FOR
ICE MAKER
SCOTSMAN

79312901:

SCOTSMAN ICE SRL



DIMENSIONS
210X287mm

4122428 SPRAY
SYSTEM /
SPRAY SYSTEM

79312910:

SCOTSMAN ICE SRL



DIMENSIONS
225X287mm

4114553 SPRAY
SYSTEM /
SPRAY SYSTEM

79312905:

SCOTSMAN ICE SRL



DIMENSIONS
147X273mm

4114519 SPRAY
SYSTEM ASSY /
SPRAY SYSTEM ASSY

79312904:

SCOTSMAN ICE SRL



DIMENSIONS
180X273mm

4114956 SPRAYSYS
TEM /
SPRAYSYSTEM

79312909:

SCOTSMAN ICE SRL

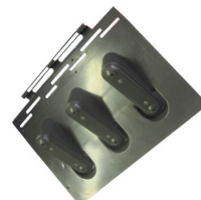

DIMENSIONS
211X286mm

4122388 ANELLO
SPRUZZATORE
COMPLETO /
RING COMPLETE
SPRAYER

C20882:

BREMA ICE MAKERS

SPA



4122403 ASSIEME

BANDIERINE 2.0 2.5
3.0 300X110mm /
ASSEMBLY FLAGS 2.0
2.5 3.0 300X110mm

K02938:

ARISTARCO SPA



DIMENSIONS
110X300mm

4114692 ASS.
BANDIERINE 21 22 25 /
COMPLETE CURTAIN
ASSY 21 22 25
K00826:
ARISTARCO SPA

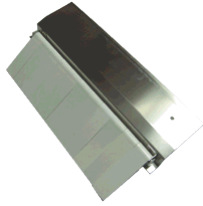

L= 257 mm

4114897 ASS.
BANDIERINE 28 30 /
COMPLETE CURTAIN
ASSY 28 30
K00225:
ARISTARCO SPA

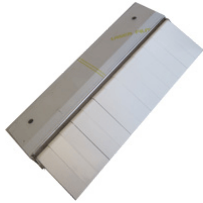

L= 310 mm

4114058 PORTABAN
DIERINE COMPLETO
CB184 /
COMPLETE CURTAIN
ASSY CB184
C22106EX:
BREMA ICE MAKERS
SPA
K10532:
BREMA ICE MAKERS
SPA



L= 180 mm

4114059 PORTABAN
DIERINE COMPLETO
CB246 VT /
COMPLETE CURTAIN
ASSY CB246
K10533:
BREMA ICE MAKERS
SPA
CB246- SL50:
BREMA ICE MAKERS
SPA



L=344mm

4114001 ASSIEME
PORTABANDIERINE
40 /
STANDARD-BEARER
KIT 40
K10534:
BREMA ICE MAKERS
SPA
C22035EX:
BREMA ICE MAKERS
SPA



L=456mm

4114005 ASSIEME
PORTABAND. 60/80
BREMA /
STANDARD-BEARER
KIT 60/80 BREMA
C22059:
BREMA ICE MAKERS
SPA



L=665mm

4114802 ASTA CON
BANDIERINE cb184 TN
/
CURTAIN ASSY CB184
NEW
C10532:
BREMA ICE MAKERS
SPA



L=276mm

4114786 ASTA CON
BANDIERINECB246-
SL50 NT /
ROD WITH
BANDIERINECB246
SL50-NT
CB246-SL50:
BREMA ICE MAKERS
SPA



A=4122088, L=325mm

4122088 Supporto
bandierine /
Support flags
10529:
BREMA ICE MAKERS
SPA



A=4114786

4114886 ASTA CON
BANDIERINE /
CURTAIN ASSY FOR
SL90
SL90:
BREMA ICE MAKERS
SPA



L=446mm

4114894 SUPPORTO
BANDIERINE /
FLAGS SUPPORT
10530:
BREMA ICE MAKERS
SPA



4122271 SUPPORTO
BANDIERINE CB316-
416-425 /
SUPPORT FLAGS
CB316-416-425
N10526: N.T.F. SRL
10526:
BREMA ICE MAKERS
SPA



4114337 ASSIEME
TENDINE N21 A/W /
CURTAIN ASSY N21
A/W
CM81401600/0:
CASTEL MAC SPA
CM81401600/0:
CASTEL MAC SPA



L= 278 mm

4122020 CURTAIN
ASSY /
CURTAIN ASSY
889125142:
GRUPPO CIMBALI
SPA
78317101R:
SIMAG SPA
78317101R:
SCOTSMAN ICE SRL



L=333mm

4114153 ASSIEME
TENDINA S40 /
CURTAIN S40
889125143:
GRUPPO CIMBALI
SPA
SD40: SIMAG SPA
78317200R:
SCOTSMAN ICE SRL



L=415mm

4122077 5008
TENDINA /
CURTAIN ASSY
5008: I.T.V. S.A.



L=382mm

4114430 SUPPORTO
BANDIERINE KL21
COMPLETO /
CURTAIN ASSY KL21
2CD035: MIGEL
S.R.L.



DIMENSIONS
203X670mm

4114573 SUPPORTO
BANDIERINE KL31
COMPLETO /
CURTAIN ASSY KL31
2CD036: MIGEL
S.R.L.

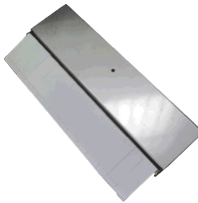

4122269 SUPPORTO
BANDIERINE
KL41/51/61 /
SUPPORT FLAGS KL
41/51/61
2CD037: MIGEL
S.R.L.

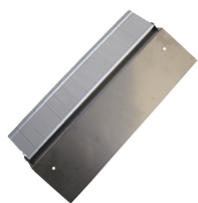

L=400mm

4122086 CURTAIN
ASSY /
CURTAIN ASSY
78416903R:
SCOTSMAN ICE SRL



L=186mm

4114053 PORTABAN
DIERINE COMP. /
COMPLETE CURTAIN
ASSY
AC055:
SCOTSMAN ICE SRL

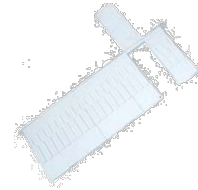

L=283mm

4114555 CURTAIN
ASSY /
CURTAIN ASSY
78425002R:
SCOTSMAN ICE SRL
78445701R:
SCOTSMAN ICE SRL



L= 305 mm

4114089 ASSIEME
PORTABANDIERINE /
CURTAIN ASSY
78416901R:
SCOTSMAN ICE SRL

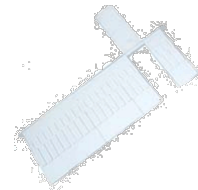

L=325mm

4114554 CURTAIN
ASSY /
CURTAIN ASSY
78445700R:
SCOTSMAN ICE SRL



L=350mm

4114637 CURTAIN
ASSY /
CURTAIN ASSY
78445708R:
SCOTSMAN ICE SRL



L=424mm

4114518 CURTAIN
ASSY /
CURTAIN ASSY
78445704R:
SCOTSMAN ICE SRL



L=460mm

4122392 TENDINA
COMPLETA L=570mm /
CURTAIN ASSY
L570mm
78317203R:
SCOTSMAN ICE SRL



L=570mm

4114645 CURTAIN
ASSY /
CURTAIN ASSY
78445702R:
SCOTSMAN ICE SRL



H= 120 mm, L= 575 /
610mm

4114669 CURTAIN
ASSY /
CURTAIN ASSY
78445709R:
SCOTSMAN ICE SRL



L=600mm

4114822 CURTAIN
ASSY /
CURTAIN ASSY
78445705R:
SCOTSMAN ICE SRL
78445703R:
SCOTSMAN ICE SRL
78416905EX:
SCOTSMAN ICE SRL



L=620mm

4114981 CURTAIN
ASSY-SMALL CUBE /
CURTAIN ASSY-
SMALL CUBE
78445710R:
SCOTSMAN ICE SRL



4114826 CURTAIN
BRACKET KIT /
CURTAIN BRACKET
KIT
06052409:
SCOTSMAN ICE SRL

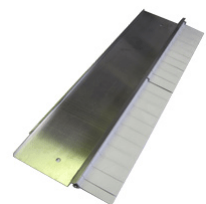

4122434 CURTAIN /
CURTAIN
0200430701:
SCOTSMAN ICE SRL

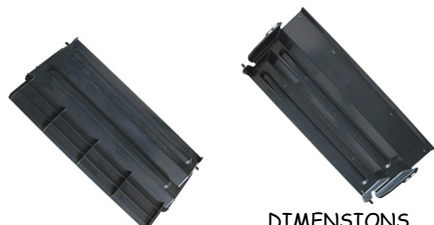

DIMENSIONS
470X217mm

4122298 BANDIERI
NA ABS NSF 23x81 mm
FORO ø 8 mm /
ABS FLAG NSF 23x81
mm HOLE ø 8 mm
K21/5 - K22/5 -
K25/6 ---28/7 -
30/10 - 44/15 -
50/26 - 75/40 -
100/60 ---130/75 -
160/75 :
ARISTARCO SPA



4114075 BANDIERI
NA /
CURTAIN
10005:
BREMA ICE MAKERS
SPA



4122481 606 OUTER
CURTAIN FLAP /
606 OUTER CURTAIN
FLAP
110606: I.T.V. S.A.



4114102 TENDINA
SCOTSMAN /
CURTAIN SCOTSMAN
66062900:
SCOTSMAN ICE SRL



4114496 CURTAIN /
CURTAIN
66030201:
SCOTSMAN ICE SRL



4114093 BRACCIO
TENDINA DX /
RIGHT CURTAIN
BRACKET
66038801:
SCOTSMAN ICE SRL



4114095 BRACCIO
TENDINA SINISTRA /
LEFT CURTAIN
66038800:
SCOTSMAN ICE SRL

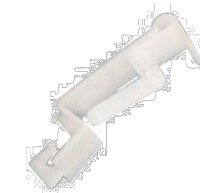

4114816 EVAPORAT
ORE EC30 /
EVAPORATOR EC30
601066:
ARISTARCO SPA
RC00A402:
EURFRIGOR SRL
TR914093:
BRICE ITALIA SRL



4114991 Evaporatore /
EVAPORATOR
D14167:
BREMA ICE MAKERS
SPA



4114442 EVAPORAT
ORE /
EVAPORATOR
D14148:
BREMA ICE MAKERS
SPA



4122108 Evaporatore /
evaporator
D14529:
BREMA ICE MAKERS
SPA



4122057 EVAPORAT
ORE /
EVAPORATOR
CM814016200ex:
CASTEL MAC SPA
CM81410905:
SCOTSMAN ICE SRL



4114259 ASS.EVAPO
RATORE N75/90/100 /
EVAPORATOR
N75/90/100
81422040/0
: ICEMATIC
CM81422040:
SCOTSMAN ICE SRL
CM81422040/0:
CASTEL MAC SPA

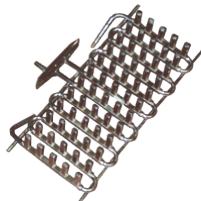

4114288 ASS.EVAPO
RATORE N55 /
EVAPORATOR N55
CM81412031:
SCOTSMAN ICE SRL
CM81412031/0:
CASTEL MAC SPA



4122297 ASSIEME
EVAPORATORE P.38
KP 2.0 /
EVAPORATOR ASSY
P.38 KP 2.0
K03560:
ARISTARCO SPA



DIMENSIONS
330X200 mm

4114160 EVAPORAT
ORE STAGNATO
CUB.A /
EVAPORATOR
D10045:
BREMA ICE MAKERS
SPA
087966:
ELECTROLUX
PROFESSIONAL
S.P.A.

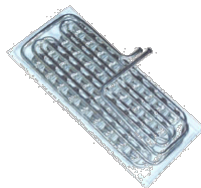

WIDTH= 198 mm,
LENGTH= 325 mm

4114969 Evaporatore
C80 /
evaporator C80
C80:
BREMA ICE MAKERS
SPA



WIDTH= 195 mm,
LENGTH= 780 mm

4114112 EVAPORAT
ORE PER CB184 /
EVAPORATOR FOR
CB184
D10079:
BREMA ICE MAKERS
SPA



DIMENSIONS
180X225mm

4114098 EVAPORAT
ORE X CB/316/416W /
EVAPORATOR X
CB/316/416W
D10046:
BREMA ICE MAKERS
SPA



4114304 EVAPORAT
ORE /
EVAPORATOR
ND10092: N.T.F. SRL
D10092:
BREMA ICE MAKERS
SPA



4114887 EVAPORAT
ORE /
EVAPORATOR
D10381:
BREMA ICE MAKERS
SPA



4114640 EVAPORAT
ORE KL31-KD3 /
EVAPORATOR KL31-
KD3
2VP007: MIGEL S.R.L.



WIDTH= 185 mm,
LENGTH= 355 mm

4114657 EVAPORAT
OR ASSY /
EVAPORATOR ASSY
78429708:
SCOTSMAN ICE SRL



4114764 EVAPORAT
OR ASSY /
EVAPORATOR ASSY
78461501:
SCOTSMAN ICE SRL



4114587 EVAPORAT
OR ASSY /
EVAPORATOR ASSY
78448600ex:
SCOTSMAN ICE SRL
1ZA023:
SCOTSMAN ICE SRL
78470000:
SCOTSMAN ICE SRL



4122460 ASSIEME
EVAPORATORE
L280XP160mm /
EVAPORATOR ASSY
78479000:
SCOTSMAN ICE SRL



P=160mm, L=280mm

4114761 EVAPORAT
OR /
EVAPORATOR
78443502:
SCOTSMAN ICE SRL



4114483 EVAPORAT
OR PLATEN - L - / .
EVAPORATOR
PLATEN - L -
78443402:
SCOTSMAN ICE SRL



4122401 GRUPPO
EVAPORATORE
STAGNATO C35 50 /
EVAPORATOR ASSY
C35 50
9086701100:
STAFF ICE SYSTEM
SRL

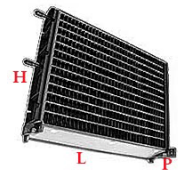

P=195mm, H=55mm,
L=433mm

4114417 EVAPORAT
ORE POSTERIORE /
EVAPORATOR
D10227:
BREMA ICE MAKERS
SPA
ND10227: N.T.F. SRL

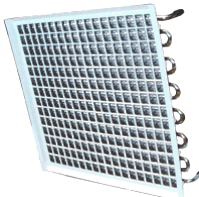

WIDTH= 633 mm,
LENGTH= 550 mm

4122022 EVAPORAT
OR ICE /
EVAPORATOR ICE
CM81454652/0:
CASTEL MAC SPA
CM81454652:
SCOTSMAN ICE SRL

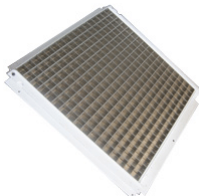

4114865 EVAPORAT
OR /
EVAPORATOR
81453690/0:
ICEMATIC
CM81454167/0:
CASTEL MAC SPA
CM81454498:
SCOTSMAN ICE SRL
CM81453690:
SCOTSMAN ICE SRL
CM81453690/OEX:
CASTEL MAC SPA
CM81454167:
SCOTSMAN ICE SRL



4122028 EVAPORAT
OR HD /
EVAPORATOR HD
CM81453737ex:
SCOTSMAN ICE SRL



4122295 EVAPORAT
ORE COMPLETO /
EVAPORATOR ASSY
IOM205123282:
SCOTSMAN ICE SRL

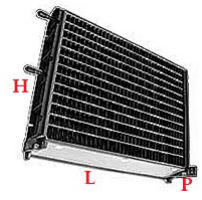

P= 85 mm, H= 380 mm,
L=470mm

4122215 EVAPORAT
ORE T5 /
EVAPORATOR T5
CM19270072/0:
CASTEL MAC SPA



4114840 EVAPORAT
ORE /
EVAPORATOR
082732:
ELECTROLUX
PROFESSIONAL
S.P.A.

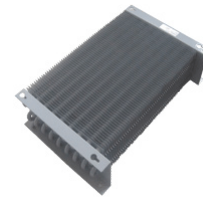

4122376 BATTERIA
EVAPORANTE
410x230x130 mm /
EVAPORATOR 57602
410x230x130 mm
087402:
ELECTROLUX
PROFESSIONAL
S.P.A.

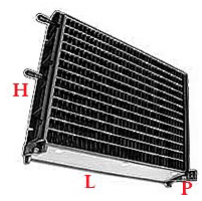

P=129mm, H=225mm,
L=407mm

4122330 "EVAPORATORE; ASSY; 4R-4T"
300x110x100 mm /
EVAPORATOR
300x110x100 mm
091586:
ELECTROLUX
PROFESSIONAL
S.P.A.

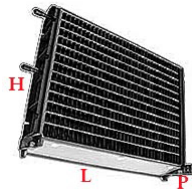
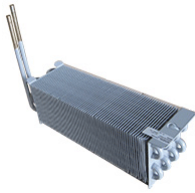

P= 100 mm, H= 115 mm,
L= 350 mm

4114996 BATTERIA
EVAPORANTE AB 1
MODULO /
EVAPORATOR
BATTERY AB 1 FORM
FR995930:
FRIULINOX S.R.L.



4122270 EVAPORATORE
PER TAVOLO
ABBATTITORE /
EVAPORATOR FOR
TABLE BLAST
CHILLER
FR925529 :
FRIULINOX S.R.L.

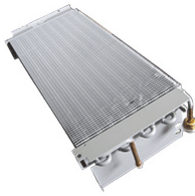

4122305 EVAPORATORE
1-2-3-4P.VENT.
T.REF.GN /
EVAPORATOR FAN 1-
2-3-4P
REFRIGERATED
TABLE GN
RI9302: ILSA SPA

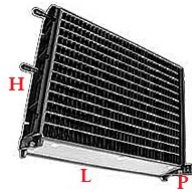

P= 70 mm, H= 290 mm,
L= 490 mm

4122349 EVAPORATORE
TR 1300 9
RANGHI /
EVAPORATOR TR
1300 9 RANKS
MA2581624:
MARENO
INDUSTRIE ALI SPA

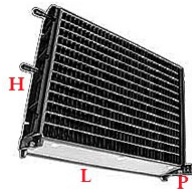

P= 75mm, H= 225mm, L= 510mm

4122073 EVAPORATORE
OR-HALF CUBE /
EVAPORATOR-HALF
CUBE
IOM205114882:
SCOTSMAN ICE SRL

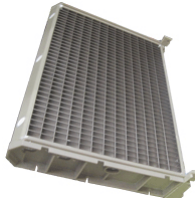

4122397 EVAPORATORE
OR RH /
EVAPORATOR RH
IOM205123882:
SCOTSMAN ICE SRL

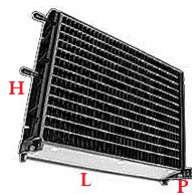
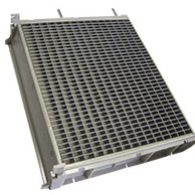

P=84mm, H=416mm,
L=464mm

4122408 EVAPORATORE
OR LH /
EVAPORATOR LH
IOM205123782:
SCOTSMAN ICE SRL

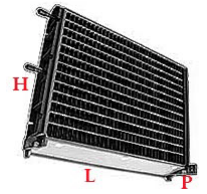
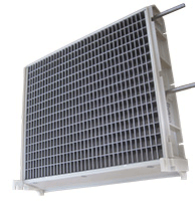

P=84mm, H=408mm,
L=467mm

4114057 EVAPORATORE
COMPLETO
BREMA /
COMPLETE
EVAPORATOR
BREMA
C11095:
BREMA ICE MAKERS
SPA



4114570 EVAPORATORE
COMPLETO /
COMPLETE
EVAPORATOR
C11113:
BREMA ICE MAKERS
SPA



4114571 ASSIEME
TUBO SCARICO
GHIACCIO G500 /
ASSEMBLY DRAIN
TUBE ICE G500
C10460:
BREMA ICE MAKERS
SPA



4114256 KIT
SOSTITUZIONE
EVAPORATORE G500 /
EVAPORATOR KIT
G500
KITNEVG500:
BREMA ICE MAKERS
SPA



4114120 KIT
SOSTITUZIONE EVAP. GB /
EVAPORATOR KIT
GB
KITNEVGB:
BREMA ICE MAKERS
SPA



4114972 RV003432-
EVAPORATORE
COMPLETO ES2-300 (/
RV00C904) /
RV003432-
EVAPORATOR
COMPLETE ES2-300
(RV00C904
AS911002ex:
BRICE ITALIA SRL



4114411 WORM
TUBE /
WORM TUBE

CMCF78426009:
CASTEL MAC SPA
78426009:
SCOTSMAN ICE SRL
78426009:
SIMAG SPA
CF78426009:
ICEMATIC



4114372 FREEZER
ASSY /
FREEZER ASSY

CF79423704:
ICEMATIC
CF79423705:
ICEMATIC
79423704R:
SCOTSMAN ICE SRL
CMCF79423705:
CASTEL MAC SPA
79423706RR:
SCOTSMAN ICE SRL



4114722 WORM
TUBE KIT /
WORM TUBE KIT

78426107/0:
ICEMATIC
78426107EX:
SCOTSMAN ICE SRL
06070502:
SCOTSMAN ICE SRL
CMCF78426103ex:
CASTEL MAC SPA
CMCF78426107ex:
CASTEL MAC SPA
CMCF06070502:
CASTEL MAC SPA



4122257 EVAPORAT
ORE KF180/250 /
EVAPORATOR KF180 /
250

2VP019: MIGEL S.R.L.



4122289 TUBO
EVAPORATORE
KF180/250 /
TUBE EVAPORATOR
KF180 / 250

2VP024: MIGEL S.R.L.



4122280 WORM
TUBE AND SPOUT KIT
/
WORM TUBE AND
SPOUT KIT

06070502R:
SCOTSMAN ICE SRL



4122227 WORM
TUBE /
WORM TUBE

78454101:
SCOTSMAN ICE SRL



4122092 *GR
EVAP.COMPL.SB230-
SG230 PLAST S.2/S230
BOCCA POLIST. /
EVAPORATOR UNIT
COMPLETE SB 230-
SG230 PLAST S.2/S230
SPOUT POLYSTYRE

9086692300:
STAFF ICE SYSTEM
SRL



4122293 BASE
EVAPORATORE /
BASIC EVAPORATOR
9050360000:
STAFF ICE SYSTEM
SRL

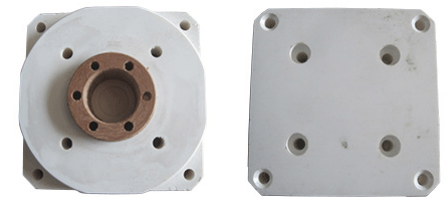

4114181 COCLEA+C
USCINETTO
INOX+ANELLO RID.+
GIUNTO /
SCREW WITHOUT
ENDINGS

C20783:
BREMA ICE MAKERS
SPA



4114247 COCLEA
GB /
AUGER GB

20783:
BREMA ICE MAKERS
SPA



4114403 COCLEA /
AUGER

20439:
BREMA ICE MAKERS
SPA



4114870 RV003441-
VITE SENZA FINE X
EVAP. ES 100 /
AUGER ES100

RV003441:
EURFRIGOR SRL
923051:
BRICE ITALIA SRL



4114910 VITE
SENZA FINE X
EVAPORATORE
ES50/70 ECS50 /
WORM SCREW X
EVAPORATOR ES50/70
ECS50

RV003440:

EURFRIGOR SRL

923053:

BRICE ITALIA SRL



4114590 COCLEA

KF75 /
AUGER KF75

1VP001: MIGEL S.R.L.



4114455 COCLEA

AF 30 /
AUGER AF 30

72405206:

SCOTSMAN ICE SRL



4114456 COCLEA /
AUGER

72419803:

SCOTSMAN ICE SRL



4122319 AUGER /
AUGER

CM251310010:

CASTEL MAC SPA

CM25131001:

SCOTSMAN ICE SRL



4114379 COCLEA
CON VITE /
WORM

C20658:

BREMA ICE MAKERS
SPA



4114277 ROMPIGHI
ACCIO /
ICEBREAKER

20683:

BREMA ICE MAKERS
SPA



4114797 ROMPIGHI
ACCIO /
ICEBREAKER

20915:

BREMA ICE MAKERS
SPA



4122277 RV00C902-
ROMPIGHIACCIO X
ES200/320 NEW /
RV00C902-
ICEBREAKER X ES200
/ 320 NEW

920023:

BRICE ITALIA SRL



4114189 ROMPIGHI
ACCIO

C/CUSCINETTO /
TOP BEARING
SCOTSMAN

67004100ex:

SCOTSMAN ICE SRL

CMCF67004100ex:

CASTEL MAC SPA

06072000:

SCOTSMAN ICE SRL



4114457 ROMPIGHI
ACCIO /
ICE BREAKER ONLY

75100501:

SCOTSMAN ICE SRL

CMCF75100501:

CASTEL MAC SPA



4114062 SEMI
GIUNTO D. 50/19,5 /
SEMI-JOINT D.50/19,5

D20430:

BREMA ICE MAKERS
SPA



4114923 Semi giunto
inferiore /
Semi bottom joint

D20493:

BREMA ICE MAKERS
SPA

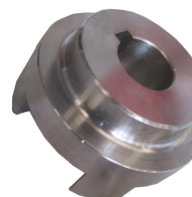

4114863 SEMI
GIUNTO SUPERIORE /
SEEDS JOINT TOP

D20642:

BREMA ICE MAKERS
SPA

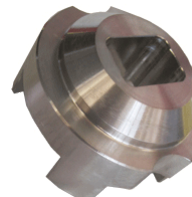

4122080 Semi giunto
superiore /
Half upper joint
D20654:
BREMA ICE MAKERS
SPA

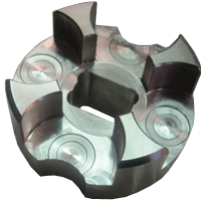

4114251 GIUNTO /
COUPLING
D20784:
BREMA ICE MAKERS
SPA



4114505 COUPLING
/
COUPLING
65054300:
SCOTSMAN ICE SRL

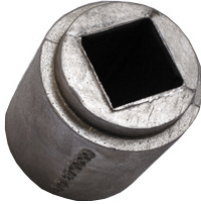

4114121 FLANGIA /
FLANGE
20629:
BREMA ICE MAKERS
SPA



4114230 KIT
COUPLING MF /
KIT COUPLING MF
06035901:
ICEMATIC
06035901:
SCOTSMAN ICE SRL
CM06035901:
CASTEL MAC SPA



4114131 ASSIEME
GIUNTO /
COUPLING
I06035900:
GIGA GRANDI
CUCINE SRL
06035900:
SCOTSMAN ICE SRL
CMCF06035900:
CASTEL MAC SPA



4122109 MINUTERI
A EVAPORATORE
KF500 /
SMALL PARTS
EVAPORATOR KF500
ACCKF500:
MIGEL S.R.L.



4114301 KIT
BEARING + SEAL MF /
KIT BEARING + SEAL
MF
00102808:
SCOTSMAN ICE SRL
CF00102808:
ICEMATIC
CMCF06069201:
CASTEL MAC SPA
CMCF00102808ex:
CASTEL MAC SPA
06069201:
SCOTSMAN ICE SRL

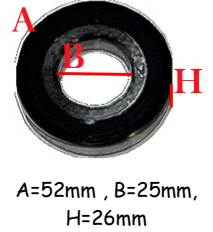

4114591 CUSCINET
TO A RULLI KS270-
KS550 /
BUSH KS 270-KS550
KS270-KS550:
ARISTARCO SPA



4122429 CUSCINET
TO 6904 H 2RS /
BEARING 6904 H 2RS
20531:
BREMA ICE MAKERS
SPA
EU20531:
BRICE ITALIA SRL
N20531: N.T.F. SRL

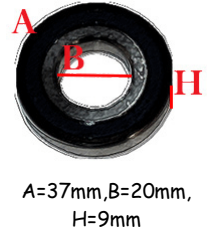

4114249 CUSCINET
TO INOX /
BEARING STEEL
20782:
BREMA ICE MAKERS
SPA

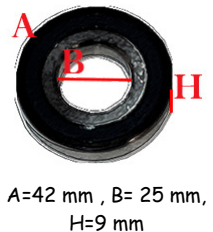

4114254 CUSCINET
TO INOX SUPERIORE /
UPPER STAINLESS
STEEL BEARING
20433:
BREMA ICE MAKERS
SPA

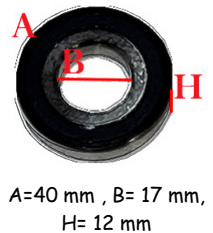

4122170 Cuscinetto
inox /
bearing steel
20917:
BREMA ICE MAKERS
SPA

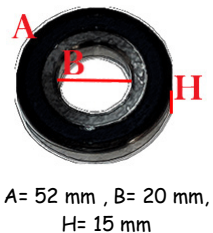
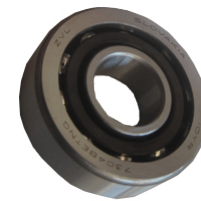

4114234 CUSCINET
TO INOX G250 /
STEINLESS STEEL
BEARING G250
20112: BREMA ICE
MAKERS SPA

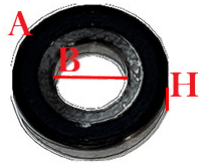

A= 52 mm , B= 25 mm,
H= 15 mm

4114244 CUSCINET
TO REGGISPINTA /
THRUST BEARING
20686:
BREMA ICE MAKERS
SPA
20623:
BREMA ICE MAKERS
SPA

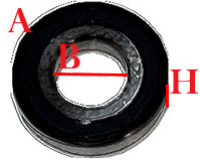

A= 40 mm, B= 19 mm,
H= 24 mm

4114130 CUSCINET
TO SUPERIORE /
UPPER BEARING
CM65105600:
CASTEL MAC SPA
65105600:
SCOTSMAN ICE SRL
CM29015006/0:
CASTEL MAC SPA

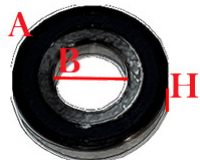

A= 32 mm , B= 12 mm,
H= 10 mm

4114028 CUSCINET
TO INFERIORE /
LOW BEARING
CMCF67001101:
CASTEL MAC SPA
67001101:
SCOTSMAN ICE SRL

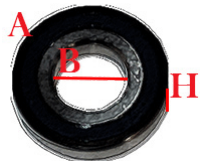

A= 47 mm, B= 22 mm,
H= 12 mm

4122049 CUSCINET
TO A RULLI SF /
ROLLER BEARING SF
CMCF02168000:
CASTEL MAC SPA



4114824 CUSCINET
TO 6004 2RS
XES50/70/100/200/320 /
BEARING FOR
ES50/70/100/200/320
RV003324:
EURFRIGOR SRL
923020:
BRICE ITALIA SRL

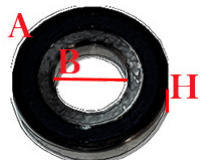

A= 42 mm , B= 20 mm,
H= 12 mm

4122275 RV00C906-
CUSCINETTO OBL. A
SFERE 2 COR. 3 /
RV00C906-BEARING
BALL 2 COR. 3
923059:
BRICE ITALIA SRL

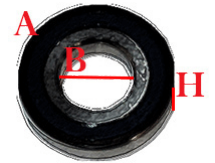

A= 52 mm , B= 25 mm,
H= 20,5 mm

4114873 RV003319-
CUSCINETTO 6202
2RSH X EVAP. ES
50/70/100 /
RV003319-BEARING
6202 2RSH X EVAP. ES
50/70/100
RV003319:
EURFRIGOR SRL
923021:
BRICE ITALIA SRL



4114333 CUSCINET
TO 626 2RS N
ACC.CARB.CUBETTO /
BEARING 626 2RS
923023:
BRICE ITALIA SRL
RV003647:
EURFRIGOR ICE
MAKERS SRL
RV003647:
EURFRIGOR SRL



4122288 MASSELLO
PER GUARNIZIONE
KF165/250 COMPLETO
/
SOLID FOR SEAL
KF165 / 250
COMPLETE
2VPO52: MIGEL S.R.L.

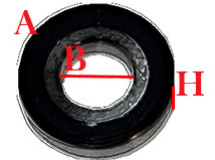

A= 52 mm , B= 25 mm,
H= 15 mm

4114562 MASSELLO
PER GUARNIZIONI
KF75/125 /
GASKET LUMP
KF75/125
2VPO48: MIGEL S.R.L.



4114225 CUSCINET
TO /
BEARING
0200168000:
SCOTSMAN ICE SRL

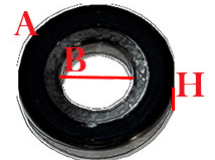

A=39mm, B=25mm,
H=2mm

4114841 BEARING /
BEARING
65105300:
SCOTSMAN ICE SRL

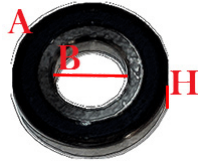

A=40mm , B=17mm,
H=12mm

4114420 BEARING /
BEARING
65105800:
SIMAG SPA
65105800:
SCOTSMAN ICE SRL
CMCF65105800:
CASTEL MAC SPA

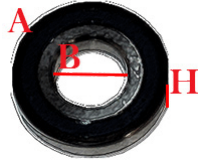

A=52mm,B=25mm,
H=26mm

4114227 KIT
CUSCINETTO +
PORTACUSCINETTO+
SUPPORTO /
BEARING+ RETAINER
KIT
CMCF06068800:
CASTEL MAC SPA
75400801 :
SCOTSMAN ICE SRL
65105900EX:
ICEMATIC
06052700EX:
SCOTSMAN ICE SRL
CM65105900EX:
CASTEL MAC SPA
06068800:
SCOTSMAN ICE SRL

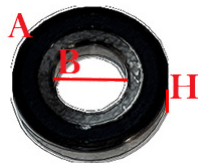

A= 62 mm , B= 30 mm,
H= 18 mm

4114860 CORTECO
DPSM 27-37-7 X
EVAP.ES 200/320 /
CORTECO DPSM 27-
37-7 X EVAP.ES
200/320
RV003314:
EURFRIGOR SRL
913008:
BRICE ITALIA SRL

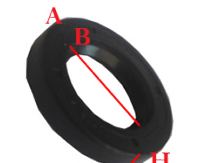

A=37mm,B=28mm,
H=7 mm

4114823 CORTECO
DPSM 20-30-7 /
CORTECO DPSM 20-
30-7
RV003316:
EURFRIGOR SRL
913006:
BRICE ITALIA SRL



A= 30 mm, B= 20 mm,
H= 7 mm

4114347 ANELLO
CORTECO /
RING
20656:
BREMA ICE MAKERS
SPA



A= 42 mm, B= 30 mm,
H= 7 mm

4114862 ANELLO
CORTECO 20985 /
RING CORTECO 20985
20985:
BREMA ICE MAKERS
SPA



4114393 ANELLO
CORTECO /
RING CORTECO
20682:
BREMA ICE MAKERS
SPA



4122276 RV00C907-
CORTECO 25-37-7 X
EVAPORATORE
ES200/3 /
RV00C907-CORTECO
25-37-7 X
EVAPORATOR ES200/3
913058:
BRICE ITALIA SRL



A= 37 mm, B= 24 mm,
H= 7 mm

4114867 RV003315-
CORTECO DPSM 18-
28-7 /
RV003315-CORTECO
DPSM 18-28-7
913005:
BRICE ITALIA SRL



4114868 RV003312-
CORTECO DPSM 22-
32-7 X ES 50/70/100 /
RV003312-CORTECO
DPSM 22-32-7 X ES
50/70/100
RV003312:
EURFRIGOR SRL
913007:
BRICE ITALIA SRL



4114839 DISTANZIA
LE ABS 5015/4/4 /
SPACER ABS 5015/4/4
RH001168:
EURFRIGOR SRL
910047:
BRICE ITALIA SRL
RH001168:
EURFRIGOR ICE
MAKERS SRL



4114872 RV003311-
CORTECO DPSM 15-
24-7 X ES 50/70/100 /
RV003311 CORTECO
DPSM 15-24-7 X-ES
50/70/100
RV003311:
EURFRIGOR SRL
913004:
BRICE ITALIA SRL



4122047 PARAOLIO
SF300-500 MOTOR. (EX
29000013/0) /
OIL SEAL SF300-500
CMCF02160600:
CASTEL MAC SPA

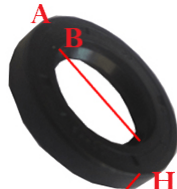

A= 25 mm , B= 15 mm,
H= 6 mm

4122195 INSERTO
IN GOMMA /
RUBBER INSERT
CMCF64009501:
CASTEL MAC SPA
64009501:
SCOTSMAN ICE SRL



4114310 PARAOLIO
F100-120-200 /
GREASE SEAL F100-
120-200
64008300:
SCOTSMAN ICE SRL
CMCF64008300:
CASTEL MAC SPA



A= 18 mm, B= 13 mm,
H= 4,6 mm

4114044 PARAOLIO
CASTELMAC /
GREASE SEAL
CASTELMAC
64001901:
SCOTSMAN ICE SRL
CMCF64001901:
CASTEL MAC SPA
I64001901:
GIGA GRANDI
CUCINE SRL
CMCF02160700:
CASTEL MAC SPA

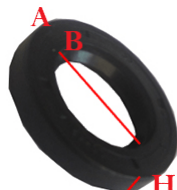

A= 32 mm , B= 21 mm,
H= 5 mm

4114842 OIL SEAL /
OIL SEAL
0200160600:
SCOTSMAN ICE SRL

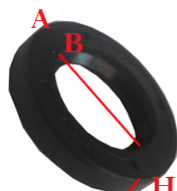

A=25mm ,B=14mm,
H=6mm

4122282 GUARNIZI
ONE /
SEAL
0A03237929:
SCOTSMAN ICE SRL



4122446 WATER
SHED /
WATER SHED
1300087101:
SCOTSMAN ICE SRL



DIMENSIONS
47X19X6mm

4122050 ANELLO
TENUTA SF300-500 /
RING SEAL SF300-500
CMCF02285301:
CASTEL MAC SPA

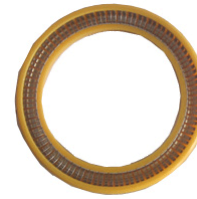

A= 34 mm B= 26 mm,
H= 5 mm

4114224 OIL SEAL /
OIL SEAL
02285301:
ICEMATIC
CM02285301:
CASTEL MAC SPA
0200285301:
SCOTSMAN ICE SRL

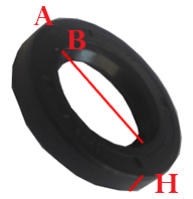

A= 34 mm , B= 25 mm,
H= 5mm

4122220 WATER
SEAL /
WATER SEAL
0200092923:
SCOTSMAN ICE SRL



4114190 ANELLO
PREMISTOPPA /
WATER SEAL
64004000:
SCOTSMAN ICE SRL
CMCF64004000:
CASTEL MAC SPA



4114216 GEAR /
GEAR
65115700:
SCOTSMAN ICE SRL
CMCF65115700:
CASTEL MAC SPA
CF65115700:
ICEMATIC



4114318 INGRANAG
GIO INTERM. M/RID. 2

GEAR AND PINION

CMCF65116100:

CASTEL MAC SPA

CF65116100:

ICEMATIC

65116100:

SCOTSMAN ICE SRL



4114321 INGRANAG
GIO FIN. F100-F120 /
GEAR & PINION F100-
F120

CMCF65116201:

CASTEL MAC SPA

CF65116201:

ICEMATIC

65116201:

SCOTSMAN ICE SRL



4114221 GEAR /
GEAR

CF65115800:

ICEMATIC

65115800:

SCOTSMAN ICE SRL

CMCF65115800:

CASTEL MAC SPA



4114214 GEAR /
GEAR

65115600:

SCOTSMAN ICE SRL

CMCF65115600:

CASTEL MAC SPA



4114315 INGRANAG
G.IN FIBRA F100/
120/200 /
FIRST GEAR PINION
FOR F100/120/200

65116000:

SCOTSMAN ICE SRL

CF65116000:

ICEMATIC



4114398 KIT
RAMPA SCIVOLO
SCIVOLO CUBETTI
184-35 /
GRID

10136*:

BREMA ICE MAKERS

SPA

N10136*: N.T.F. SRL

K10626:

BREMA ICE MAKERS

NK10626: N.T.F. SRL



4114176 SCIVOLO
CUB. TRATTATO VM-
VB /
SLIDES CUBE

D12057:

BREMA ICE MAKERS

SPA



DIMENSIONS

150x454mm

4122051 Scivolo
cubetti /
slide cubes

D12031:

BREMA ICE MAKERS

SPA



DIMENSIONS

185x665 mm

4114330 SCIVOLO
CUBETTI /
GRID

D12017:

BREMA ICE MAKERS

SPA



DIMENSIONS

203X670mm

4114194 SCIVOLO
CUBETTI /
CHUTE CUBES

D12001:

BREMA ICE MAKERS

SPA



DIMENSIONS

205x325mm

4122359 SCIVOLO
CUBETTI TRATTATO
CUB. 'D' /
CHUTE CUBE CUB. 'D'

D12046:

BREMA ICE MAKERS

SPA



DIMENSIONS

208x325mm

4122463 SCIVOLO
CUBETTI TRATTATO
CUB. 'C-E' /
CHUTE CUBES 'C-E'

D12030:

BREMA ICE MAKERS

SPA



DIMENSIONS

210X435mm

4114143 SCIVOLO
CUB. TRATTATO CUB.
C /
GRILL FOR ICE
MAKERS C

D12033:

BREMA ICE MAKERS



4137001 GRIGLIA
CUBETTI 30/40 KG. /
GRILL FOR ICE
MAKERS 30/40KG

D12008:

BREMA ICE MAKERS

SPA



4137110 SCIVOLO
INTERNO BACINELLO
TRATTATO /
INTERNAL CHUTE
BASIN

D12043:

**BREMA ICE MAKERS
SPA**



DIMENSIONS
282X135mm, H=70mm

4137113 SCIVOLO
INTERNO
BACININELLA
TRATTATO /
INTERNAL CHUTE
BASIN

D12048:

**BREMA ICE MAKERS
SPA**



4137084 SCIVOLO
CUBETTI /
CHUTE

D12078:

**BREMA ICE MAKERS
SPA**



4114760 CONTROB
ACINELLA N EC 20
COMP. /
CHUTE FOR BASIN N
EC20

RN00A016:

**EURFRIGOR SRL
923019:
BRICE ITALIA SRL**

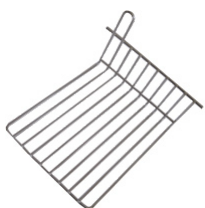

DIMENSIONS
127X160X60mm

4122302 RN00A018-
CONTRO-BACINELLA
EC 40/50 NEW
233x162x62 mm /
RN00A018-CHUTE
FOR BASIN EC 40/50
NEW 233x162x62 mm

923018:

BRICE ITALIA SRL



DIMENSIONS
160x235 mm

4114794 CONTROB
ACINELLA EC 20/30
NEW /
SLIDE GRATE EC
20/30 NEW

RN00A017:

**EURFRIGOR SRL
923014: BRICE**



4114893 RN000932-
SCIVOLO CUBETTI EC
30/40 /
CHUTE EC30/40

912003:

**BRICE ITALIA SRL
RN000932:
EURFRIGOR SRL**



4137077 GRIGLIA
CONVOGLIATRICE EC
20 340mm x150mm /
CHUTE FOR EC20

912001:

**BRICE ITALIA SRL
RN000931:
EURFRIGOR SRL**



DIMENSIONS
340mm x150mm

4122245 RN00A139-
SCIVOLO CUBETTI EC
130 N /
RN00A139-CHUTE
CUBES EC 130 N

EC130:

BRICE ITALIA SRL



L=860mm

4137107 RN000928-
SCIVOLO CUBETTI
EC-60 /
RN000928-SLIDE
CUBES EC-60

912004:

BRICE ITALIA SRL



4114808 GRIGLIA
POSTER.EC30/40/50S
ES50 ECP32/42 /
BACK GRID FOR
EC30/40/50S ES50
ECP32/42

RN00B417:

**EURFRIGOR SRL
912012:
BRICE ITALIA SRL**



4137074 GRIGLIA
SCORRIMENTO
CUBETTI /
GRID SLIDE CUBES

CMNM65068800:

**CASTEL MAC SPA
65068800:
SCOTSMAN ICE SRL**



4137029 ASSIEME
CONVOGLIATORE
CUBETTI N20 /
CUBES CONVEYER
SET N20

CM81403045:

**CASTEL MAC SPA
CM81403045:
SCOTSMAN ICE SRL**



4137005 ASSIEME
CONV. CUBETTI N30 /
GRILL FOR ICE
MAKERS N30

CM81403025/0:

**CASTEL MAC SPA
CM81403025:
SCOTSMAN ICE SRL**



4114134 ASS.
CONVOGLIATORE
CUBETTI N5 /
GRILL FOR ICE
MAKERS N5

CM81413031/0:
CASTEL MAC SPA
CM81413031:
SCOTSMAN ICE SRL

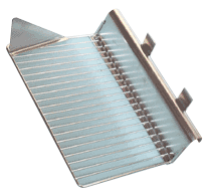

DIMENSIONS
167X255mm

4122416 GRIGLIA
CADUTA CUBETTI
578X232mm /
ICE CHUTE -
578X232mm

65069000:
SCOTSMAN ICE SRL



DIMENSIONS
578X232mm

4114090 ASS.
CONVOGLIATORE
CUBETTI N75 /
CUBES CONVEYER
SET N75

CM81423063/0:
CASTEL MAC SPA
CM81423063:
SCOTSMAN ICE SRL
CM81423063/0:
CASTEL MAC SPA



DIMENSIONS
167X436mm

4137024 GRIGLIA
SCORRIMENTO
CUBETTI 945X231mm /
GRID SLIDE CUBES
945X231mm

Z1AC005:
SCOTSMAN ICE SRL



DIMENSIONS
945X231mm

4122013 CHUTE /
CHUTE

CMX665068401:
CASTEL MAC SPA
65068401:
SCOTSMAN ICE SRL



DIMENSIONS
200X577mm

4122423 ICE CHUTE
/

ICE CHUTE
65069002:
SCOTSMAN ICE SRL



DIMENSIONS
950X232mm

4137119 SCIVOLO
CUBETTI KL41/51 /
CHUTE CUBES KL
41/51

1CD010: MIGEL S.R.L.



DIMENSIONS
393x220mm

4122194 SCIVOLO
CUBETTI /
ICE CHUTE

65074101:
SCOTSMAN ICE SRL



4137108 SCIVOLO
CUBETTI KL18/21 /
SLIDE CUBES KL18 /
21

1CD008: MIGEL S.R.L.



DIMENSIONS
250X165mm

4114376 GRIGLIA /
GRID

65122700:
SCOTSMAN ICE SRL
Z1AC004:
SCOTSMAN ICE SRL



4122141 ICE CHUTE
/

ICE CHUTE
65069001:
SCOTSMAN ICE SRL



4122420 SCIVOLO
CUBETTI KL131:301 /
ICE CHUTE KL131:301

1CD012:
MIGEL S.R.L.



DIMENSIONS
890X234mm

4137057 GRIGLIA
SCORRIMENTO
CUBETTI /
CHUTE

65070700:
SIMAG SPA
65070700:
SCOTSMAN ICE SRL
889125091:
GRUPPO CIMBALI



4122382 SCIVOLA
CADUTA CUBETTI
290X200mm /
ICE DEFLECTOR
290X200mm

65085900:
SCOTSMAN ICE SRL



DIMENSIONS
200X290mm

4114179 GRIGLIA
CADUTA CUBETTI /
GRID

Z1AC050:
SIMAG SPA
65070500: SIMAG
889125090:
GRUPPO CIMBALI



4122451 RACCORD
O
ASPIRAZIONE/MAND
ATA POMPA ISOLATO
/
SUCTION/LOT
CONNECTION PUMP
ISOLATED

C10653:
BREMA ICE MAKERS
SPA



4122378 KIT
RETROFIT UGELLO
ACQUA /
WATER NOZZLE
RETROFIT KIT

06074200:
SCOTSMAN ICE SRL



4114659 WATER
PUMP FITTING /
WATER PUMP
FITTING

Z1AC029:
SCOTSMAN ICE SRL



4114366 SPOUT
INSULATION /
SPOUT INSULATION

CF66013300EX:
ICEMATIC
CF66013200:
ICEMATIC
CF06055100:
ICEMATIC
CMCF65088700:
CASTEL MAC SPA
65088700:
SCOTSMAN ICE SRL



4114479 KIT
INSULATION,
FREEZER /
KIT INSULATION,
FREEZER

CF06055105:
ICEMATIC
06055105:
SCOTSMAN ICE SRL
CMCF06055105:
CASTEL MAC SPA



4114367 KIT
ISOL.TUBO EVAP.
F200 /
KIT INSULATION,
FREEZER F200

CF66037601EX:
ICEMATIC
CF66037600EX:
ICEMATIC
CF06055104:
ICEMATIC
06055104:
SCOTSMAN ICE SRL
CMCF06055104:
CASTEL MAC SPA



4122325 KIT
INSOLANTE PER
EVAPORATORE /
KIT INSULATION
FREEZER

CMCF06055106:
CASTEL MAC SPA
06055106:
SCOTSMAN ICE SRL



4122469 KIT
INSULATION,
FREEZER /
KIT INSULATION,
FREEZER

06055103:
SCOTSMAN ICE SRL
CMCF06055103:
CASTEL MAC SPA

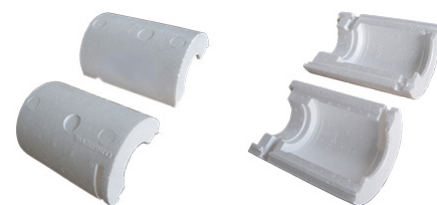

4114533 KIT
INSULATION, SPOUT /
KIT INSULATION,
SPOUT

06055101:
SCOTSMAN ICE SRL



4114535 TEFLON
ICE CHUTE /
TEFLON ICE CHUTE

74112000:
SCOTSMAN ICE SRL



4122193 INSULATIO
N/
INSULATION

65121900:
SCOTSMAN ICE SRL



4122262 STORAGE
BIN /
STORAGE BIN
0A03611820:
SCOTSMAN ICE SRL



4122243 RIGHT TOP
CUP /
RIGHT TOP CUP
66088402:
SCOTSMAN ICE SRL



4122244 LEFT TOP
CUP /
LEFT TOP CUP
66088403:
SCOTSMAN ICE SRL



4122166 FRONT
PANEL /
FRONT PANEL
66081201:
SCOTSMAN ICE SRL



4122317 SUPPORTO
ANELLO /
FLANGE FOR MOTOR
SHAFT
36E3160:
ANGELO PO GRANDI
CUCINE SPA



4122199 RH00A625-
FERMO BACINELLA
EC 130 /
RH00A625-EC 130
DETENTION BASIN
910053:
BRICE ITALIA SRL



4114428 TAPPO
INFERIORE EVAP. ES
200/320 /
LOWER
EVAPORATOR PLUG
RV003449:
EURFRIGOR SRL
601080:
ARISTARCO SPA
910090:
BRICE ITALIA SRL
RV003449:
EURFRIGOR ICE
MAKERS SRL



4122190 INNER BIN
BOTTOM /
INNER BIN BOTTOM
0A03265701:
SCOTSMAN ICE SRL



4114574 FLANGIA /
FLANGE
20644:
BREMA ICE MAKERS
SPA

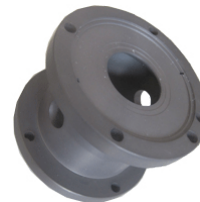

4122433 FLANGIA /
FLANGE
20916:
BREMA ICE MAKERS
SPA



4122038 Anello
rotante completo /
Rotating ring complete
C10193:
BREMA ICE MAKERS
SPA



4114681 ANELLO
ROTANTE COMPLETO
/
COMPLETE
ROTATING RING
C10180:
BREMA ICE MAKERS
SPA



4114541 FREEZER
BRACKET / FREEZER
BRACKET
76401000:
SCOTSMAN ICE SRL

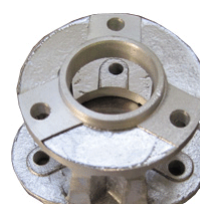

4122452 ALUMINU
M ADAPTER /
ALUMINUM
ADAPTER
76400701:
SCOTSMAN ICE SRL



4114626 LEG / LEG
65056200:
SCOTSMAN ICE SRL



4114348 ANELLO DI
RIDUZIONE /
RING
20659:
BREMA ICE MAKERS
SPA

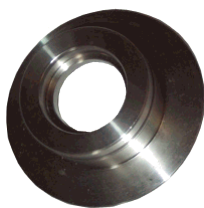

4114608 ANELLO DI
FERMO ALBERO /
RETAINING RING
SHAFT
20227:
BREMA ICE MAKERS
SPA



4114845 SPACER
RING /
SPACER RING
72430800:
SCOTSMAN ICE SRL



4114292 BUSHING /
BUSHING
65106001:
SCOTSMAN ICE SRL



4114294 BUSHING /
BUSHING
65106002:
SCOTSMAN ICE SRL



4122192 RING
HOUSING /
RING HOUSING
72430700:
SCOTSMAN ICE SRL



4114780 CORONA
DENTATA /
CROWN
20363:
BREMA ICE MAKERS
SPA

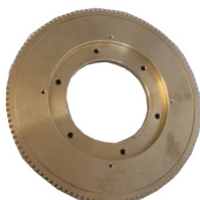

4122327 BOCCOLA
SUPPORTO PORTE
BASI ϕ 10/13 mm /
BUSHING UPPER ϕ
10/13 mm
3044110:
ANGELO PO GRANDI



CUCINE SPA

4122114 RH003638-
ROTELLA X PORTA
EC 14 (IN NYLON) /
RH003638 X-WHEEL
DOOR EC 14 (NYLON)
910079:
BRICE ITALIA SRL



4122115 RQ003639-
BUSSOLA ROTELLA
PORTA D.6 X 9,5 EC 14
/
RQ003639 COMPASS-
WHEEL DOOR D.6 9.5
X 14 EC
920006:
BRICE ITALIA SRL



4122188 BEARING /
BEARING
0200332701:
SCOTSMAN ICE SRL



4122337 BUSSOLA
PER CERNIERA /
HINGE BUSHING
0200238001:
SIMAG SPA
BH550:
SCOTSMAN ICE SRL



4114186 BUSSOLE
DI SCORRIMENTO /
BUSH
66028600:
SCOTSMAN ICE SRL



4114009 BUSSOLA
X ALBERO PAL. IX303
D=12X8 /
PADDLE SHAFT BUSH
IX303 D=12X8
CM25110914:
SCOTSMAN ICE SRL
CM25110914/0:
CASTEL MAC SPA
CM19800179/0:
CASTEL MAC SPA
CM25030019/0:
CASTEL MAC SPA



LENGTH= 20 mm,
DIAMETER= 6 mm

4114015 BUSSOLA
SCORRIMENTO LEVA
NIKE /
NIKE LEVER SLIDING
BUSH
CM25110911:
SCOTSMAN ICE SRL
CM25110911/0:



4114019 BUSSOLA
FISSAGGIO LEVA X
PORTA /
BUSH DOOR LEVER
CM25110114/0:
CASTEL MAC SPA



4114042 RONDELLA
LEVA
RIBALTAMENTO /
OVERTURN LEVER
WASHER
CM25654016:
SCOTSMAN ICE SRL
CM25654016/0:
CASTEL MAC SPA



4114274 DISCHETT
O DI
SPESSORAMENTO /
DISK
22829:
BREMA ICE MAKERS
SPA



4114275 DISCHETT
O
AUTOLUBRIFICANTE
/
DISK AUTOLUBE
20639:
BREMA ICE MAKERS
SPA



4114316 RONDELLA
DI RASAMENTO /
WASHER
CF44180005:
ICEMATIC
44180005:
SCOTSMAN ICE SRL
CMCF44180005:
CASTEL MAC SPA



4114317 RONDELLA
DI RASAMENTO /
WASHER
CF44180006:
ICEMATIC
44180006:
SCOTSMAN ICE SRL
CMCF44180006:
CASTEL MAC SPA



4114319 RONDELLA
DI RASAMENTO /
WASHER
CF44180008:
ICEMATIC
44180008:
SCOTSMAN ICE SRL
CMCF44180008:
CASTEL MAC SPA



4114320 RONDELLA
DI RASAMENTO /
WASHER
44180007:
SCOTSMAN ICE SRL
CF44180007:
ICEMATIC
CMCF44180007:
CASTEL MAC SPA



4114322 WASHER
(441803 00) / WASHER
(441803 00)
0300140804:
SCOTSMAN ICE SRL



4114323 WASHER /
WASHER
CF44180800:
ICEMATIC
44180800:
SCOTSMAN ICE SRL
CMCF44180800:
CASTEL MAC SPA



4114846 WASHER /
WASHER
72425601:
SCOTSMAN ICE SRL



4114848 WASHER /
WASHER
65106100:
SCOTSMAN ICE SRL

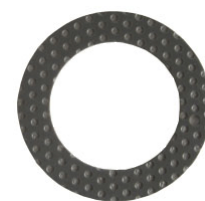

4114849 SPACER /
SPACER
72425700:
SCOTSMAN ICE SRL



4114898 FIBER
WASHER /
FIBER WASHER
Z1AC014:
SCOTSMAN ICE SRL

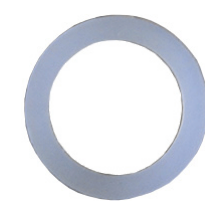

32X23,8X2mm

4114215 RONDELLA
DI RASAMENTO
22x13x0,7 mm /
WASHER 22x13x0,7
mm

0300140824:

SCOTSMAN ICE SRL



22X13X1mm

4114938 WASHER /
WASHER

40003100:

SCOTSMAN ICE SRL



4114611 ANGOLAR
E PER GUARNIZIONE /
GASKET ANGULAR



4122184 RIGHT
SIDE GUIDE /
RIGHT SIDE GUIDE

CMNX66080100:

CASTEL MAC SPA

66080100:

SCOTSMAN ICE SRL



4122185 LEFT SIDE
GUIDE /
LEFT SIDE GUIDE

CMNX66080101:

CASTEL MAC SPA

66080101:

SCOTSMAN ICE SRL



4122075 GUIDA
PORTA
SINISTRA/DESTRA /
GUIDE DOOR LEFT /
RIGHT

4273: I.T.V. S.A.



8111110 1 701 LEFT
DOOR GUIDE Q20-30 /
1 701
LEFT DOOR GUIDE
Q20-30

606026:

ARISTARCO SPA

1701: I.T.V. S.A.

201701: I.T.V. S.A.



4114184 GUIDA
SPORTELLO DX /
DOOR GUIDES
MOUNTING POSITION
RIGHT

66052300:

SCOTSMAN ICE SRL



4114185 GUIDA
SPORTELLO SX /
DOOR GUIDES
MOUNTING POSITION
LEFT

66052301

: SCOTSMAN ICE

SRL



4114649 TENUTA
CERAMICA /
SEAL CERAMIC

20937:

BREMA ICE MAKERS

SPA



4114228 PREMISTO
PPA /
WATER SEAL

65040200:

SCOTSMAN ICE SRL

CMCF65040200:

CASTEL MAC SPA



4114239 KIT
ORGANO DI TENUTA
COMPL. /

KIT SEAL MECH. &
GASKET

00102805:

SCOTSMAN ICE SRL



4114880 RV003202-
PULEGGIA FINITA
DENT. X MOT
ES50'20XL037' /
PULLEY FOR ES50

RV003202:

EURFRIGOR SRL

924005:BRICE



4122234 PULEGGIA
- PD16XL037F /
PULLEY -
PD16XL037F

1TR008: MIGEL S.R.L.



4122125 PULEGGIA
- A60 /
PULLEY - A60

1TR013: MIGEL S.R.L.



4122332 PULLEGGI
A 83 /
PULLEY 83
65087905:
SCOTSMAN ICE SRL



4122082 PULLEY
141 /
PULLEY 141
65087910:
SCOTSMAN ICE SRL



4114895 RV00B075-
CINGHIA DENTATA
196 XL 037 - ES /
RV00B075-TOOTHED
BELT 196 XL 037 - ES
RV00B075:
EURFRIGOR SRL
913003:
BRICE ITALIA SRL



4122265 CINGHIA
P3545 /
BELT P3545
624: I.T.V. S.A.



4114395 CINGHIA
CD 182XL037 B141206 /
BELT CD 182XL037
B141206
1TR039: MIGEL S.R.L.



4114427 CINGHIA
A27 /
BELT A27
1TR036: MIGEL S.R.L.

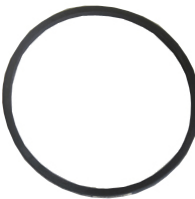

4122333 CINGHIA A
V TXPZ900 /
V BEL TXPZ900
65087801:
SCOTSMAN ICE SRL



4114308 GEAR
CASE KIT /
GEAR CASE KIT
CMCF00101501:
CASTEL MAC SPA
00101501:
SCOTSMAN ICE SRL



4114213 GEAR
CASE / GEAR CASE
0A03123001:
SCOTSMAN ICE SRL
CMCFA3123001:
CASTEL MAC SPA



4114930 ROTOR
ASSY /
ROTOR ASSY
79421600R:
SCOTSMAN ICE SRL



4114779 PIGNONE
CON ALBERO PER
MOTORIDUTTORE /
PIN FOR
MOTOREDUCER
NC20344: N.T.F. SRL
C20344:
BREMA ICE MAKERS
SPA



4114490 ROTOR
ASSY /
ROTOR ASSY
79412303R:
SCOTSMAN ICE SRL



4114488 STATORE /
STATOR
62039400:
SCOTSMAN ICE SRL
62052100:
SCOTSMAN ICE SRL



4122163 "MASCHER
INA; WITH BUTTON" /
"MASK, WITH
BUTTON"
092398:
ELECTROLUX
PROFESSIONAL
S.P.A.



4114806 MONITORI
NG PANEL /
MONITORING PANEL
19262733/0:
ICEMATIC
CM19262733/0:
CASTEL MAC SPA
CM19262733:
SCOTSMAN ICE SRL



4114361 MASCHERI
NA TASTIERA NEW S.
MISTA H. /
BOARD PANEL NEW
S. MISTA H.
RA130109:
MARENO
INDUSTRIE ALI SPA

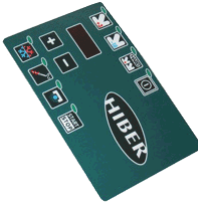

4122350 MASCHER
A CRUSCOTTO /
BOARD PLATE
MA4604412:
MARENO
INDUSTRIE ALI SPA



4122064 PANNELLO
COMANDI /
MEMBRANESWITCHK
IT
06061300:
SCOTSMAN ICE SRL



4122229 LABEL /
LABEL
1700283001:
SCOTSMAN ICE SRL



4122230 LABEL /
LABEL
1700283002:
SCOTSMAN ICE SRL



4122095 SCOTSMAN
EMBLEM /
SCOTSMAN EMBLEM
65085000:
SCOTSMAN ICE SRL



4114738 MONITORI
NG LED ASSY /
MONITORING LED
ASSY
65062410:
SCOTSMAN ICE SRL

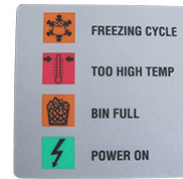

4114708 VALVOLA
COMPLETA 1/4"SAE A
SALDARE 50mm /
COMPLETE VALVE
1/4" SAE 50mm



4114709 VALVOLA
COMPLETA 1/4"SAE A
SALDARE 100mm /
COMPLETE VALVE 1/4"
SAE 100mm



4114386 CORPO
VALVOLA VUOTO-
CARICA /
VALVE BODY FOR
SCHRADER VALVE
14007:
BREMA ICE MAKERS
SPA



4114384 MECCANIS
MO VALVOLA
VUOTO-CARICA /
GEAR FOR
SCHRADER VALVE
14005:
BREMA ICE MAKERS
SPA



4114385 TAPPO
VALVOLA VUOTO-
CARICA /
NUT FOR SCHRADER
VALVE
14006:
BREMA ICE MAKERS
SPA



4114632 SPINOTTO
BIELLA N OTTONE /
BRASS PIN FOR ROD
RQ003626:
EURFRIGOR SRL
920020:
BRICE ITALIA SRL



4114477 EVAP.
PRESSURE REG.
VALVE /
EVAP. PRESSURE
REG. VALVE
62045402:
SCOTSMAN ICE SRL



4114478 LINEA
ASPIRAZIONE GAS
CALDO /
WARM GAS SUCTION
PIPE

14597:

BREMA ICE MAKERS
SPA



4114829 VARIO
GRANITORE /
PARTS FOR SLUSH
MACHINE

SL300000899:

GBG ALI SPA



4114365 RACCORD
O INGRESSO ACQUA
A 1 VIA /
CONNECTION WATER
1 WAY

10368:

BREMA ICE MAKERS



4114729 RACCORD
O INGRESSO ACQUA
A 1 VIA /
SOLENOID VALVE 1
WAY

10239:

BREMA ICE MAKERS



4122300 ANELLO
INGRESSO ACQUA /
RING WATER INLET

20851:

BREMA ICE MAKERS
SPA



4122177 RACCORD
O CENTRALE AD
INCASTRO /
SPRAY PLATEN SEAT

66077700:

SCOTSMAN ICE SRL



4114218 CHIAVETT
A 18,3x7,5x6,3 mm /
TANG 18,3x7,5x6,3 mm

0300136400:

SCOTSMAN ICE SRL

CMCF03136400:

CASTEL MAC SPA



4114542 SPECIAL
KEY /
SPECIAL KEY

74109204:

SCOTSMAN ICE SRL



4114067 PERNO
SPORTELLO
FABBRICATORE
GHIACCIO BREMA /
PIN FOR DOOR
BREMA

10269:

BREMA ICE MAKERS



4122041 Tirante M10
per fermo coltello /
Rod M10 for standstill
knife

20369:

BREMA ICE MAKERS



4122151 RQ003619-
ALBERO FRIZIONE
CAMME NEW /
RQ003619-CAM SHAFT
CLUTCH NEW

923002:

BRICE ITALIA SRL



4122029 RQ00C415-
ALBERO FRIZIONE
CAMME EC 130 /
RQ00C415-SHAFT
CLUTCH CAM EC 130

923001:

BRICE ITALIA SRL



4122067 RQ00A065-
ALBERO X
BACINELLA N EC
60/80/130 /
RQ00A065-TREE FOR
DRAIN N EC 60/80/130

923009: BRICE

RQ00A065:

EURFRIGOR



4114777 ALBERO
BACINELLA N25 /
PIN FOR N25 BASIN

825030021:

GRUPPO CIMBALI

SPA

25030021/0:

ICEMATIC

CM25030021/0:

CASTEL MAC SPA



L= 210 mm

4122002 BARRA DI
TORSIONE CPL -> /
TORSIONAL ROD
9097812:
MONDIAL GROUP
S.R.L.



4114217 SHAFT /
SHAFT
65115900:
SCOTSMAN ICE SRL
CMCF65115900:
CASTEL MAC SPA



4122172 METAL PIN
/
METAL PIN
72421507EX:
SCOTSMAN ICE SRL



4122187 METAL PIN
/
METAL PIN
72421510:
SCOTSMAN ICE SRL



4122158 TIE ROAD /
TIE ROAD
72418002:
SCOTSMAN ICE SRL



4122034 DISTRIBUT
ORASSY /
DISTRIBUTORASSY
1600084302:
SCOTSMAN ICE SRL



4114924 LINK ASSY
/
LINK ASSY
T01244:
SCOTSMAN ICE SRL



4122211 PENNINO
PER REGISTRATORE
RTAI /
STYLUS PEN FOR
RECORDER RTAI



4122212 PENNINO
PER JULES RICHARD /
STYLUS PEN FOR
JULES RICHARD



4122213 PENNINO
PER REGISTRATORE
GRAFICO RTD/Q /
STYLUS PEN
RECORDER FOR
GRAPHIC RTD / Q



4122042 Giunto /
COUPLING
20367:
BREMA ICE MAKERS
SPA



4114828 ALBERINO
ESAGONALE /
HEXAGONAL ARM
SL300000980:
GBG ALI SPA



4114937 WATER
INLET FITTING /
WATER INLET
FITTING
73320400:
SCOTSMAN ICE SRL



4114858 FITTING /
FITTING
73317400:
SCOTSMAN ICE SRL



4114941 WATER
FITTING /
WATER FITTING
73317301:
SCOTSMAN ICE SRL



4122309 WATER
FITTING /
WATER FITTING
CM25600225:
SCOTSMAN ICE SRL
CM256002250:
CASTEL MAC SPA



4122357 PERNO PER
COCLEA /
AUGER STUD
0800066001:
SCOTSMAN ICE SRL



4122411 CHIUSURA
M5 2930.MF94 /
closing
1CC054: MIGEL S.R.L.



4114691 STRIKE /
STRIKE
1500041100:
SCOTSMAN ICE SRL



4114594 TUBO
RISLAN 4/6 /
PIPE RISLAN 4/6
1DR036: MIGEL S.R.L.



4114169 GHIERA
BLOCCAGGIO
RACCORDI /
JOINT STOP RING
10405:
BREMA ICE MAKERS
SPA



4114170 DADO PER
SCARICO
CONTENTORE /
NUT FOR DRAIN
VALVE
10096:
BREMA ICE MAKERS
SPA



4122039 Ghiera per
anello rotante /
Nut for rotating ring
10194:
BREMA ICE MAKERS
SPA



4114180 DADO
PLASTICA
SCOTSMAN /
PLASTIC NUT
SCOTSMAN
889125098:
GRUPPO CIMBALI
66053500:



SIMAG SPA
66053500:
SCOTSMAN ICE SRL

4114577 NUT
ADJUSTING /
NUT ADJUSTING
0200361001:
SCOTSMAN ICE SRL



4114578 NUT,SUMP
DRAIN /
NUT,SUMP DRAIN
0200336001:
SCOTSMAN ICE SRL



4122457 4502
COUPLING NUT 90
ECO /
4502 COUPLING NUT
90 ECO
4502: I.T.V. S.A.



4114940 NUT / NUT
40007600:
SCOTSMAN ICE SRL



4114580 STAND
PIPE SUMP /
STAND PIPE SUMP
0200333901:
SCOTSMAN ICE SRL



4122189 GEAR
ROTOR BRACKET /
ROTOR GEAR
BRACKET
0200197100:
SCOTSMAN ICE SRL



4122222 ICE SWEEP
/ ICE SWEEP
0200300101:
SCOTSMAN ICE SRL

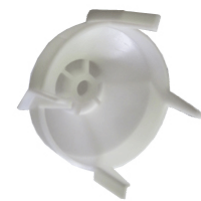

4122419 ICE SWEEP
/
ICE SWEEP
65072500:
SCOTSMAN ICE SRL



4122281 WATER
SHED /
WATER SHED
0200466301:
SCOTSMAN ICE SRL



4122232 DRIP PAN /
DRIP PAN
0200383701:
SCOTSMAN ICE SRL



4122120 COLTELLO
SB90 SB130 SB180 +
OR /
KNIFE SB90 SB130
SB180 + OR
9050370000:
STAFF ICE SYSTEM



4114072 SCARICO
MACCHINA MV18-25 /
DRAIN JUNCTION
MV18-25
CM25690806/0:
CASTEL MAC SPA
25690803/0:
ICEMATIC
CM25690806:
SIMAG SPA
25690806/0:
ICEMATIC
CM25690803/OEX:
CASTEL MAC SPA
CM25690806:
SCOTSMAN ICE SRL
825690806:
GRUPPO CIMBALI



4122239 TAPPO
RAMPA /
CAP RAMP
K00527:
ARISTARCO SPA



4114092 TAPPO
RAMPA
SPRUZZATORI /
SPRAY RAMP CAP
910093:
BRICE ITALIA SRL
10012:
BREMA ICE MAKERS
SPA



4114712 DRAIN
PLUG. /
DRAIN PLUG
25730503/0:
ICEMATIC
CM25730503:
SCOTSMAN ICE SRL
CM42062035:
SCOTSMAN ICE SRL



4122324 1 71 5
SLIDING DOOR
STOPPER /
1 71 5 SLIDING DOOR
STOPPER
101715: I.T.V. S.A.



4122326 STAFFA
INFERIORE
COMPLETA /
LOWER BRACKET
COMPLETE
30T2680:
ANGELO PO GRANDI
CUCINE SPA



4122328 STAFFA
SUPERIORE AMILB /
HINGE UPPER
36C5000:
ANGELO PO GRANDI
CUCINE SPA



4122009 Struttura
pompa /
structure pump
N10065: N.T.F. SRL
EU10065:
BRICE ITALIA SRL
10065:
BREMA ICE MAKERS
SPA



4114099 ALBERINO
SCOTSMAN /
BEARING SCOTSMAN
66047500:
SCOTSMAN ICE SRL



4122338 COPPIA
GUIDE TIPO C 605MM
/
COUPLE GUIDE TYPE
C 605 MM
0121160520:
COLD LINE S.R.L.



4122377 "GUIDA DI
SCORRIMENTO; SET
2PCS; 621X20MM" /
LEFT-RIGHT GRILL
SLIDE 620x20 mm - 2
PCS
093851:
**ELECTROLUX
PROFESSIONAL
S.P.A.**



4114813 GUIDA
RIPIANO; 580X20 MM /
SHELF SLIDEWAYS
580x20 mm
082263ex:
**ELECTROLUX
PROFESSIONAL
S.P.A.**
093850:
**ELECTROLUX
PROFESSIONAL
S.P.A.**



4114641 COPPIA
GUIDA INOX 650X22 /
STAIN LESS STEEL
GUIDEWAY



4122283 RUOTA
PIROETTANTE /
REVOLVING WHEEL
CM19651011/0:
CASTEL MAC SPA
CM19651011:
SCOTSMAN ICE SRL



DIAMETER= 125 mm

4122284 RUOTA /
WHEEL
*:
CASTEL MAC SPA
CM19651010:
SCOTSMAN ICE SRL



DIAMETER= 125 mm

4114526 TUBO
KRISTALLO 24/30 /
CRYSTAL PIPE 24/30
IDR009: MIGEL S.R.L.



4122485 WATER
DISTRIBUTOR COVER
/
WATER DISTRIBUTOR
COVER
0200406501:
SCOTSMAN ICE SRL



4122061 TUBO
DISTRIBUZIONE
ACQUA /
WATER
DISTRIBUTION TUBE
IOM204133801:
SCOTSMAN ICE SRL



4114576 DRAIN
TUBE /
DRAIN TUBE
0200333801:
SCOTSMAN ICE SRL



4114693 TUBE /
TUBE
61016700:
SCOTSMAN ICE SRL



4122303 TUBE /
TUBE
61016906:
SCOTSMAN ICE SRL



4122225 ANTIVIBR
ANTE MASCHIO-
FEMMINA 3/4G DN20 /
PIPE ANTIVIBRATION
MALE-FEMALE 3 / 4G
DN20
CM25000106/0:
CASTEL MAC SPA



4114684 GOOSNECK
GLASS FILLER /
GOOSNECK GLASS
FILLER
CS0002521705:
SCOTSMAN ICE SRL



4122267 EROGATOR
E ACQUA /
WATER TAP
CS0002521706:
SCOTSMAN ICE SRL



4114313 ASSIEME
PUSH EROGATORE /
DISTRIBUTOR PUSH
SET

C26544:

BREMA ICE MAKERS
SPA



4122076 CLIP
PLASTICA 1/4" /
CLIP PLASTIC 1/4 "

503533: I.T.V. S.A.



4122085 RACCORD

O "Y" ART.468 /
FITTING "Y" ART.468

1DR030: MIGEL S.R.L.



4114885 T FITTING /
T FITTING

CS0002521364:

SCOTSMAN ICE SRL



4122059 ELBOW /
ELBOW

1600067101:

SCOTSMAN ICE SRL



4122458 4594
COUPLING 90 ECO 1
30 /

4594 COUPLING 90
ECO 1 30

404594:

I.T.V. S.A.



4114107 ELASTOME
RO ANTIVIBRAZIONI /
ELASTIC JOINT

20494:

BREMA ICE MAKERS
SPA



4122011 RH000666-
FLANGIA DI
FISSAGGIO SCARICO
ACQUA /
RH000666 WATER
DRAIN FIXING
FLANGE

910055:

BRICE ITALIA SRL



4122210 CILINDRI
PER P03-P06 /
CYLINDER FOR P03-
P06

CM400UMCL01:

CASTEL MAC SPA



4122209 KIT SIFONE

P03-P06 /

KIT SIPHON P03-P06

CM400UMSIF01:

CASTEL MAC SPA



4114262 CLIPS

INOX 22X43 PER
GRIGLIE /
STAINLESS STEEL
CLIPS 22X43



4122066 SUPPORTO

/
SUPPORT

MA4624800:

MARENO

INDUSTRIE ALI SPA



4114855 BRACKET /
BRACKET

65034100:

SCOTSMAN ICE SRL

CMCF65034100:

CASTEL MAC SPA

CF65034100:

ICEMATIC



4122489 CLAMP /
CLAMP

CMCF65049900:

CASTEL MAC SPA

65049900:

SCOTSMAN ICE SRL



4114406 DISSIPATO
RE DI CALORE /
HEAT SINK

22430:

BREMA ICE MAKERS
SPA



4122014 Piastrina
premicro /
Micro plate press
22359:
**BREMA ICE MAKERS
SPA**



4122055 SUPPORTO
RIBALTATORE KP
50:120 /
HARVEST MOTOR
SUPPORT KP 50:120
1CR018: **MIGEL S.R.L.**



4122409 SUPPORTO
RIBALTATORE
KP20/30/40 / SUPPORT
FOR TILTER KP
20/30/40
1CR031: **MIGEL S.R.L.**

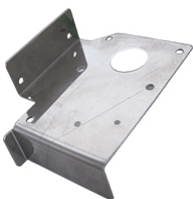

4114531 FAN
MOTOR BRACKET /
FAN MOTOR
BRACKET
62041965:
SCOTSMAN ICE SRL



4114666 SUPP.SENS
ORE PIASTRA M180 /
BRACKET
25725450/0:
ICEMATIC
CM25725450/0:
CASTEL MAC SPA
CM25725450:
SCOTSMAN ICE SRL



4114946 PUMP
BRACKET /
PUMP BRACKET
72189300:
SCOTSMAN ICE SRL

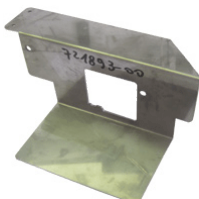

4114674 BLADE /
BLADE
76400101:
SCOTSMAN ICE SRL



4122018 CUTTINGD
RUM /
CUTTINGDRUM
T01602:
SCOTSMAN ICE SRL



4122336 AIR FILTER
SEAT /
AIR FILTER SEAT
66080402:
SIMAG SPA
AC126-176-206-226
7 EC126-176-206-226
MC16-8:
SCOTSMAN ICE SRL



4114919 AIR FILTER
SEAT /
AIR FILTER SEAT
66080401:
SCOTSMAN ICE SRL



4114977 ELECT.CO
NNECTION COVER /
ELECT.CONNECTION
COVER
63010500:
SCOTSMAN ICE SRL



4114978 ANELLO
ELASTICO /
CLIP
0300153909:
SCOTSMAN ICE SRL



4114717 DISCHETT
O DI CHIUSURA ø 70
mm /
CLOSING DISK ø 70
mm
22825:
**BREMA ICE MAKERS
SPA**



ø 70 mm

4114272 DISCHETT
O DI CHIUSURA /
CLOSING DISK
22649: **N.T.F. SRL**
22649:
**BREMA ICE MAKERS
SPA**

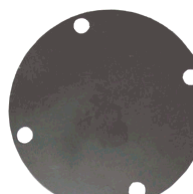

4114312 GUARNIZI
ONE /
GASKET
CF64006000:
ICEMATIC
I64006000:
GIGA GRANDI
CUCINE SRL
CMCF64006000:
CASTEL MAC SPA
64006000:
SCOTSMAN ICE SRL



4122237 SIGHT
GLASS /
SIGHT GLASS
66033700:
SCOTSMAN ICE SRL



4122278 ALLOGGIA
MENTO
INTERRUTTORE
SICUREZZA /
HOUSING SAFETY
SWITCH
70523400:
SCOTSMAN ICE SRL



P= 27 mm, H= 39 mm,
L=190 mm

4114418 FLOAT
BAR /
FLOAT BAR
0200338303:
SIMAG SPA
0200338303:
SCOTSMAN ICE SRL



4114481 GRID /
GRID
62033800:
SCOTSMAN ICE SRL
CF62033800:
ICEMATIC
CMCF62033800:
CASTEL MAC SPA



4114506 DRIPS
SHIELD /
DRIPS SHIELD
66053800:
SCOTSMAN ICE SRL



4114588 BANDIERI
NA SENSORE KV /
FLAG SENSOR KV
1DR066: MIGEL S.R.L.



4122426 FRONT+TO
P PANEL KIT /
FRONT+TOP PANEL
KIT
66067304:
SCOTSMAN ICE SRL
06060003:
SCOTSMAN ICE SRL



DIMENSIONS
FRONT=805X390mm,
TOP=555X385mm,

4122454 KIT
TRASFORMAZIONE
CD40 (KIT
PORTABICC /
KIT
TRANSFORMATION
CD40
CM814091760:
CASTEL MAC SPA
CM81409176:
SCOTSMAN ICE SRL



4114672 HARVEST
ASSIST SOLENOID /
HARVEST ASSIST
SOLENOID
CM19270501:
SCOTSMAN ICE SRL



4119037 RASCHIAT
ORE ESTERNO PER
SISTEMA
MAGNETICO BIANCO
/
SCAPER
2280016102:
UGOLINI SPA



4119104 MESCOLA
TORE INTERNO
BIANCO /
INTERNAL MIXER
WHITE
3380008001:
UGOLINI SPA



4119123 MESCOLA
TORE INTERNO
GRIGIO PER MT IN
ALTERNATIVA
4119104 /
INTERNAL MIXER
3380008002:
UGOLINI SPA



4119092 CONTENIT
ORE 12 L /
CONTAINER 12 L
2280025201:
UGOLINI SPA



4119046 CONTENIT
ORE COMPLETO DI
FONDO /
CONTANEIR
3380009901:
UGOLINI SPA



4119132 CONTENIT
ORE GRANITORE 6 LT
/
CONTAINER SLUSH 6
LT
2270000200:
UGOLINI SPA



4119084 CONTENIT
ORE 8 LT ARCTIC /
CONTAINER 8LT "
ARCTIC"
2290002000:
UGOLINI SPA



4119110 CONTENIT
ORE DISTRIBUTORE
GRANITA 10 L /
SLUSH DISPENSER
BOX 10 L
2280017400:
UGOLINI SPA



4119107 CONTENIT
ORE DISTRIBUTORE
GRANITA 10 L /
SLUSH DISPENSER
BOX 10 L
2280017404:
UGOLINI SPA



4119125 CONTENIT
ORE POLVERE
DESTRO CON
COPERCHIO /
CONTAINER DUST
RIGHT - WITH COVER
2260001110:
UGOLINI SPA



4119126 CONTENIT
ORE POLVERE
SINISTRO CON
COPERCHIO /
CONTAINER DUST
LEFT - WITH COVER
2260001100:
UGOLINI SPA



4119127 CONTENIT
ORE POLVERE
SIMMETRICO CON
COPERCHIO /
CONTAINER FOR
DUST - SYMMETRIC
WITH COVER
2260001130:
UGOLINI SPA



4119128 CONTENIT
ORE POLVERE
STRETTO CON
COPERCHIO /
TIGHT CONTAINER
FOR DUST - WITH
COVER
2260001121:
UGOLINI SPA

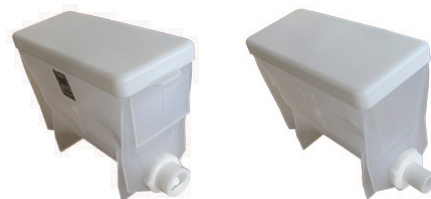

4119096
COPERCHIO
TRASPARENTE /
TRANSPARENT
COVER
2280023400:
UGOLINI SPA



4119136 CAPPELLO
PER MT 6 COOL
GRAY /
COVER MT8 GRAY
2270001400:
UGOLINI SPA



4119100 COPERCHI
O COMPLETO NERO
CON LUCE MT GL/UL
/
COVER COMPLETE
WITH BLACK LIGHT
MT GL / UL
3380004806:
UGOLINI SPA



4119088
COPERCHIO
CONTENITORE 58 LT
POLIC COMPACT
JOLLY /
LID FOR 58 LT POLIC
COMPACT JOLLY
2290001300:
UGOLINI SPA



4119089 COPERCHI
O CONTENITORE 12 L
/
COVER BOX 12 L
2280025101:
UGOLINI SPA



4119137 COPERCHI
O SPALLA
PORTAFOTO MT /
COVER MT
2280017540:
UGOLINI SPA



4119105 COPERTUR
A TRASPARENTE
FOTO SPALLA /
TRANSPARENT
COVER PHOTOS
SHOULDER
1002803703:
UGOLINI SPA

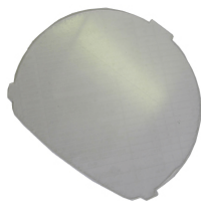

4119135 CASSETTO
RACCOGLIGOCCE MT
BLK /
DRIP TRAY MT BLK
2290003801:
UGOLINI SPA



4119146 CASSETTO
BIANCO /
DRIP TRAY WHITE
2280026464:
UGOLINI SPA



4119102
CASSETTO
RACCOGLIGOCCE MT
COOL GRAY /
DRIP TRAY MT COOL
GRAY
2290003800:
UGOLINI SPA



4119119 CASSETTO
RACCOGLIGOCCE
GRIGIO /
DRIP TRAY GREY
2280000600:
UGOLINI SPA



4119103 GRIGLIA
CASSETTO
RACCOGLIGOCCE MT
NEW HT ABS /
GRILL DRIP TRAY
NEW MT HT ABS
2290003700:
UGOLINI SPA

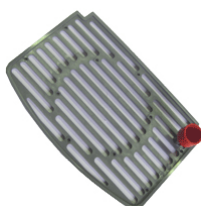

4119116 GRIGLIA
CASSETTO
RACCOGLIGOCCE
BLU /
GRID DRIP TRAY
BLUE
2280000560069:
UGOLINI SPA

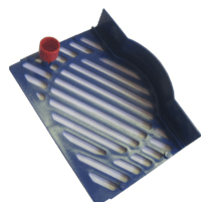

4119083 GOMMA
RUBINETTO /
TAP RUBBER



4119063 PERNO
ROSSO PER LEVA
RUBINETTO /
TAP PIN
2280022100:
UGOLINI SPA



4119039 PERNO
NERO PER LEVA
RUBINETTO /
TAP PIN
2280022160:
UGOLINI SPA



4119040 PISTONE
RUBINETTO
MACCHINA
BEVANDE CALDE /
TAP PISTON
2280014801:
UGOLINI SPA



4119055 PISTONE
PER RUBINETTO /
TAP PISTON
2280014800:
UGOLINI SPA



4119114 TUBO
CENTRALE PER
CIOCCOLAT. 3 LT /
CENTRAL TUBE FOR
CHOCOLATE. 3 LT
2250000400:
UGOLINI SPA



4119082 LEVA
RUBINETTO /
LEVER COCK



4119093 COPERCHI
O GRANITORE SPM /
GRAINER COVER
(SPM)



4119041 LEVA
COMANDO
RUBINETTO ROSSA
TAP LEVER
2270001800:
UGOLINI SPA



4119056 LEVA
RUBINETTO ROSSA
PER MT /
TAP LEVER MT
2280014900ex:
UGOLINI SPA



4119101 LEVA
RUBINETTO NERA
PER MT /
LEVER BLACK COCK
FOR MT
2280027401:
UGOLINI SPA



4119074 LEVA
COMANDO
RUBINETTO /
TAP LEVER
2290000561:
UGOLINI SPA



4119076 LEVA
EROGAZIONE VERDE
/
TAP LEVER
2270001860:
UGOLINI SPA



4119073 COPRIRUB
INETTO /
TAP COVER
2290000860:
UGOLINI SPA



4119057 CALOTTA
IN GOMMA /
RUBBER COVER
2280023502:
UGOLINI SPA



4119058 BOCCOLA
DI RASAMENTO /
BUSH
2280023501:
UGOLINI SPA



4119059 BOCCOLA
FRONTALE/
BUSH
1002802803:
UGOLINI SPA



4119060 BOCCOLA
POSTERIORE SPALLA
GRANITORE /
BUSH
1002802802:
UGOLINI SPA



4119061 RASAMEN
TO PER ROTORE
INTERNO / WASHER
1002802805:
UGOLINI SPA



4119064 GOMMINO
BIANCO RUBINETTO
CONTENITORE 12/19L
/
CONTAINER TAP
RUBBER
1002801900:
UGOLINI SPA



4119133 TRASFOR
MATORE TL60C
220V/50-60Hz /
TRANSFORMER
TL60C 220V/50-60Hz
2280018202EX:
UGOLINI SPA
2280018230:
UGOLINI SPA

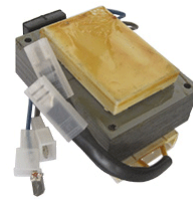

4119120 GRUPPO
RUOTA CON
CUSCINETTO
6/3392045 /
WHEEL GROUP
BEARING 6/3392045
ZZZZ0001002:
SPM DRINK
SYSTEMS SPA



4119122 GRUPPO
RUOTA CON
CUSCINETTO6/339204
6 /
WHEEL GROUP
BEARING 6/3392045
ZZZZ0001001:
SPM DRINK
SYSTEMS SPA



4119087 PRIMA
RUOTA DENTATA
SERIE 2 /
FIRST GEAR SERIES 2
2280022639:
UGOLINI SPA



4119075 SECONDA
RUOTA DENTATA
SERIE 2 /
SECOND GEAR 2
2280022640:
UGOLINI SPA



4119118 SEDE PER
ROTORE
EVAPORATORE /
SEAT FOR ROTOR
EVAPORATOR
2270000500:
UGOLINI SPA



4119129 PULEGGIA
MAGNETE
COMPLETA H. 19,5
COMPACT JOLLY 5-
8LT /
PULLEY COMPLETE
MAGNET H. 19.5
COMPACT JOLLY 5- 8
LT
3390001052:
UGOLINI SPA



4119090
AGGANCI
CONTENITORE /
HOOKING
CONTAINER
2210200000:
UGOLINI SPA



4119097 GOMMINO
CON CONTATTO /
CONTACT WITH
RUBBER
2280022861:
UGOLINI SPA



4119134 BLOCCHET
TO GUIDAMOLLA
GRIGIO /
GREY SPRING GUIDE
2280016900ex:
UGOLINI SPA
2280016960:
UGOLINI SPA



4119098 ANELLO
DI ANCORAGGIO
CONTENITORE 10 L /
ANCHORAGE RING
BOX 10 L
2280023000:
UGOLINI SPA



4119106 ANELLO
DI GOMMA /
RUBBER RING
0380008600EX:
UGOLINI SPA



4119113 BOCCOLA
IN RULON /
BUSH IN RULON



4114176 SCIVOLO
CUB. TRATTATO VM-
VB /
SLIDES CUBE
D12057:
BREMA ICE MAKERS
SPA



DIMENSIONS
150x454mm

4122051 Scivolo
cubetti /
slide cubes
D12031:
BREMA ICE MAKERS
SPA



DIMENSIONS
185x665 mm

4114330 SCIVOLO
CUBETTI /
GRID
D12017:
BREMA ICE MAKERS
SPA



DIMENSIONS
203X670mm

4114194 SCIVOLO
CUBETTI /
CHUTE CUBES
D12001:
BREMA ICE MAKERS
SPA



DIMENSIONS
205x325mm

4122359 SCIVOLO
CUBETTI TRATTATO
CUB. 'D' /
CHUTE CUBE CUB. 'D'
D12046:
BREMA ICE MAKERS
SPA



DIMENSIONS
208x325mm

4122463 SCIVOLO
CUBETTI TRATTATO
CUB. 'C-E' /
CHUTE CUBES 'C-E'

D12030:

BREMA ICE MAKERS
SPA



DIMENSIONS
210X435mm

4122302 RN00A018-
CONTRO-BACINELLA
EC 40/50 NEW
233x162x62 mm /
RN00A018-CHUTE FOR
BASIN EC 40/50 NEW
233x162x62 mm

923018:

BRICE ITALIA SRL



DIMENSIONS
160x235 mm

4114143 SCIVOLO
CUB. TRATTATO CUB.
C /
GRILL FOR ICE
MAKERS C

D12033:

BREMA ICE MAKERS



4114794 CONTROBA
CINELLA EC 20/30
NEW /
SLIDE GRATE EC 20/30
NEW

RN00A017:

EURFRIGOR SRL

923014: BRICE

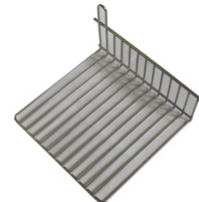

4137001 GRIGLIA
CUBETTI 30/40 KG. /
GRILL FOR ICE
MAKERS 30/40KG

D12008:

BREMA ICE MAKERS
SPA



DIMENSIONS 435x210
mm

4114893 RN000932-
SCIVOLO CUBETTI EC
30/40 /
CHUTE EC30/40

912003:

BRICE ITALIA SRL

RN000932:

EURFRIGOR SRL



4137110 SCIVOLO
INTERNO BACINELLO
TRATTATO /
INTERNAL CHUTE
BASIN

D12043:

BREMA ICE MAKERS
SPA

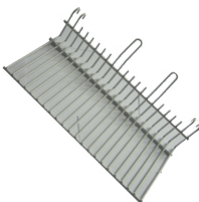

DIMENSIONS
282X135mm, H=70mm

4137077 GRIGLIA
CONVOGLIATRICE EC
20 340mm x150mm /
CHUTE FOR EC20

912001:

BRICE ITALIA SRL

RN000931:

EURFRIGOR SRL



DIMENSIONS
340mm x150mm

4137113 SCIVOLO
INTERNO
BACININELLA
TRATTATO /
INTERNAL CHUTE
BASIN

D12048:

BREMA ICE MAKERS
SPA



4122245 RN00A139-
SCIVOLO CUBETTI EC
130 N /
RN00A139-CHUTE
CUBES EC 130 N

EC130:

BRICE ITALIA SRL



L=860mm

4137084 SCIVOLO
CUBETTI /
CHUTE

D12078:

BREMA ICE MAKERS
SPA



DIMENSIONS
562X250mm

4137107 RN000928-
SCIVOLO CUBETTI EC-
60 /
RN000928-SLIDE
CUBES EC-60

912004:

BRICE ITALIA SRL



DIMENSIONS
425X182mm

4114760 CONTROBA
CINELLA N EC 20
COMP. /
CHUTE FOR BASIN N
EC20

RN00A016:

EURFRIGOR SRL

923019:

BRICE ITALIA SRL

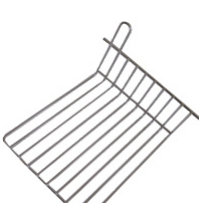

DIMENSIONS
127X160X60mm

4137127 RN000933-
SCIVOLO CUBETTI EC
80 /
CHUTE CUBES EC 80

912006:

BRICE ITALIA SRL



DIMENSIONS
540X170mm

4114808 GRIGLIA
POSTER.EC30/40/50S
ES50 ECP32/42 /
BACK GRID FOR
EC30/40/50S ES50
ECP32/42
RNO0B417:
EURFRIGOR SRL
912012:
BRICE ITALIA SRL



4137074 GRIGLIA
SCORRIMENTO
CUBETTI /
GRID SLIDE CUBES
CMNM65068800:
CASTEL MAC SPA
65068800:
SCOTSMAN ICE SRL



DIMENSIONS
285X220mm

4137029 ASSIEME
CONVOGLIATORE
CUBETTI N20 /
CUBES CONVEYER
SET N20
CM81403045:
CASTEL MAC SPA
CM81403045:
SCOTSMAN ICE SRL



DIMENSIONS
113X167mm, H=60mm

4137005 ASSIEME
CONV. CUBETTI N30 /
GRILL FOR ICE
MAKERS N30
CM81403025/0:
CASTEL MAC SPA
CM81403025:
SCOTSMAN ICE SRL



DIMENSIONS
148X170mm H=60mm

4114134 ASS.
CONVOGLIATORE
CUBETTI N5 /
GRILL FOR ICE
MAKERS N5
CM81413031/0:
CASTEL MAC SPA
CM81413031:
SCOTSMAN ICE SRL

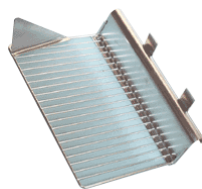

DIMENSIONS
167X255mm

4114090 ASS.
CONVOGLIATORE
CUBETTI N75 /
CUBES CONVEYER
SET N75
CM81423063/0:
CASTEL MAC SPA
CM81423063:
SCOTSMAN ICE SRL
CM81423063/0:
CASTEL MAC SPA



DIMENSIONS
167X436mm

4122013 CHUTE /
CHUTE
CMXG65068401:
CASTEL MAC SPA
65068401:
SCOTSMAN ICE SRL



DIMENSIONS
200X577mm

4137125 SCIVOLO
CUBETTI A GRIGLIA
250X170mm /
ICE CHUTE 250X170mm
CM19680501/0:
CASTEL MAC SPA



DIMENSIONS
250X170mm

4137119 SCIVOLO
CUBETTI KL41/51 /
CHUTE CUBES KL
41/51
1CD010: MIGEL S.R.L.



DIMENSIONS
393x220mm

4137108 SCIVOLO
CUBETTI KL18/21 /
SLIDE CUBES KL18 / 21
1CD008: MIGEL S.R.L.



DIMENSIONS
250X165mm

4122420 SCIVOLO
CUBETTI KL131:301 /
ICE CHUTE KL131:301
1CD012:
MIGEL S.R.L.



DIMENSIONS
890X234mm

4122382 SCIVOLA
CADUTA CUBETTI
290X200mm /
ICE DEFLECTOR
290X200mm
65085900:
SCOTSMAN ICE SRL



DIMENSIONS
200X290mm

4122416 GRIGLIA
CADUTA CUBETTI
578X232mm /
ICE CHUTE -
578X232mm
65069000:
SCOTSMAN ICE SRL



DIMENSIONS
578X232mm

4137024 GRIGLIA
SCORRIMENTO
CUBETTI 945X231mm /
GRID SLIDE CUBES
945X231mm
Z1AC005:
SCOTSMAN ICE SRL



DIMENSIONS
945X231mm

4122423 ICE CHUTE /
ICE CHUTE
65069002:
SCOTSMAN ICE SRL



DIMENSIONS
950X232mm

4122194 SCIVOLO
CUBETTI /
ICE CHUTE
65074101:
SCOTSMAN ICE SRL



4114376 GRIGLIA /
GRID
65122700:
SCOTSMAN ICE SRL
Z1AC004:
SCOTSMAN ICE SRL



4122141 ICE CHUTE /
ICE CHUTE
65069001:
SCOTSMAN ICE SRL



4137057 GRIGLIA
SCORRIMENTO
CUBETTI /
CHUTE
65070700:
SIMAG SPA
65070700:
SCOTSMAN ICE SRL
889125091:
GRUPPO CIMBALI



DIMENSIONS
305X167mm

4114179 GRIGLIA
CADUTA CUBETTI /
GRID
Z1AC050:
SIMAG SPA
65070500: SIMAG
889125090:
GRUPPO CIMBALI



4137060 GRIGLIA
PLASTIFICATA GRIGIO
SCURO 530X325MM
G1/1 /
PLASTIC GRILL
530X325MM

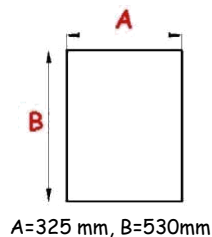
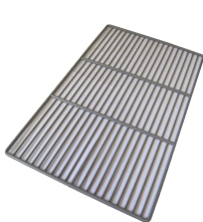

4137087 "GRIGLIA
FORNO; INOX;
530X325X12MM; 1PCS"
/
GRILL OVEN; STEEL;
530X325X12MM; 1PCS"
050868:
ELECTROLUX
PROFESSIONAL
S.P.A.

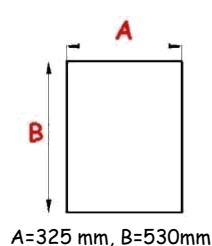
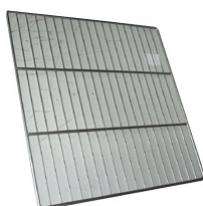

4137059 GRIGLIA
FORNO INOX 325X530
MM /
STAINLESS STEEL
GRILL FOR OVEN
325X530 MM
055428:
ELECTROLUX
PROFESSIONAL
S.P.A.

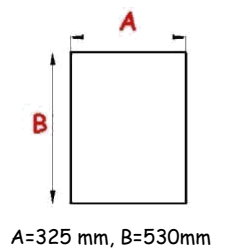

4137105 GRIGLIA
FRIGO 490X385
RILSAN /
GRILL REFRIGERATOR
490X385 Rilsan

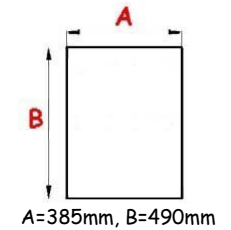

4137078 GRIGLIA
PLASTIFICATA
400X600 MM
POLIETILENE GRIGIO
SCURO RAL 7036 /
GRID PLASTIC 400x600
MM

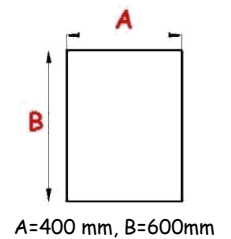

4137096 GRIGLIA
PLASTIFICATA
BIANCA X KIC P40
0621092 518X408 /
GRID PLASTIFIED
WHITE X KIC 0621092
P40 518X408

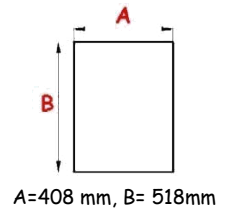

4137065 GRIGLIA
RILSAN 633X463MM /
RILSAN GRID
633X463MM

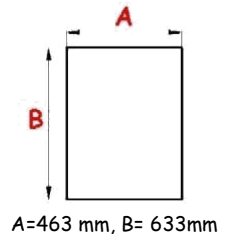

4137050 GRIGLIA
MACH /
GRILL MACH

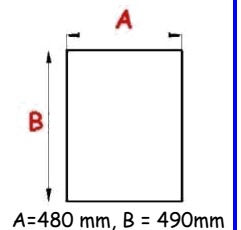
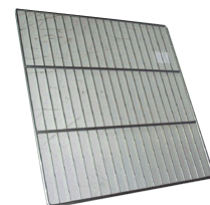

4137061 GRIGLIA
PLASTIFICATA
535X520MM /
PLASTIC GRILL
535X520MM

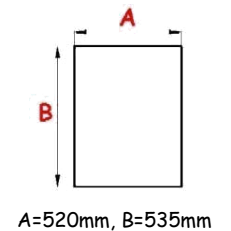
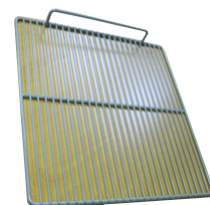

4137054 GRIGLIA
PLASTIFICATA ILSA
530X550MM CON
ALZATINA /
PLASTIC GRILL ILSA
530X550MM WITH
BACKSPLASH

36A5380:
ANGELO PO GRANDI
CUCINE SPA

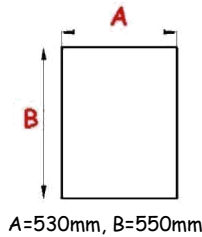
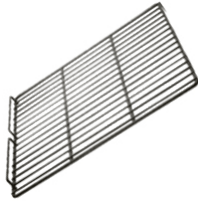

A=530mm, B=550mm

4137037 GRIGLIA
GN 2/1 530X650
PLASTIFICATA /
GRILL GN 2/1 530X650

AAG0000541:
MBM- EUROTEC SRL -
DIV. COOKING
SERVICE
02518600R:
MBM- EUROTEC SRL
- DIV. COOKING
SERVICE

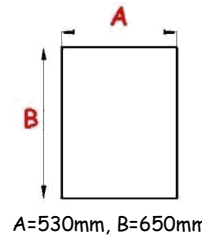
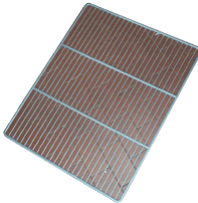

A=530mm, B=650mm

4137017 GRIGLIA
INOX 530X650mm
GN2/1 /
STAINLESS STEEL
GRID 530X650mm
GN2/1

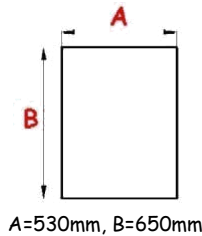
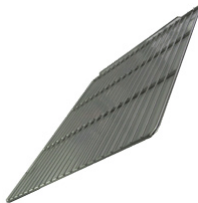

A=530mm, B=650mm

4137025 GRIGLIA
FRIGO PLASTIFICATA
GN 2/1 530X650 CON
ALZATINA /
FRIDGE PLASTIC
GRILL GN 2/1 53,5X65

BN1440065530 :
OLIS DIVISIONE DI
ALI GROUP SPA -
083635:
ELECTROLUX
PROFESSIONAL
S.P.A.
BN1440065530:
SILKO ALI SPA

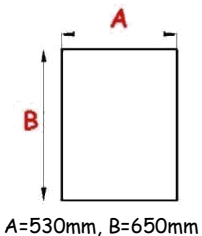

A=530mm, B=650mm

6101040 TESTATA
EVERPURE QL3B /
WATER-SOFTNER
HEAD EVERPURE
QL3B



H=63mm

6101074 CARTUCCIA
FILTRO AC BEV.23 /
CARTRIDGE AC
BEV.23

20302:
BREMA ICE MAKERS
SPA

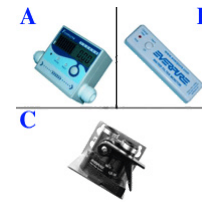

A= 6101051, B=6101052,

C=6101040, H=223mm,
Ø=78mm

6101042 CARTUCCIA
FILTRO MEDIA 4H
EVERPURE FOR
ICEMAKER /
4H CARTRIDGE M/L

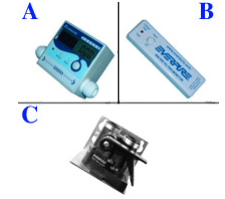

A= 6101051, B=6101052,
C= 6101040,
Capacity=11350 Lt,
H=337mm, Ø=78mm

6101043 CARTUCCIA
FILTRO GRANDE MH
EVERPURE FOR
ICEMAKER /
MH CARTRIDGE M/L
20301:
BREMA ICE MAKERS
SPA

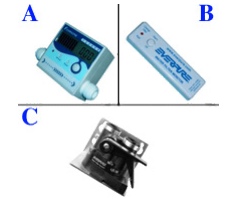

A= 6101051, B=6101052,
C= 6101040,
Capacity=34050 Lt,
H=490mm, Ø=78mm

6101044 CARTUCCIA
FILTRO I2000²
EVERPURE FOR
ICEMAKER /
INSURICE 2000
CARTRIDGE

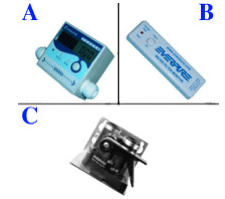

A= 6101051, B=6101052,
C= 6101040,
Capacity=34050 Lt,
H=490mm, Ø=78mm

6101096 CARTUCCIA
FILTRANTE I4000²
EVERPURE FOR
ICEMAKER (45000lt) /
INSURICE I4000²
CARTRIDGE FOR
ICEMAKER (45000lt)



A= 6101051, B=6101052,
C= 6101040,
Capacity=45425Lt,
H=603mm, Ø=88mm

6101095 KIT
TESTATA TWIN /
KIT TWIN HEAD



FILTER= 6101044

6101075 SISTEMA
INSURICE TWIN-2000² /
INSURICE SYSTEM
TWIN-2000²



68000 lt

6101070 CARTUCCIA
MC2 /
CARTRIDGE MC2

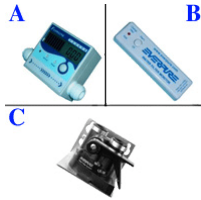

A= 6101051, B=6101052,
C= 6101040, 34000lt,
H=490mm, Ø=78mm

6101066 CARTUCCIA
FILTRO MEDIA 4C
BEVERAGE /
FILTER CARTRIDGE 4C
EVERPURE

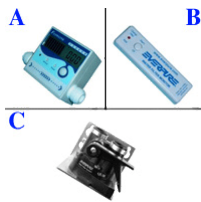

A= 6101051, B=6101052,
C= 6101040,
capacity= 11355lt,
H=337mm, Ø=78mm

6101097 CARTUCCIA
PER SCALEKLEEN
SANITIZING /
CARTRIDGE FOR
SANITIZING
SCALEKLEEN



TESTATA=6101040,
CONFEZIONE
1KG=1143059

6101051 WATER
METER /
WATER METER



6101059 CONTALITR
I AQUAMETER
WATER+MORE /
WATER METER
WATER+MORE



6101052 FILTER
MONITOR /
FILTER MONITOR



6101073 CONTALITR
I ACQUA FREDDA
SECCO 3/4" /
COLD WATER METER
3/4"

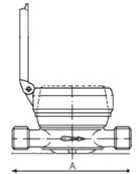

A=130mm

6101076 ADDOLCITO
RE A SACCHETTO IN
SCATOLA /
WARTERSOFTNERBAG
IN A BOX



1101833 RESISTENZ
A PER VENTILATORI
TANGENZIALI 8L180
2000W-230V /
RESISTANCE TO FANS
TANGENZIALI 8L180
2x100W)



FAN=1103857,
FAN=1103856,
FAN=1103858

1101527 RESISTENZ
A PTC 230W /
HEATING ELEMENT
PTC 230W
3263310:
ANGELO PO GRANDI
CUCINE SPA



1101811 RESISTENZ
A 230V 150W A
CARTUCCIA /
HEATING ELEMENT
230V 150W CARTRIDGE
3370:
ARISTARCO KASTEL
SPA



A= 16 mm, L= 990 mm

1101340 RESISTENZ
A CARTUCCIA 230V
80W /
CARTRIDGE HEATING
ELEMENT 230V 80W
HOT DOG - TP: CB
SRL



1101123 RESISTENZ
A FRIGORIFERO 083814
L=4000MM D12
X120MM 95W /
REFRIGERATOR
HEATING ELEMENT
083814

083814:
ELECTROLUX
PROFESSIONAL
S.P.A.

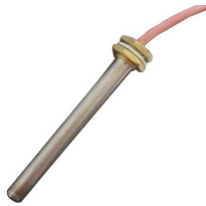

L=120mm, Ø=12mm

1101126 RESISTENZ
A AUTOREGOLAZIONE
+PTC MARENO /
AUTOREGULATION
HEATING
ELEMENT+PTC
MARENO

MA4646700:
MARENO INDUSTRIE
ALI SPA
4646700:
SILKO ALI SPA



L=230mm

1101443 RESISTENZ
A GRUPPO MASTER
14W /
HEATING ELEMENT
GR. MASTER 14W
14100035:
NUOVA SIMONELLI
SPA



1101675 RESISTENZ
A CARTUCCIA W 500
V.230 Lc=250 /
HEATING ELEMENT
500W V230 L=250



1101625 RESISTENZ
A CARTUCCIA W 800
V.230 LC=250 PER
NUVOLA /
CARTRIDGE HEATING
ELEMENT 800W 230V
LC=250



A= 12 mm, L= 90 mm

1101154 RESISTENZ
A DI SCARICO L. 2000
230V /
DRAIN HEATING
ELEMENT L. 2000 230V



1101864 RESISTENZ
A 500W 230/1/50 /
HEATING ELEMENT
500W 230/1/50
CM33575125/0:
CASTEL MAC SPA



P=135mm, H=125mm,
Ø=21mm, L=240mm

1101886 RESISTENZ
A 135W 230V
EVAP.COND. FV TRAD.

/
CONDENSE
EVAPORATION
HEATING ELEMENT
135W 230V

01943002R: MBM
01943003R: MBM

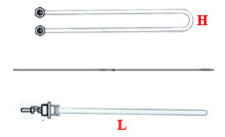

P=102mm, L=475mm

1101347 RESISTENZ
A FREEZERS /
REFRIGERATOR
HEATING ELEMENT

082731:
ELECTROLUX
PROFESSIONAL
S.P.A.



1101365 RESISTENZ
A SBRINAMENTO MBM
D140B2 /
DEFROSTING HEATING
ELEMENT MBM
D140B2

RIC0002969:
MBM- EUROTEC SRL -
DIV. COOKING
SERVICE
01152601:
MBM- EUROTEC SRL -
DIV. COOKING
SERVICE

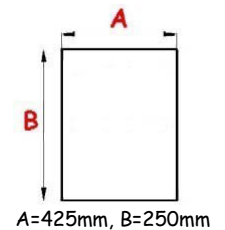

A=425mm, B=250mm

1101483 RESISTENZ
A FRIGO 400W 220V /
HEATING ELEMENT
FOR REFRIGERATOR
400W 220V

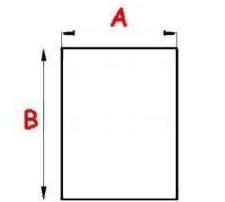

1101799 RESISTENZ
A MOD. CA 3000 220V
60W L 3000 MM /
HEATING ELEMENT
MOD. AC 220V 60W
3000 L 3000 MM



L=3000mm

1101755 RESISTENZ
A MOD. CA 5000 220V
100W L 5000 MM /
HEATING ELEMENT
MOD. AC 220V 100W
5000 L 5000 MM



1101561 RESISTENZ
A ANTICONDENSA
SILICONE 6000MM
120W 230V /
SILICONE HEATING
ELEMENT 6000MM
120W 230V



1101565 RESISTENZ
A 650W 8000MM /
HEATING ELEMENT
650W 8000MM



1101616 RESISTENZ
A ANTICONDENSA
SILICONE 20W
L1000mm /
HEATING ELEMENT
20W L1000mm



1101617 RESISTENZ
A ANTICONDENSA
SILICONE 30W
L1500mm /
HEATING ELEMENT
30W L1500mm



1101643 RESISTENZ
A MOD. CA 2000 220V
40W L 2000 MM /
HEATING ELEMENT
CA2000 220B 40W L
2000MM



1101407 RESIST.COR
N. PORTA -25W /
HEATING ELEMENT
FOR DOOR 25W
[CM33575119/0:](mailto:CM33575119@0)
CASTEL MAC SPA



1101360 RESISTENZ
A DI SCARICO 230V
50W L1000 /
HEATING ELEMENT
EXHAUST 230V 50W L.
1000



1101812 RESISTENZ
A FILO MS082-282E /
HEATING ELEMENT
WIRE MS082-282E
[LAR65014890 :](mailto:LAR65014890)
LAINOX ALI SPA



1101238 RESISTENZ
A EVAPORATORE
ZANUSSI 160W /
EVAPORATOR
HEATING ELEMENT
ZANUSSI
082733:
**ELECTROLUX
PROFESSIONAL
S.P.A.**

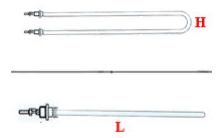

H=60mm, L=380mm

1101637 RESISTENZ
A ELETTRICA DI
SBRINAMENTO X EVS
40 MM. 365 /
HEATING ELEMENT
DEFROST EVS X 40
MM. 365

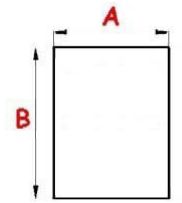

1101645 RESISTENZ
A SBRINAMENTO 750
W 230 V /
HEATING ELEMENT
750W 230V

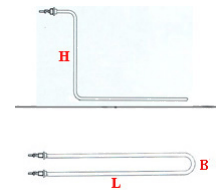

B=95mm, L=430mm,
H=98mm

1101786 RESISTENZ
A EVAPORATORE /
HEATING ELEMENT
EVAPORATOR
084726:
**ELECTROLUX
PROFESSIONAL
S.P.A.**

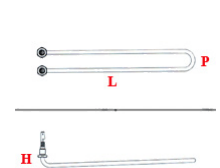

1101768 RESISTENZ
A 700 W 230 V ARF 2007
/
HEATING ELEMENT
700 W 230 V ARF 2007
R34638: ILSA SPA

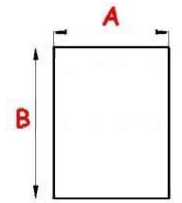

1106025 TERMOME
TRO DIGITALE
50+260° /
DIGITAL
THERMOMETER
50+260°
1106025:
UNIVERSALE



1106131 TERMOME
TRO INFRAROSSI -
18+260° /
INFRA-RED
THERMOMETER -
18+260°
:



4114354 ATTREZ.P
ORT.OSSIPROP.COMP
L.5LT /
COMPLETE
PORTABLE
EQUIPMENT
OXIGENPROP. 5LT
:



4114356 GRUPPO
MANOMETRICO PER
R 410 /
MANOMETRIC
GROUP FOR R 410
:



6103002 RIVELATO
RE DI FUGHE GAS S-
NOSE
MICROPROCESSORE
/
GAS LEAK
DETECTOR S-NOSE
MICROPROCESSOR
:



6103003 RILEVATO
RE DI FUGHE FREON
SNOSE /
GAS LEAK
DETECTOR FREON
SNOSE
:



6103016 BILANCIA
PER GAS PORTATA
MASSIMA 5 KG /
SCALE FOR GAS
MAX CAPACITY 5KG



6103007 LAMPADA
FLUORESCENTE RS-8
/
LAMPE RS-8
:



6103013 KIT
CHIAVI
DINAMOMETRICHE
Ø 17 - 22 - 26 - 29 /
DINAMOMETRIC
KEY KIT ? 17 - 22 - 26
- 29



Dati tecnici:

- Chiave mm. 17 (1/4) coppia Kg/ftm 180 (220 mm)
per gas R22 - R407C - R410A
- Chiave mm. 22 (3/8) coppia Kg/ftm 420 (265 mm)
per gas R22 - R407C - R410A
- Chiave mm. 26 (1/2) coppia Kg/ftm 550 (270 mm)
per gas R410A
- Chiave mm. 29 (5/8) coppia Kg/ftm 650 (335 mm)
per gas R410A

6103008 KIT
CERCAPERDITE GAS
/
GAS LEAK
DETECTOR KIT
:

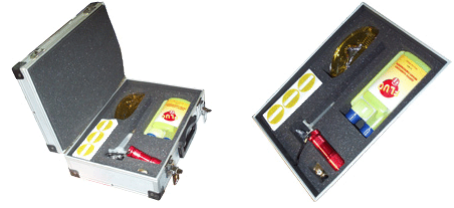

6103017 BOMBOLA
VUOTA DA KG.10 2
RUBINETTI /
EMPTY BOTTLE
FROM KG.10 2 TAPS

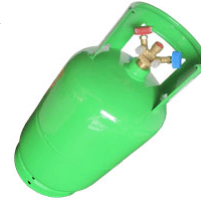

6103010 CESCOIE
PER GUARNIZIONE /
GASKET SHEAR





Corso Sempione 238/8 - 21052 Busto Arsizio -VA- Italy
phone 0039 0331 324053 - fax 0039 0331 671063

C.F. - P.IVA IT 02980880120

Società Unipersonale - Cap. Soc. € 10.000,00 i.v. - Iscr. Reg. Imprese di VA 02980880120

info@sep-spareparts.com -- www.sep-spareparts.com